

US00D809463S

(12) **United States Design Patent** (10) **Patent No.:** **US D809,463 S**
Koenig (45) **Date of Patent:** **** *Feb. 6, 2018**

(54) **ELECTRONIC CABLE**

(71) Applicant: **AP Specialties**, San Clemente, CA (US)

(72) Inventor: **Howard Koenig**, Dana Point, CA (US)

(73) Assignee: **AP Specialties**, San Clemente, CA (US)

(*) Notice: This patent is subject to a terminal disclaimer.

(**) Term: **14 Years**

(21) Appl. No.: **29/514,367**

(22) Filed: **Jan. 12, 2015**

(51) **LOC (11) Cl.** **13-03**

(52) **U.S. Cl.**
USPC **D13/147**

(58) **Field of Classification Search**
USPC D13/133, 147, 154, 184, 199; D14/432, D14/433, 435.1

(Continued)

(56) **References Cited**

U.S. PATENT DOCUMENTS

D594,418 S 6/2009 Fujino et al.
D684,539 S 6/2013 Akana et al.

(Continued)

FOREIGN PATENT DOCUMENTS

WO 2011150403 A1 12/2011

Primary Examiner — Daniel Bui

(74) *Attorney, Agent, or Firm* — Lerner, David, Littenberg, Krumholz & Mentlik, LLP

(57) **CLAIM**

The ornamental design for an electronic cable, as shown and described.

DESCRIPTION

FIG. 1 is a top plan view of Embodiment 1 of an electronic cable showing my new design;

FIG. 2 is a top plan view of Embodiment 2 of an electronic cable showing my new design;

FIG. 3 is a top plan view of Embodiment 3 of an electronic cable showing my new design;

FIG. 4 is a top plan view of Embodiment 4 of an electronic cable showing my new design;

FIG. 5 is a bottom perspective view of Embodiments 1 through 4 thereof;

FIG. 6 is a bottom plan view of Embodiments 1 through 4 thereof;

FIG. 7 is another bottom plan view of FIGS. 1 through 4, which corresponds to Embodiments 5 through 8 of an electronic cable showing my new design;

FIG. 8 is another bottom plan view of FIGS. 1 through 4, which corresponds to Embodiments 9 through 12 of an electronic cable showing my new design;

FIG. 9 is another bottom plan view of FIGS. 1 through 4, which corresponds to Embodiments 13 through 16 of an electronic cable showing my new design;

FIG. 10 is another bottom plan view of FIGS. 1 through 4, which corresponds to Embodiments 17 through 20 of an electronic cable showing my new design;

FIG. 11 is another bottom plan view of FIGS. 1 through 4, which corresponds to Embodiments 21 through 24 of an electronic cable showing my new design;

FIG. 12 is another bottom plan view of FIGS. 1 through 4, which corresponds to Embodiments 25 through 28 of an electronic cable showing my new design;

FIG. 13 is another bottom plan view of FIGS. 1 through 4, which corresponds to Embodiments 29 through 32 of an electronic cable showing my new design;

FIG. 14 is another bottom plan view of FIGS. 1 through 4, which corresponds to Embodiments 33 through 36 of an electronic cable showing my new design;

FIG. 15 is another bottom plan view of FIGS. 1 through 4, which corresponds to Embodiments 37 through 40 of an electronic cable showing my new design;

FIG. 16 is another bottom plan view of FIGS. 1 through 4, which corresponds to Embodiments 41 through 44 of an electronic cable showing my new design;

FIG. 17 is a bottom perspective view of Embodiments 41 through 44 thereof;

FIG. 18 is a front elevation view of Embodiments 1 through 44 thereof; and,

(Continued)

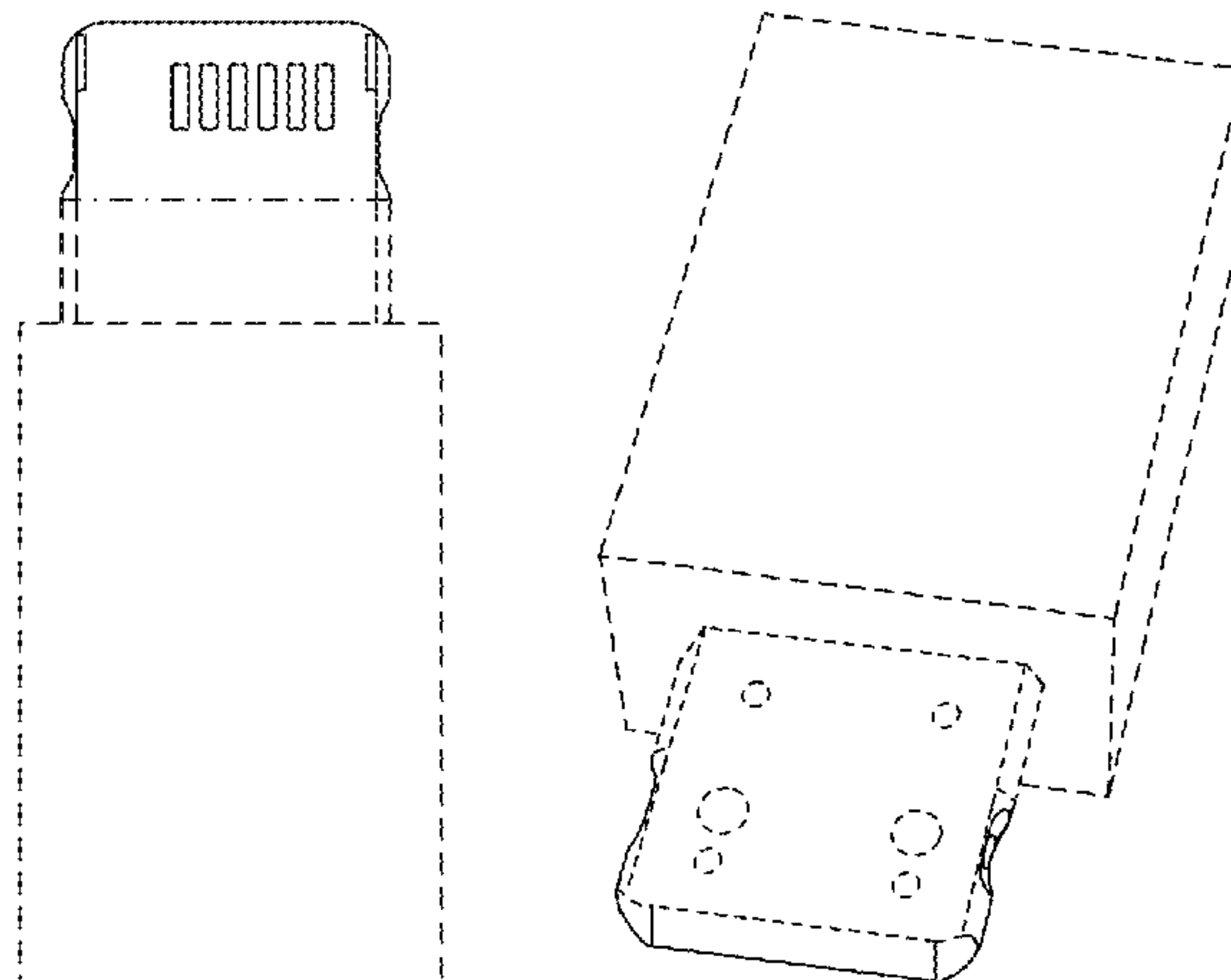

FIG. 19 is a left side elevation view of Embodiments 1 through 44, the right side elevation view being a mirror image thereof.

In the drawing views, the even-broken line represents unclaimed portions of the electronic cable that forms no part of the claimed design. The dash-dot line represents the boundary of the claimed design.

1 Claim, 6 Drawing Sheets

(58) **Field of Classification Search**

CPC H01R 24/60; H01R 24/70; H01R 13/5205;
 H01R 13/5219; H01R 13/642; H01R
 13/6471; H01R 13/6581; H01R 13/6582;
 H01R 13/6285; H01R 13/6591; H01R
 13/6596; H01R 13/656

See application file for complete search history.

(56) **References Cited**

U.S. PATENT DOCUMENTS

D684,976 S 6/2013 Akana et al.
 8,461,465 B2 6/2013 Golko et al.

8,561,879 B2	10/2013	Jol et al.	
D694,243 S	11/2013	Akana et al.	
D699,188 S	2/2014	Akana et al.	
D703,145 S	4/2014	Akana et al.	
D705,175 S	5/2014	Chu	
D705,176 S	5/2014	Akana et al.	
D707,680 S	6/2014	Akana et al.	
D707,681 S	6/2014	Akana et al.	
D713,350 S	9/2014	Akana et al.	
D713,351 S	9/2014	Akana et al.	
D713,352 S	9/2014	Akana et al.	
D713,353 S	9/2014	Akana et al.	
D713,354 S	9/2014	Akana et al.	
D716,234 S	10/2014	Tien	
D716,235 S	10/2014	Tien	
D733,658 S *	7/2015	Yang	D13/147
D745,464 S *	12/2015	Koenig	D13/147
D751,989 S *	3/2016	Imai	D13/147
2014/0073193 A1 *	3/2014	SooHoo	G06F 1/1626 439/661
2014/0136863 A1	5/2014	Fritchman et al.	
2015/0072557 A1 *	3/2015	Kamei	H01R 24/60 439/607.02
2015/0340782 A1 *	11/2015	Amini	H01R 12/71 439/629
2015/0364888 A1 *	12/2015	Yu	H01R 13/6585 264/250

* cited by examiner

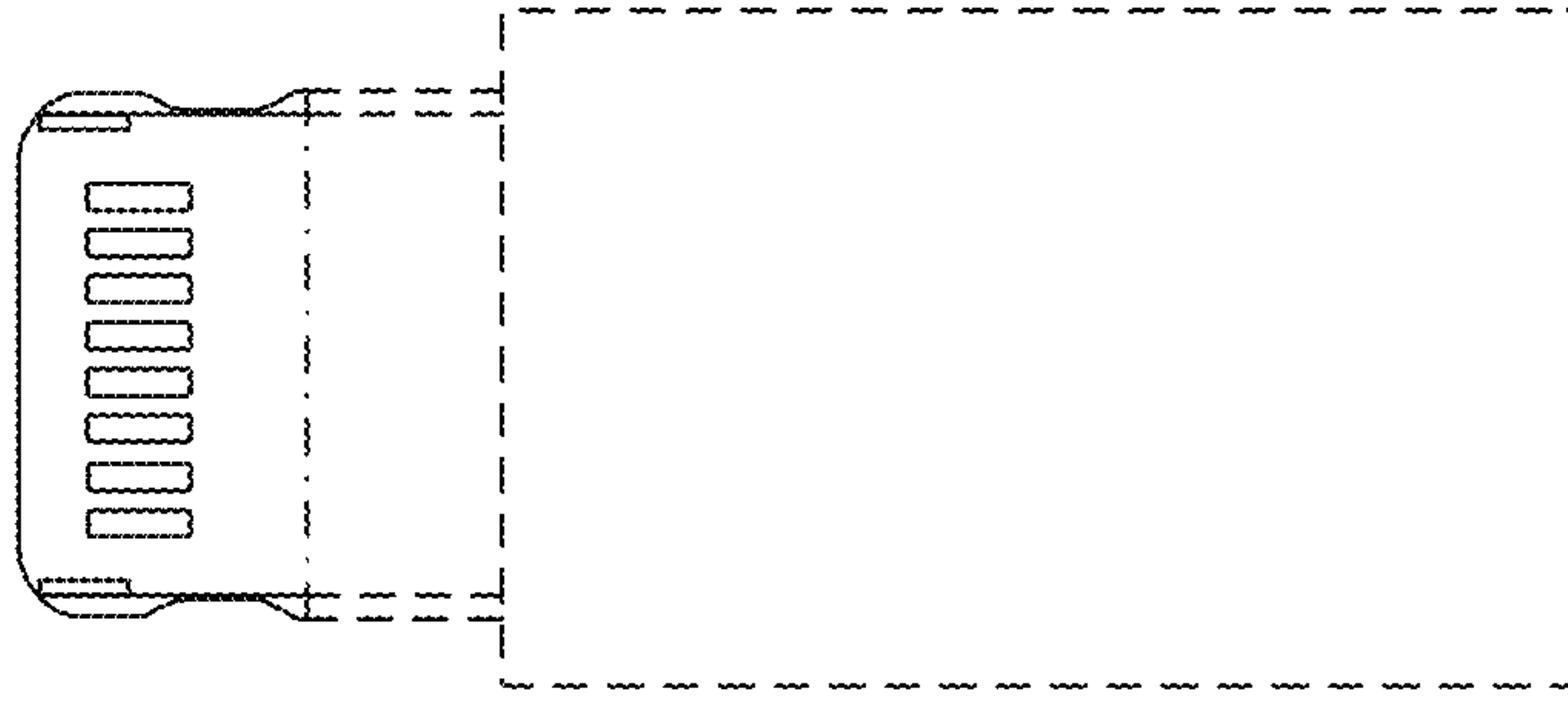

FIG. 1

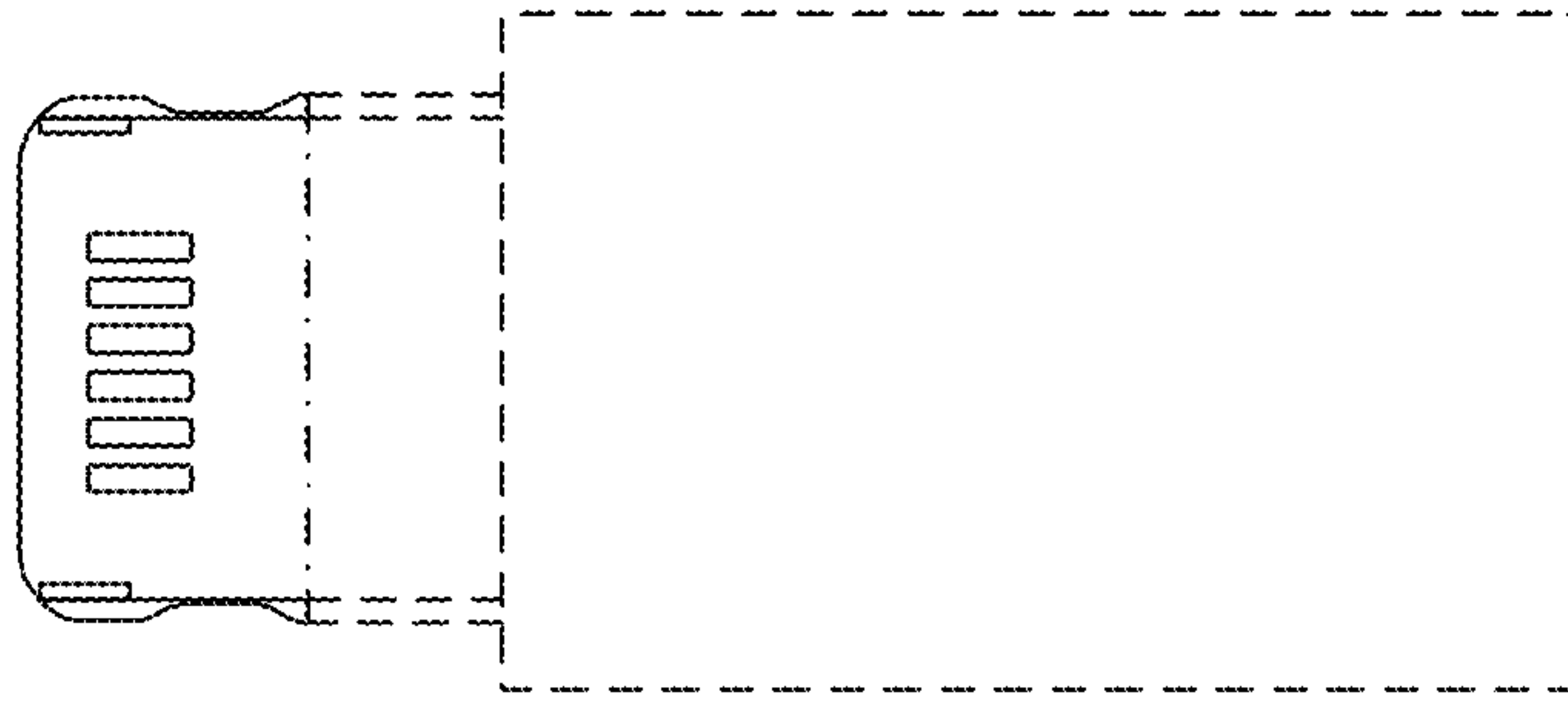

FIG. 2

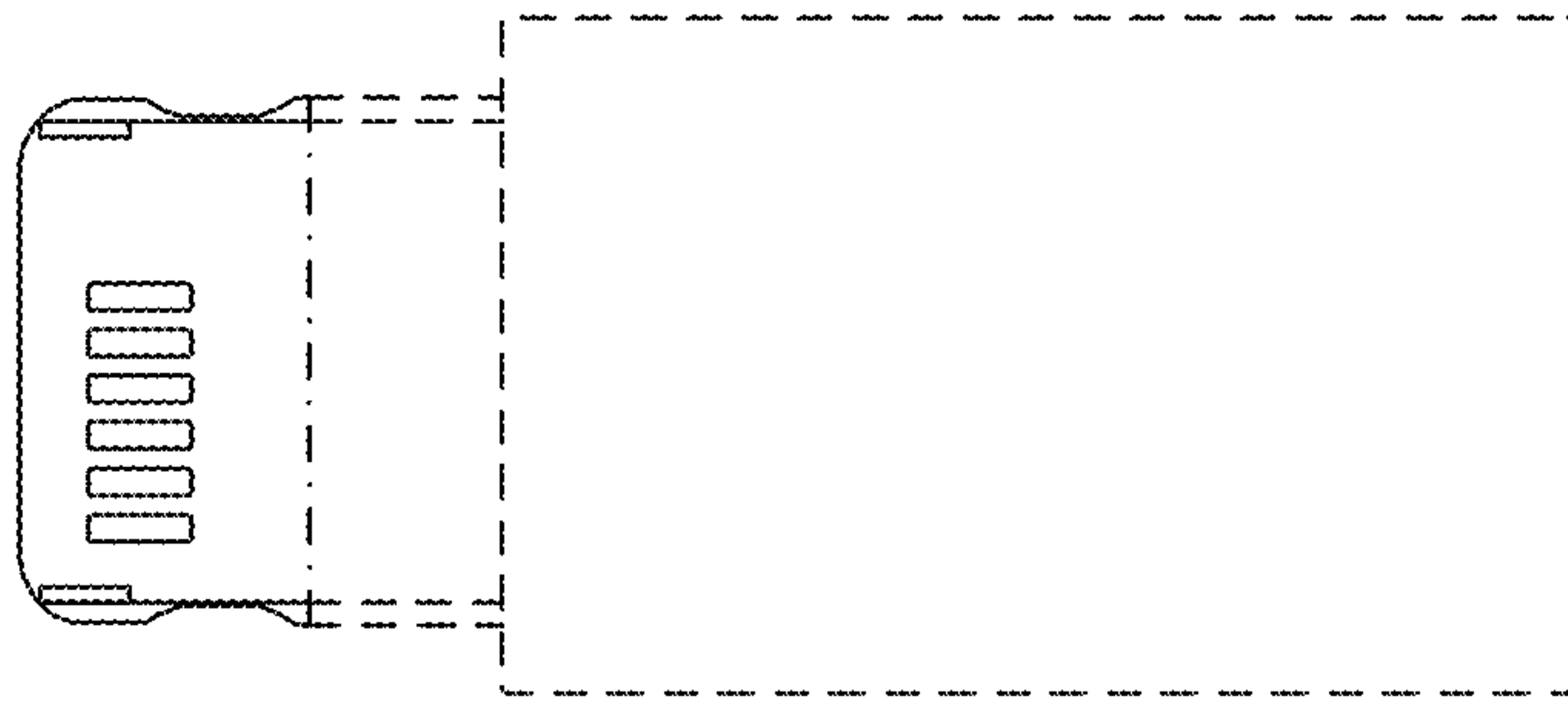

FIG. 3

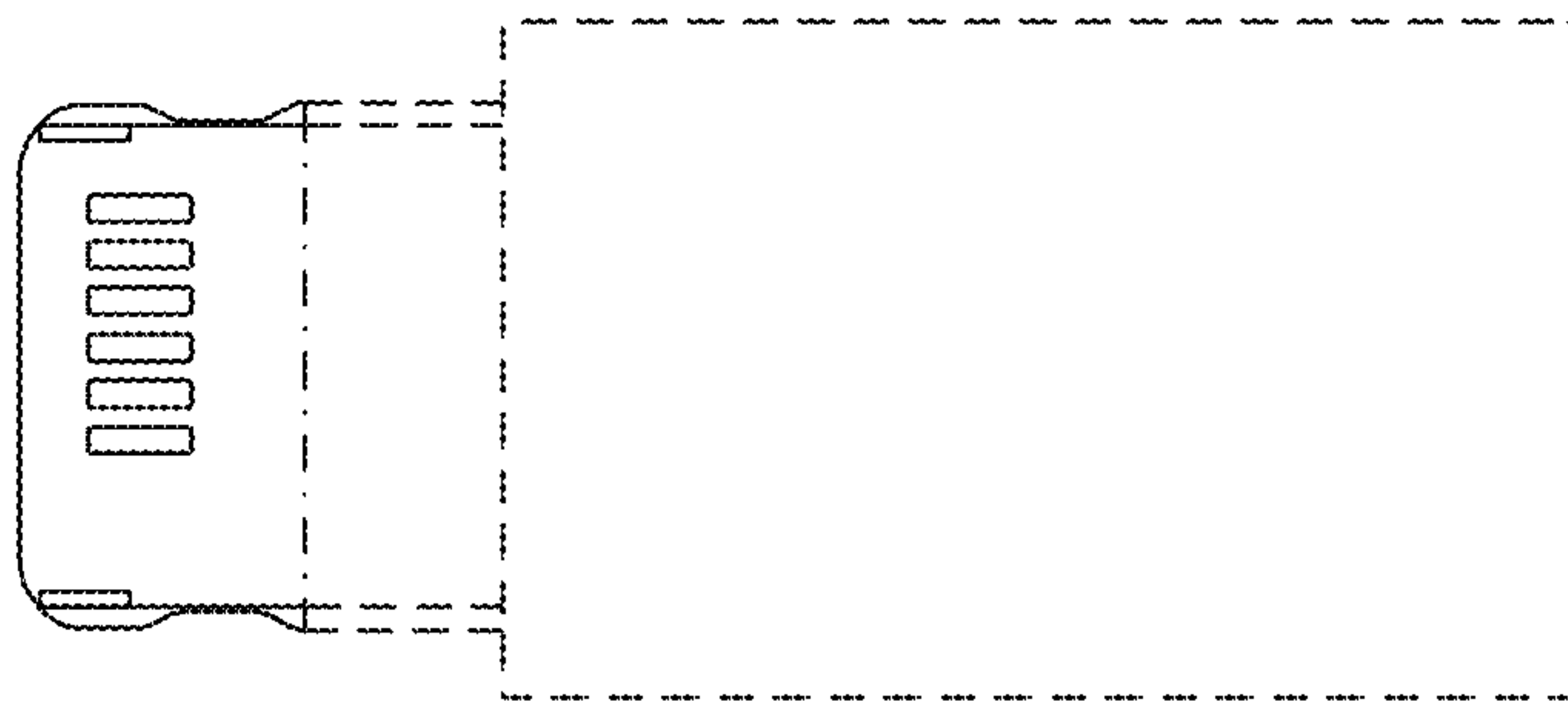

FIG. 4

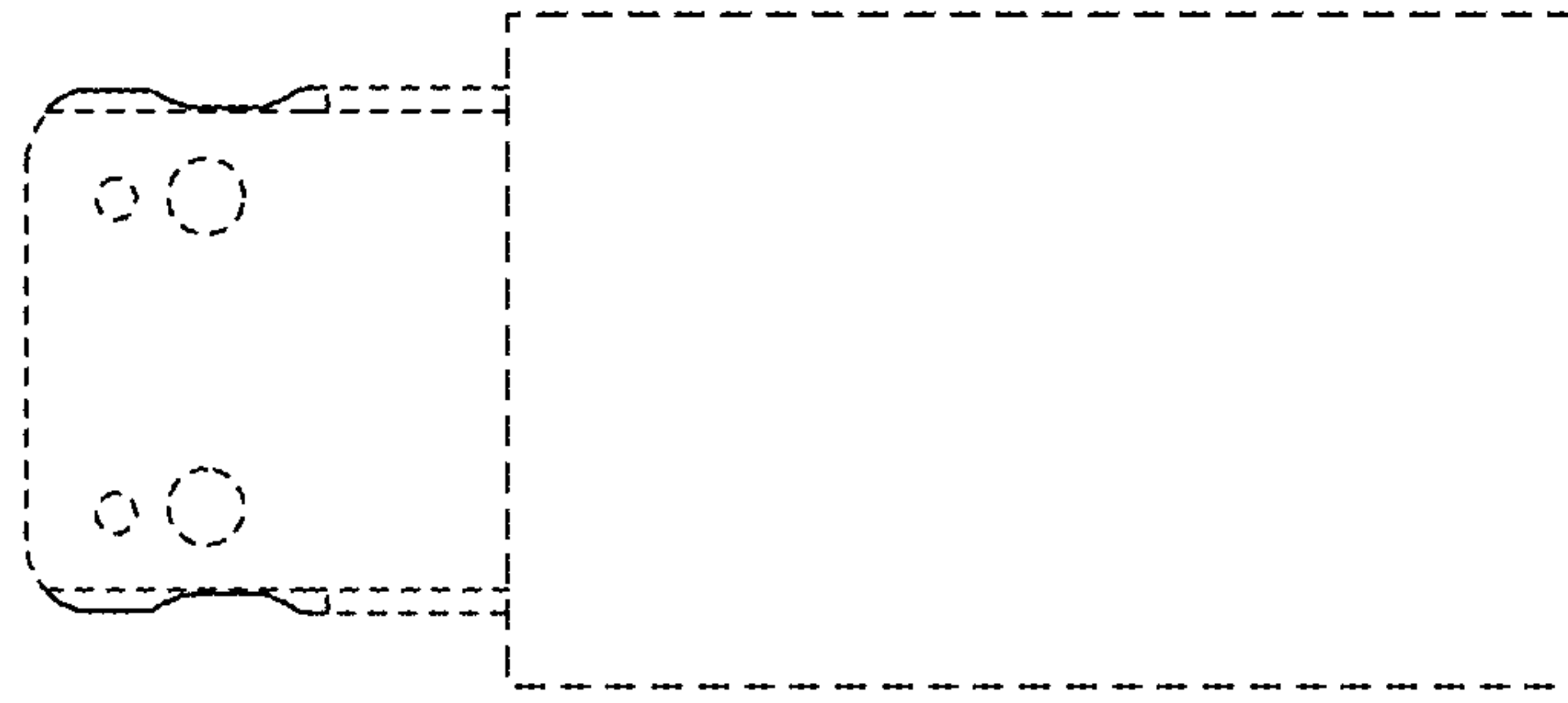

FIG. 5

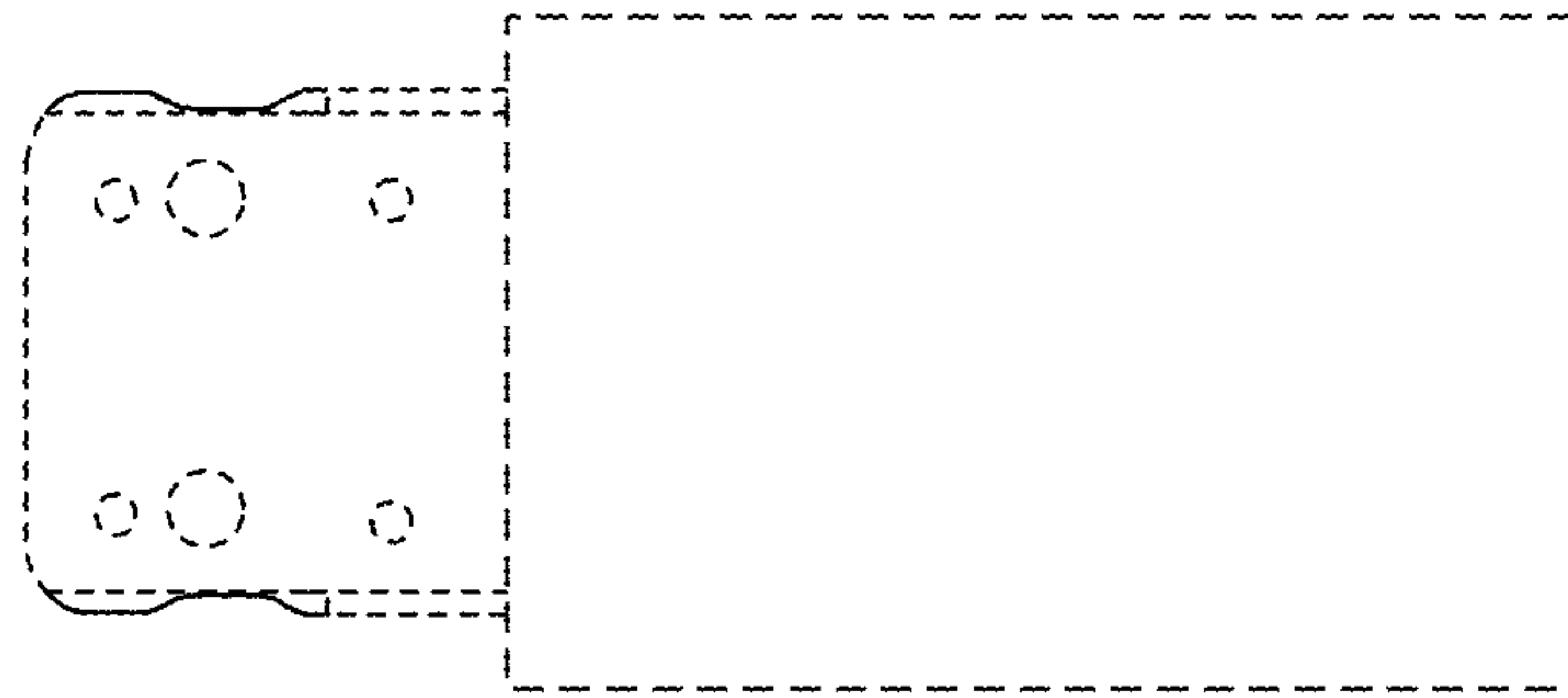

FIG. 6

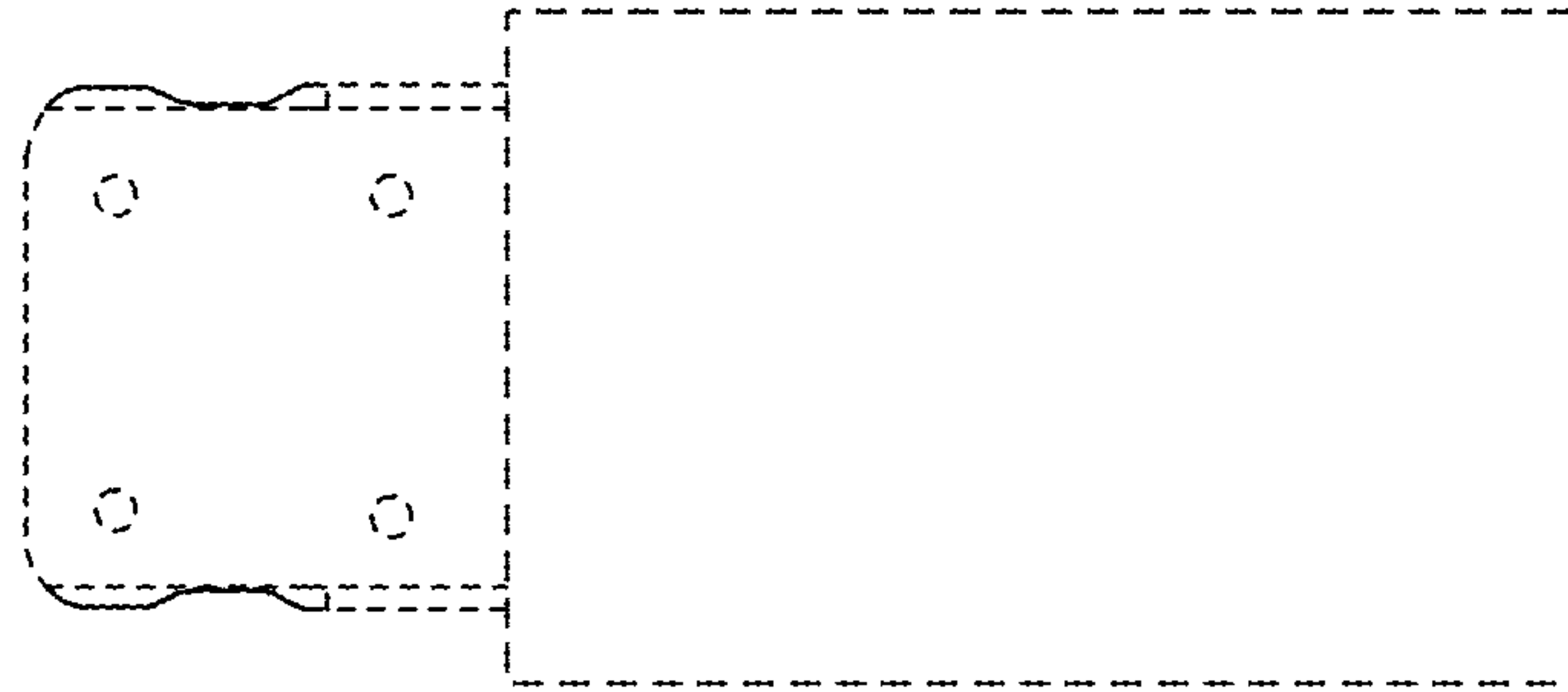

FIG. 7

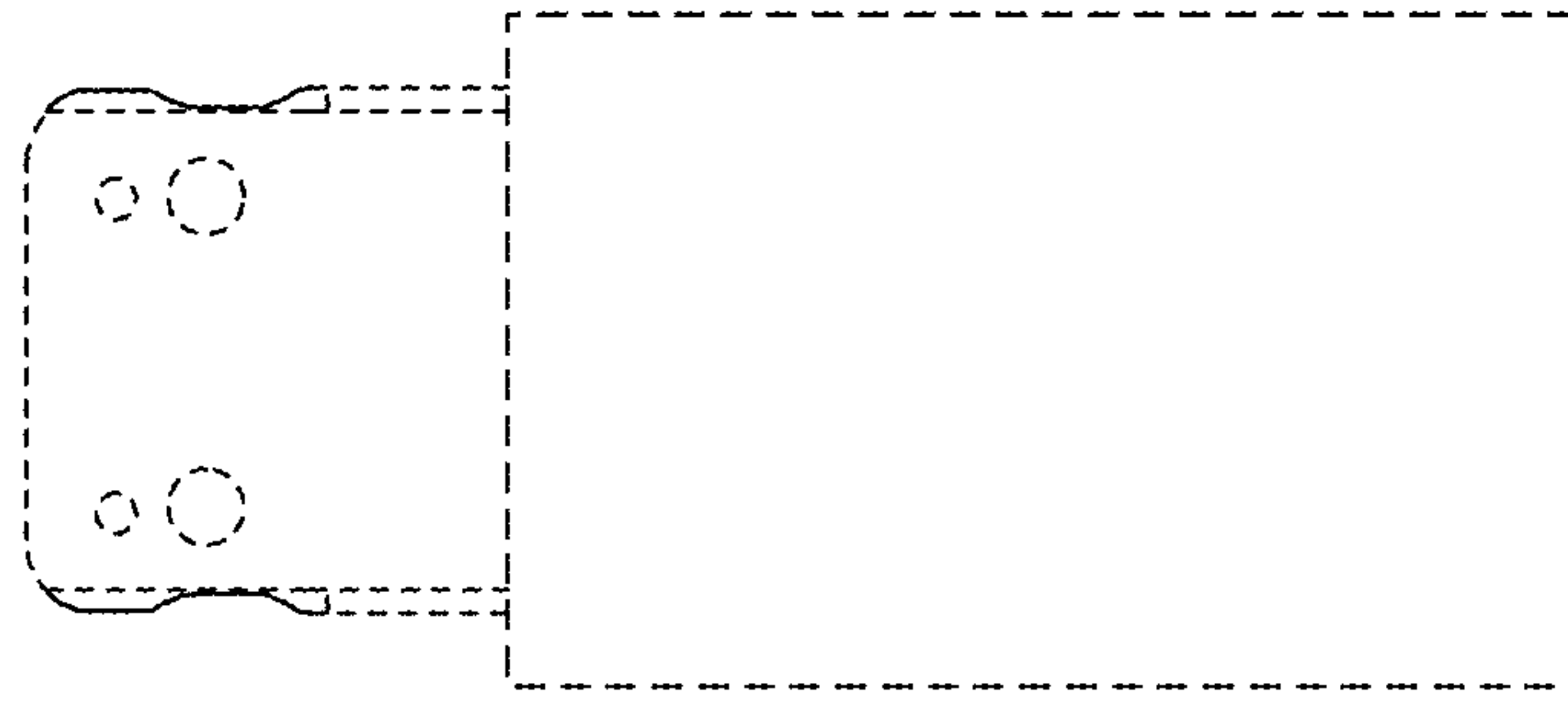

FIG. 8

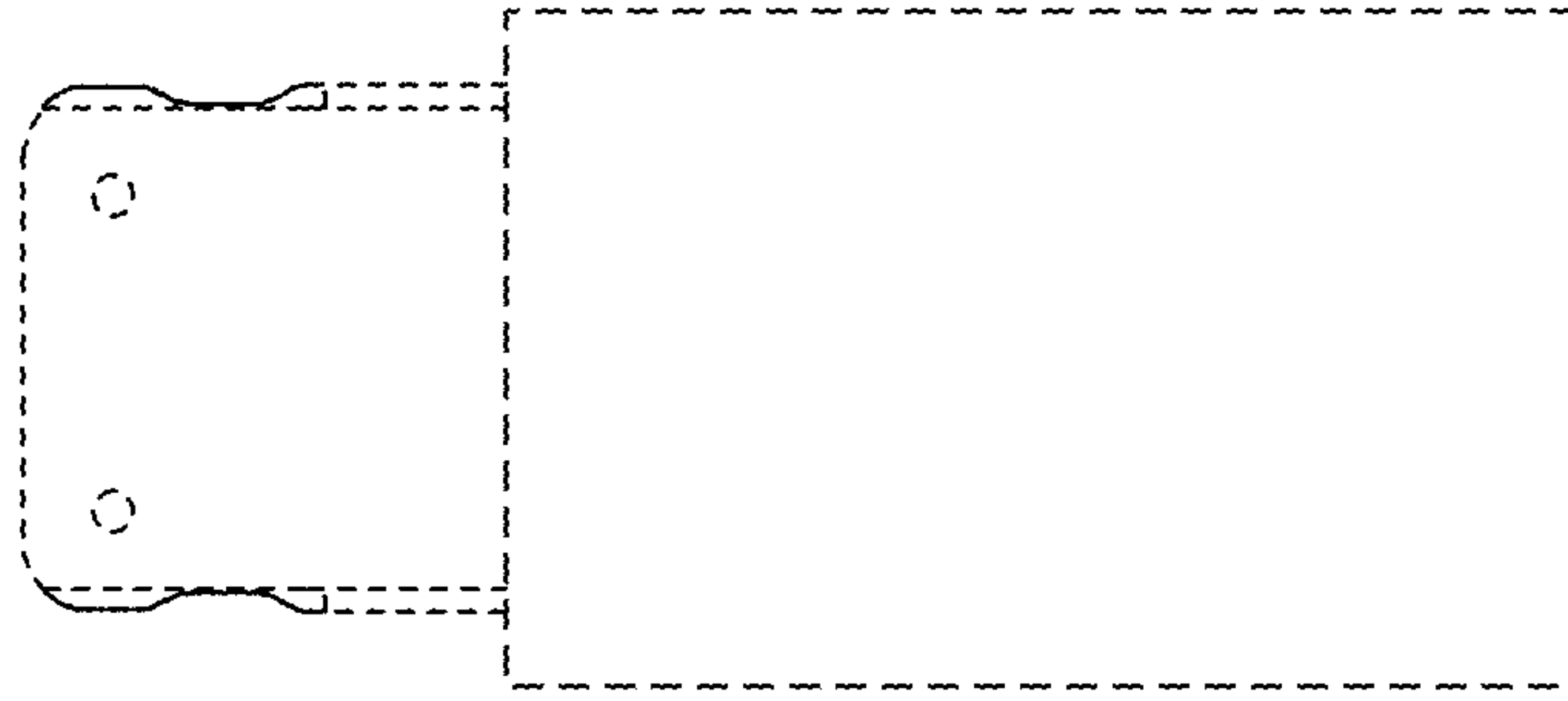

FIG. 9

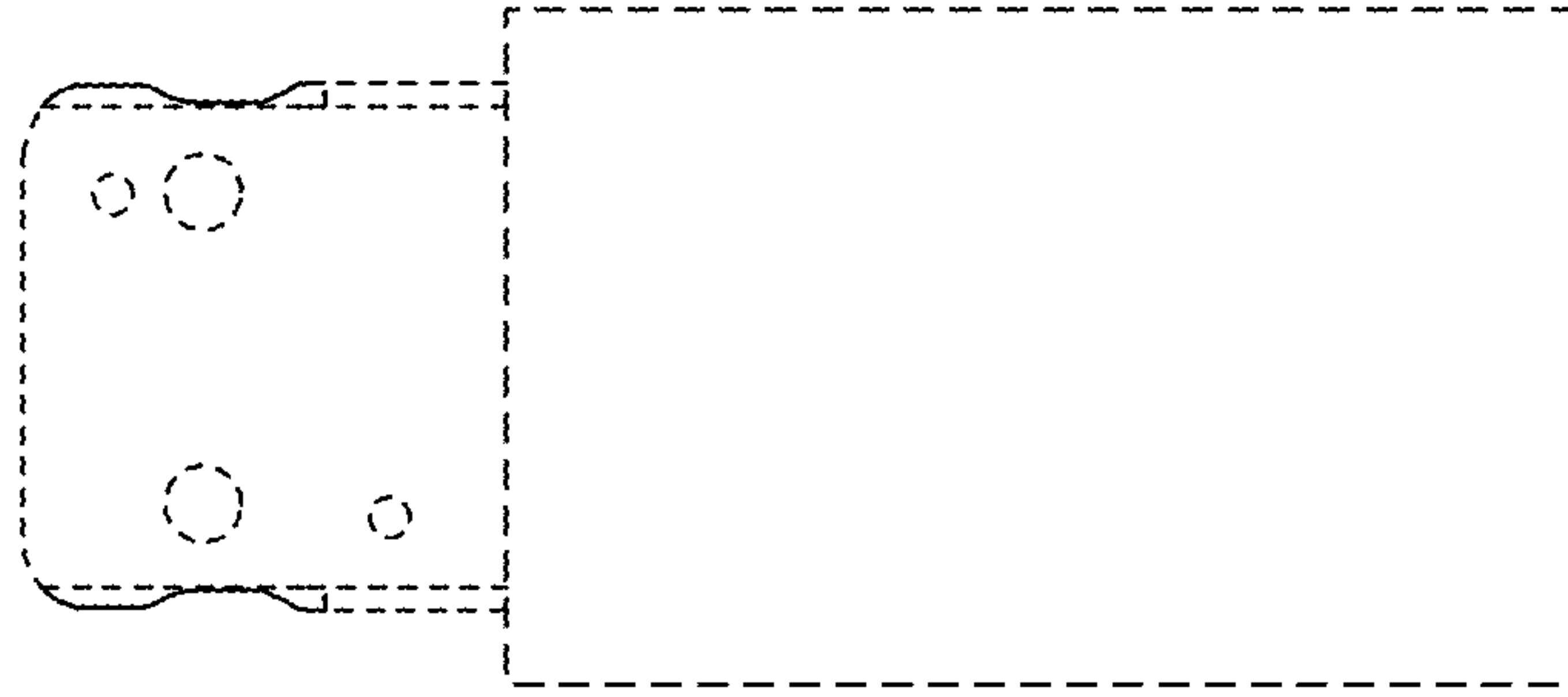

FIG. 10

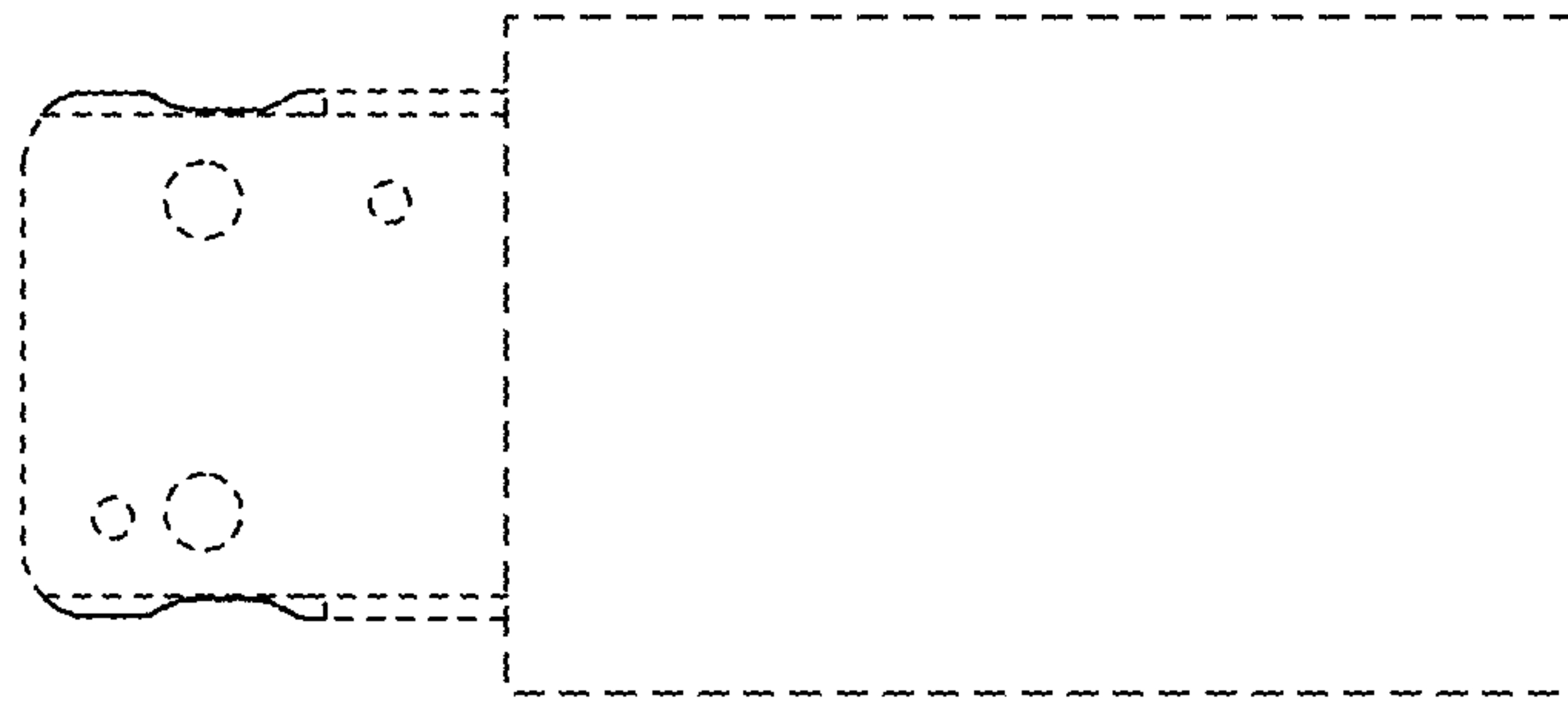

FIG. 11

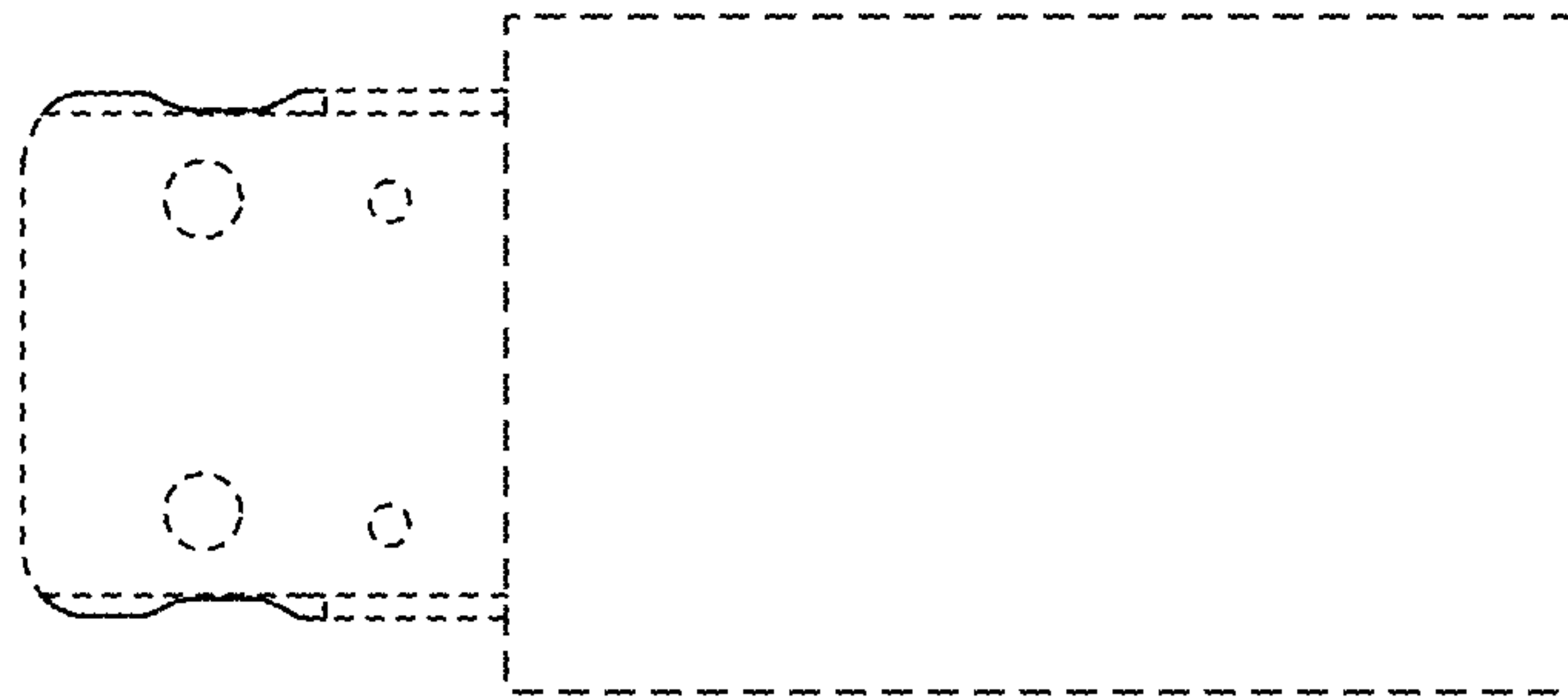

FIG. 12

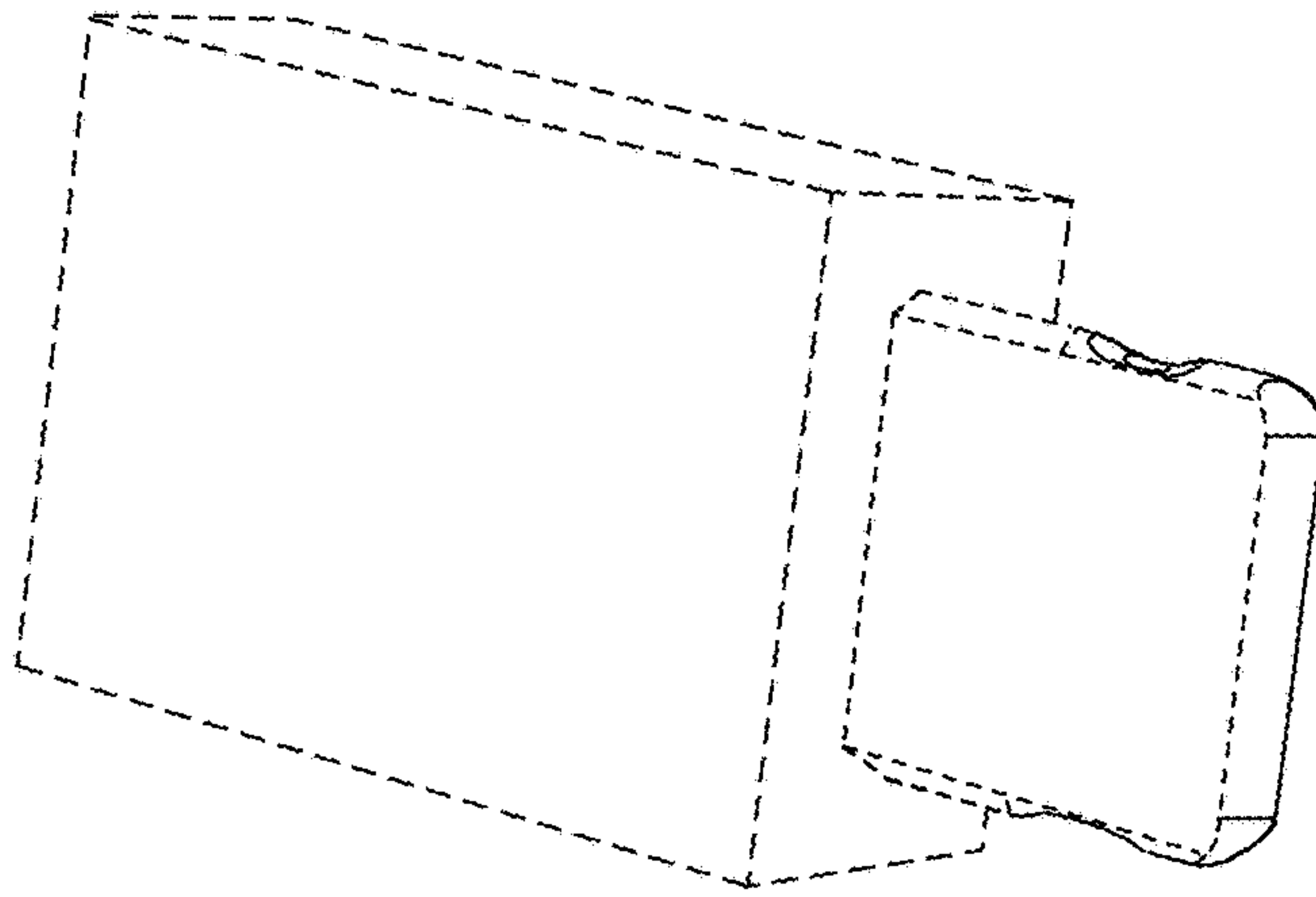

FIG. 17

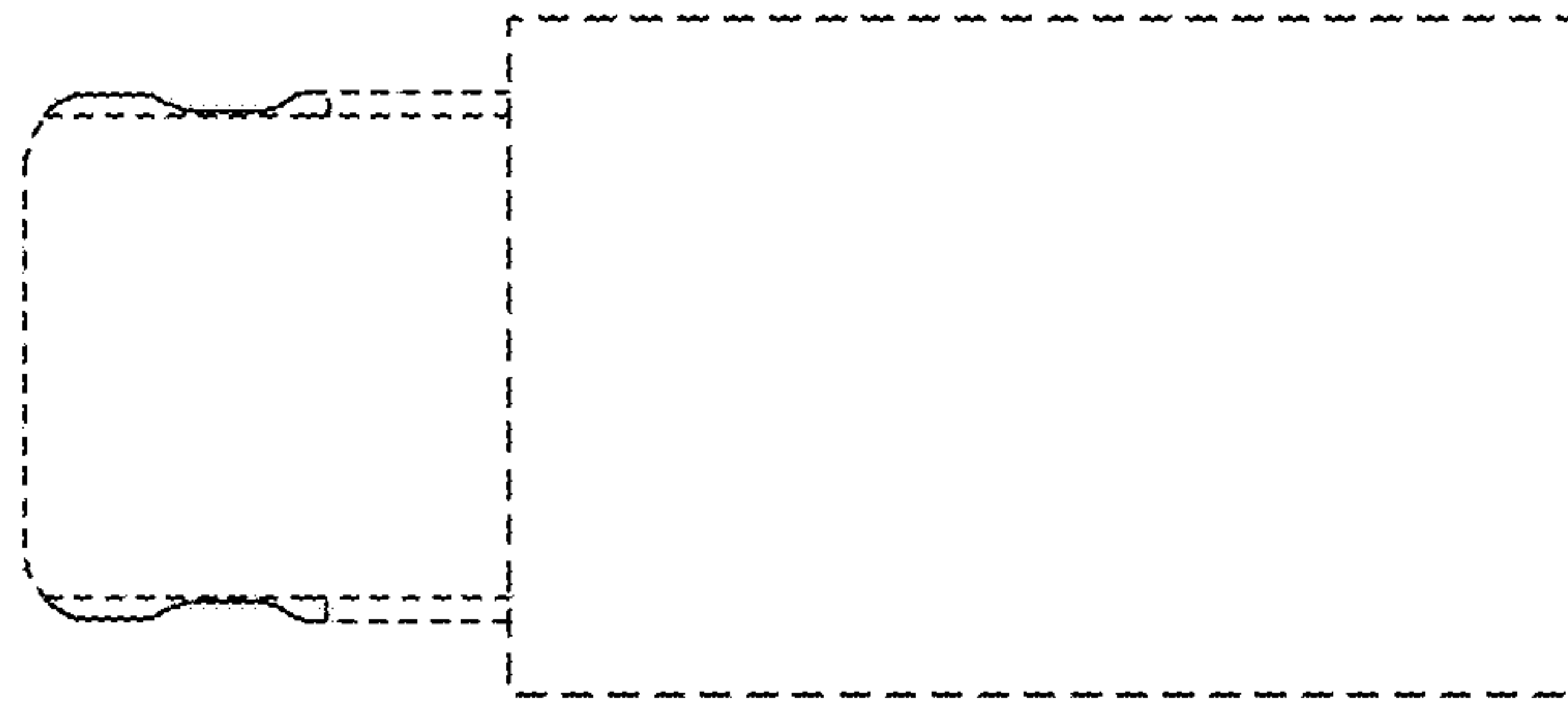

FIG. 16

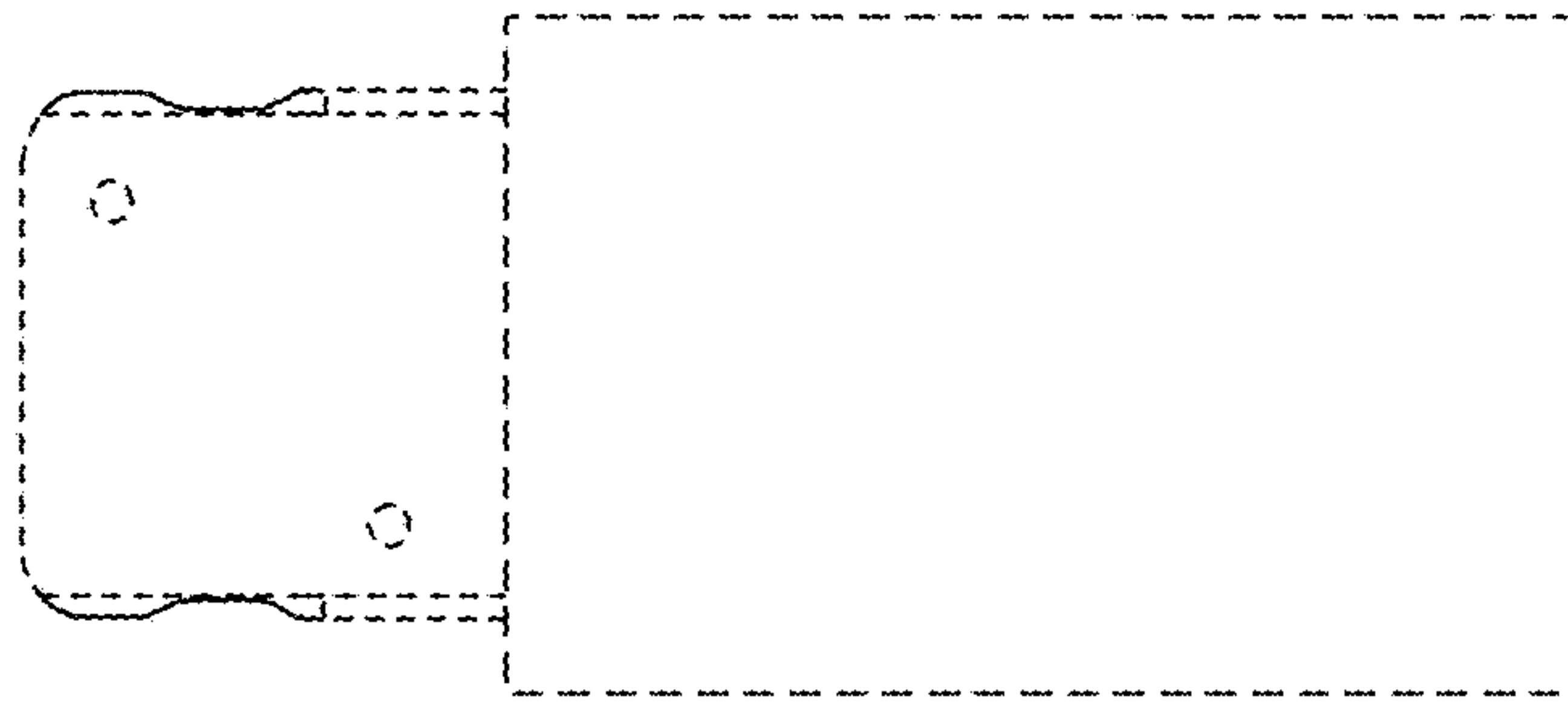

FIG. 15

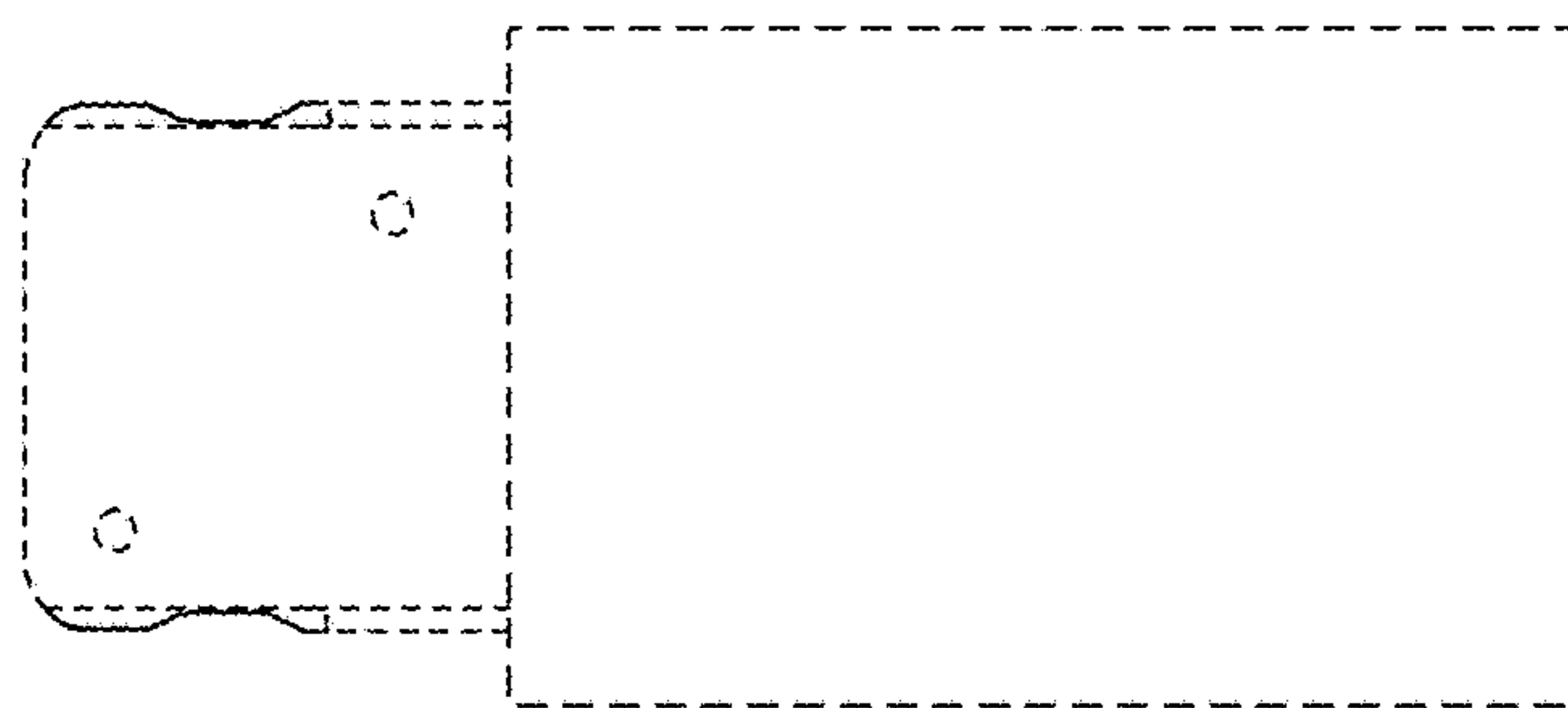

FIG. 14

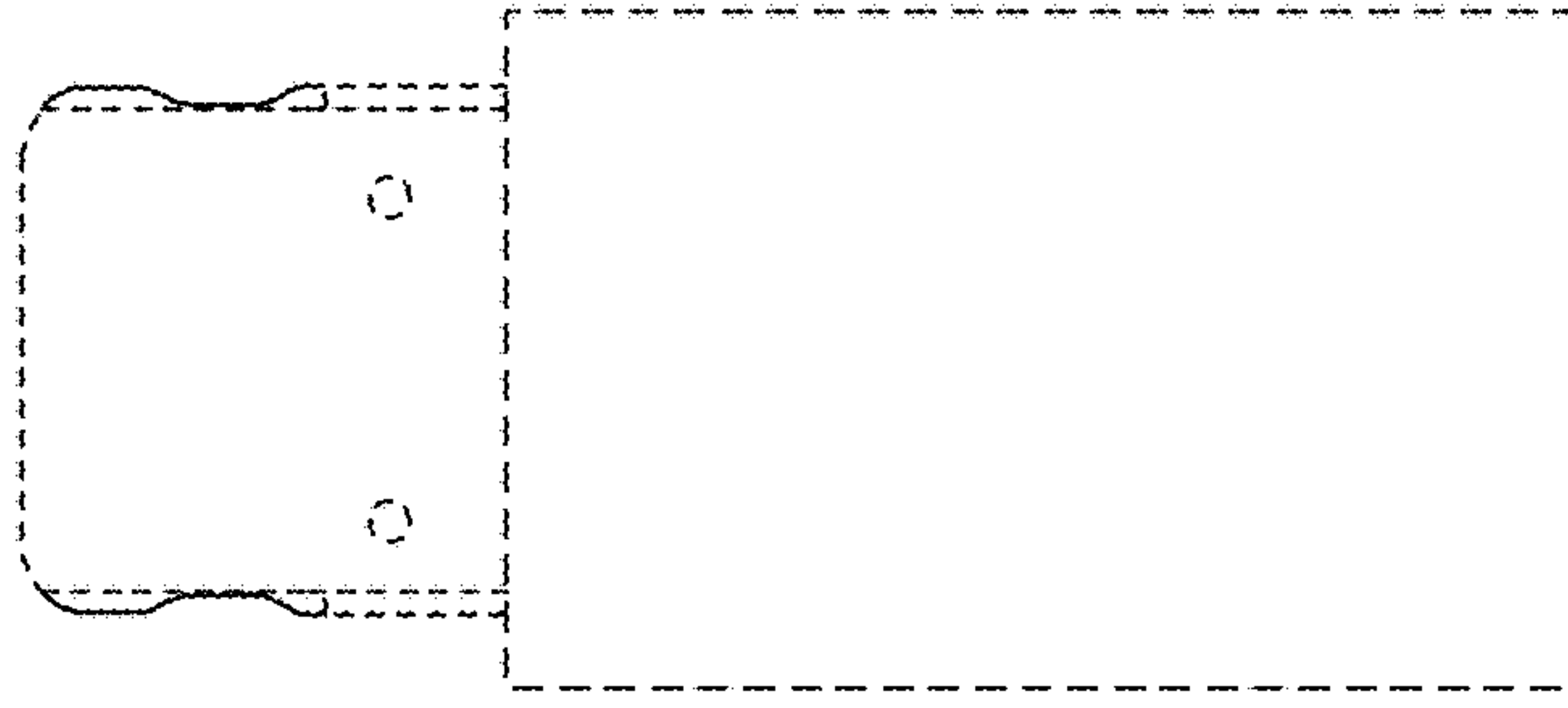

FIG. 13

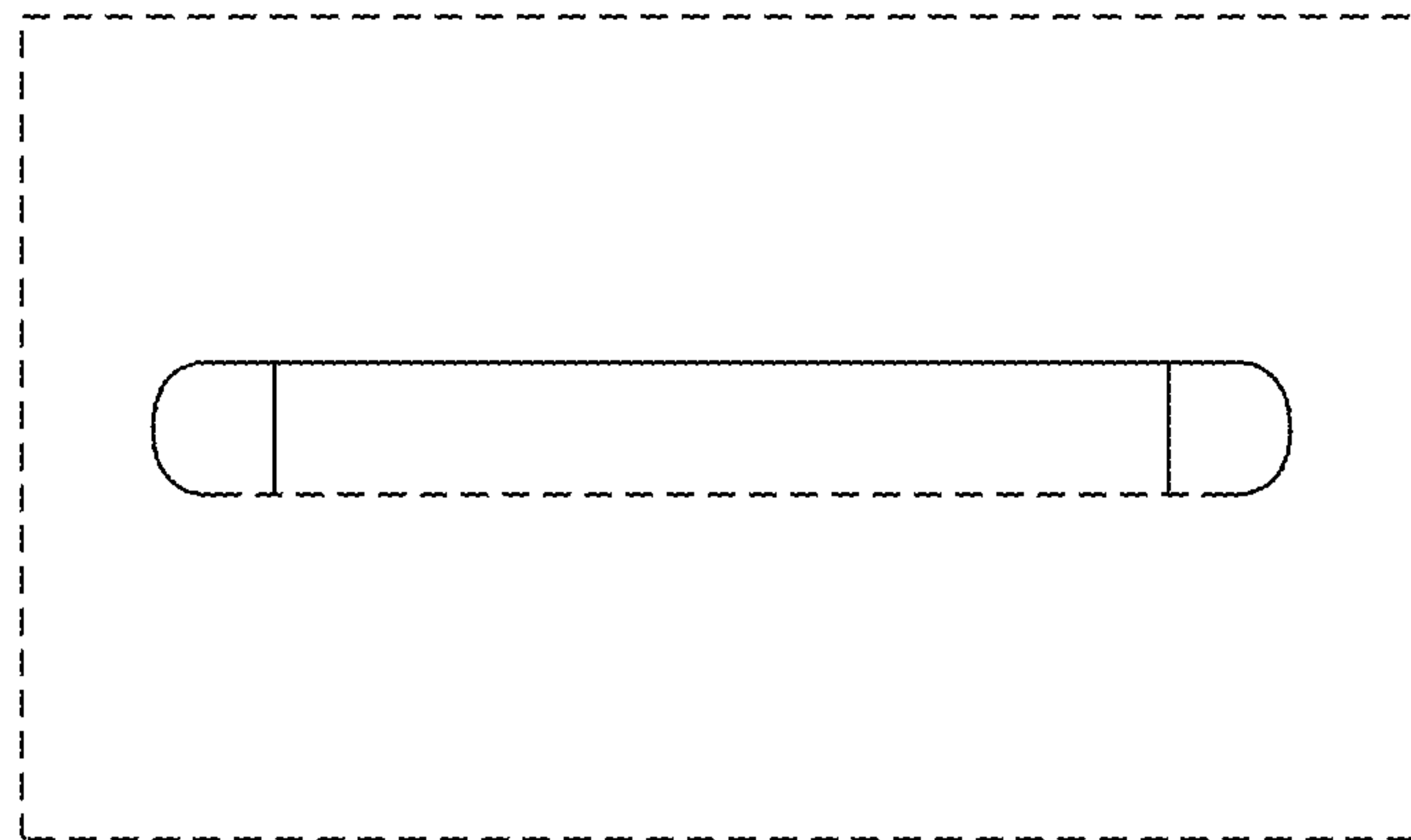

FIG. 18

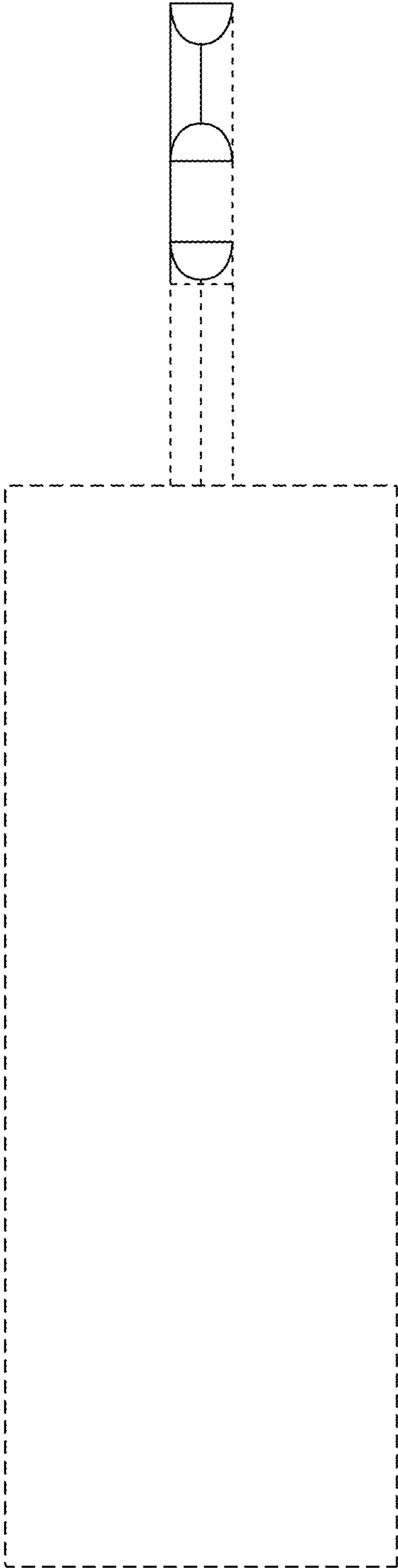

FIG. 19