



US00D809444S

(12) **United States Design Patent** (10) **Patent No.:** **US D809,444 S**
Nathan et al. (45) **Date of Patent:** **** Feb. 6, 2018**

(54) **HEART SHAPED FRAME FOR LICENSE PLATES AND PICTURES**

D592,408 S * 5/2009 Kuchinsky D6/308
D610,061 S * 2/2010 Johnson D12/193
D612,782 S * 3/2010 Johnson D12/193
D706,179 S * 6/2014 Pochurek D12/162
D725,547 S * 3/2015 Agule D11/157

(71) Applicants: **Reuben D. Nathan**, Newport Beach, CA (US); **Neil Mason**, Newport Beach, CA (US)

(72) Inventors: **Reuben D. Nathan**, Newport Beach, CA (US); **Neil Mason**, Newport Beach, CA (US)

(**) Term: **14 Years**

(21) Appl. No.: **29/514,038**

(22) Filed: **Jan. 8, 2015**

(51) **LOC (11) Cl.** **12-16**

(52) **U.S. Cl.**
USPC **D12/193**

(58) **Field of Classification Search**
USPC D12/162, 193; D6/300, 301, 302, 310, D6/311, 312, 313, 314; D11/134, 121, D11/158; D20/13
CPC B60R 13/10; B60R 13/105; A42B 3/00; A42B 3/04; A42B 3/18; A42B 3/20; A42B 3/22; A42B 3/225; A63B 29/00; A63B 71/08; A63B 71/10

See application file for complete search history.

(56) **References Cited**

U.S. PATENT DOCUMENTS

D423,570 S * 4/2000 Moyal D19/20
D428,054 S * 7/2000 Hayashi D19/21
D441,547 S * 5/2001 Hayashi D19/21
D448,276 S * 9/2001 Kelleghan 24/573.11
D517,229 S * 3/2006 Wernimont D26/31
D529,746 S * 10/2006 Soleymani D6/303
D534,478 S * 1/2007 Valeri D12/400

OTHER PUBLICATIONS

2.4" 16MB Heart Shaped LCD Digital Photo Frame Red, posted on tmart.com, earliest product review on Jul. 12, 2011, no production date given, [online], [site visited Aug. 25, 2016], Available from Internet, <URL: http://www.tmart.com/2.4-16MB-Red-Heart-Shaped-LCD-Digital-Photo-Frame_p90888.html>.*

(Continued)

Primary Examiner — Melanie H Tung
Assistant Examiner — Fritzgerald Butac
(74) *Attorney, Agent, or Firm* — William L. Chapin

(57) **CLAIM**

The ornamental design for a heart shaped frame for license plates and pictures, as shown and described.

DESCRIPTION

FIG. 1 is a front perspective view of a heart shaped frame for license plates and pictures according to the present invention, showing the frame attached to a vehicle and holding a picture.

FIG. 2 is another front perspective view thereof.
FIG. 3 is a front elevation view thereof.
FIG. 4 is another front elevation view thereof.
FIG. 5 is a rear elevation view thereof.
FIG. 6 is a right side elevation view thereof.
FIG. 7 is a top plan view thereof; and,
FIG. 8 is a bottom plan view thereof.

The broken line showing of a vehicle in FIG. 1, and pictured in FIGS. 1 and 3, show environmental structure and form no part of the claimed design.

1 Claim, 5 Drawing Sheets

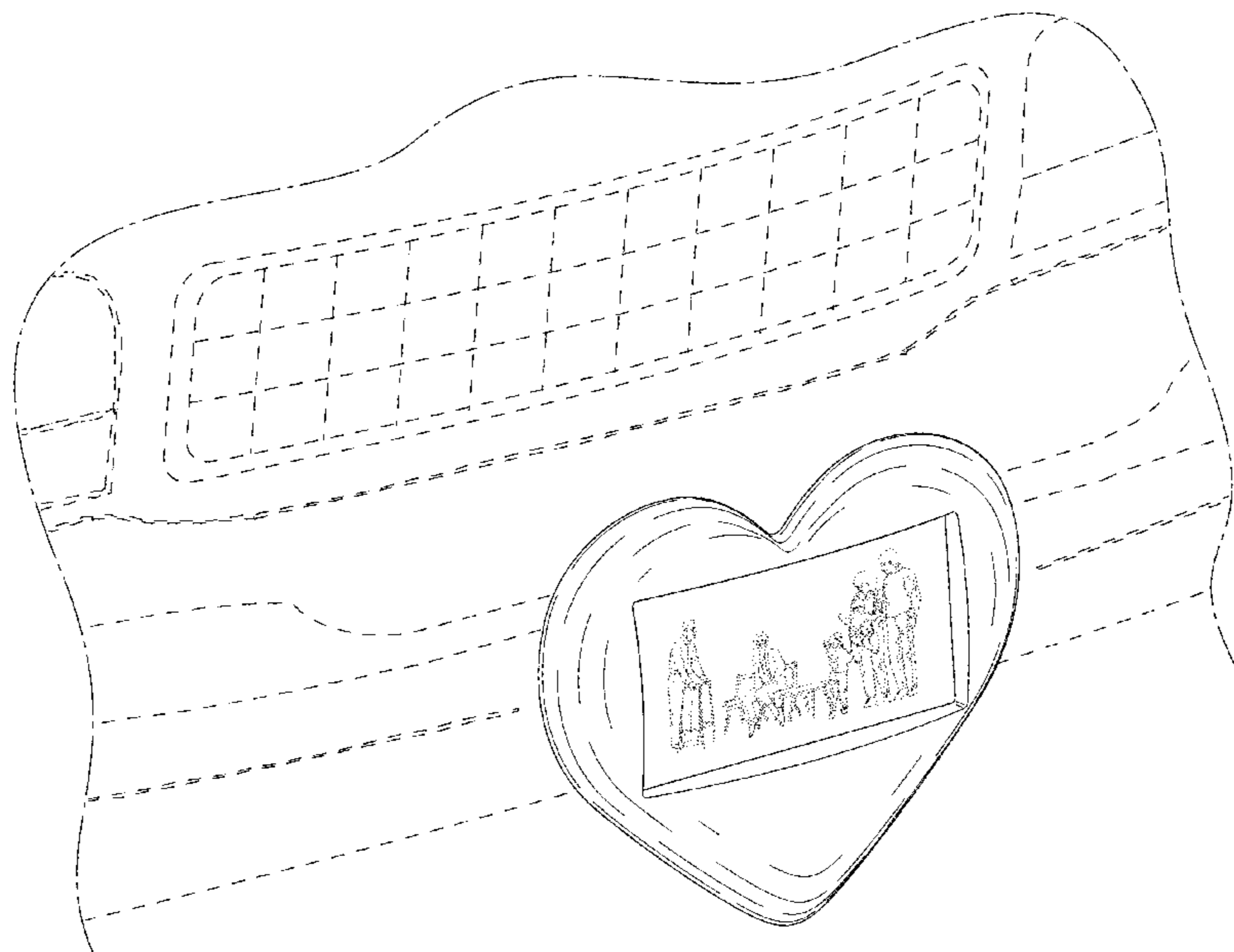

(56)

References Cited

OTHER PUBLICATIONS

Red Heart Photo Frame, posted on lulusoso.com, Posted Mar. 19, 2012, no production date given, [online], [site visited Aug. 25, 2016], Available from Internet: <URL: <http://sell.lulusoso.com/selling-leads/1016647/red-heart-photo-frame.html>>.*

Heart Picture Frame, posted on runnerduck.com, posted in the AllAmerican RunnerDuck Newsletter on Feb. 7, 2003, no production date given, [online], [site visited on Aug. 25, 2016], Available from Internet, <URL: http://www.runnerduck.com/heart_frame.htm>.*

Big Red Heart Photo Frame, posted on thegiftexperience.co.uk, no posted date given, no production date given, [online], [site visited Aug. 25, 2016], Available from Internet: <URL: <https://www.thegiftexperience.co.uk/catalogue/big-red-heart-photo-frame/index.html>>.*

* cited by examiner

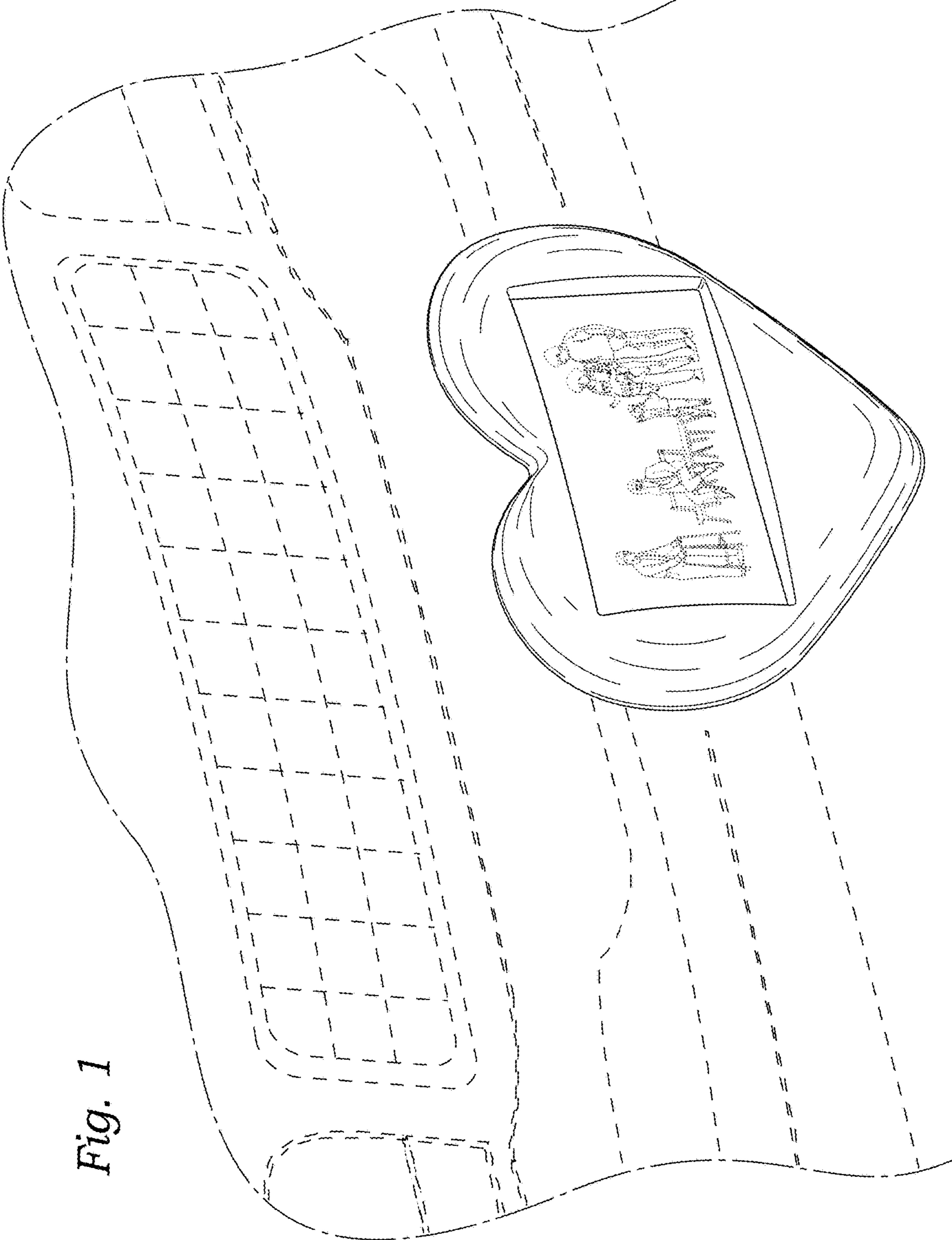

Fig. 1

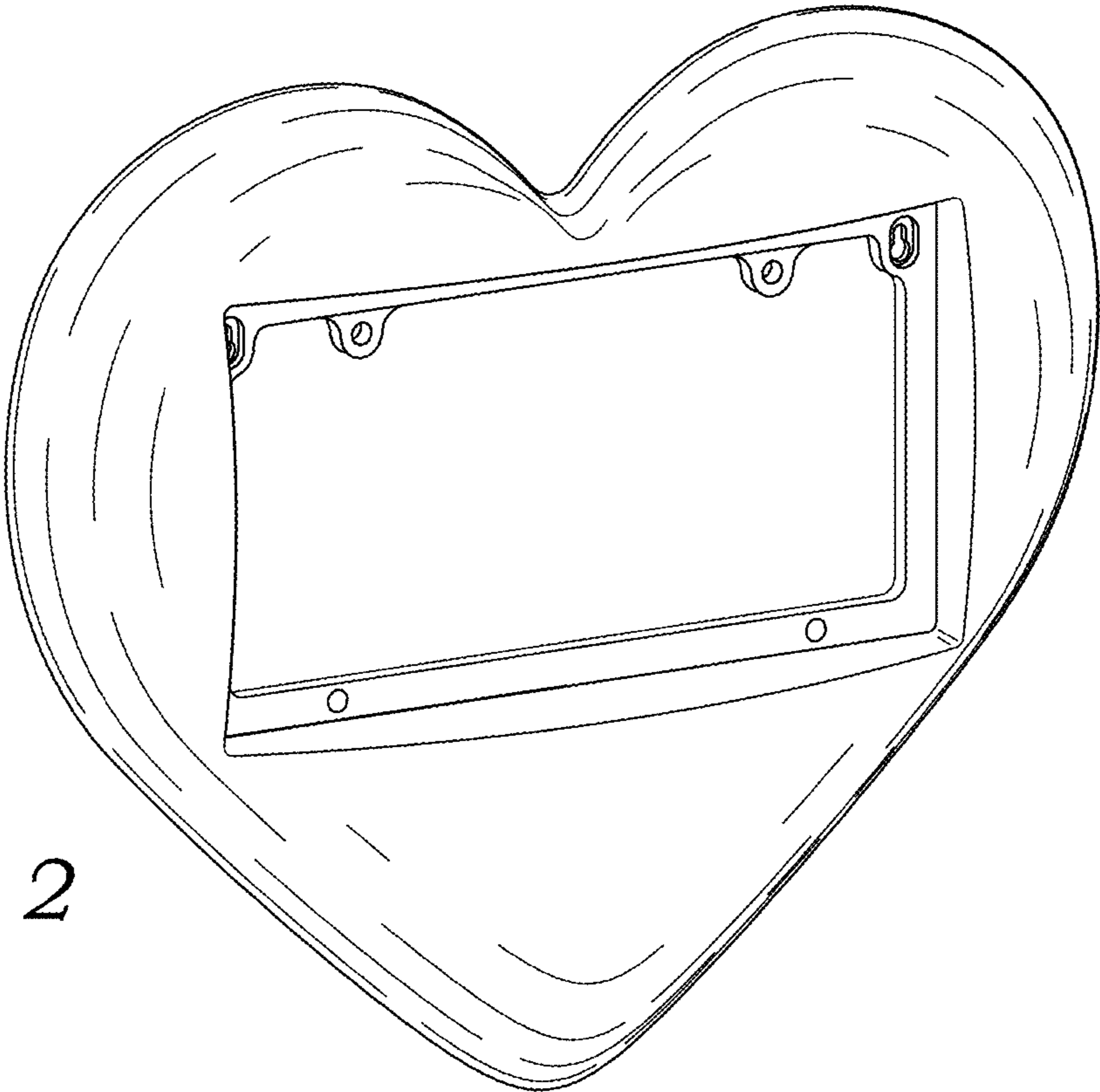

Fig. 2

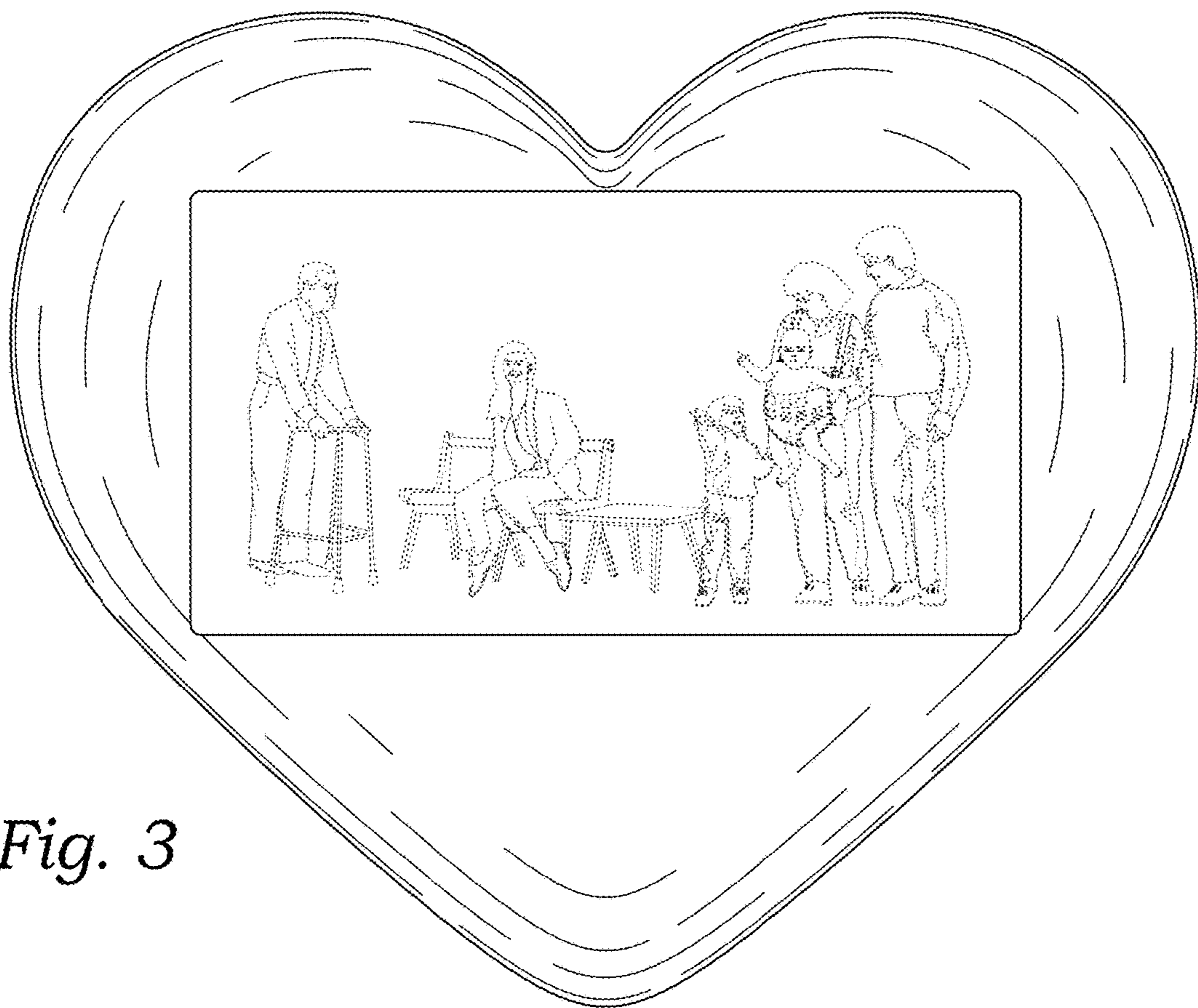

Fig. 3

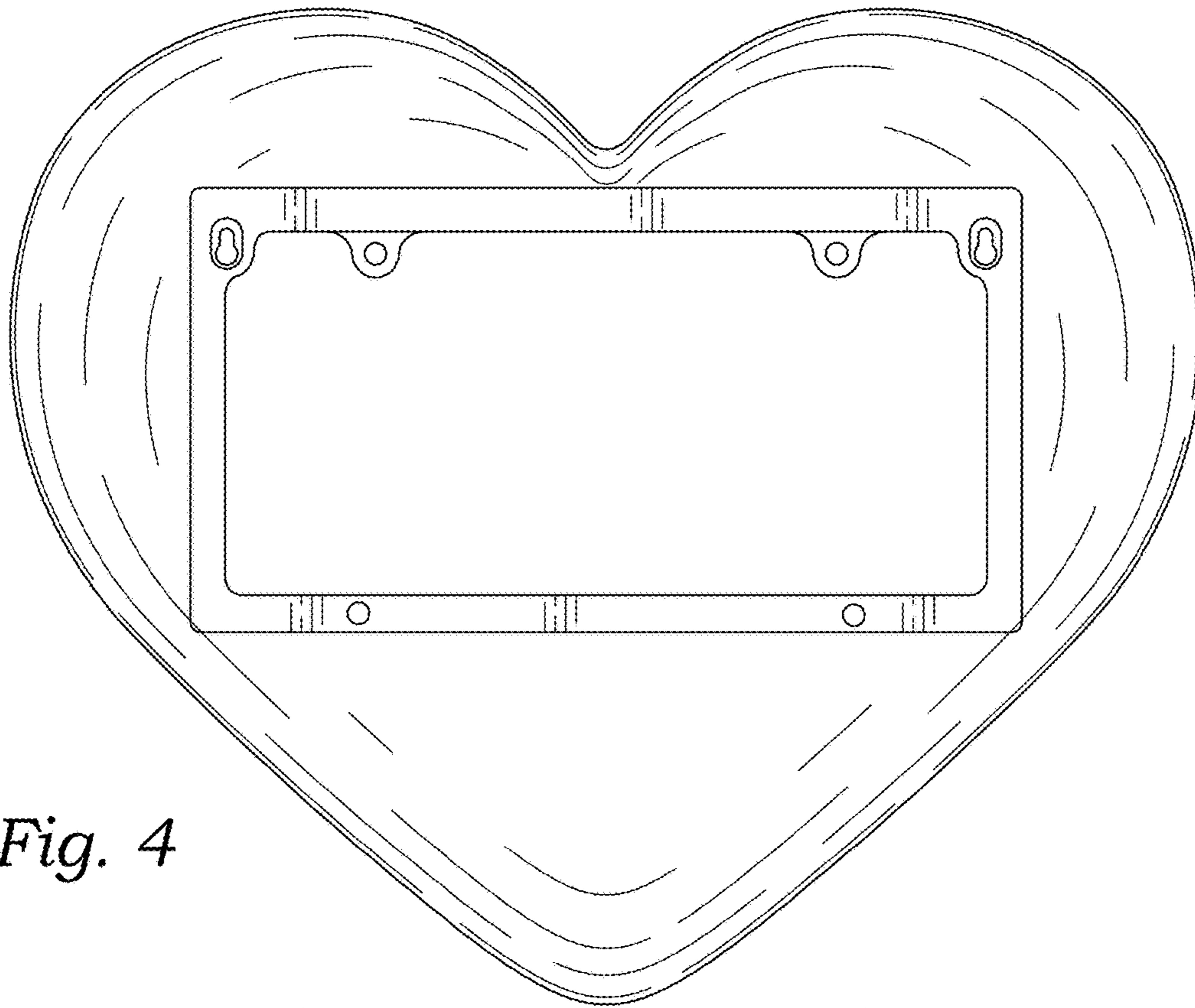

Fig. 4

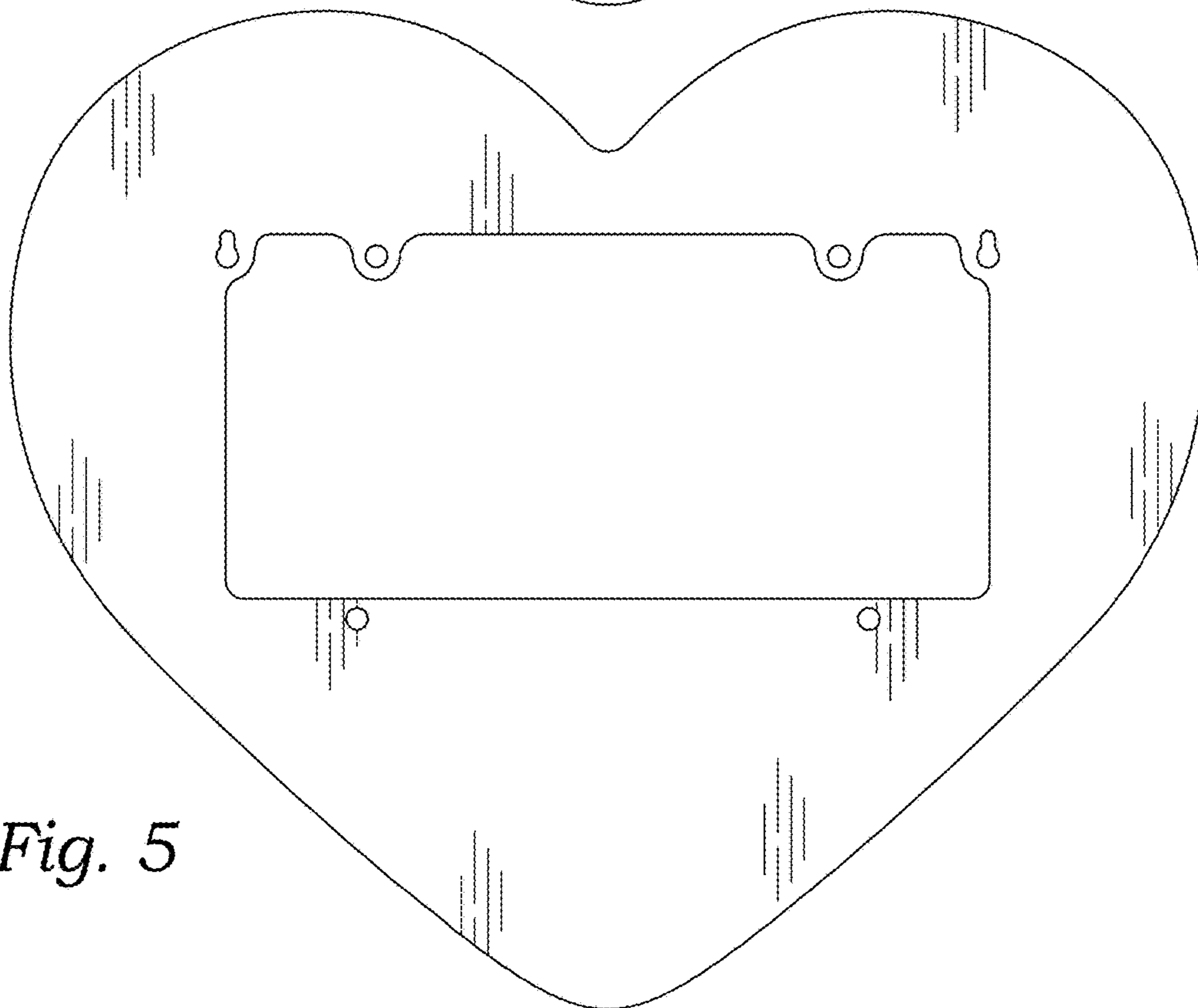

Fig. 5

Fig. 6



Fig. 7

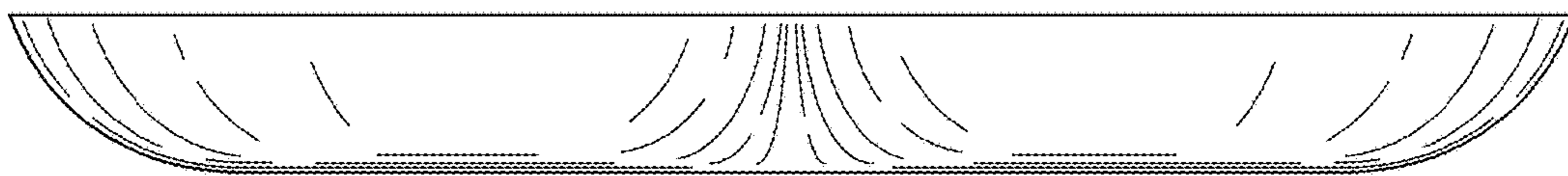

Fig. 8

