



US00D809394S

(12) **United States Design Patent**
Steward et al.

(10) **Patent No.: US D809,394 S**

(45) **Date of Patent: ** Feb. 6, 2018**

(54) **BOTTLE**

(71) Applicant: **The Coca-Cola Company**, Atlanta, GA (US)

(72) Inventors: **Sterling Lane Steward**, Douglasville, GA (US); **Christopher Michael Weston**, London (GB); **Matthew Stuart Garwood**, Cardiff (GB); **Simon Daniel**, London (GB)

(73) Assignee: **THE COCA-COLA COMPANY**, Atlanta, GA (US)

(**) Term: **15 Years**

(21) Appl. No.: **29/565,806**

(22) Filed: **May 24, 2016**

Related U.S. Application Data

(62) Division of application No. 29/466,578, filed on Sep. 9, 2013, now Pat. No. Des. 756,794.

(51) **LOC (11) Cl.** **09-01**

(52) **U.S. Cl.**
USPC **D9/516; D9/538; D9/539**

(58) **Field of Classification Search**
USPC D9/500, 502–505, 516, 520, 530, D9/537–545, 548–550, 556, 558, 652,
(Continued)

(56) **References Cited**

U.S. PATENT DOCUMENTS

D63,657 S 12/1923 Boot
1,635,070 A 7/1927 Clark

(Continued)

Primary Examiner — Dana L Meyrow

(74) *Attorney, Agent, or Firm* — McAndrews, Held & Malloy, Ltd.

(57) **CLAIM**

The ornamental design for a bottle, as shown and described.

DESCRIPTION

FIG. 1 is a perspective view of a first embodiment of a bottle showing our new design;
FIG. 2 is a front elevation view thereof;
FIG. 3 is a rear elevation view thereof;
FIG. 4 is a right-side elevation view thereof;
FIG. 5 is a left-side elevation view thereof;
FIG. 6 is a top plan view thereof;
FIG. 7 is a bottom plan view thereof;
FIG. 8 is a perspective view of a second embodiment of a bottle showing our new design;
FIG. 9 is a front elevation view thereof;
FIG. 10 is a rear elevation view thereof;
FIG. 11 is a right-side elevation view thereof;
FIG. 12 is a left-side elevation view thereof;
FIG. 13 is a top plan view thereof;
FIG. 14 is a bottom plan view thereof;
FIG. 15 is a perspective view of a third embodiment of a bottle showing our new design;
FIG. 16 is a front elevation view thereof;
FIG. 17 is a rear elevation view thereof;
FIG. 18 is a right-side elevation view thereof;
FIG. 19 is a left-side elevation view thereof;
FIG. 20 is a top plan view thereof; and,
FIG. 21 is a bottom plan view thereof.

The dot-dash broken lines in the drawings define the boundaries of the claimed design and form no part thereof. The evenly-dashed broken lines in the drawings illustrate portions of the bottle that form no part of the claimed design. The oblique line shading shown in Embodiments 2 and 3 is used to denote claimed surfaces of the bottle that are transparent; in these embodiments, except for in FIG. 8 and 15, the details of the opposing sides as seen through the claimed transparent surfaces of the bottle have not been shown for ease of illustration and understanding.

1 Claim, 12 Drawing Sheets

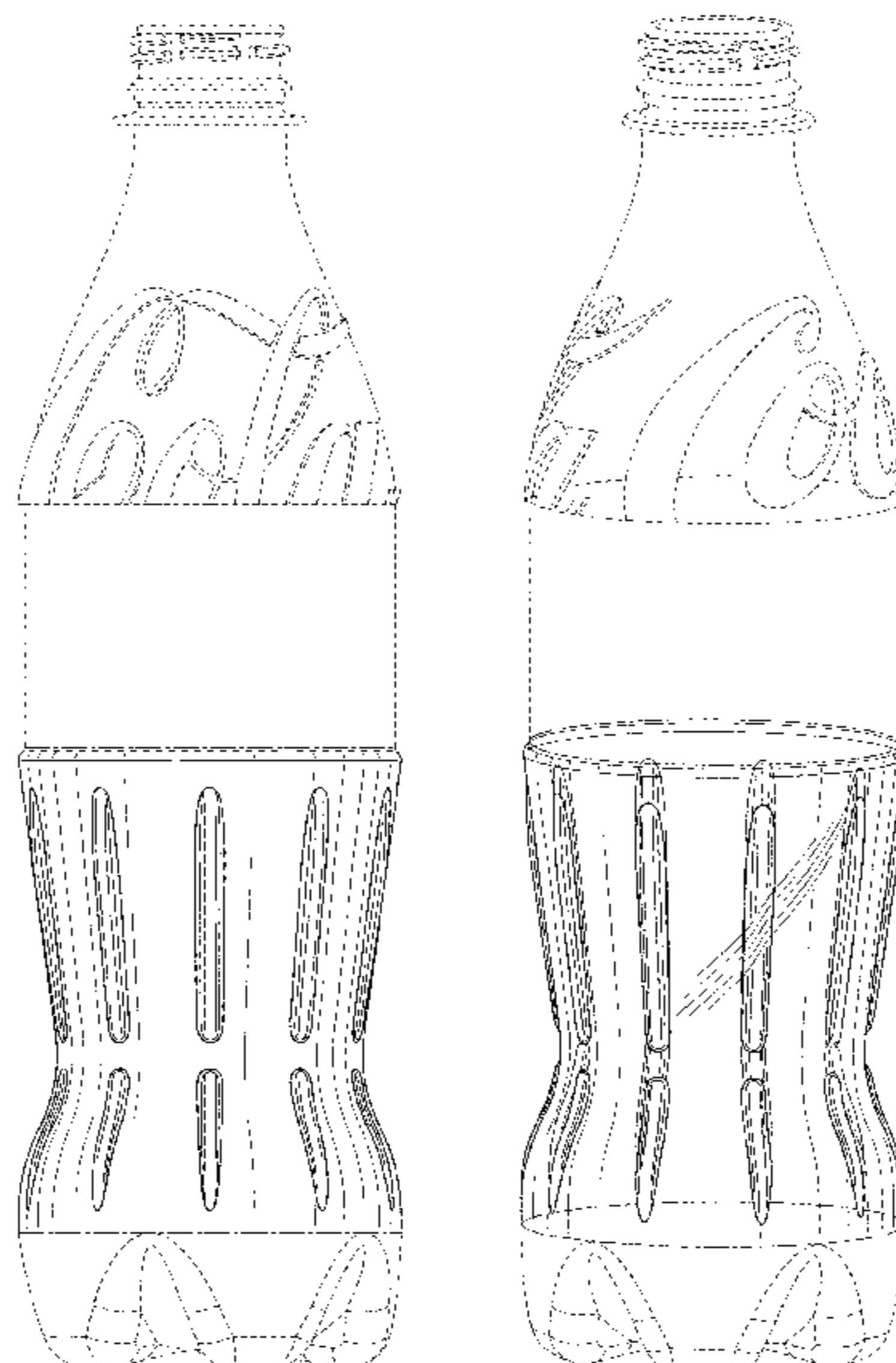

US D809,394 S

Page 2

(58) **Field of Classification Search**

USPC D9/715, 719; 215/370, 371, 375, 379,
215/381-384; 220/660, 669-671,
220/674-675
CPC B65D 1/00; B65D 1/02; B65D 1/0223;
B65D 1/0284; B65D 23/00; B65D
23/001; B65D 83/00; B65D 91/00; B65D
91/02; B65D 2501/00; B65D 2501/0009
See application file for complete search history.

(56) **References Cited**

U.S. PATENT DOCUMENTS

1,891,794 A 12/1932 Bobrick
D105,529 S 8/1937 Kelly
D133,559 S 8/1942 Meyer
D196,389 S 9/1963 Mason
3,871,541 A 3/1975 Adomaitis
D380,671 S * 7/1997 Young D9/538
D383,677 S 9/1997 Darr
5,735,421 A 4/1998 Deemer et al.
5,740,934 A * 4/1998 Brady B65D 1/0223
215/375

5,803,289 A * 9/1998 Brady B65D 1/0207
206/459.5
5,888,598 A * 3/1999 Brewster B29C 49/0005
264/513
D415,030 S * 10/1999 Searle D9/520
6,112,925 A 9/2000 Nahill et al.
6,149,024 A * 11/2000 Deemer B65D 1/0223
215/375
6,467,620 B1 10/2002 Heckman et al.
D504,825 S * 5/2005 Nielson D9/531
D567,663 S 4/2008 Kinmont et al.
D577,291 S 9/2008 Kinmont et al.
D582,290 S 12/2008 Dimmel et al.
D592,455 S 5/2009 Germann
8,186,529 B2 5/2012 Kinmont et al.
D710,206 S 8/2014 Rajesh et al.
D719,033 S 12/2014 Kaddari
D736,627 S * 8/2015 Fleischhacker D9/500
D736,628 S 8/2015 Fleischhacker
D736,629 S * 8/2015 Fleischhacker D9/500
D756,794 S 5/2016 Steward et al.
D760,084 S * 6/2016 Steward D9/537
D792,229 S * 7/2017 Steward D9/500
2008/0257855 A1 10/2008 Patel
2016/0256910 A1 * 9/2016 Niec B21D 26/049

* cited by examiner

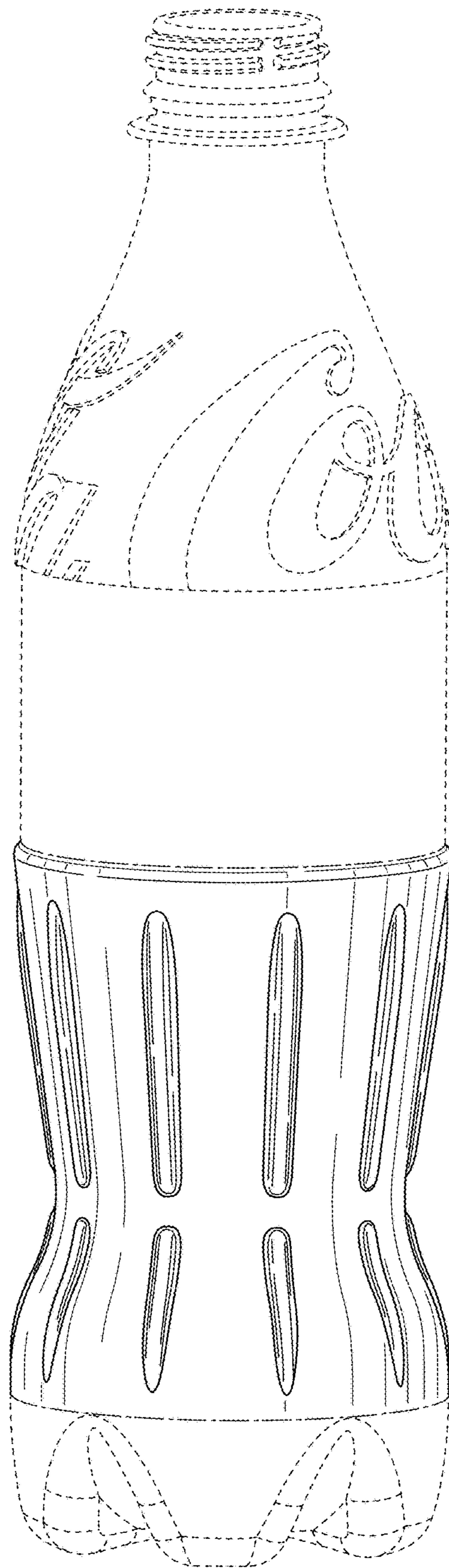

FIG. 1

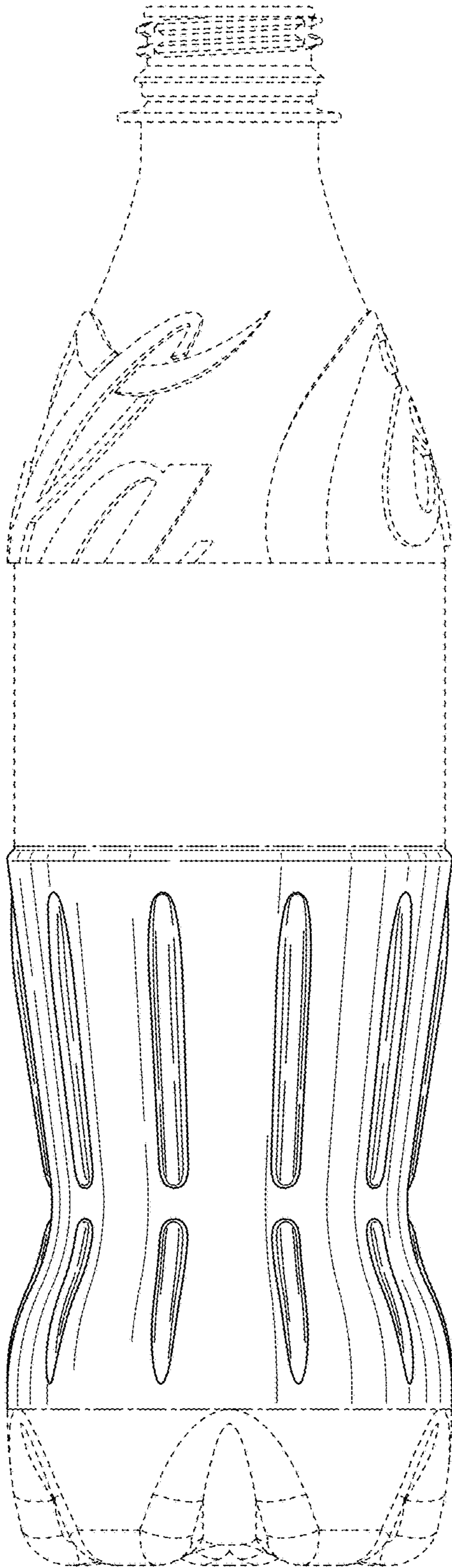

FIG. 2

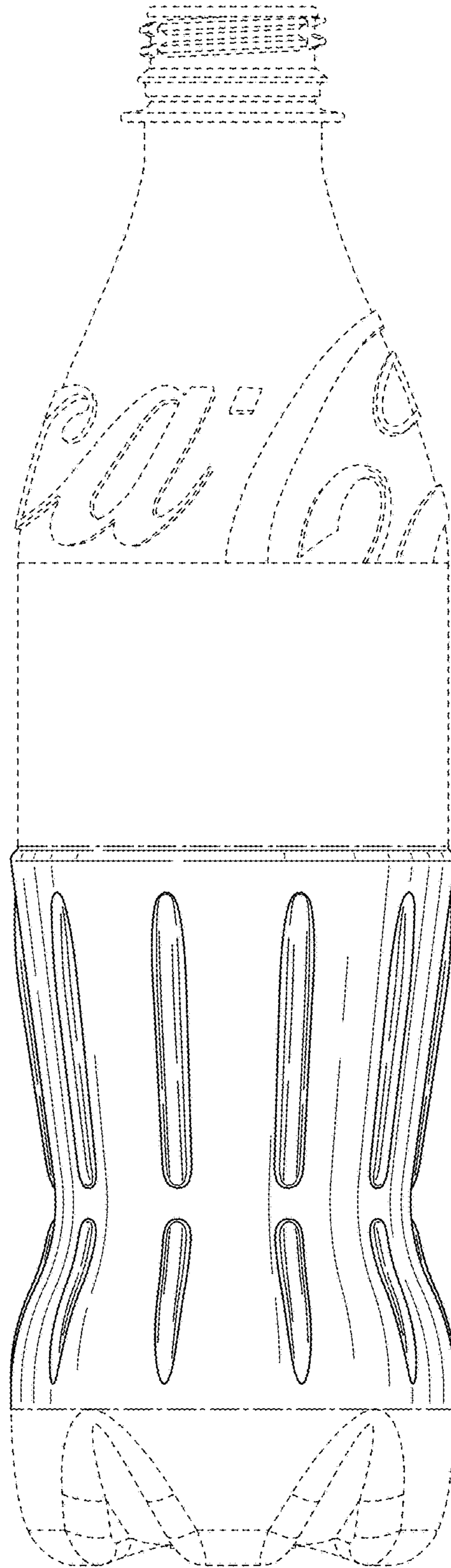

FIG. 3

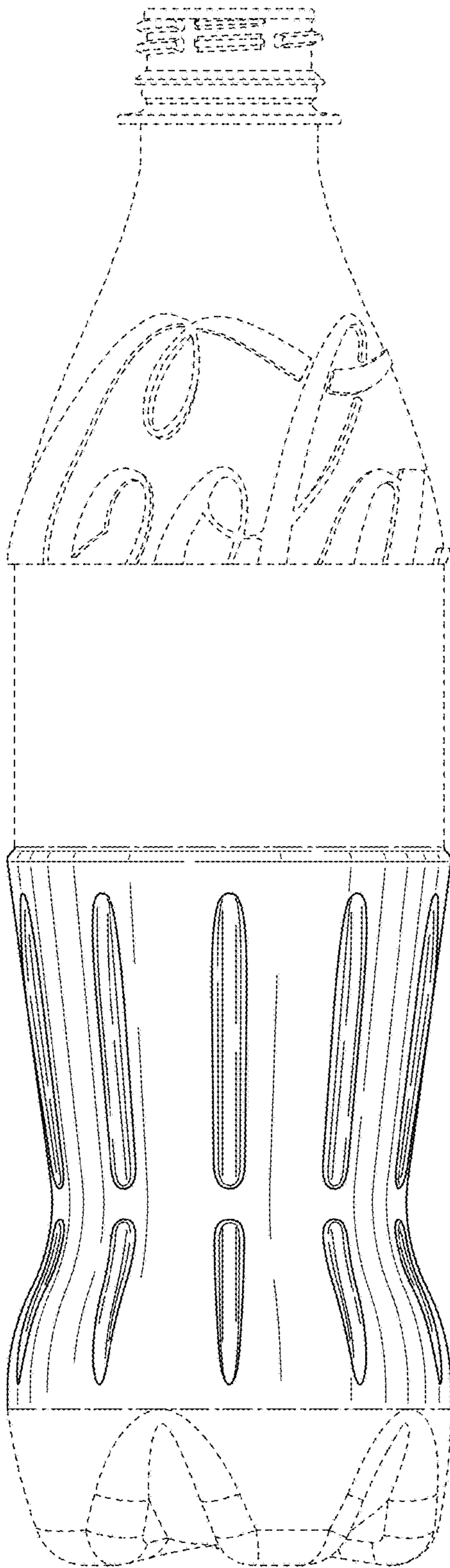

FIG. 4

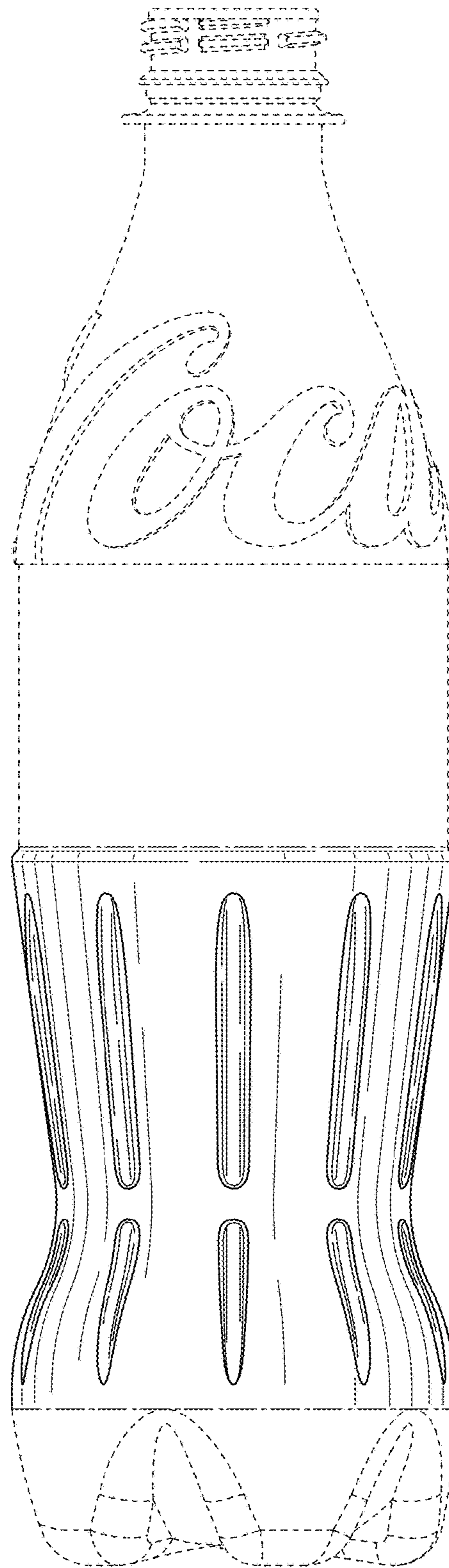

FIG. 5

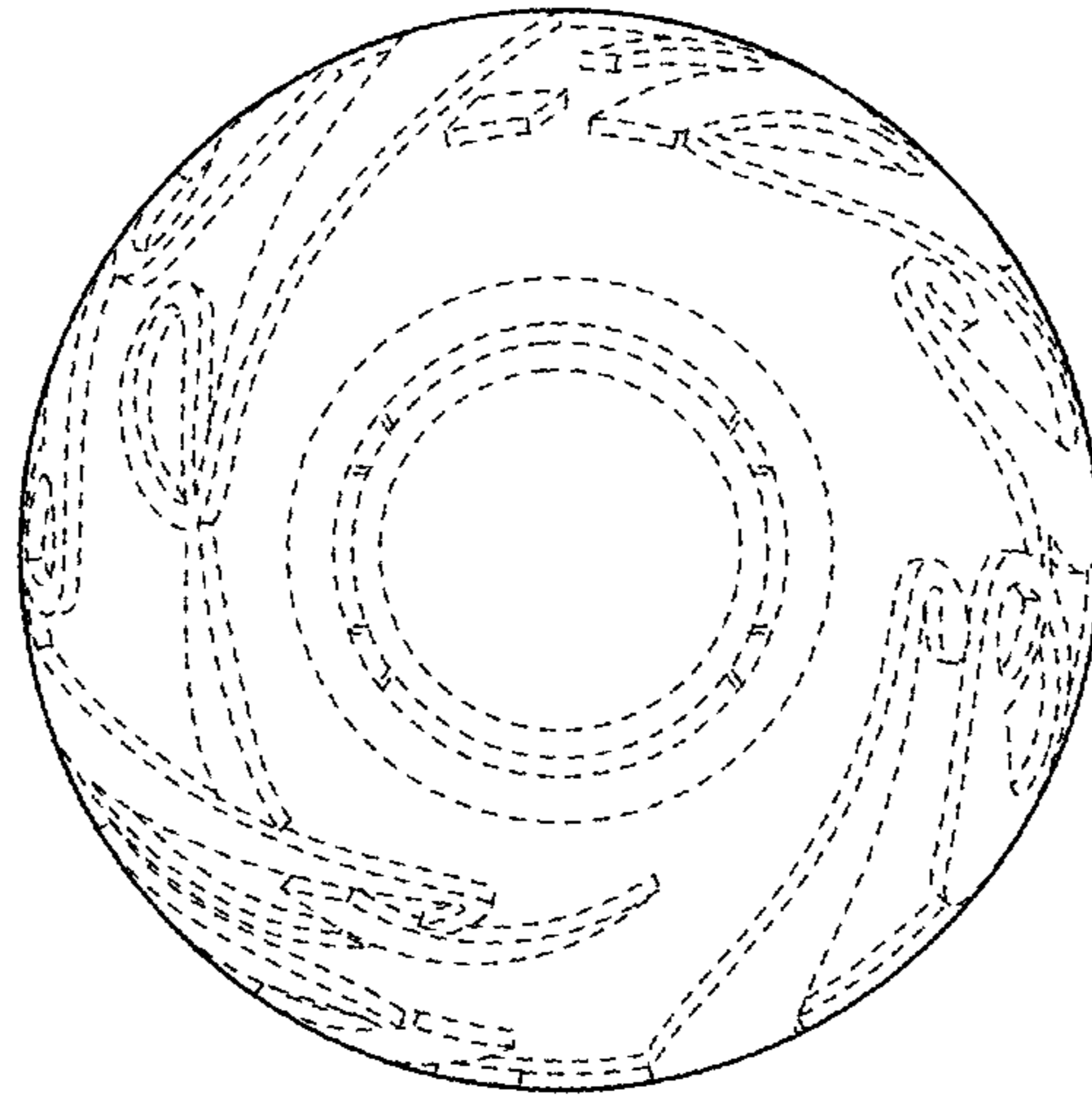

FIG. 6

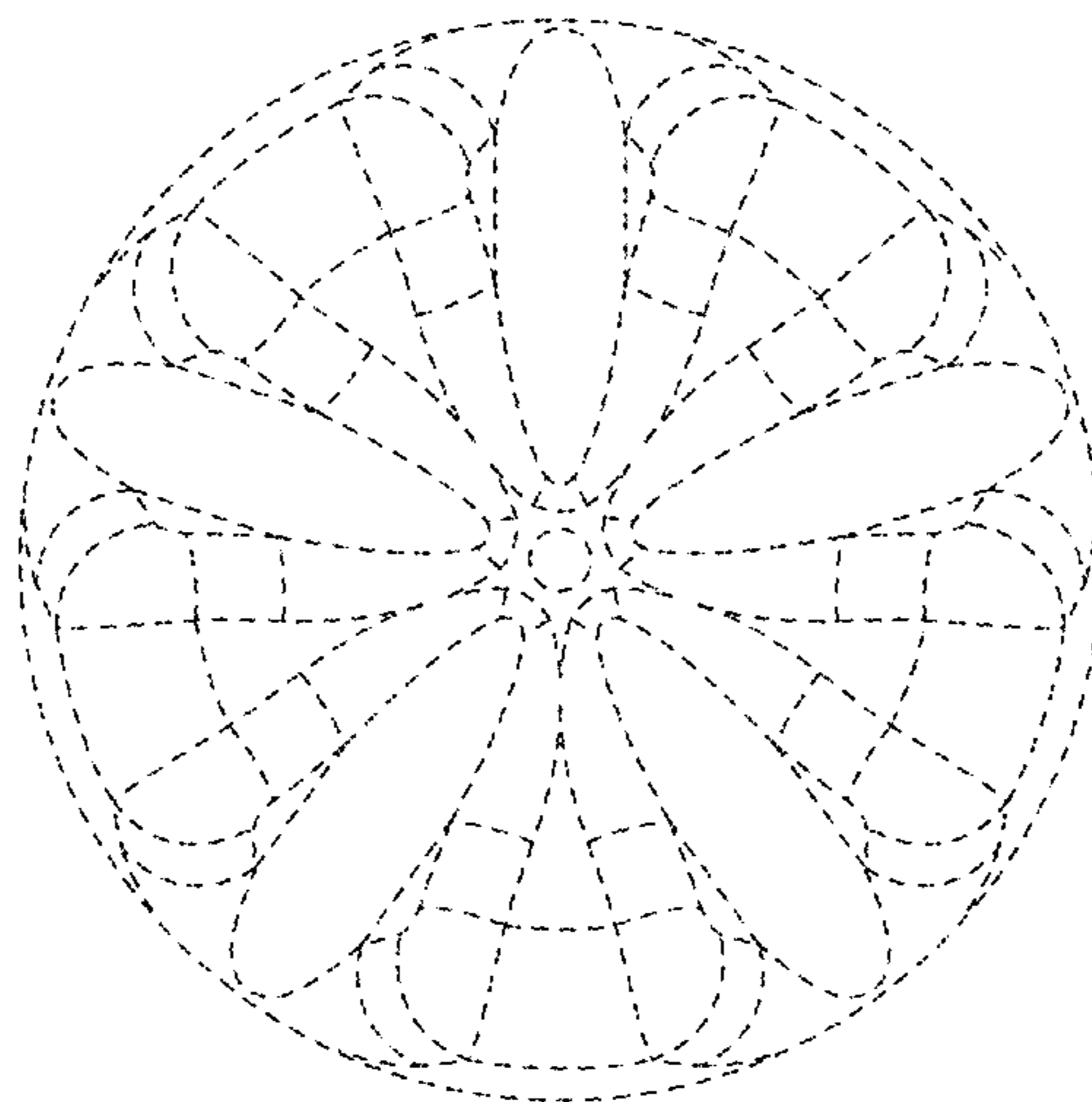

FIG. 7

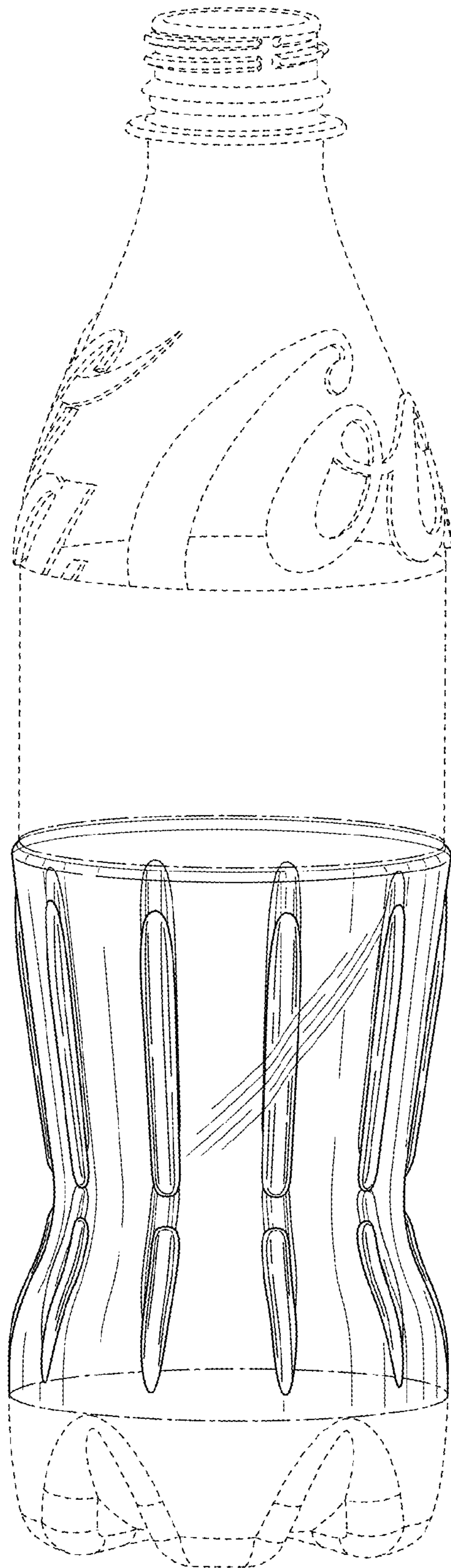

FIG. 8

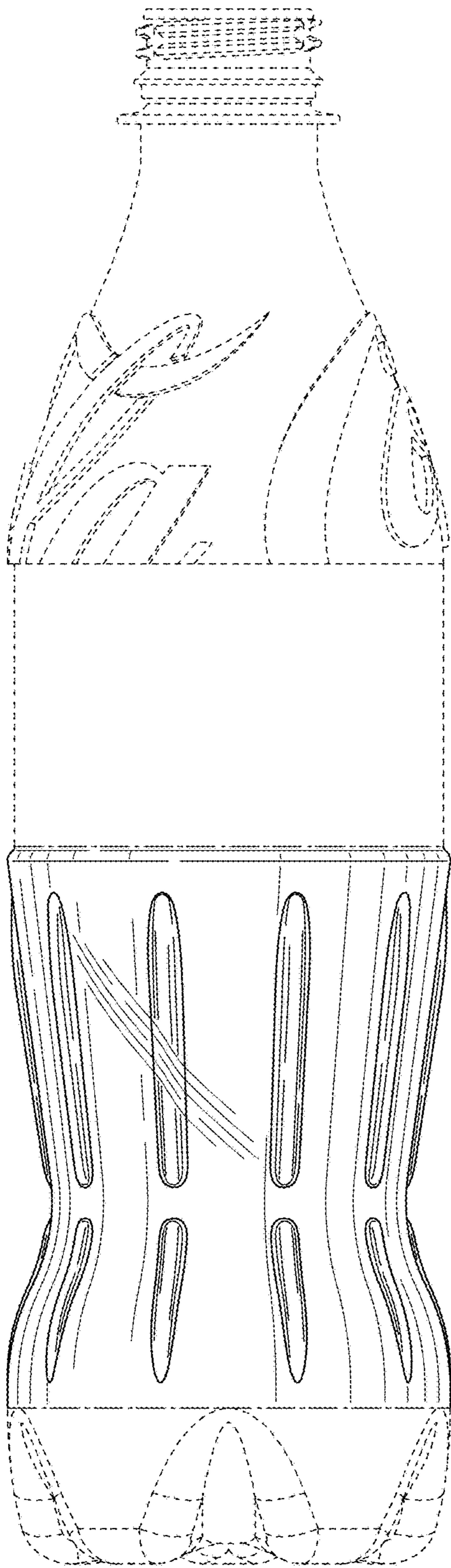

FIG. 9

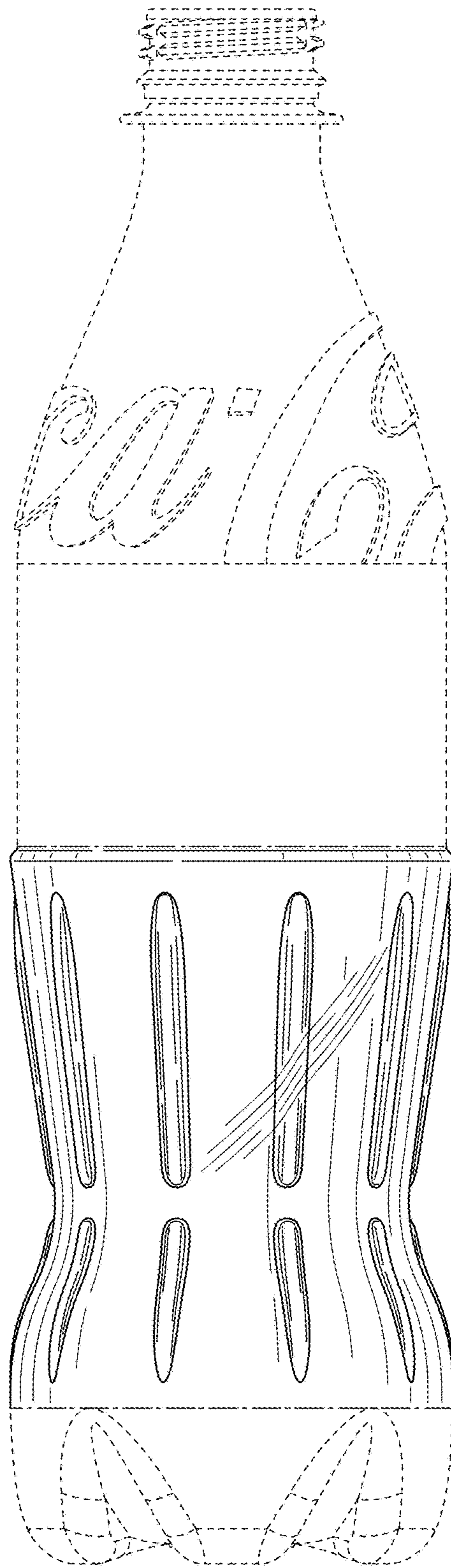

FIG. 10

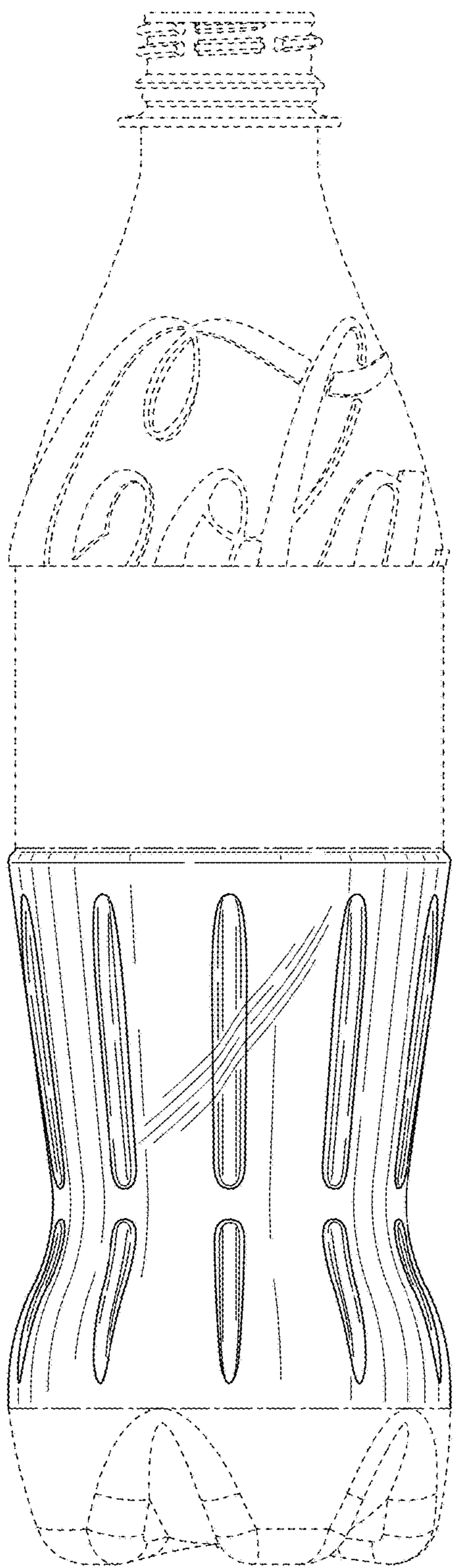

FIG. 11

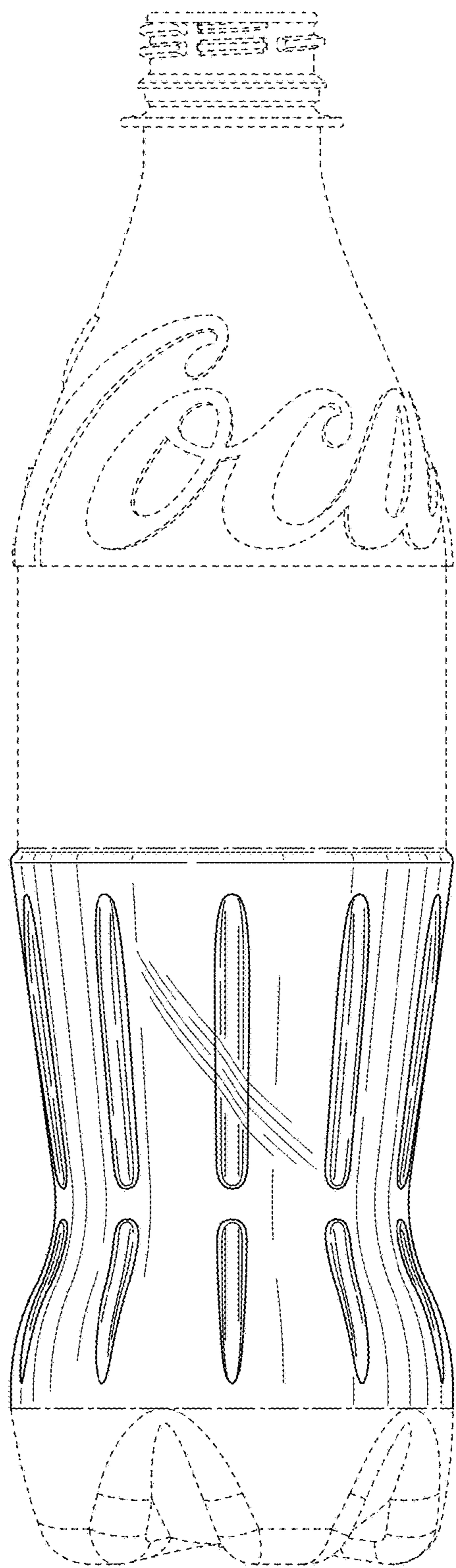

FIG. 12

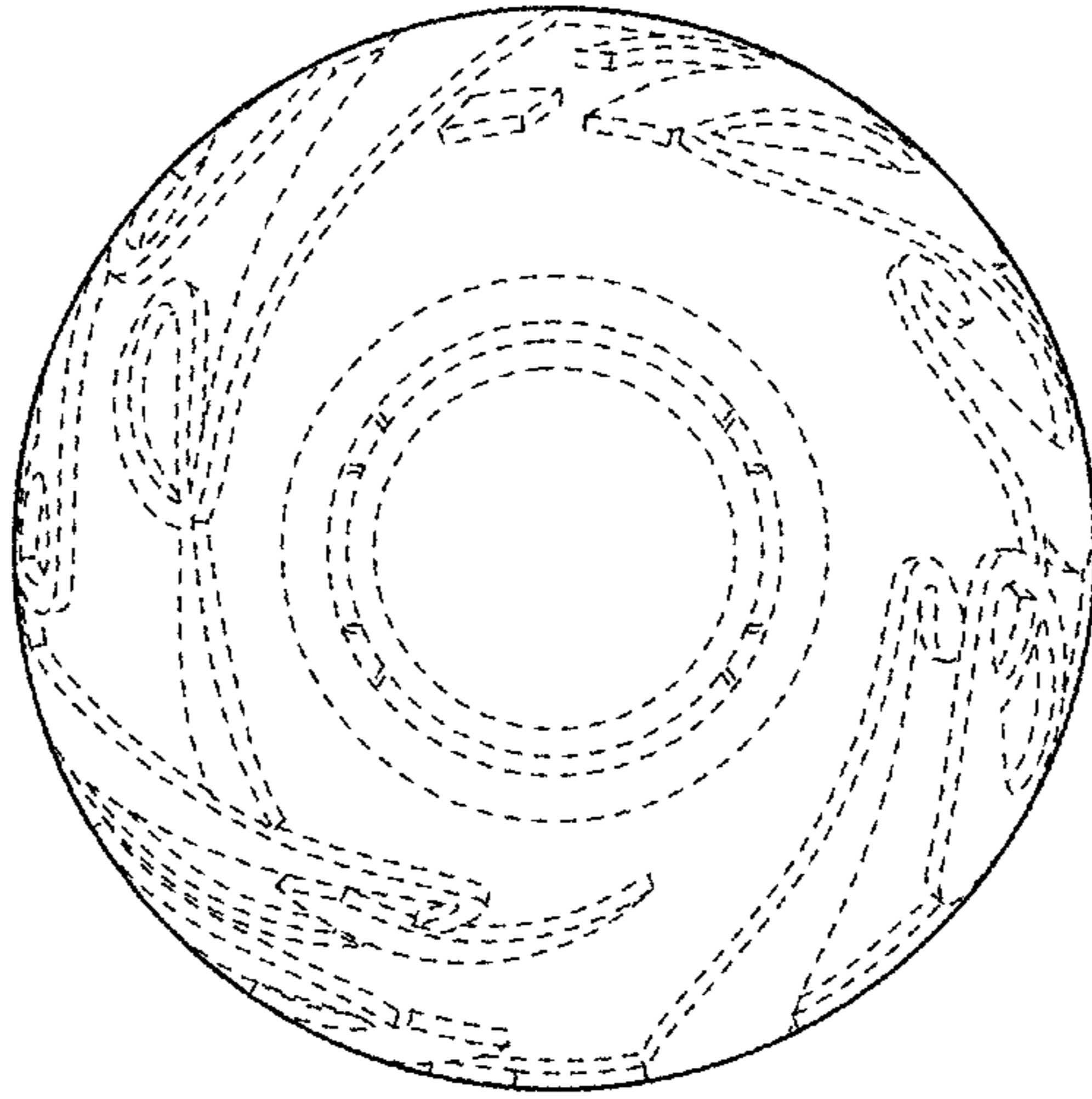

FIG. 13

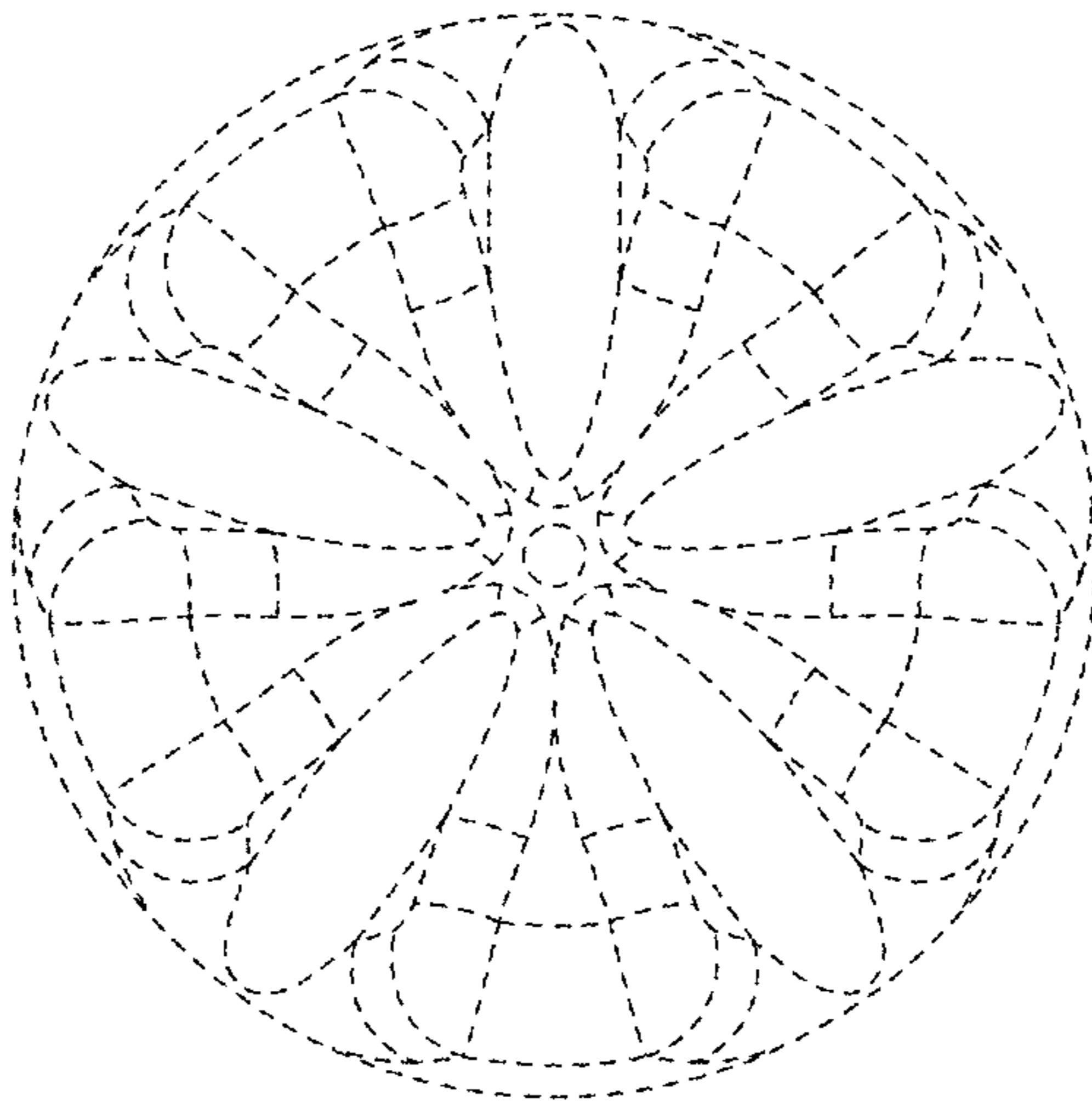

FIG. 14

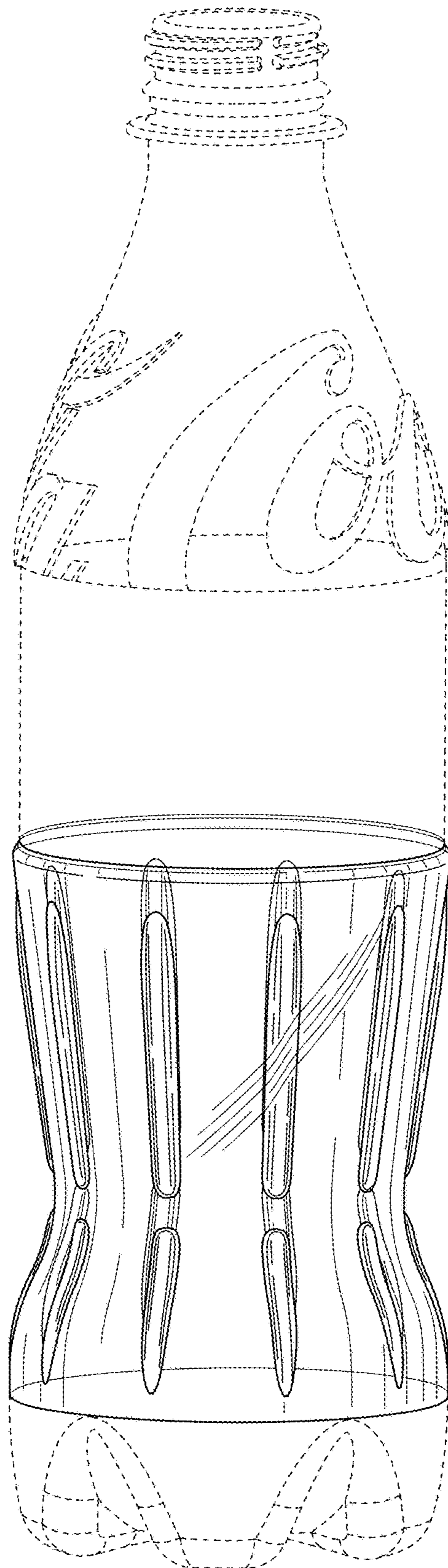

FIG. 15

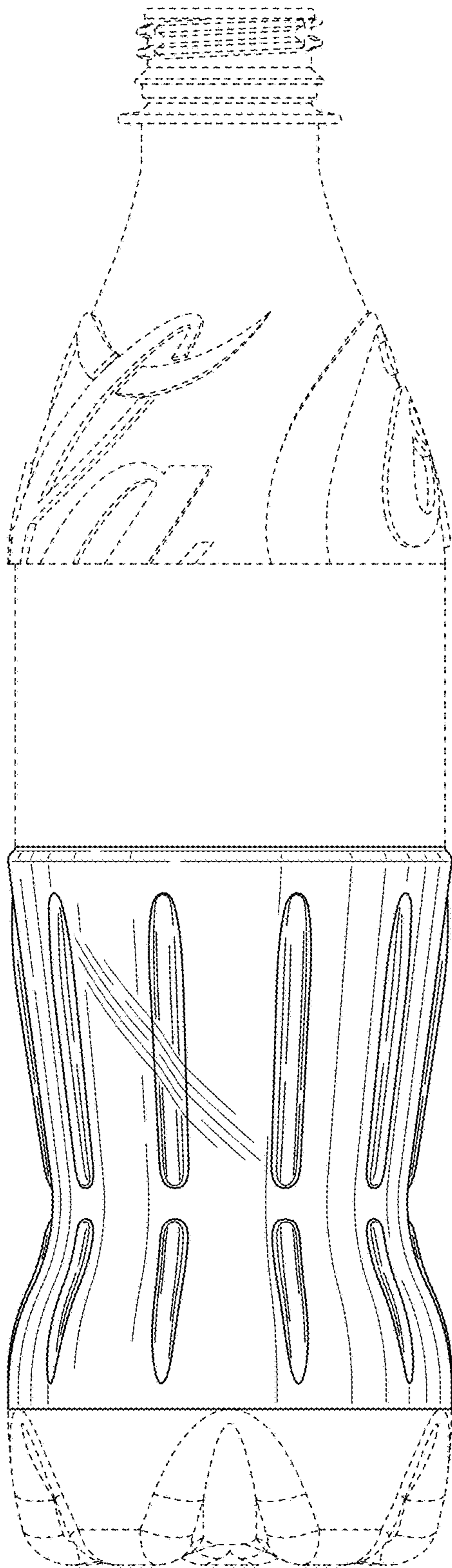

FIG. 16

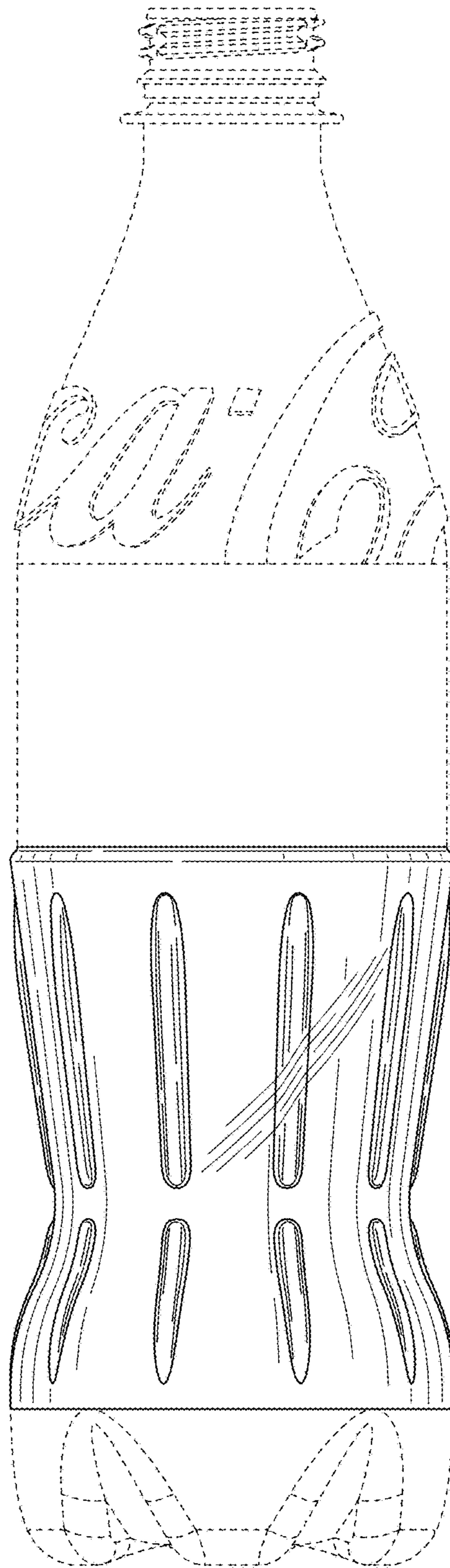

FIG. 17

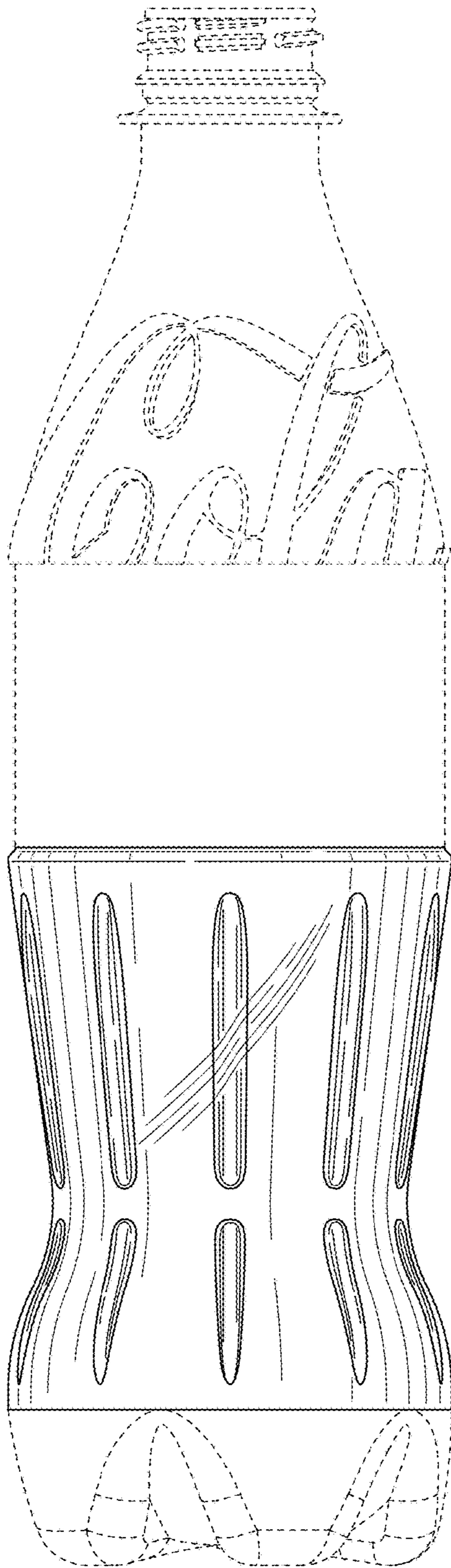

FIG. 18

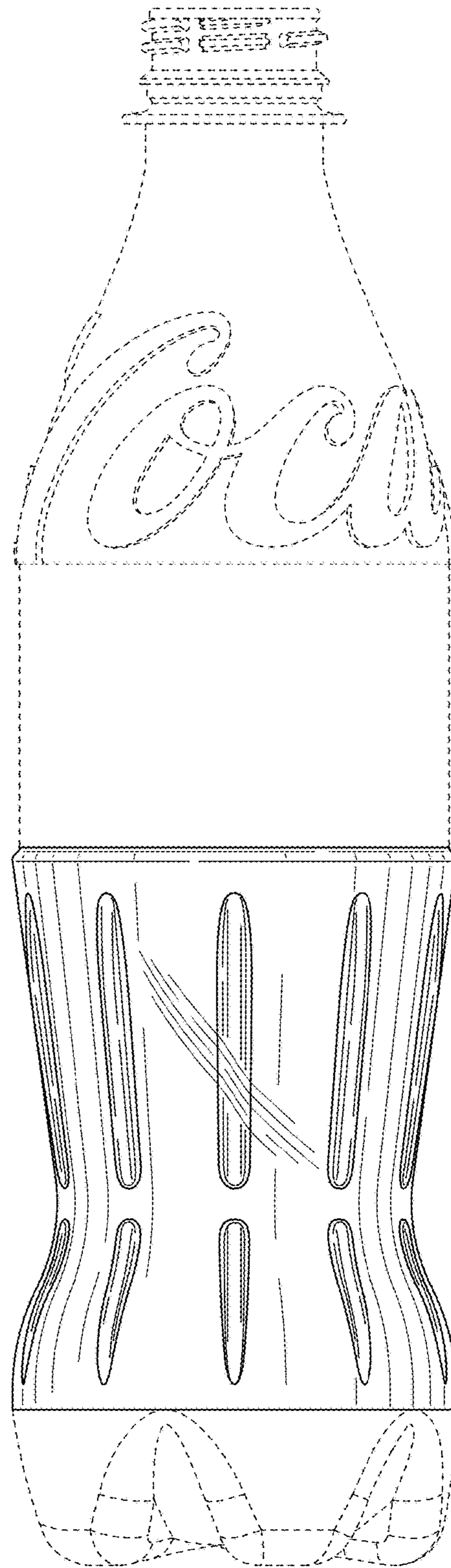

FIG. 19

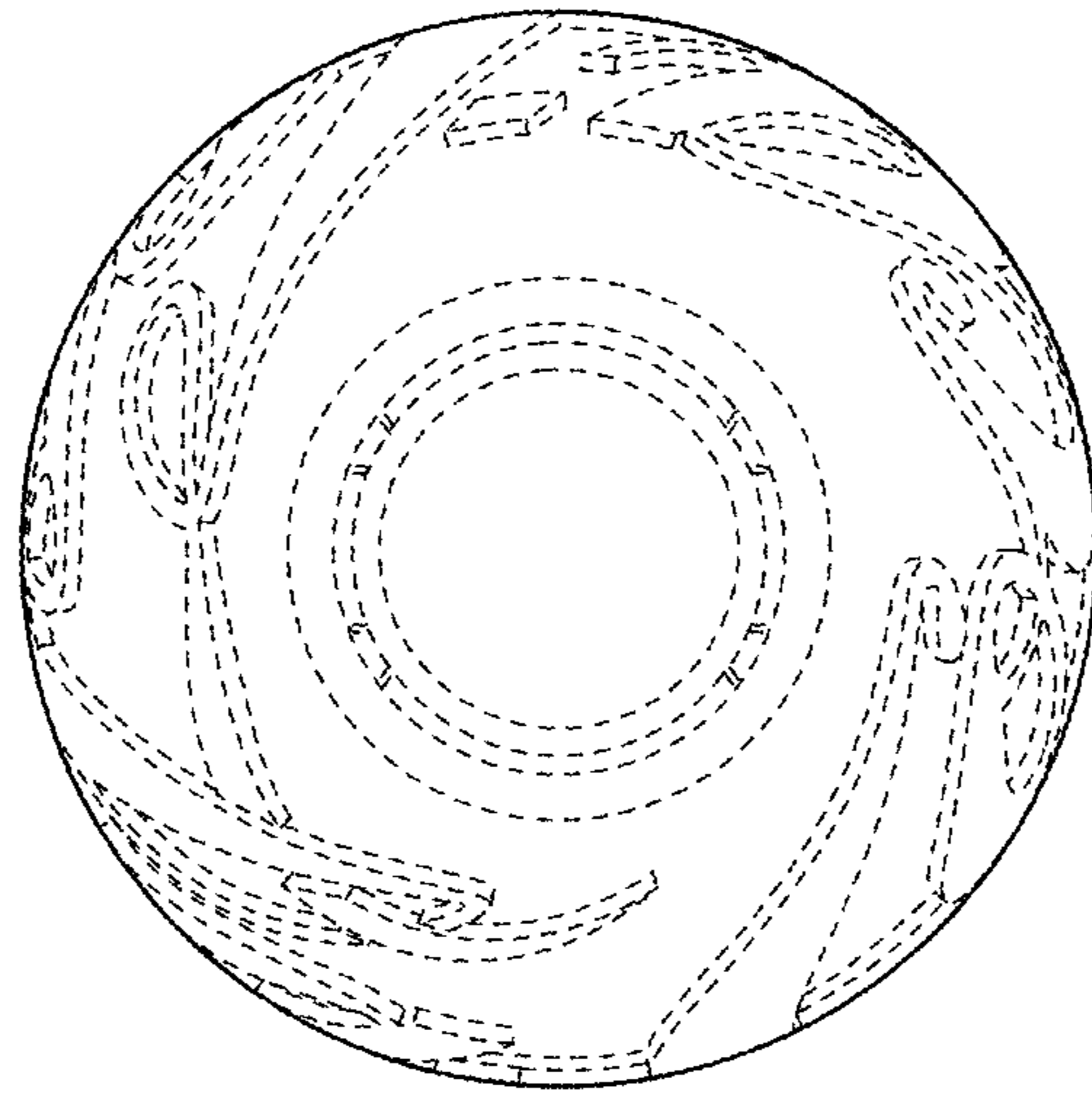

FIG. 20

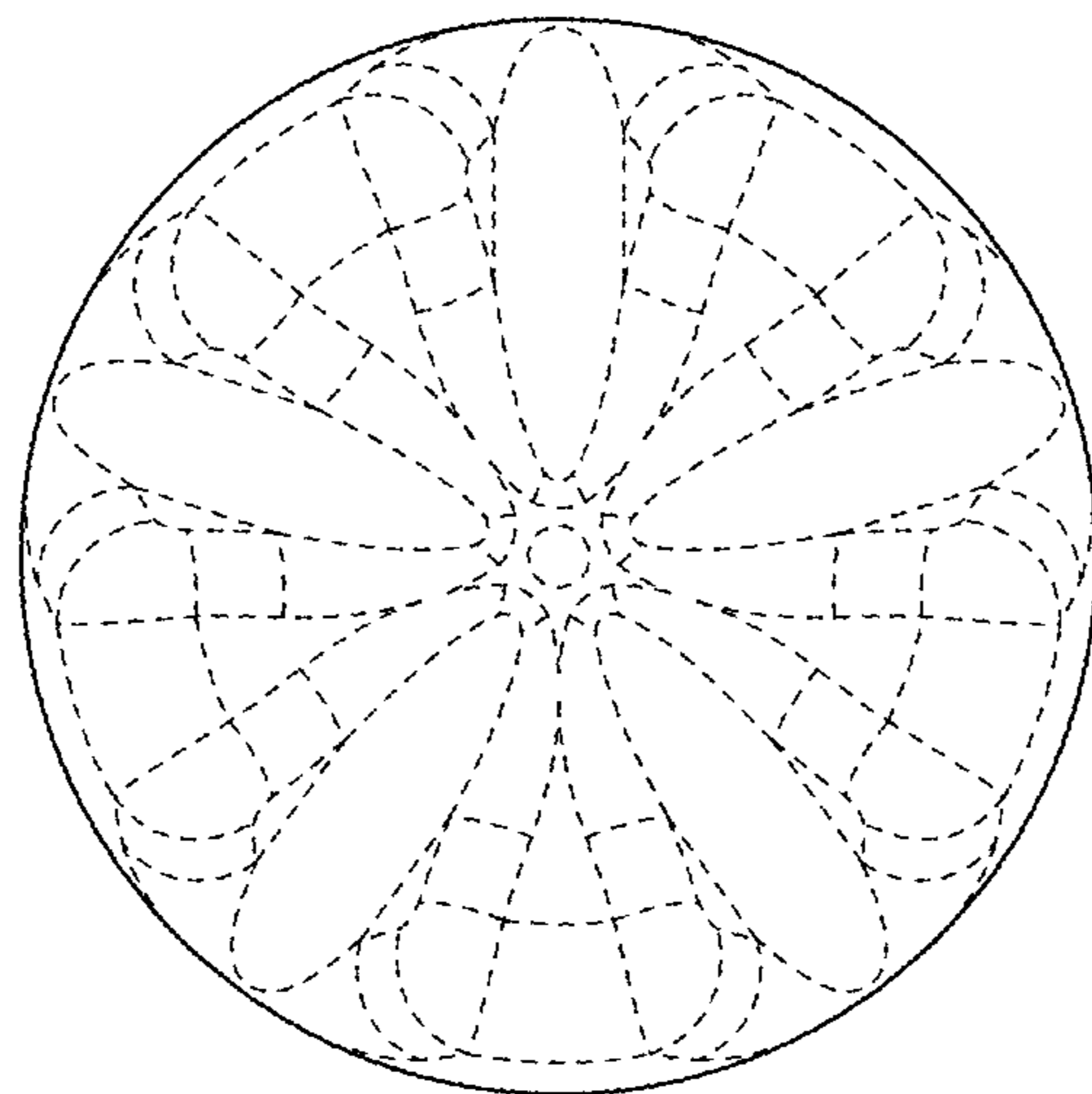

FIG. 21