

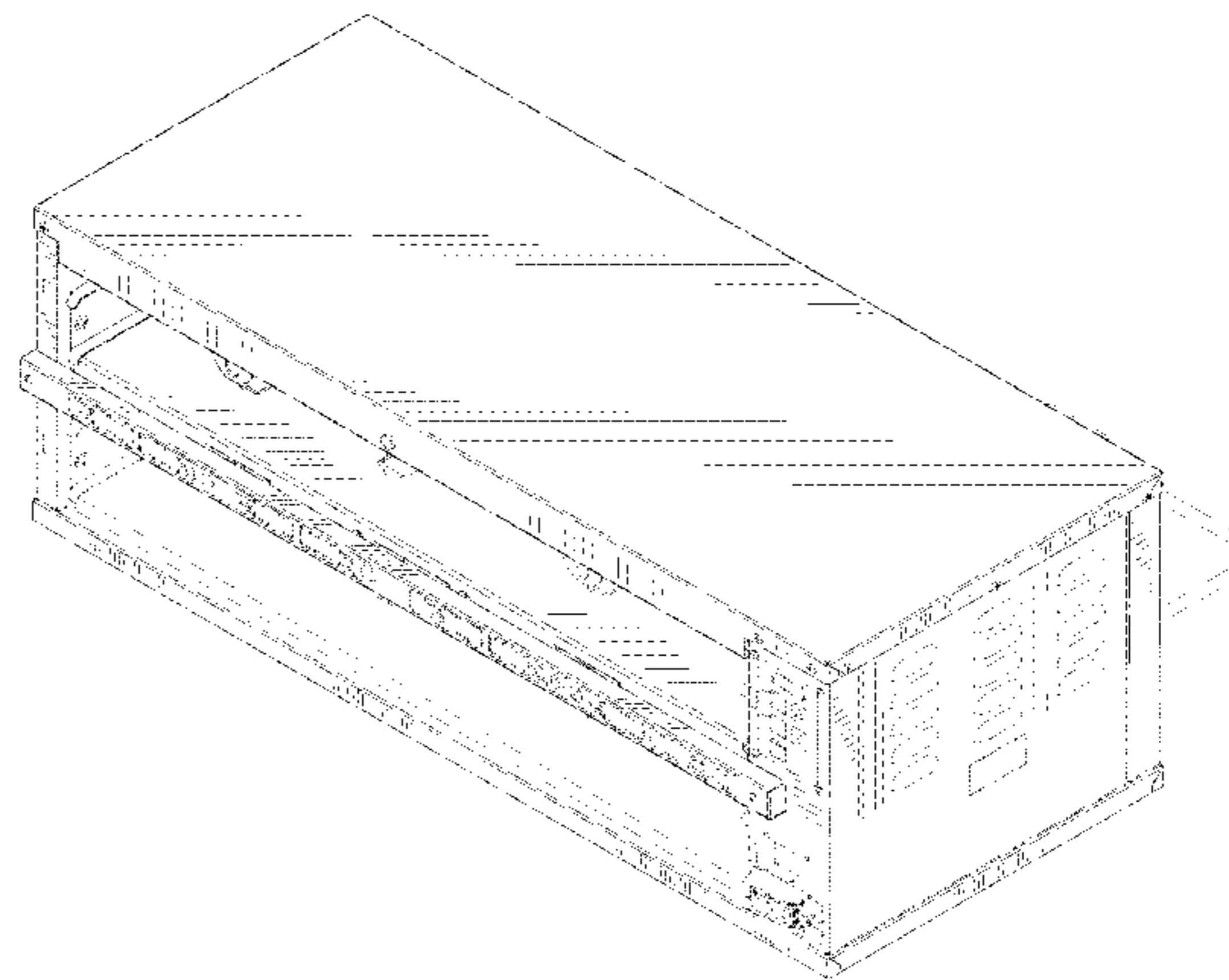

US00D809326S

(12) **United States Design Patent** (10) **Patent No.:** **US D809,326 S**  
**Kestner et al.** (45) **Date of Patent:** **\*\* Feb. 6, 2018**

- (54) **FOOD HOLDING BIN** 3,393,630 A \* 7/1968 Pickens ..... A47J 37/07  
99/340
- (71) Applicant: **PRINCE CASTLE LLC**, Carol Stream, IL (US) 3,414,709 A 12/1968 Tricault  
3,696,720 A 10/1972 Vinson  
3,950,632 A 4/1976 Rivelli  
3,979,056 A 9/1976 Barnes
- (72) Inventors: **Kyle Thomas Kestner**, Schaumburg, IL (US); **Christopher B. Lyons, Jr.**, La Grange, IL (US); **Charles B. Hartfelder**, Hanover Park, IL (US); **Zachary N. McCoy**, South Elgin, IL (US) D243,362 S 2/1977 Shumrak et al.  
4,036,995 A 7/1977 Koether et al.  
4,077,690 A 3/1978 Koether  
4,093,041 A \* 6/1978 Davis ..... A47J 39/006  
126/268
- (73) Assignee: **PRINCE CASTLE LLC**, Carol Stream, IL (US) 4,278,872 A 7/1981 Koether et al.  
4,306,616 A 12/1981 Woods, Jr. et al.  
4,355,521 A 10/1982 Tsai  
4,388,689 A 6/1983 Hayman et al.  
4,530,067 A 7/1985 Dorr  
4,569,421 A 2/1986 Sandstedt  
4,610,238 A 9/1986 Veth  
4,633,230 A 12/1986 Tam  
4,644,931 A 2/1987 Veth  
4,688,475 A 8/1987 Witt et al.  
4,740,888 A 4/1988 Ceste, Sr. et al.  
4,742,455 A 5/1988 Schreyer  
4,782,445 A 11/1988 Pasquini  
4,812,625 A 3/1989 Ceste, Sr.  
4,812,963 A 3/1989 Albrecht et al.  
4,864,498 A 9/1989 Pasquini et al.  
4,911,068 A 3/1990 Koether et al.  
4,922,435 A 5/1990 Cahlander et al.  
5,003,472 A 3/1991 Perrill et al.  
5,069,273 A 12/1991 O'Hearne  
5,093,556 A 3/1992 Oelfke  
5,128,862 A 7/1992 Mueller  
5,132,914 A 7/1992 Cahlander et al.  
5,172,328 A 12/1992 Cahlander et al.  
5,188,020 A 2/1993 Buchnag  
5,216,918 A 6/1993 Landis et al.  
5,218,527 A 6/1993 Ishikawa et al.  
5,247,807 A 9/1993 Jarman et al.  
5,253,564 A 10/1993 Rosenbrock et al.  
D341,054 S 11/1993 Maputol  
5,357,426 A 10/1994 Morita et al.  
D364,530 S 11/1995 Robards, Jr. et al.  
5,485,780 A 1/1996 Koether et al.  
D369,269 S 4/1996 Labadia Del Fresno  
5,504,589 A 4/1996 Montague et al.  
5,510,979 A 4/1996 Moderi et al.  
5,539,671 A 7/1996 Albrecht et al.  
5,553,312 A 9/1996 Gattey et al.  
5,579,952 A 12/1996 Fiedler et al.  
5,590,586 A 1/1997 Ulfig et al.  
5,594,222 A 1/1997 Caldwell  
5,616,269 A 4/1997 Fowler et al.
- (\*\*) Term: **15 Years**
- (21) Appl. No.: **29/561,751**
- (22) Filed: **Apr. 19, 2016**
- (51) **LOC (11) Cl.** ..... **07-02**
- (52) **U.S. Cl.**  
USPC ..... **D7/323; D7/339; D7/347**
- (58) **Field of Classification Search**  
USPC ..... D7/323, 334, 339, 347, 350.3, 352, 354, D7/355, 357  
CPC ..... A47J 37/0623; A47J 37/0605; A47J 37/0709; A47J 39/002; A47J 39/006; A47J 36/2483; A27L 1/00; A23C 3/02; F24C 15/30; F24C 15/16; F24C 15/325; F24C 11/00  
See application file for complete search history.
- (56) **References Cited**  
U.S. PATENT DOCUMENTS  
D63,818 S 1/1924 Curtiss  
2,386,919 A 10/1945 Tobey  
2,900,806 A 8/1959 Wurtz et al.  
2,934,913 A 5/1960 Haines et al.  
3,042,384 A 7/1962 Bauman  
3,275,393 A 9/1966 Stentz et al.  
3,301,618 A 1/1967 Feldser et al.  
3,308,633 A 3/1967 Kritzer, Jr.

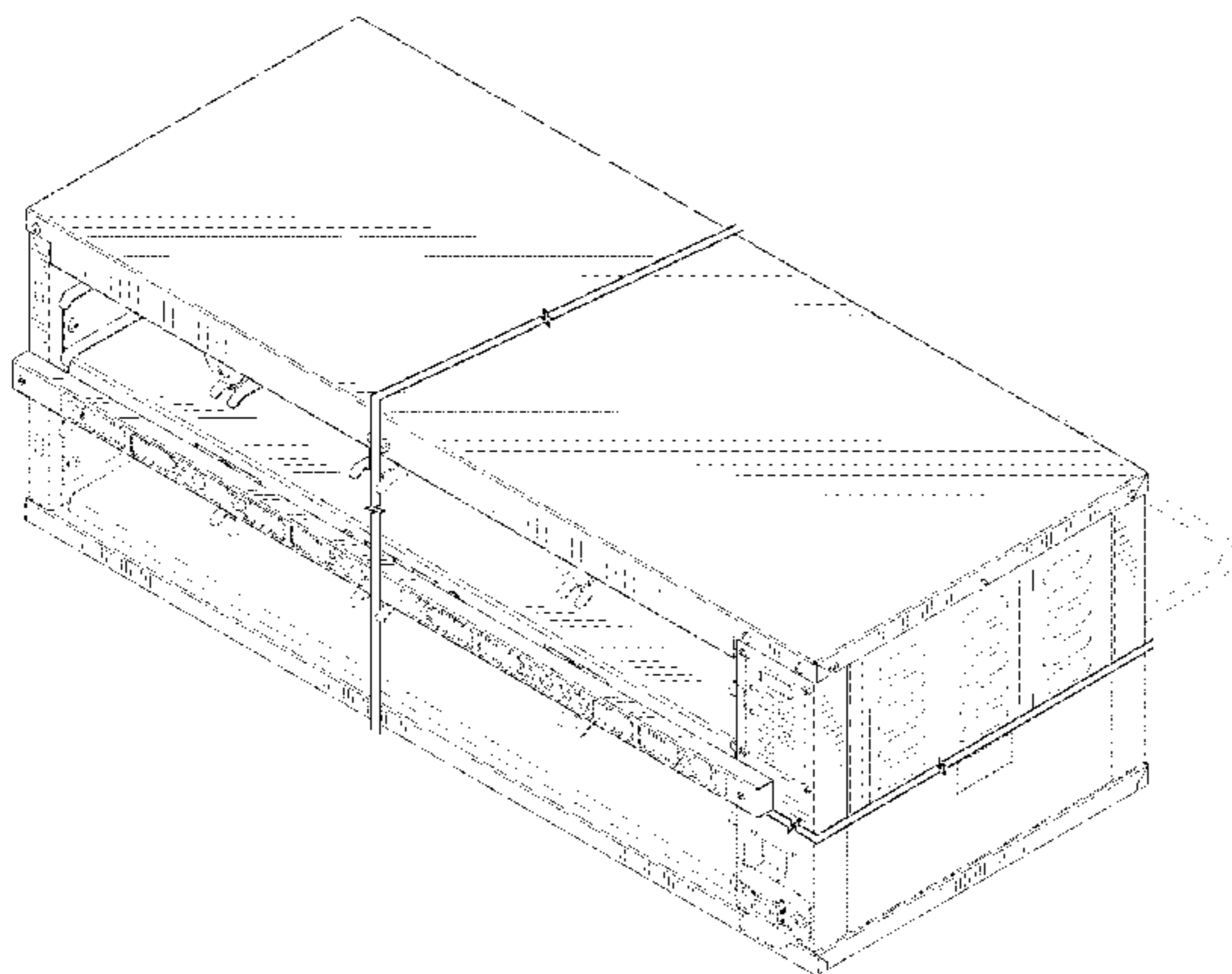

# US D809,326 S

5,653,906 A	8/1997	Fowler et al.	8,997,636 B2 *	4/2015	Kirby ..... A47J 39/006 715/700
5,724,886 A	3/1998	Ewald et al.			
5,772,072 A	6/1998	Prescott et al.	9,003,820 B2	4/2015	Veltrop
5,783,803 A	7/1998	Robards, Jr.	9,068,768 B2 *	6/2015	Veltrop ..... F25D 25/028
5,812,393 A	9/1998	Drucker	9,140,484 B2 *	9/2015	Veltrop ..... F25D 25/028
5,900,173 A	5/1999	Robards, Jr.	9,140,485 B2 *	9/2015	Veltrop ..... F25D 25/028
5,921,096 A	7/1999	Warren	2001/0007322 A1	7/2001	Shei et al.
5,931,083 A	8/1999	Stanger et al.	2001/0053963 A1	12/2001	Kim et al.
5,939,974 A	8/1999	Heagle et al.	2003/0118706 A1	6/2003	Veltrop
5,944,324 A	8/1999	Schultheis et al.	2004/0000162 A1	1/2004	Song
5,947,012 A	9/1999	Ewald et al.	2004/0016242 A1	1/2004	Song et al.
6,000,622 A	12/1999	Tonner et al.	2004/0019534 A1	1/2004	Callahan et al.
6,006,996 A	12/1999	Bhatnagar	2004/0020915 A1	2/2004	Shei
6,011,243 A	1/2000	Arnold et al.	2004/0060320 A1	4/2004	Roh et al.
6,026,372 A	2/2000	Savage	2005/0211696 A1	9/2005	Adamski
6,031,208 A	2/2000	Witt et al.	2005/0236947 A1	10/2005	LeClear et al.
6,052,667 A	4/2000	Walker et al.	2006/0150662 A1	7/2006	Lee et al.
D427,008 S	6/2000	Wasner	2006/0185527 A1 *	8/2006	Shei ..... A47J 39/006 99/467
D427,479 S	7/2000	Wasner			
6,088,681 A	7/2000	Coleman et al.			
6,114,659 A	9/2000	Finck et al.	2007/0017245 A1	1/2007	Song et al.
6,116,154 A	9/2000	Vaseloff	2007/0144202 A1	6/2007	Theodos et al.
6,119,587 A	9/2000	Ewald et al.	2007/0251397 A1	11/2007	Dorsten et al.
D434,265 S	11/2000	Tatlow	2008/0023462 A1	1/2008	Shei et al.
6,153,244 A	11/2000	Stanger et al.	2008/0213449 A1	9/2008	Wisner et al.
6,158,885 A	12/2000	Landis	2008/0302778 A1	12/2008	Veltrop et al.
6,175,099 B1	1/2001	Shei et al.	2009/0045185 A1	2/2009	Schroeder et al.
6,200,944 B1	3/2001	Dovey et al.	2009/0126580 A1 *	5/2009	Hartfelder ..... A47J 39/006 99/483
6,209,447 B1	4/2001	Ewald et al.			
6,257,010 B1	7/2001	Shei et al.			
6,261,621 B1	7/2001	Stanger et al.	2009/0199723 A1 *	8/2009	Veltrop ..... A47J 37/0623 99/427
6,262,394 B1	7/2001	Shei et al.			
6,412,403 B1	7/2002	Veltrop	2009/0199725 A1 *	8/2009	Veltrop ..... A47J 37/0623 99/483
6,434,961 B2	8/2002	Richmond et al.			
6,502,411 B2	1/2003	Okamoto	2009/0266244 A1	10/2009	Maciejewski et al.
6,541,739 B2	4/2003	Shei et al.	2009/0309027 A1	12/2009	Von Striver
D480,260 S *	10/2003	Domi ..... D7/339	2010/0205992 A1	8/2010	Morris
6,637,322 B2	10/2003	Veltrop	2011/0030565 A1	2/2011	Shei
6,658,994 B1	12/2003	McMillan	2011/0252813 A1 *	10/2011	Veltrop ..... A47J 36/2483 62/3.3
6,825,447 B2	11/2004	Kim et al.			
6,834,276 B1	12/2004	Jensen et al.			
6,878,391 B2	4/2005	Veltrop	2011/0253698 A1	10/2011	Theodos et al.
6,884,451 B2	4/2005	Veltrop	2011/0253703 A1	10/2011	Theodos et al.
7,028,498 B2	4/2006	Monroe et al.	2011/0278278 A1 *	11/2011	Emerich ..... A47J 39/006 219/400
7,105,779 B2	9/2006	Shei			
7,132,926 B2	11/2006	Vaseloff et al.	2011/0283895 A1 *	11/2011	Veltrop ..... A23L 3/005 99/451
7,227,102 B2	6/2007	Shei			
7,235,762 B2	6/2007	Gagas et al.			
7,238,654 B2	7/2007	Hodge et al.	2012/0079699 A1	4/2012	Veltrop et al.
7,258,064 B2	8/2007	Vaseloff et al.	2012/0261426 A1 *	10/2012	Tomczyk ..... A47J 39/02 220/592.01
7,279,659 B2	10/2007	Gagas et al.			
7,328,654 B2	2/2008	Shei	2012/0285942 A1	11/2012	Godecker et al.
RE40,151 E	3/2008	Shei et al.	2013/0175253 A1	7/2013	Shei et al.
RE40,290 E	5/2008	Shei et al.	2014/0010937 A1 *	1/2014	Stanger ..... A47J 39/003 426/520
7,376,485 B2	5/2008	Salerno			
D570,715 S	6/2008	Di Federico	2014/0057031 A1 *	2/2014	Ewald ..... A47F 10/06 426/418
7,381,927 B1	6/2008	Agnello			
7,385,160 B2	6/2008	Jones	2014/0083309 A1 *	3/2014	Reese ..... A47J 39/003 99/474
7,446,282 B2	11/2008	Shei et al.			
7,628,107 B2	12/2009	Vaseloff et al.			
7,762,636 B2	7/2010	Veaser et al.	2014/0130684 A1	5/2014	Reese et al.
7,858,906 B2	12/2010	Veltrop et al.	2014/0150461 A1	6/2014	Veltrop
7,905,173 B2	3/2011	Sus et al.	2014/0165644 A1	6/2014	Veltrop
7,971,523 B2 *	7/2011	Hartfelder ..... A47J 39/006 426/418	2014/0174101 A1	6/2014	Veltrop
			2014/0197177 A1	7/2014	Veltrop et al.
8,091,472 B2	1/2012	Maciejewski et al.	2014/0246966 A1 *	9/2014	Nevarez ..... A47J 39/02 312/236
8,096,231 B2	1/2012	Veltrop et al.			
8,134,101 B2 *	3/2012	Majchrzak ..... A47J 39/003 126/21 A			
			2014/0263269 A1	9/2014	Veltrop et al.
8,247,745 B2	8/2012	Chung et al.	2015/0201749 A1 *	7/2015	Turner ..... A47B 31/02 62/3.61
8,404,292 B2 *	3/2013	Veltrop ..... A47J 37/0623 219/385			
			2015/0201803 A1 *	7/2015	Veltrop ..... A47J 36/2483 62/3.2
8,522,675 B2	9/2013	Veltrop			
8,558,142 B2 *	10/2013	Theodos ..... A47J 39/006 165/121			
8,667,807 B2 *	3/2014	Veltrop ..... A47F 3/06 62/208			
D704,982 S *	5/2014	Gates ..... D7/332	JP		8000414 1/1996
D716,095 S *	10/2014	Veltrop ..... D7/323	JP		10079088 3/1998
			JP		11342061 12/1999

FOREIGN PATENT DOCUMENTS

WO WO-01/31533 A1 5/2001  
 WO WO-2005/034633 A1 4/2005

OTHER PUBLICATIONS

“Modular Holding Cabinets”, Product Catalog, Carter-Hoffmann, Mundelein, Illinois (Jan. 2014).  
 Betzold et al., U.S. Appl. No. 14/278,549, “Modular Food Holding Cabinet Having Individually Configurable Food Holding Units”, filed May 15, 2014.  
 Final Office Action issued for U.S. Appl. No. 12/782,843 dated Dec. 31, 2012, USPTO.  
 Final Office Action issued for U.S. Appl. No. 13/567,821 dated Jun. 6, 2013, USPTO.  
 Frymaster HCP Installation and Operation Manual, Dec. 2006, pp. 1-1 to 10-4, title page and table of publisher, Enodis, Frymaster LLC, Shreveport, LA.  
 Non-Final Office Action issued for U.S. Appl. No. 12/782,843 dated Jun. 19, 2013, USPTO.  
 Non-Final Office Action issued for U.S. Appl. No. 12/782,843 dated Aug. 21, 2012, USPTO.  
 Non-Final Office Action issued for U.S. Appl. No. 13/567,821 dated Feb. 8, 2013, USPTO.  
 Prince Castle LLC, Holding Bins ([www.princecastle.com](http://www.princecastle.com) <<http://www.princecastle.com>>) (2009).  
 Prince Castle LLC, Holding Panels ([www.princecastle.com](http://www.princecastle.com) <<http://www.princecastle.com>>).  
 Reider, “How to Say What Stuff Looks Like”, Ontario, Canada: Marcus Books, p. 62 (1995).  
 Thermodyne Food Products, Inc., Counter Top Holding Oven Model 300 NDNL specification.  
 Veltrop et al., Design U.S. Appl. No. 29/450,074, “Food Warmer”, filed Mar. 15, 2013.  
 Veltrop et al., Design U.S. Appl. No. 29/494,683, “Food Warmer”, filed Jun. 23, 2014.

\* cited by examiner

*Primary Examiner* — Mary Ann Calabrese  
*Assistant Examiner* — Mehri Bajoul  
 (74) *Attorney, Agent, or Firm* — Marshall, Gerstein & Borun LLP

(57) **CLAIM**

The ornamental design for a food holding bin, as illustrated and described.

**DESCRIPTION**

FIG. 1 is a perspective view of a first embodiment of a food holding bin showing our new design.  
 FIG. 2 is an elevational view of a front side thereof.  
 FIG. 3 is an elevational view of a rear side thereof.  
 FIG. 4 is a top plan view thereof.  
 FIG. 5 is a bottom plan view thereof.  
 FIG. 6 is an elevational view of a right side thereof.  
 FIG. 7 is an elevational view of a left side thereof.  
 FIG. 8 is a perspective view of a second embodiment of a food holding bin showing our new design.  
 FIG. 9 is an elevational view of a front side thereof.  
 FIG. 10 is an elevational view of a rear side thereof.  
 FIG. 11 is a top plan view thereof.  
 FIG. 12 is a bottom plan view thereof.  
 FIG. 13 is an elevational view of a right side thereof.  
 FIG. 14 is an elevational view of a left side thereof.

FIG. 15 is a perspective view of a third embodiment of a food holding bin showing our new design.  
 FIG. 16 is an elevational view of a front side thereof.  
 FIG. 17 is an elevational view of a rear side thereof.  
 FIG. 18 is a top plan view thereof.  
 FIG. 19 is a bottom plan view thereof.  
 FIG. 20 is an elevational view of a right side thereof.  
 FIG. 21 is an elevational view of a left side thereof.  
 FIG. 22 is a perspective view of a fourth embodiment of a food holding bin showing our new design.  
 FIG. 23 is an elevational view of a front side thereof.  
 FIG. 24 is an elevational view of a rear side thereof.  
 FIG. 25 is a top plan view thereof.  
 FIG. 26 is a bottom plan view thereof.  
 FIG. 27 is an elevational view of a right side thereof.  
 FIG. 28 is an elevational view of a left side thereof.  
 FIG. 29 is a perspective view of a fifth embodiment of a food holding bin showing our new design.  
 FIG. 30 is an elevational view of a front side thereof.  
 FIG. 31 is an elevational view of a rear side thereof.  
 FIG. 32 is a top plan view thereof.  
 FIG. 33 is a bottom plan view thereof.  
 FIG. 34 is an elevational view of a right side thereof.  
 FIG. 35 is an elevational view of a left side thereof.  
 FIG. 36 is a perspective view of a sixth embodiment of a food holding bin showing our new design.  
 FIG. 37 is an elevational view of a front side thereof.  
 FIG. 38 is an elevational view of a rear side thereof.  
 FIG. 39 is a top plan view thereof.  
 FIG. 40 is a bottom plan view thereof.  
 FIG. 41 is an elevational view of a right side thereof.  
 FIG. 42 is an elevational view of a left side thereof.  
 FIG. 43 is a perspective view of a seventh embodiment of a food holding bin showing our new design.  
 FIG. 44 is an elevational view of a front side thereof.  
 FIG. 45 is an elevational view of a rear side thereof.  
 FIG. 46 is a top plan view thereof.  
 FIG. 47 is a bottom plan view thereof.  
 FIG. 48 is an elevational view of a right side thereof.  
 FIG. 49 is an elevational view of a left side thereof.  
 FIG. 50 is a perspective view of an eighth embodiment of a food holding bin showing our new design.  
 FIG. 51 is an elevational view of a front side thereof.  
 FIG. 52 is an elevational view of a rear side thereof.  
 FIG. 53 is a top plan view thereof.  
 FIG. 54 is a bottom plan view thereof.  
 FIG. 55 is an elevational view of a right side thereof.  
 FIG. 56 is an elevational view of a left side thereof.  
 FIG. 57 is a perspective view of a ninth embodiment of a food holding bin showing our new design.  
 FIG. 58 is an elevational view of a front side thereof.  
 FIG. 59 is an elevational view of a rear side thereof.  
 FIG. 60 is a top plan view thereof.  
 FIG. 61 is a bottom plan view thereof.  
 FIG. 62 is an elevational view of a right side thereof; and,  
 FIG. 63 is an elevational view of a left side thereof.  
 FIGS. 1-28 are shown with a symbolic break in its length and width. The appearance of any portion of the article between the break lines forms no part of the claimed design. The broken lines show portions of the food holding bin that form no part of the claimed design.

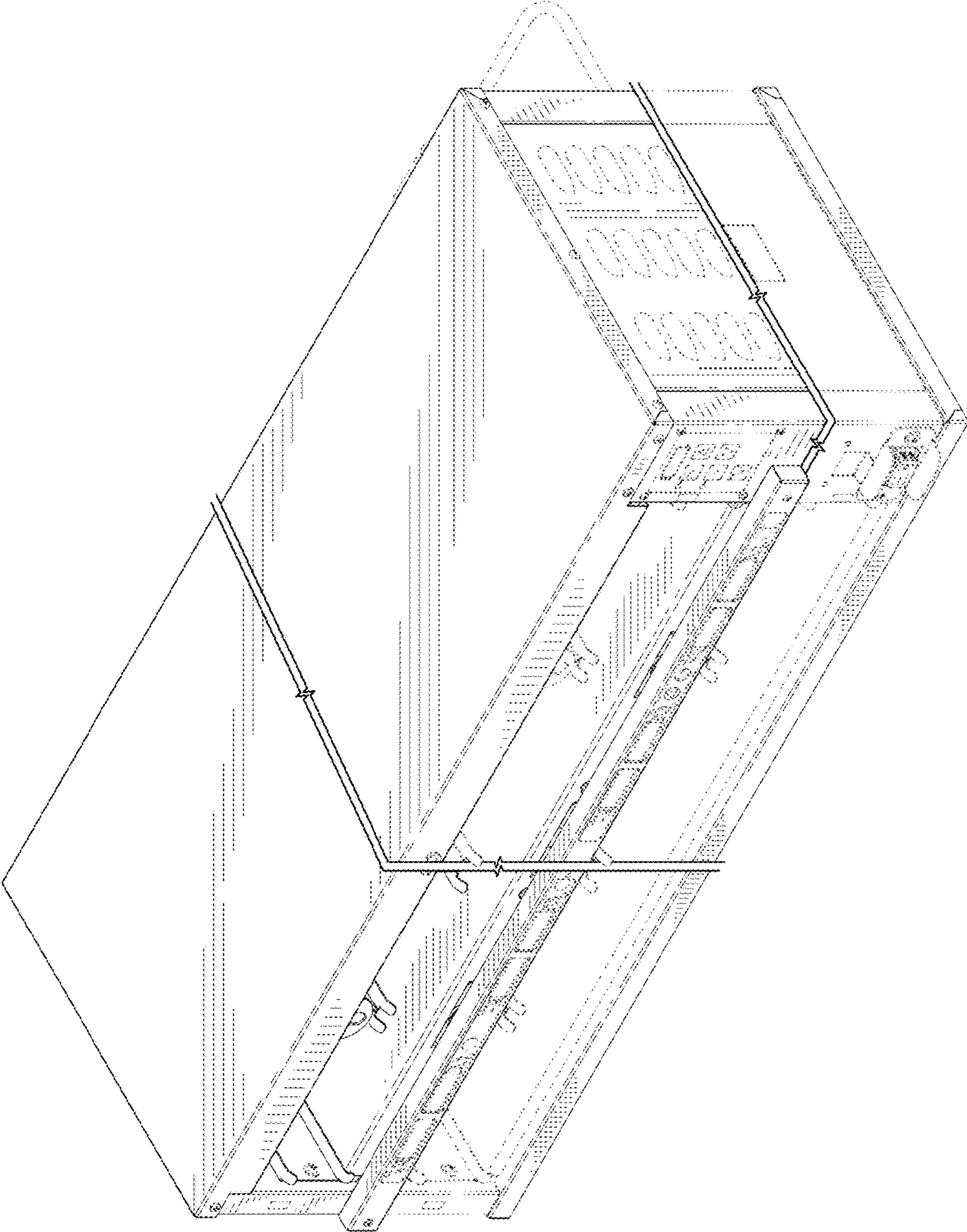

FIG. 1

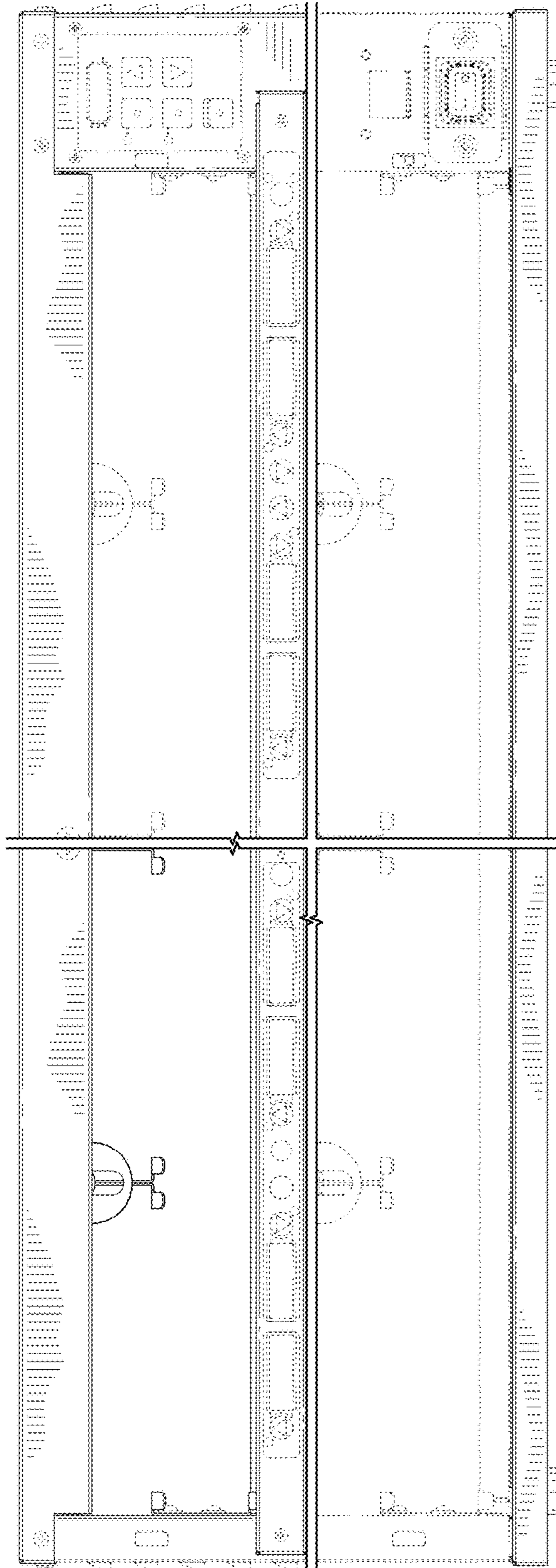

FIG. 2

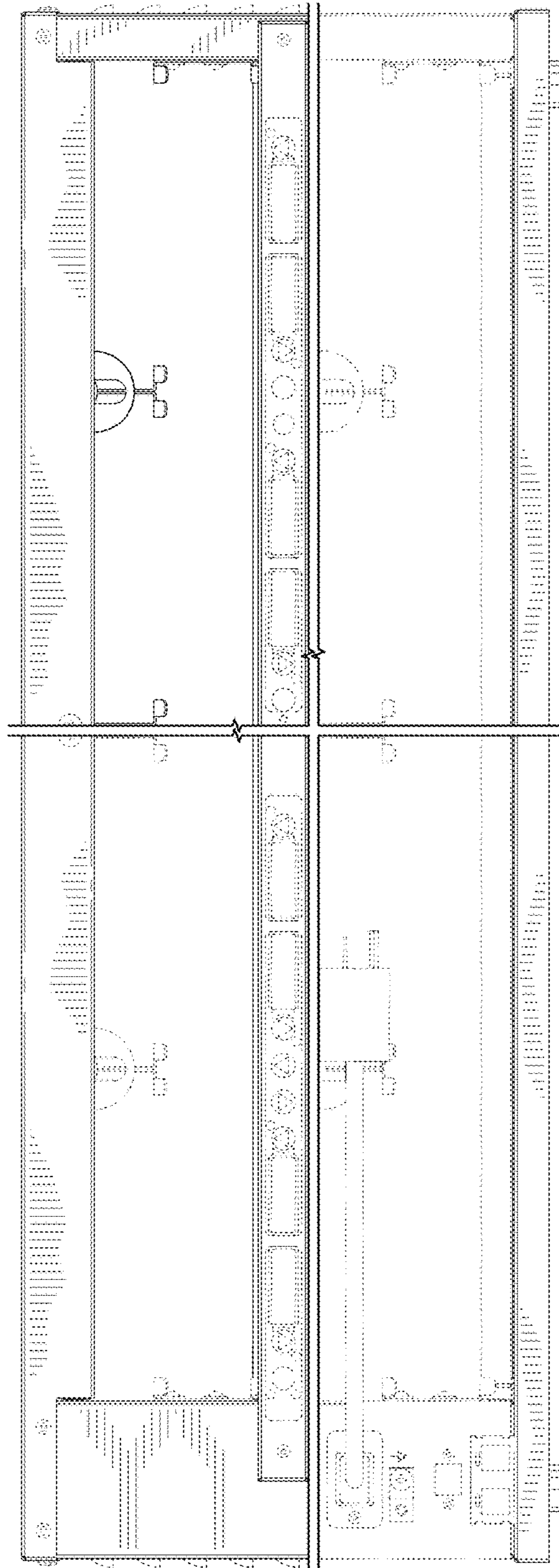

FIG. 3

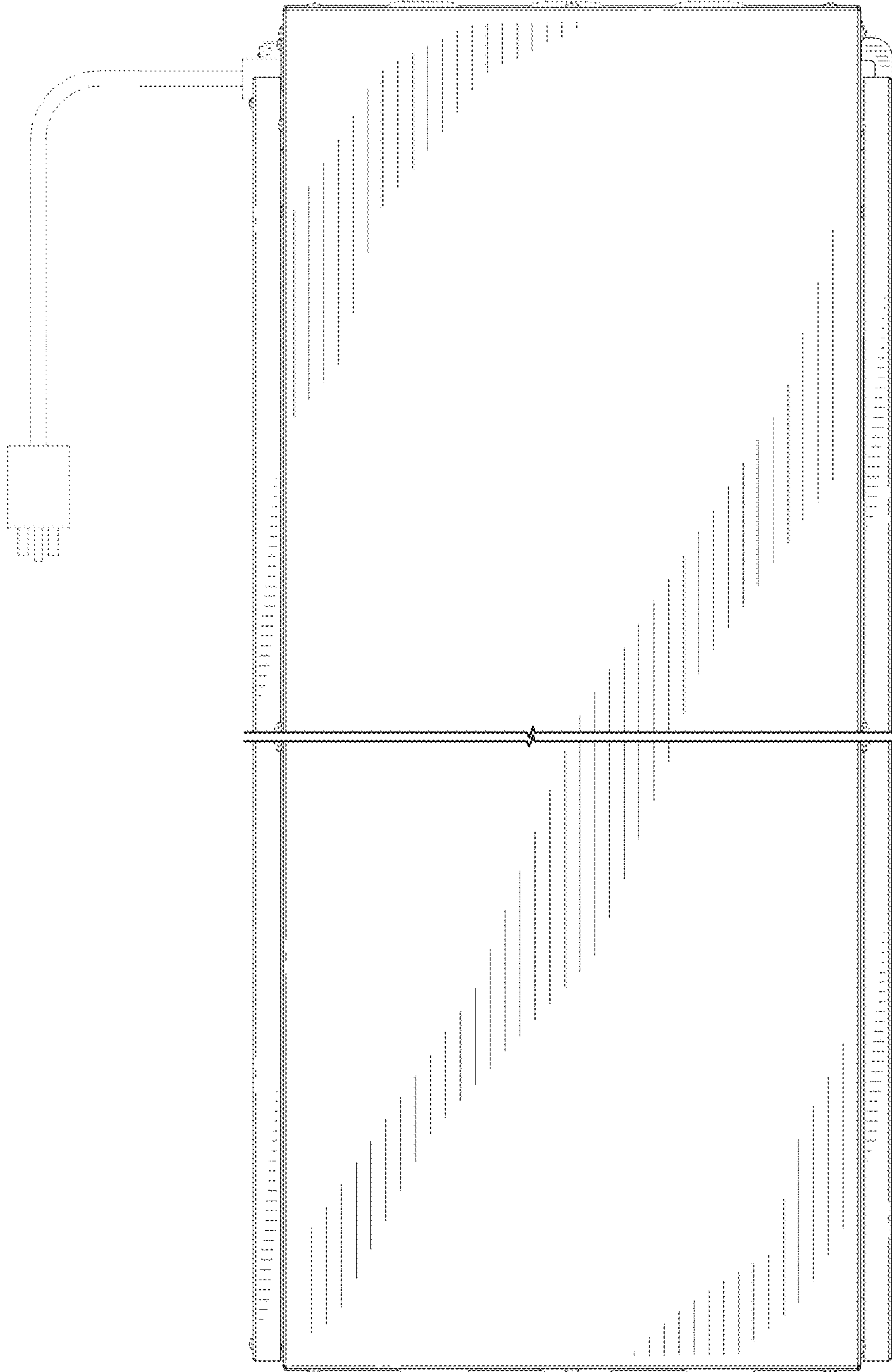

FIG. 4

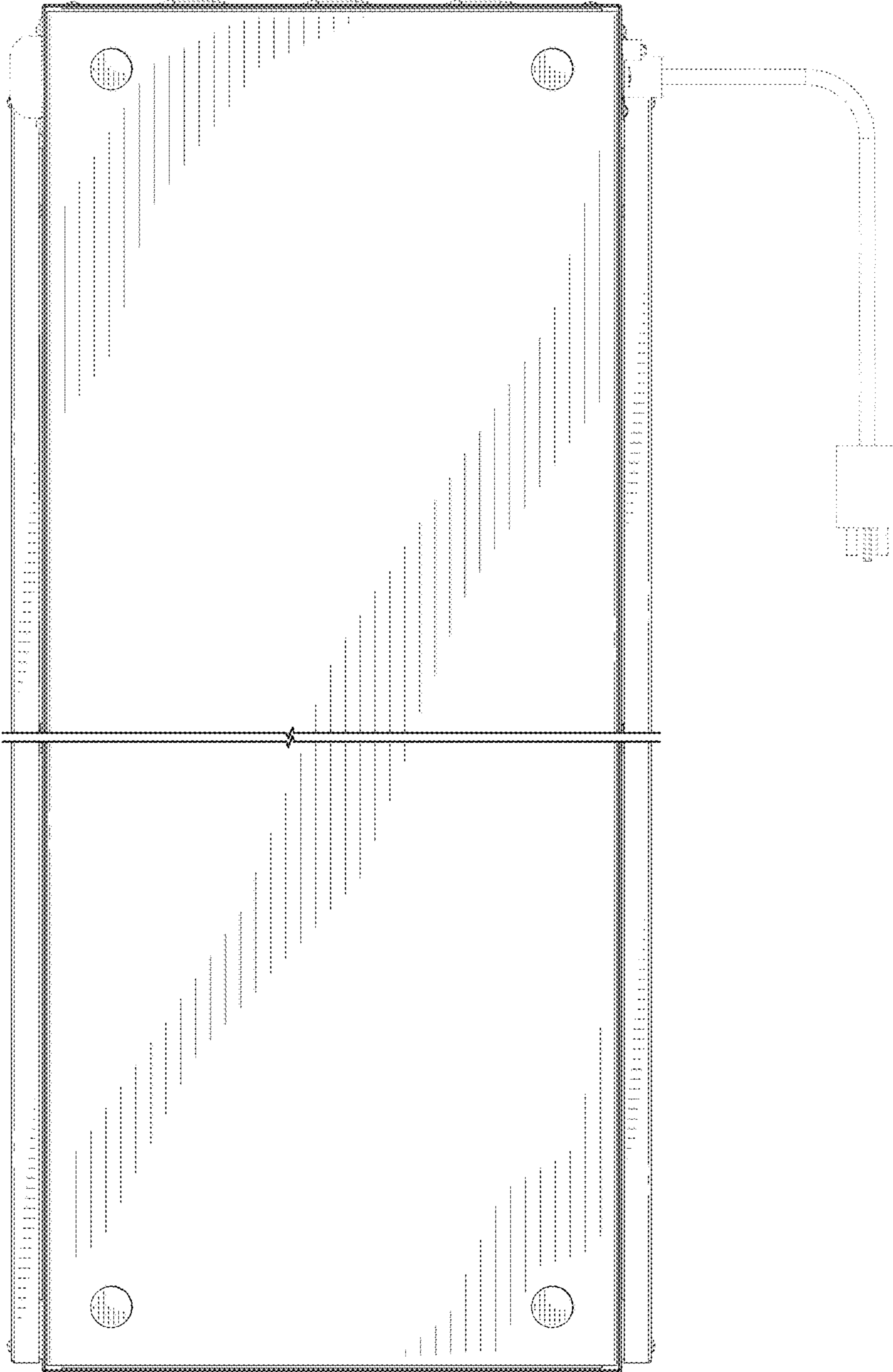

FIG. 5



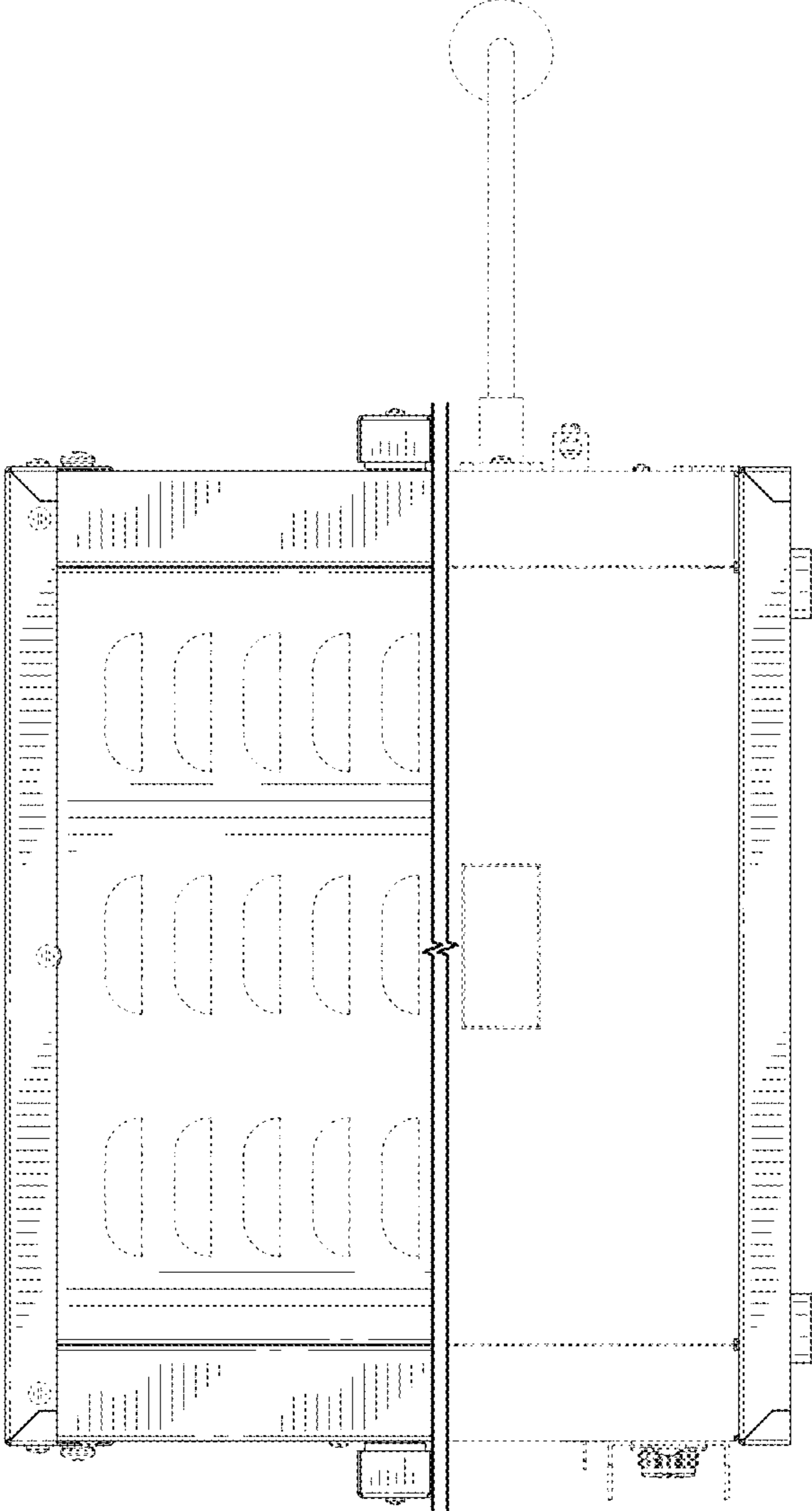

FIG. 6

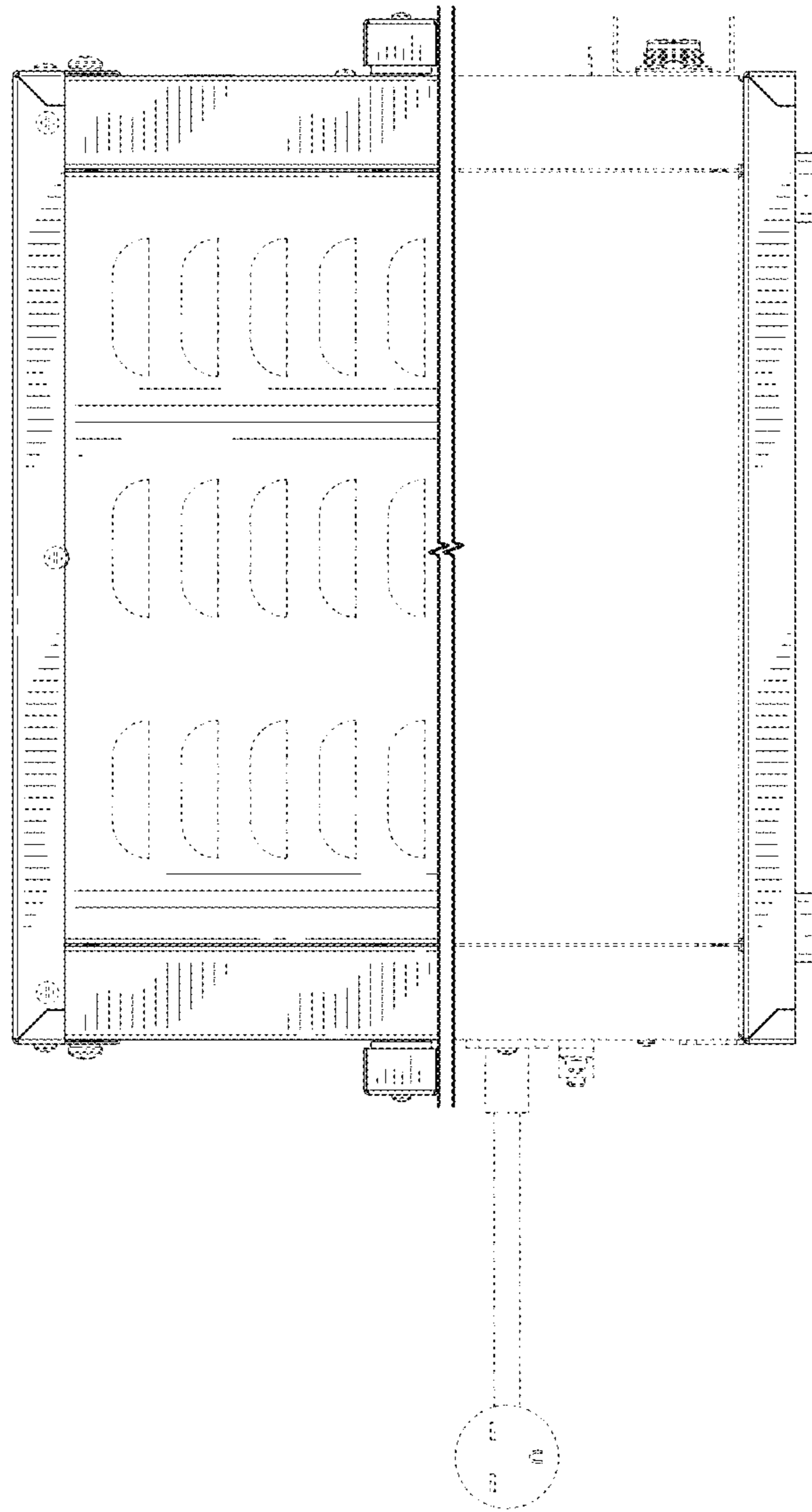

FIG. 7

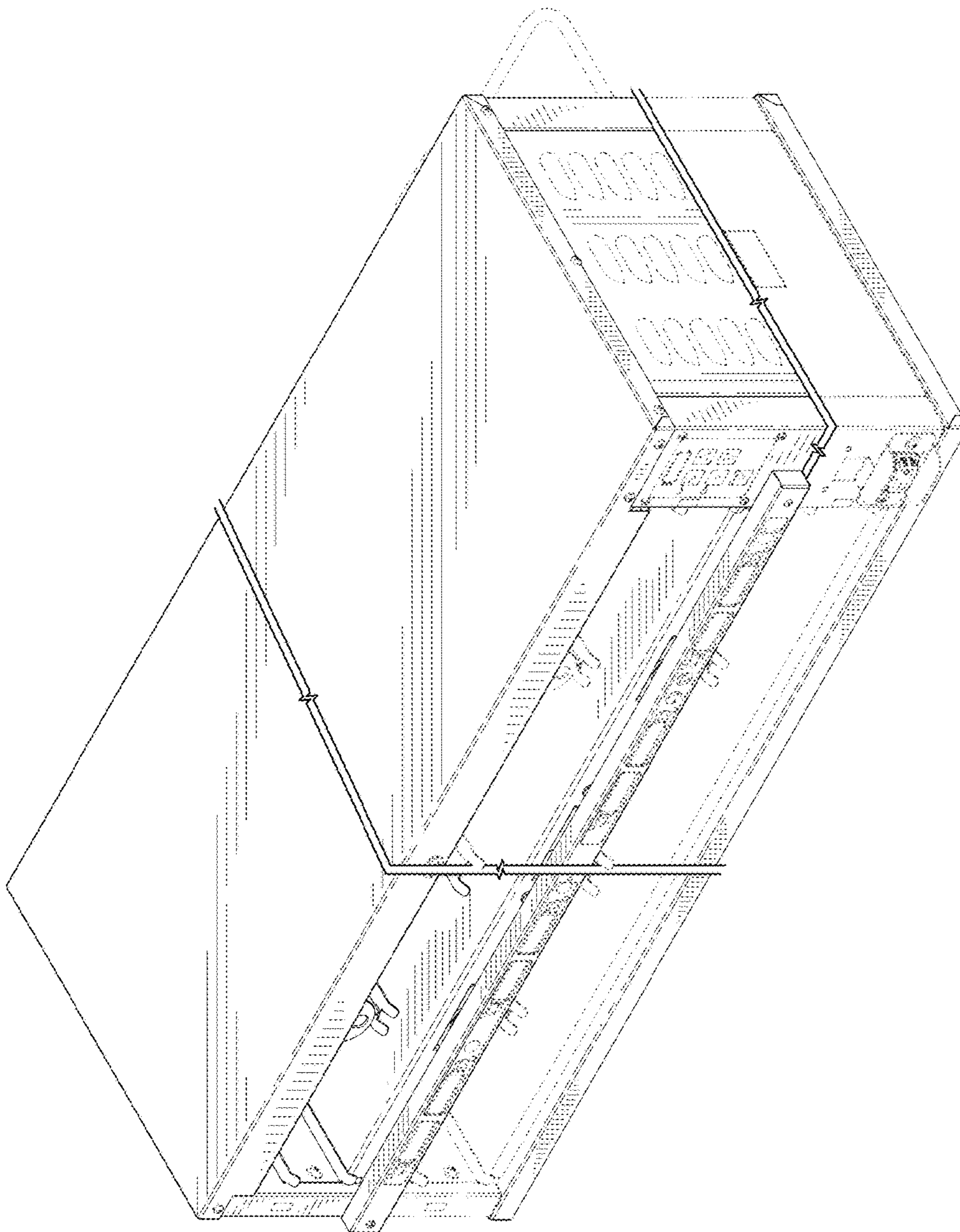

FIG. 8

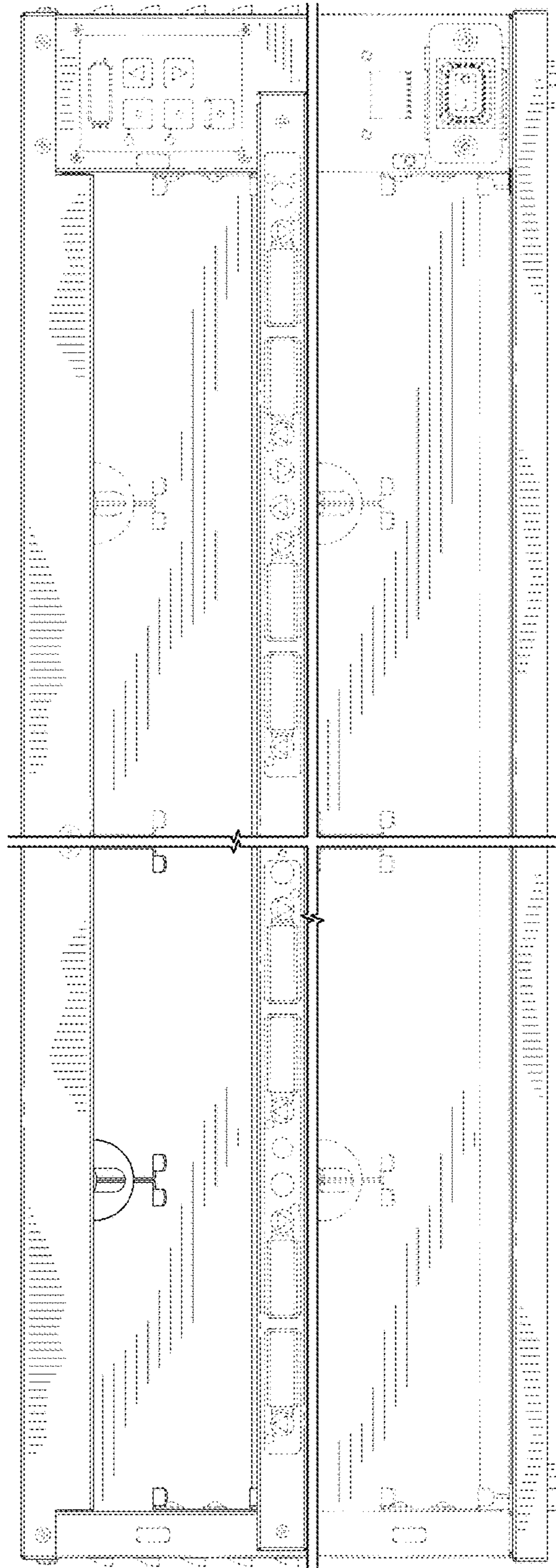

FIG. 9

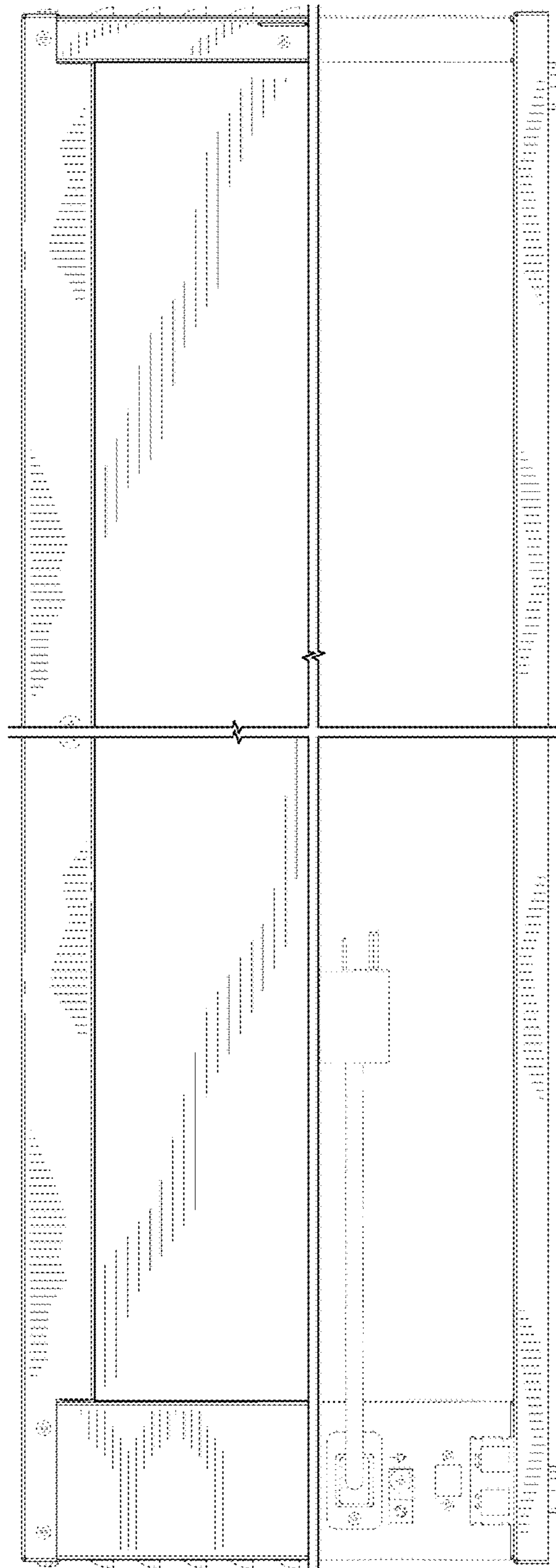

FIG. 10

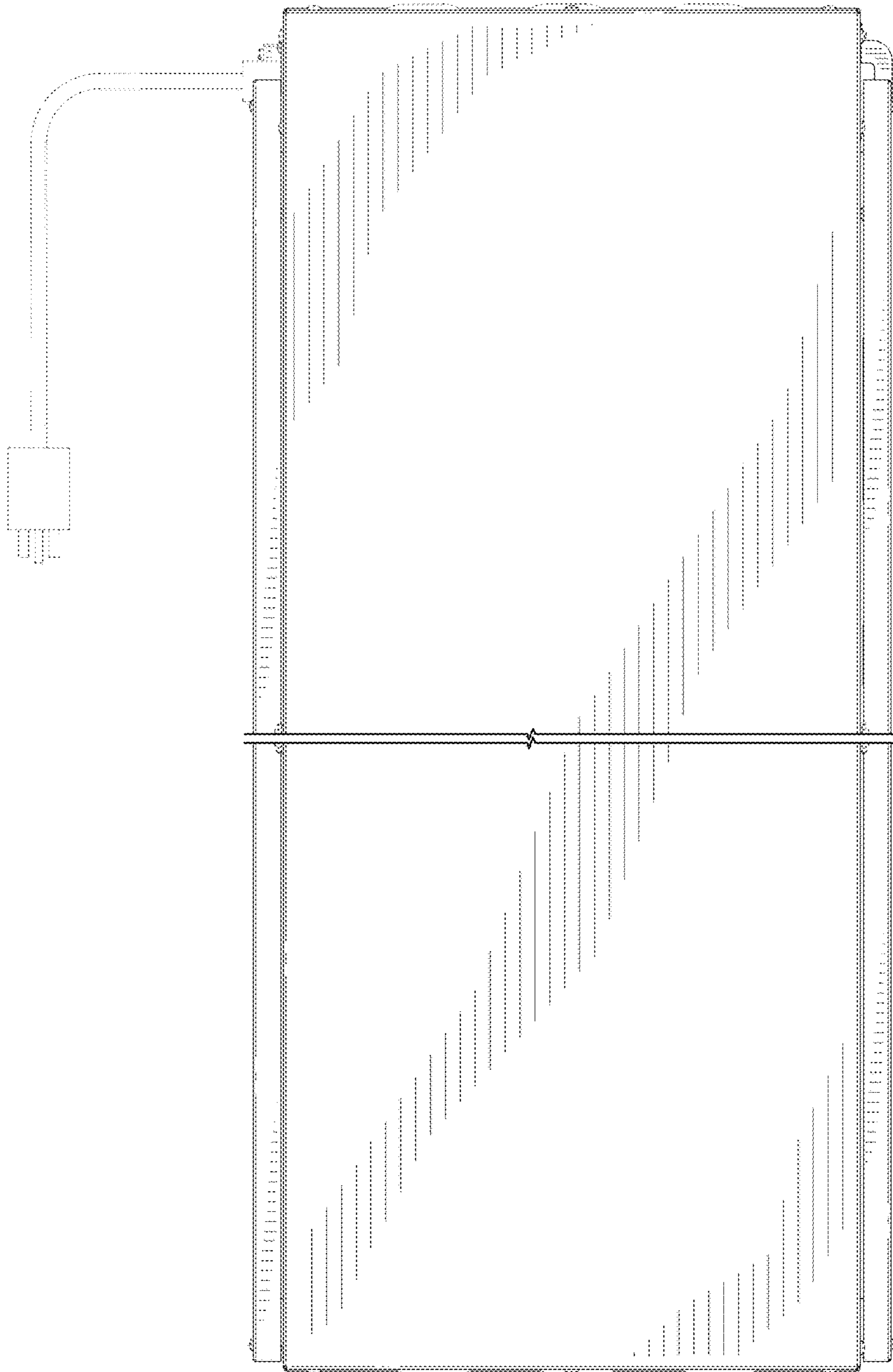

FIG. 11

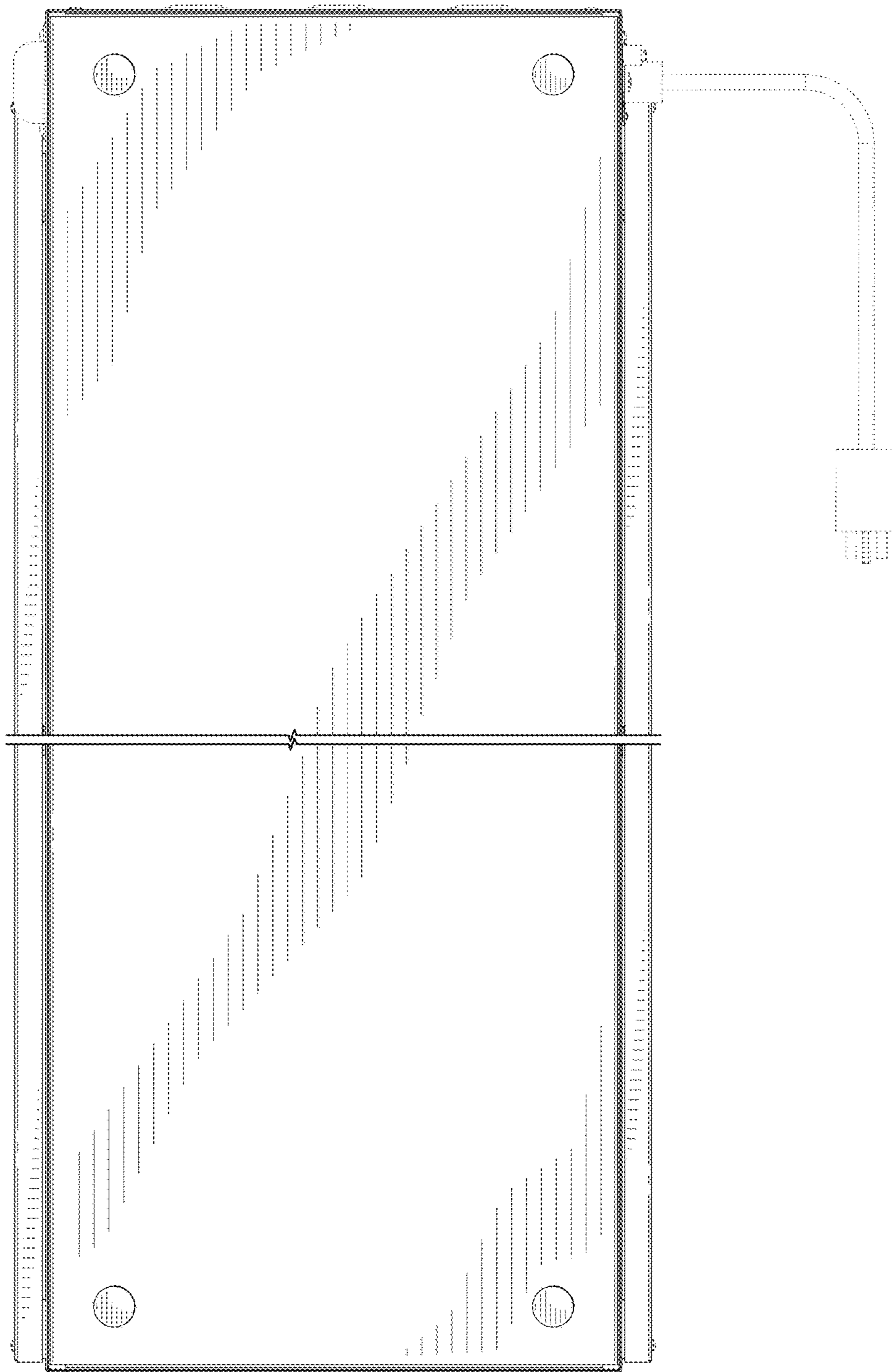

FIG. 12

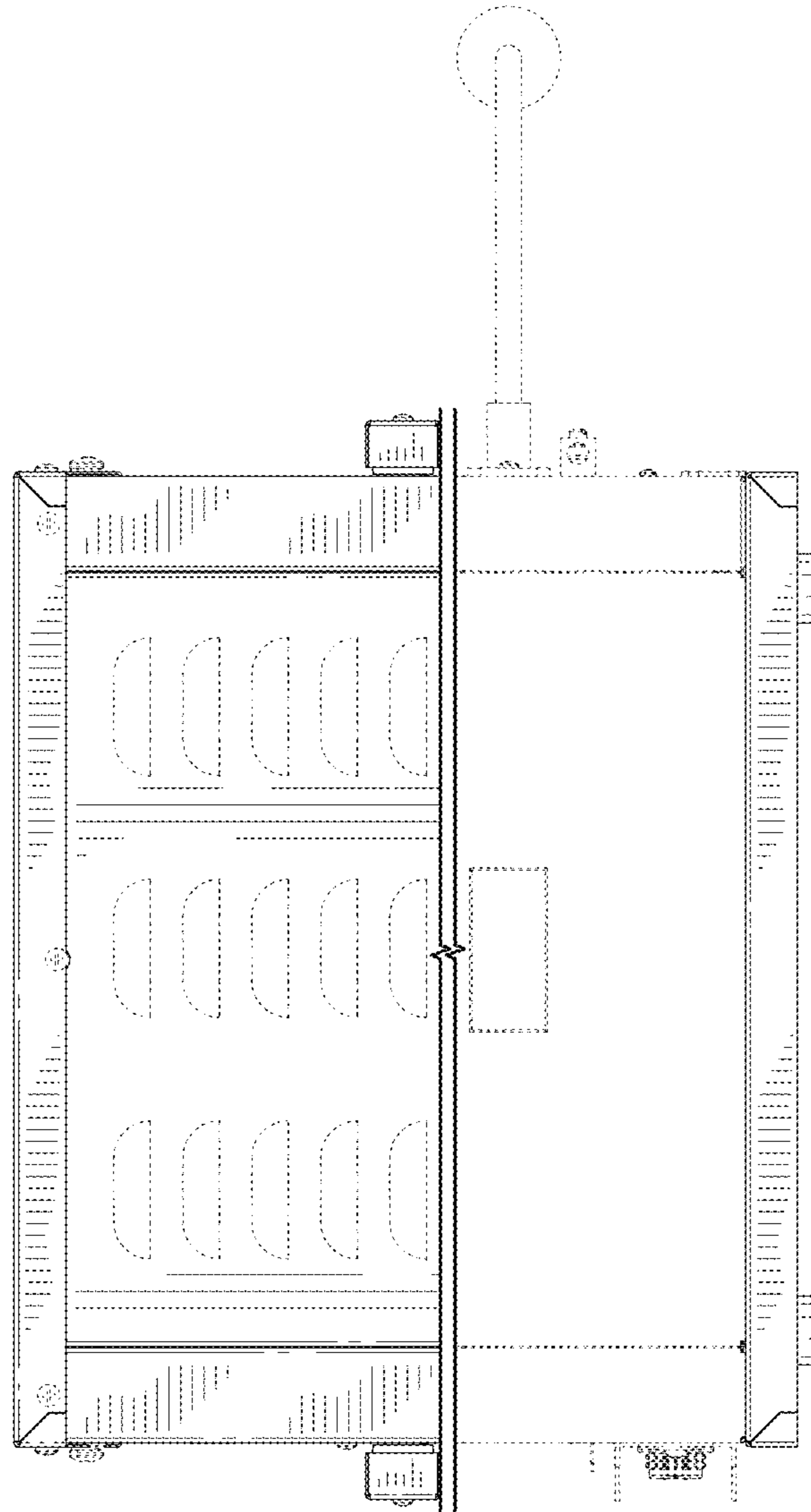

FIG. 13



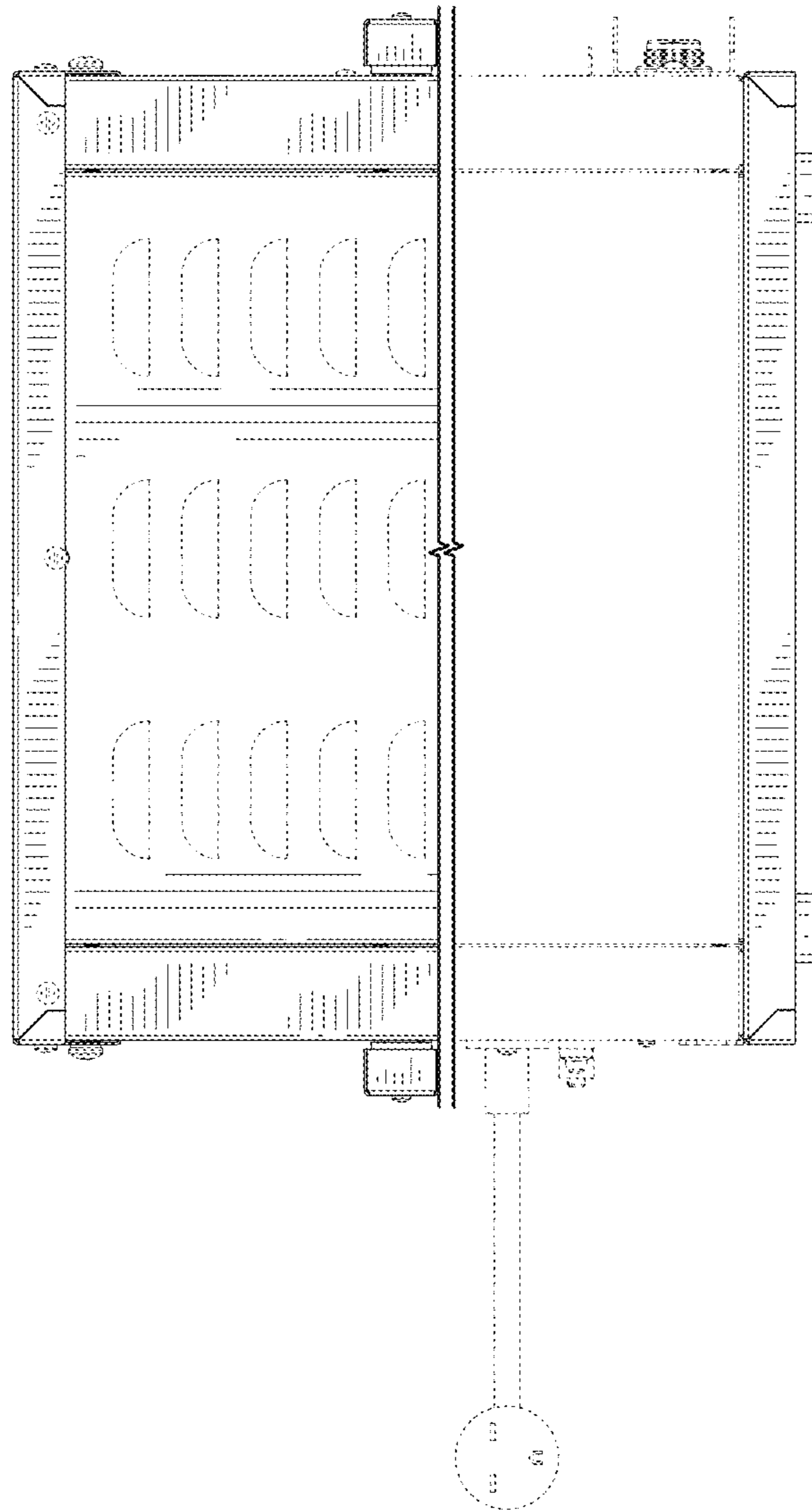

FIG. 14

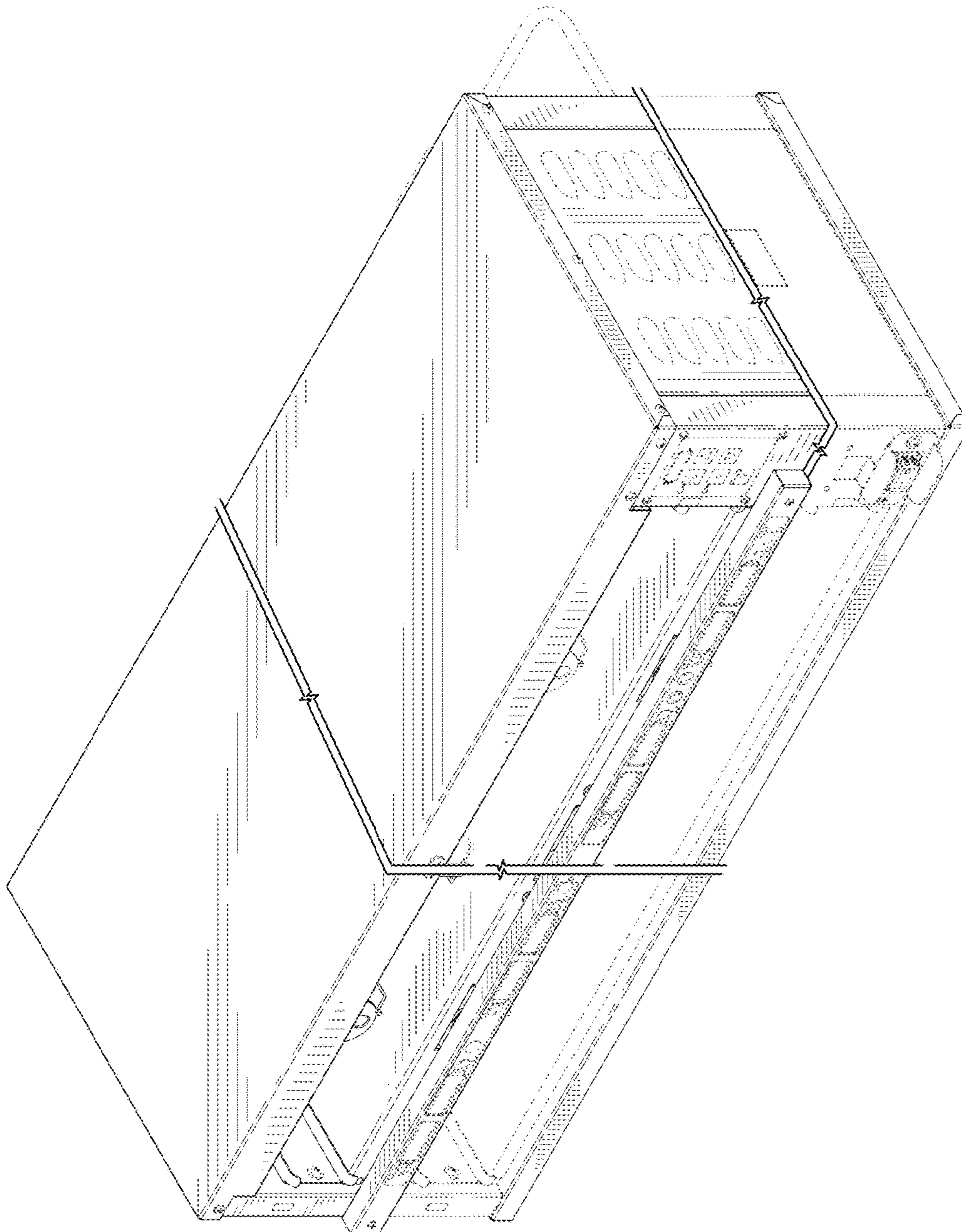

FIG. 15

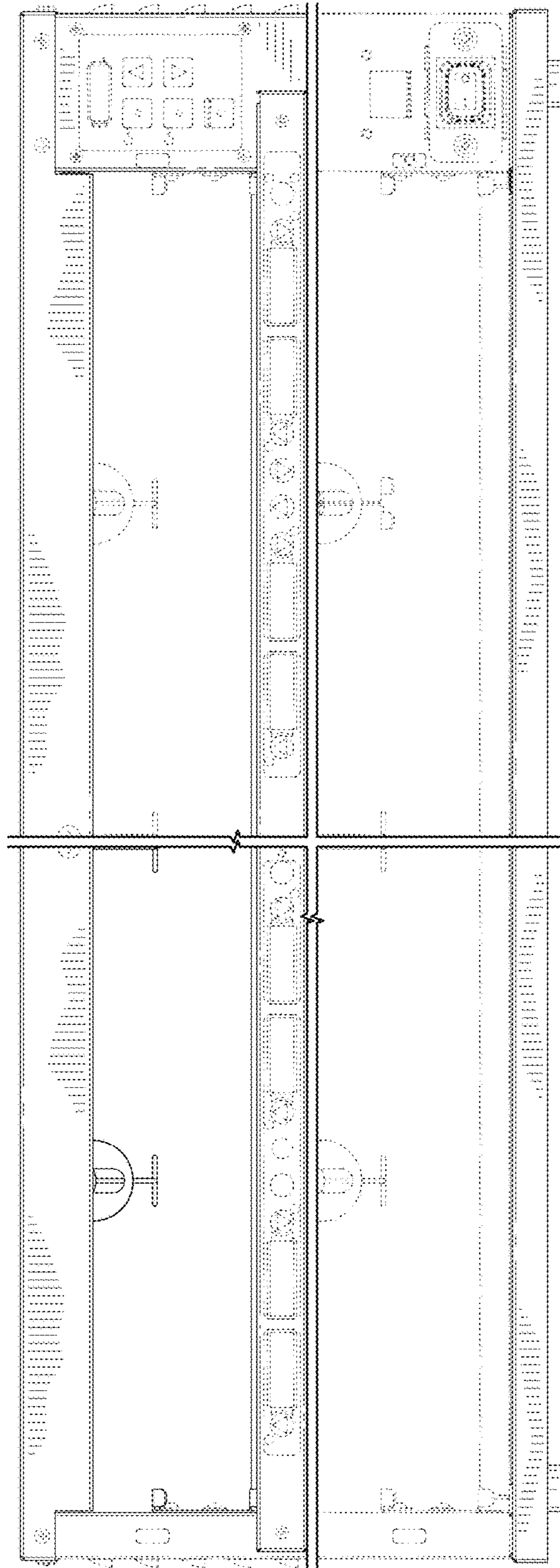

FIG. 16

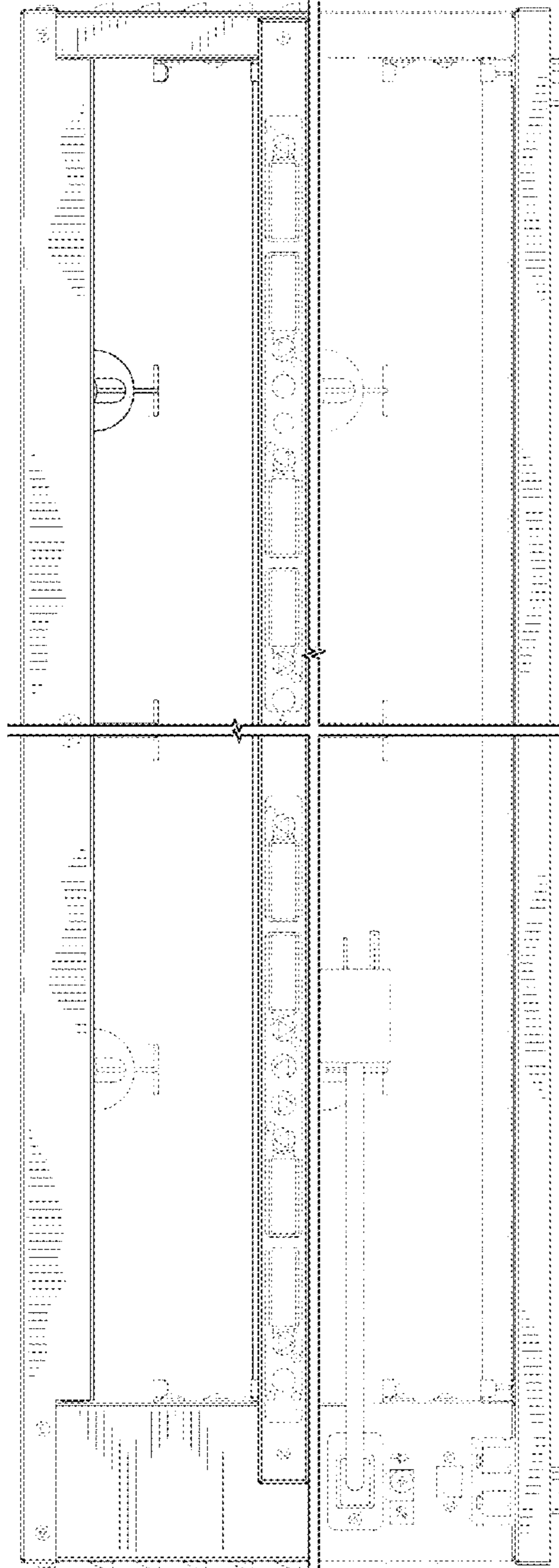

FIG. 17

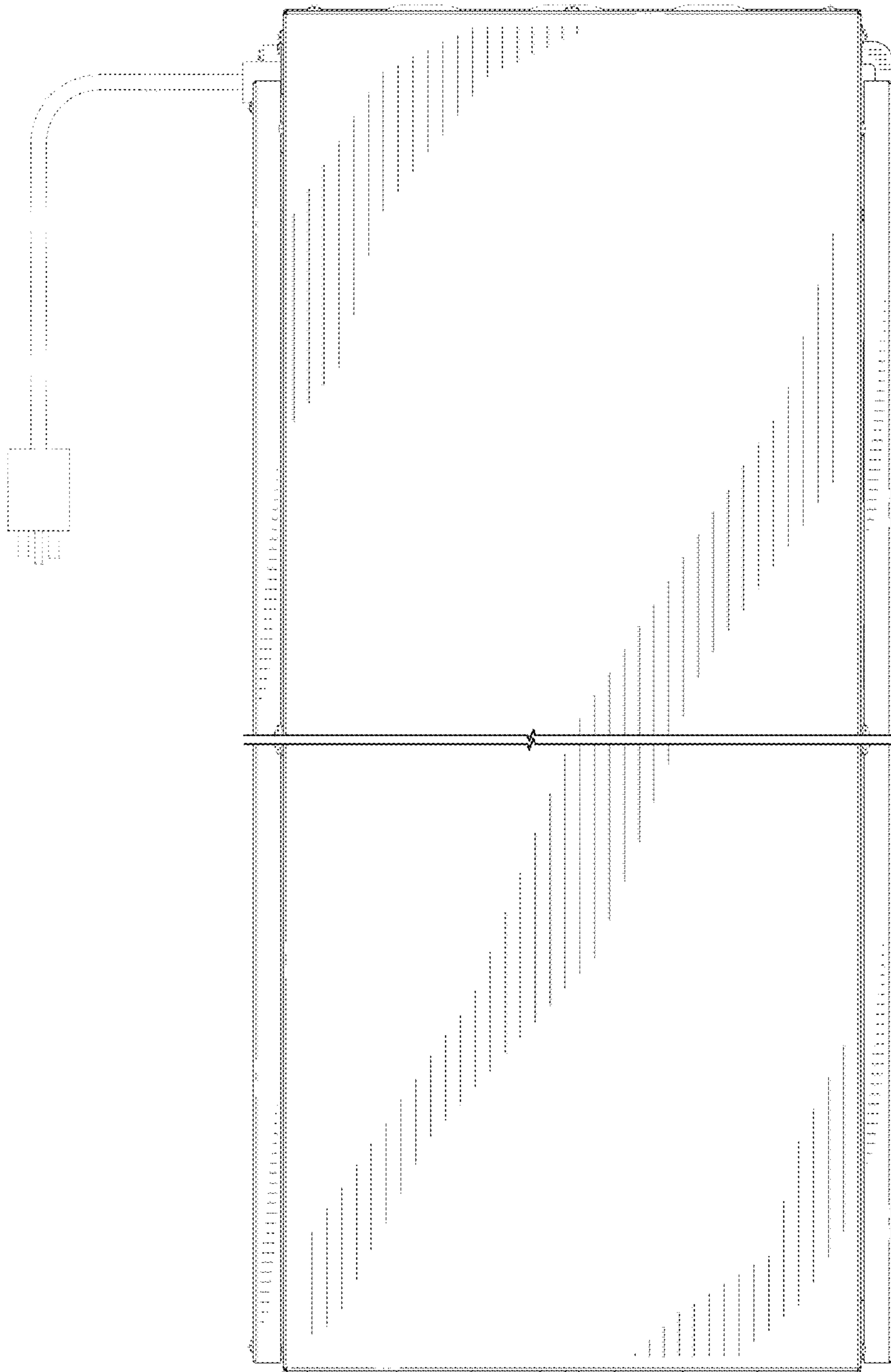

FIG. 18

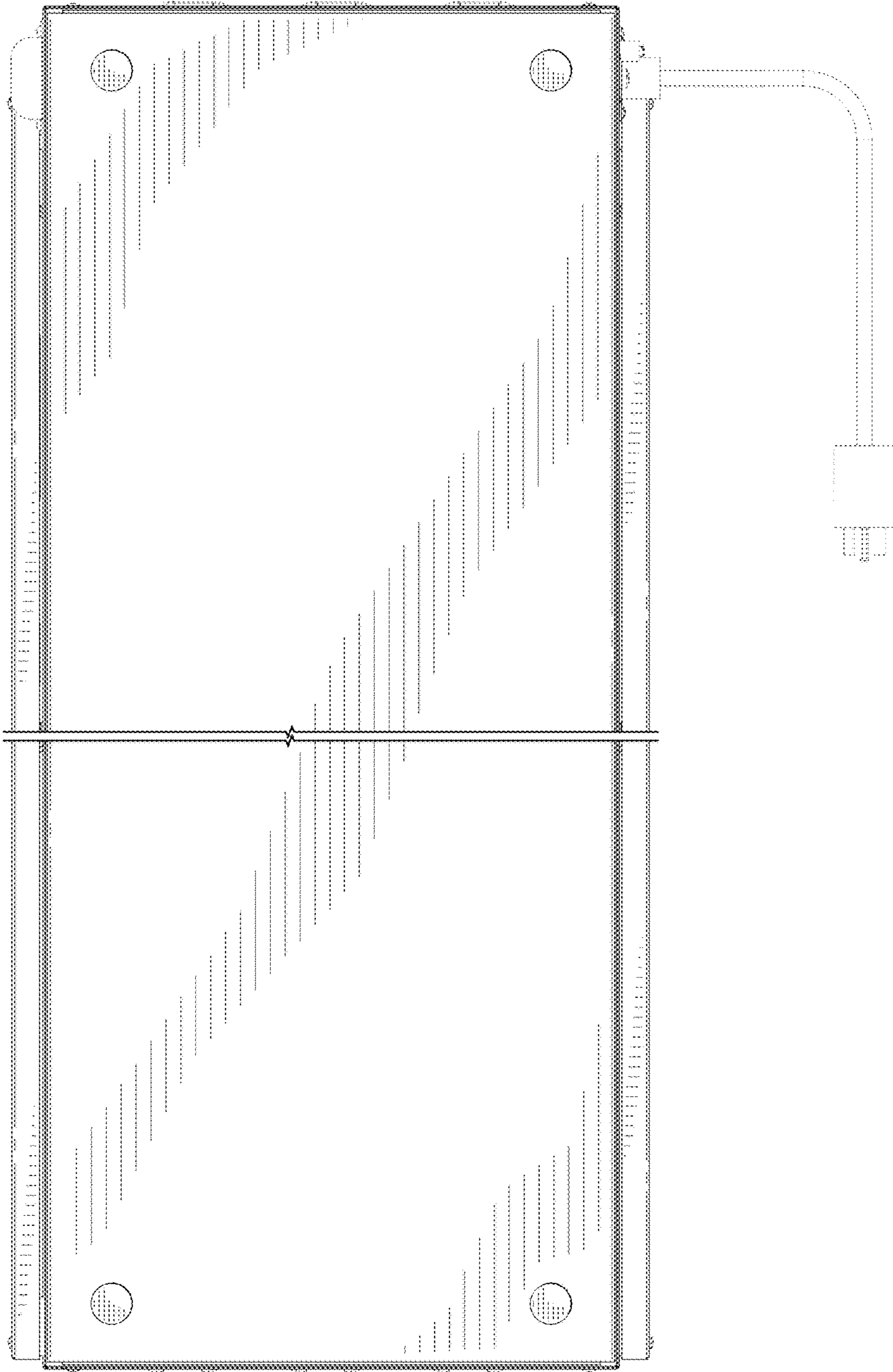

FIG. 19

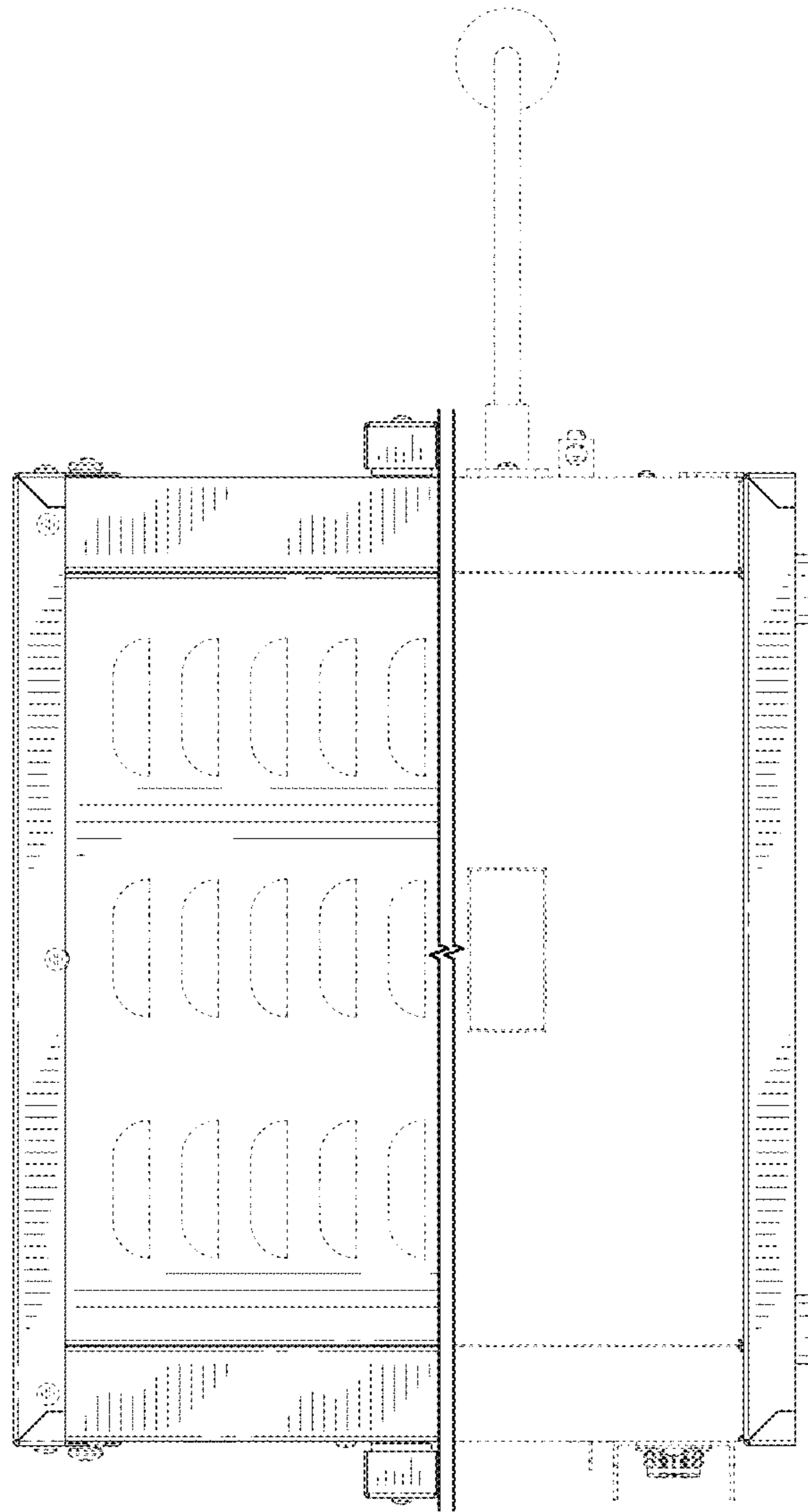

FIG. 20

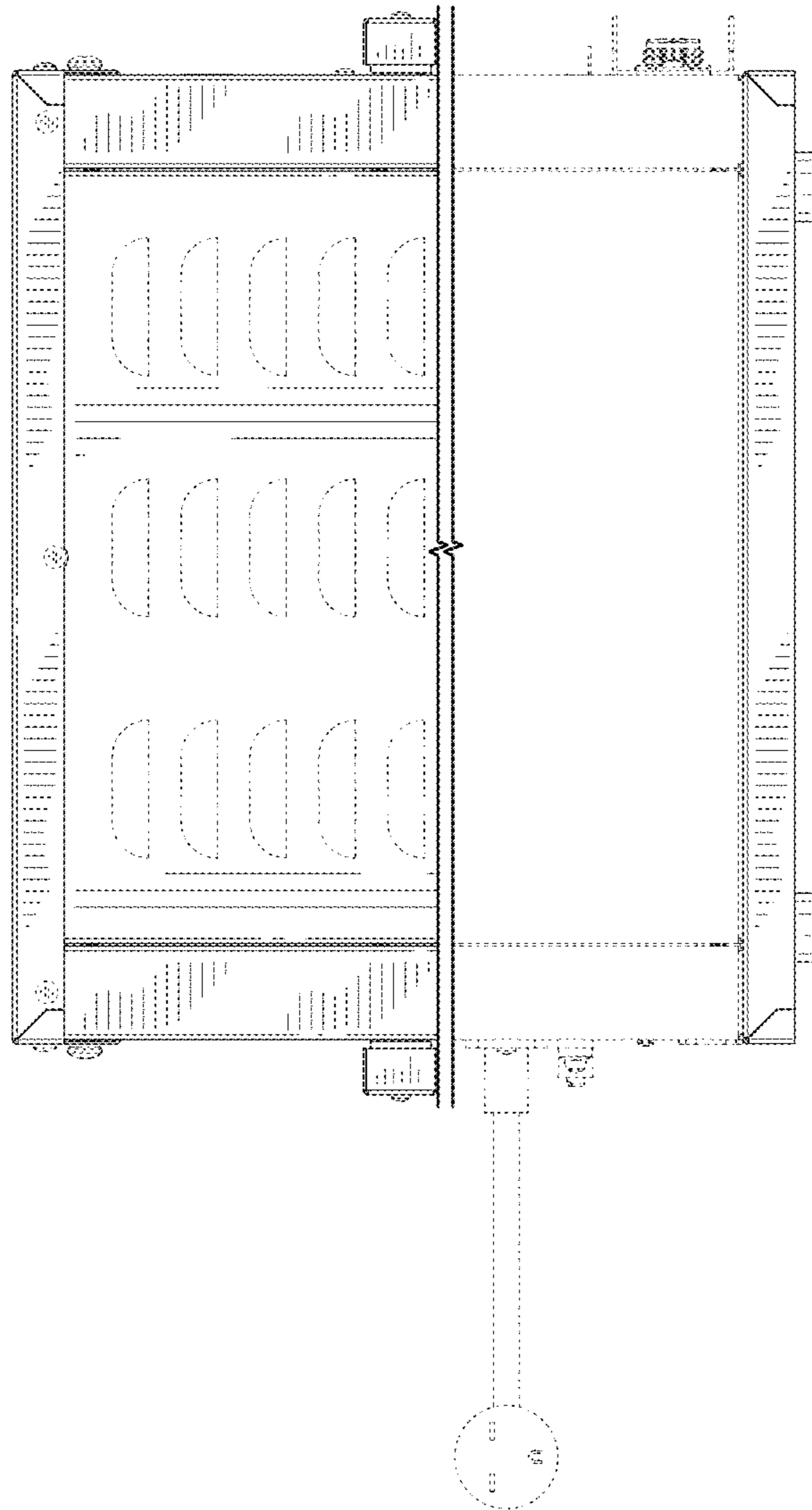

FIG. 21



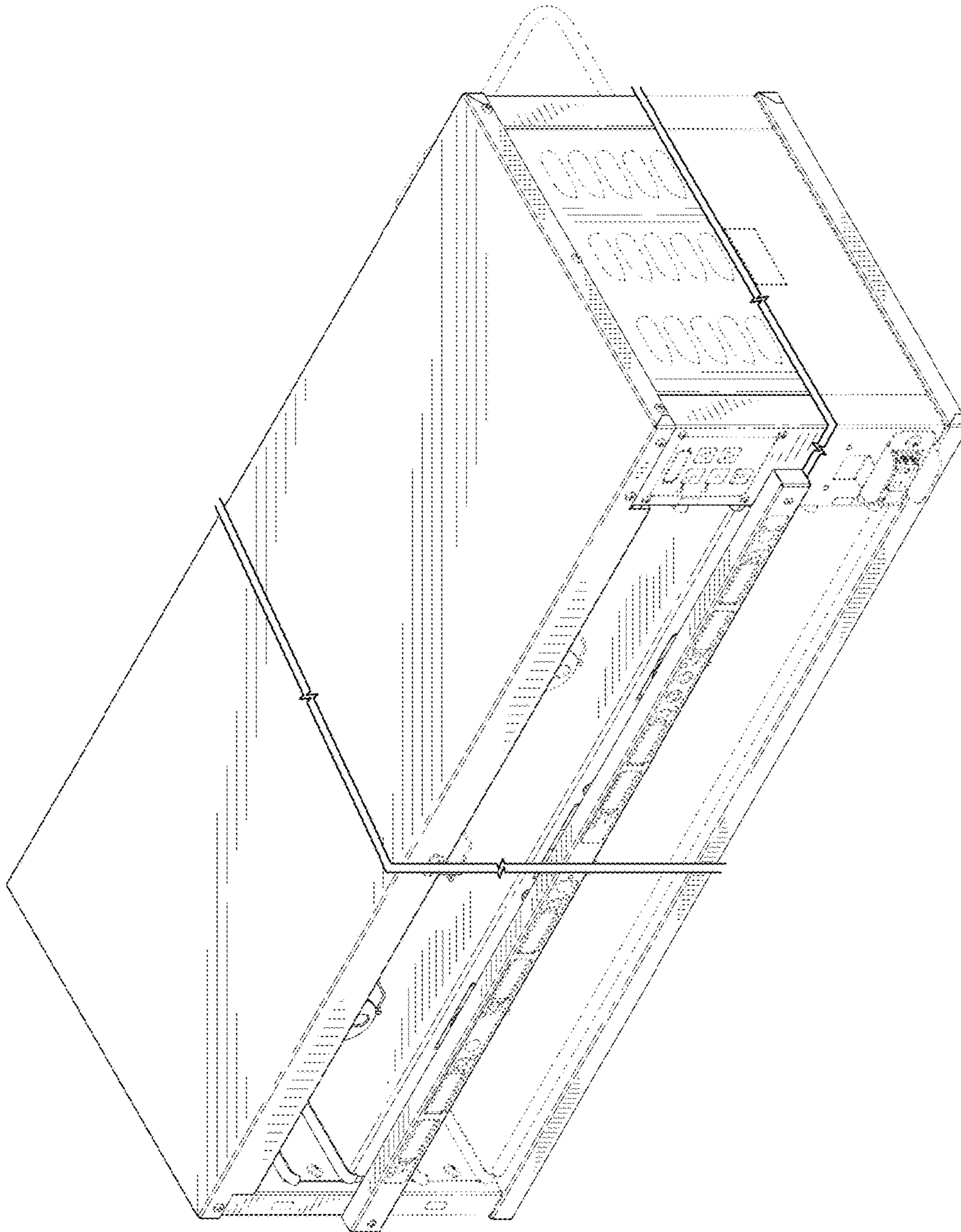

FIG. 22

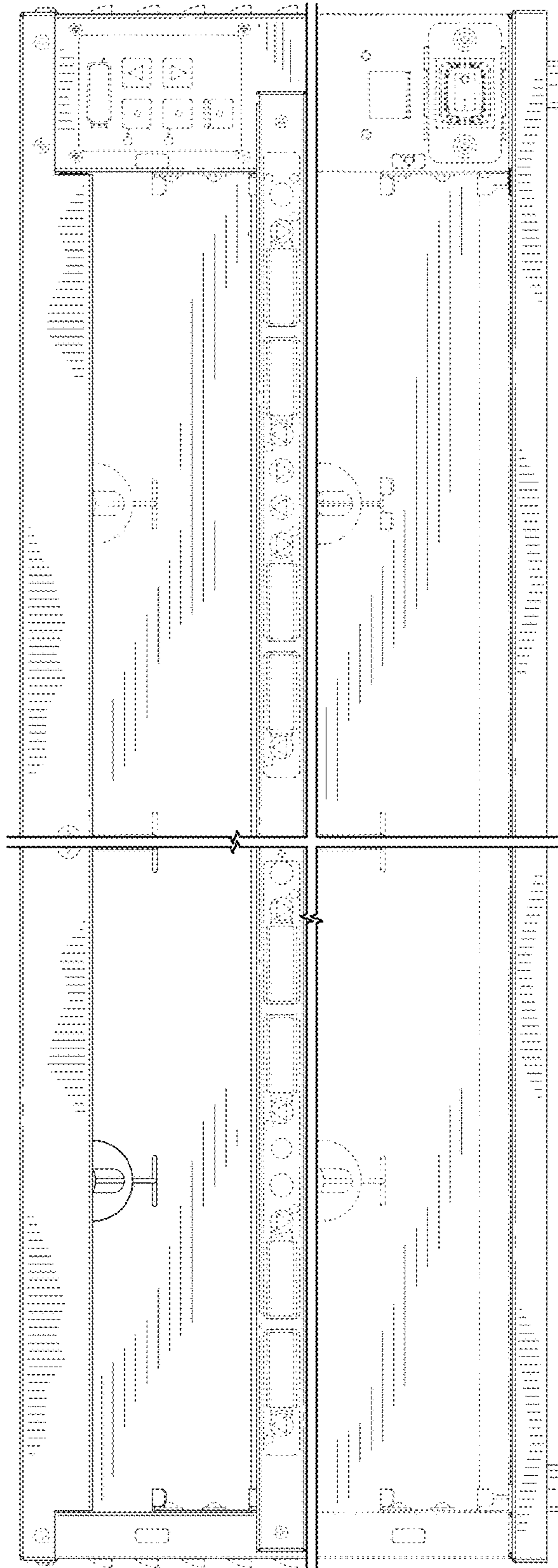

FIG. 23

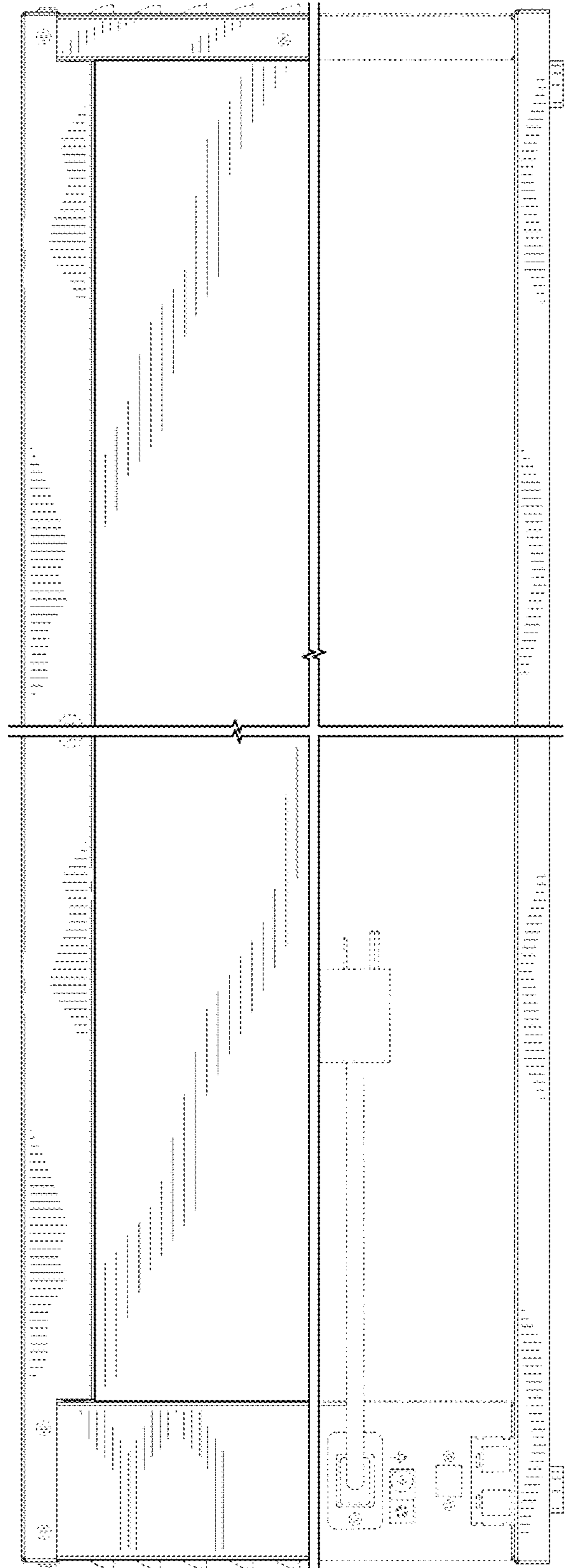

FIG. 24

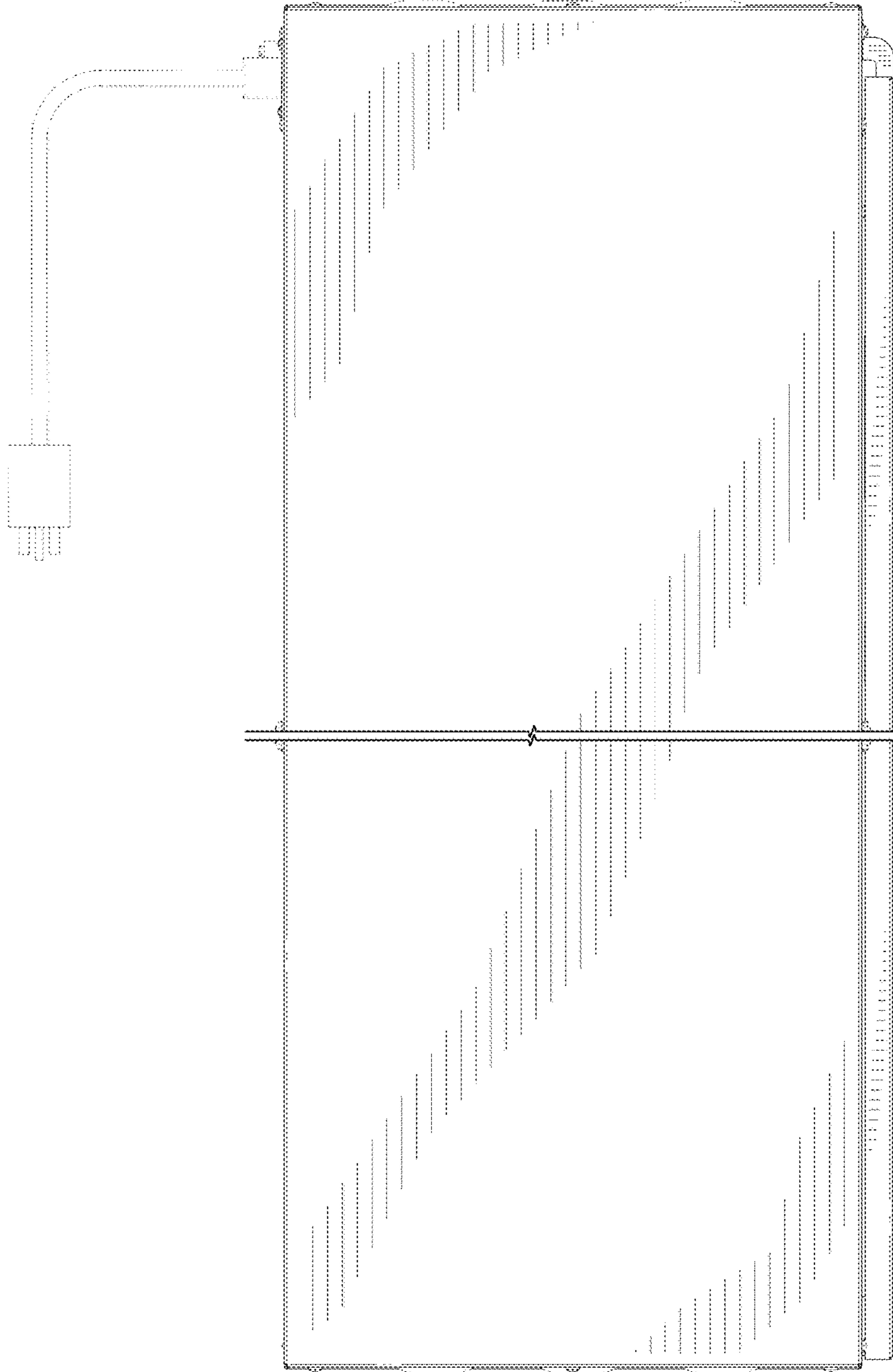

FIG. 25

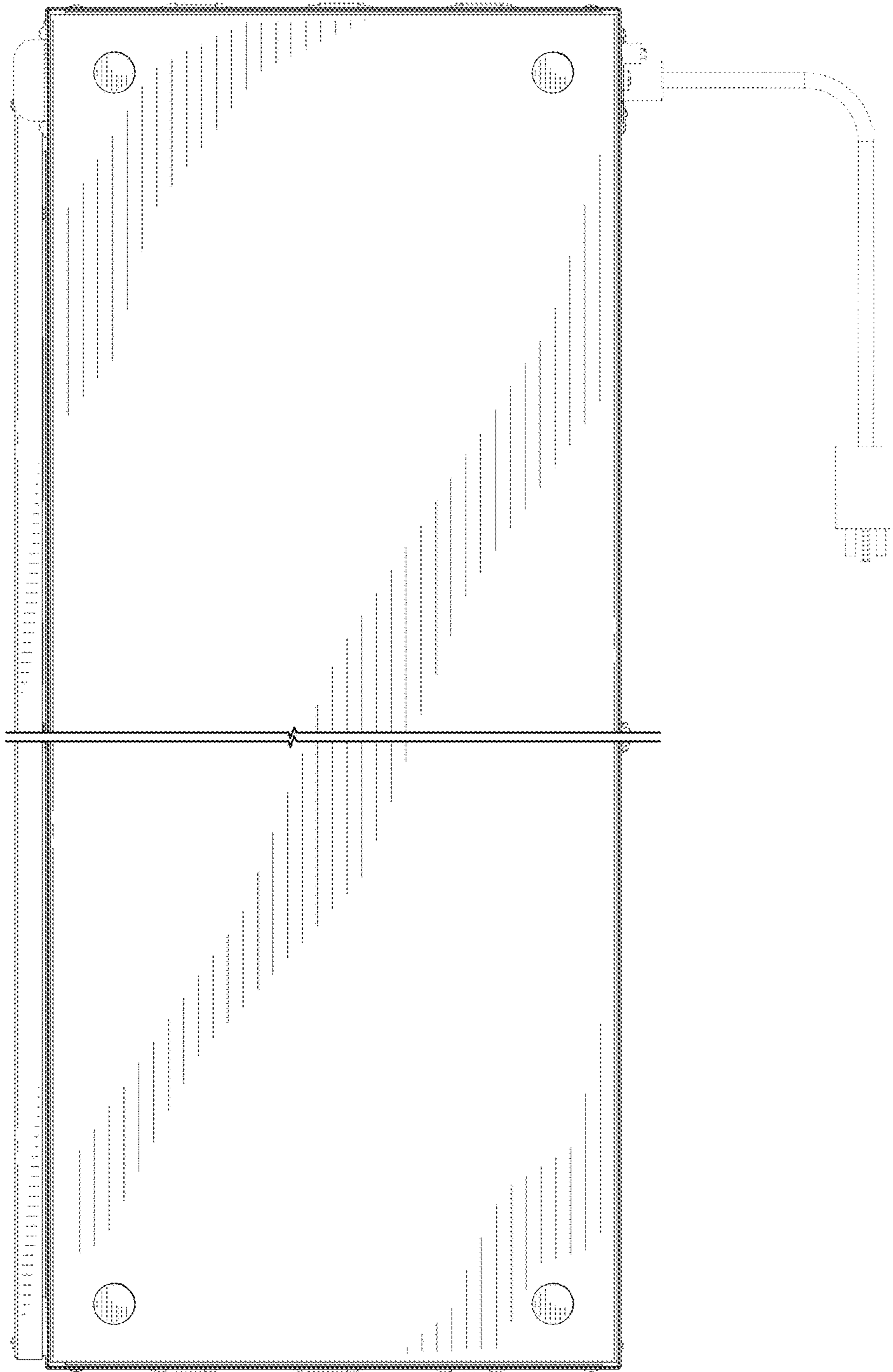

FIG. 26

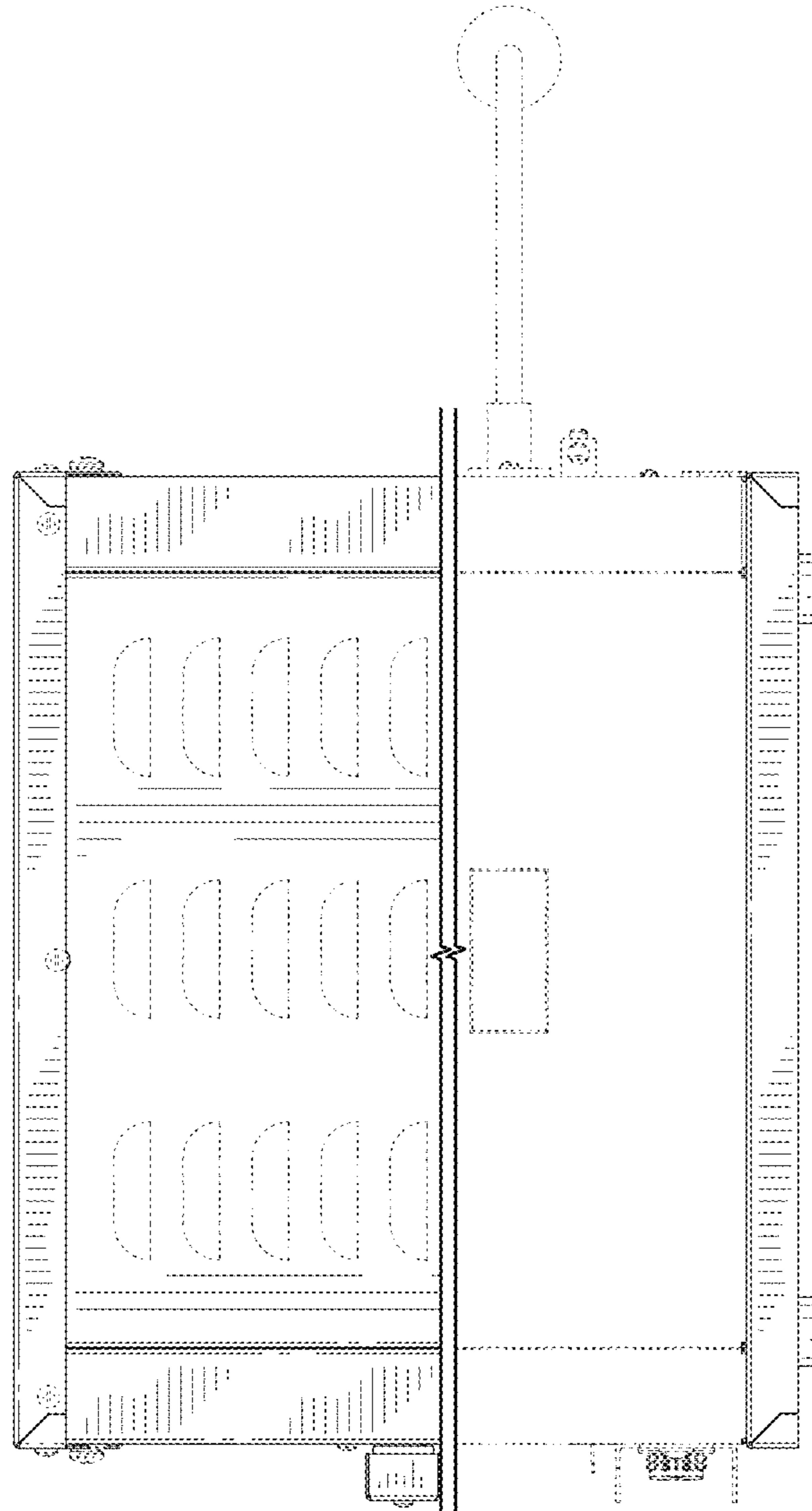

FIG. 27

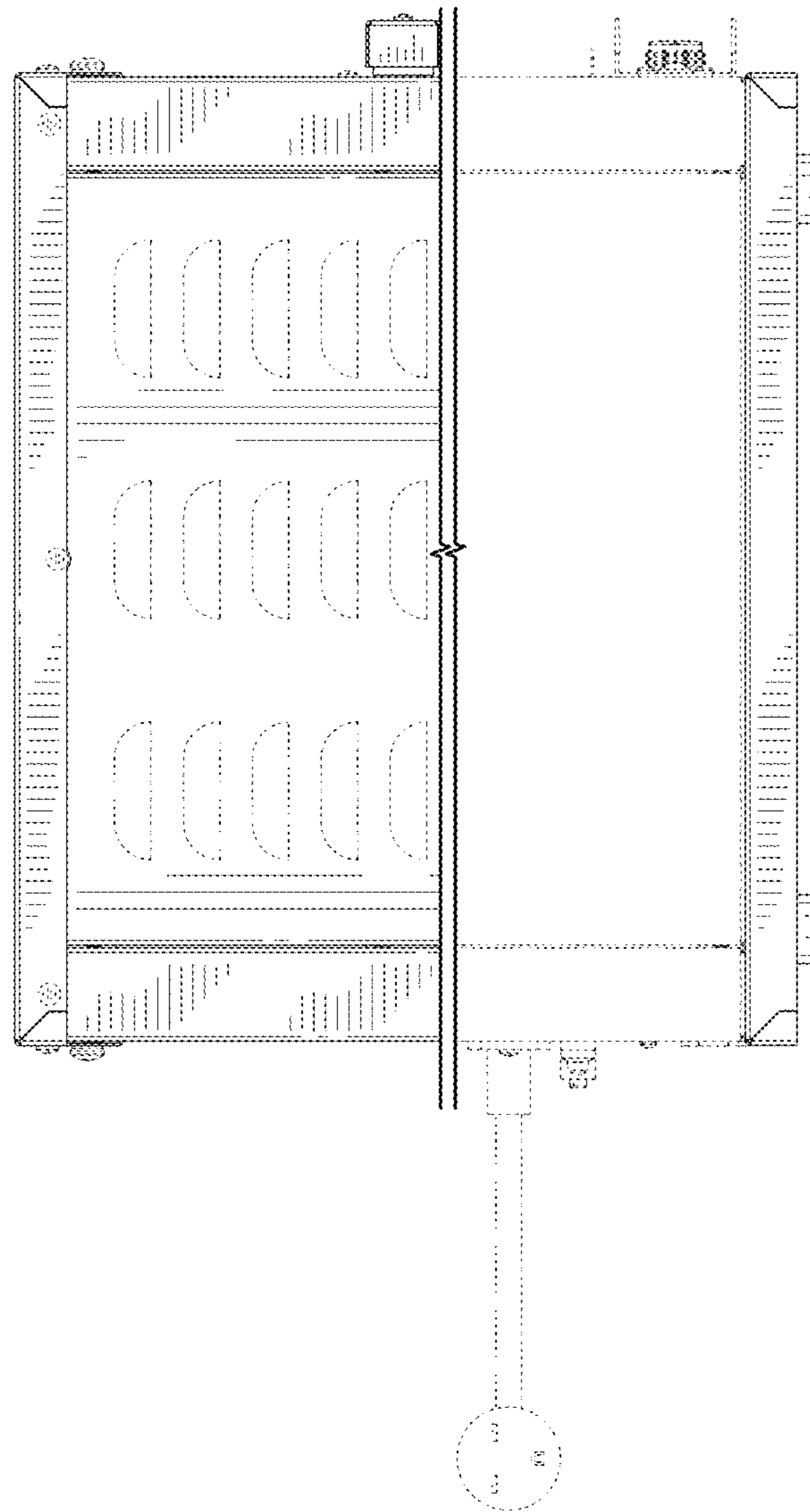

FIG. 28

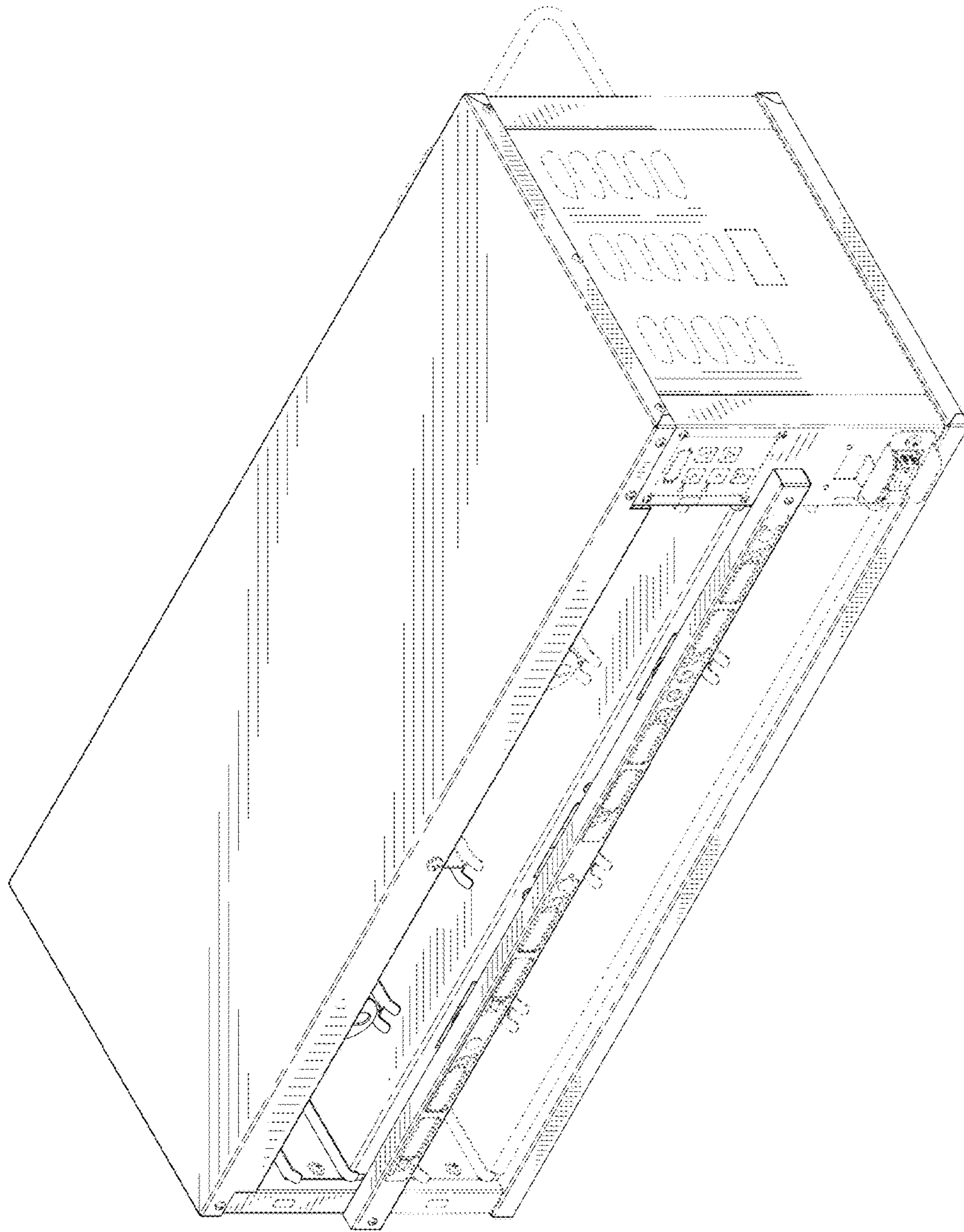

FIG. 29



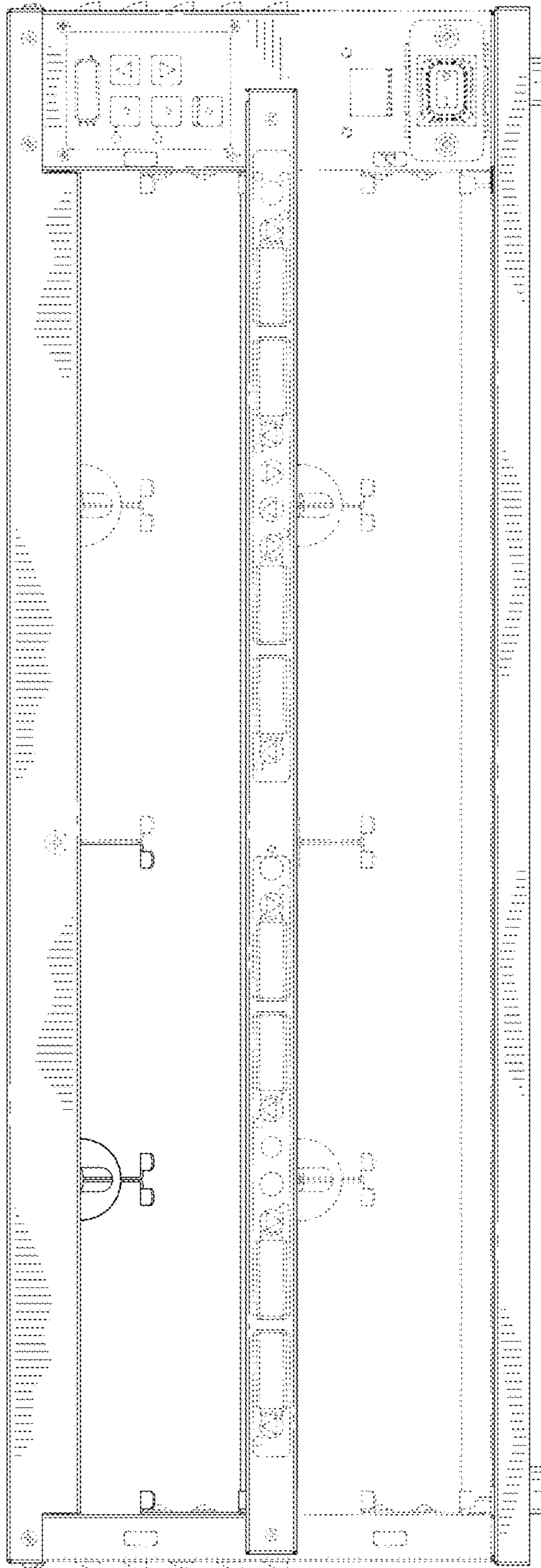

FIG. 30

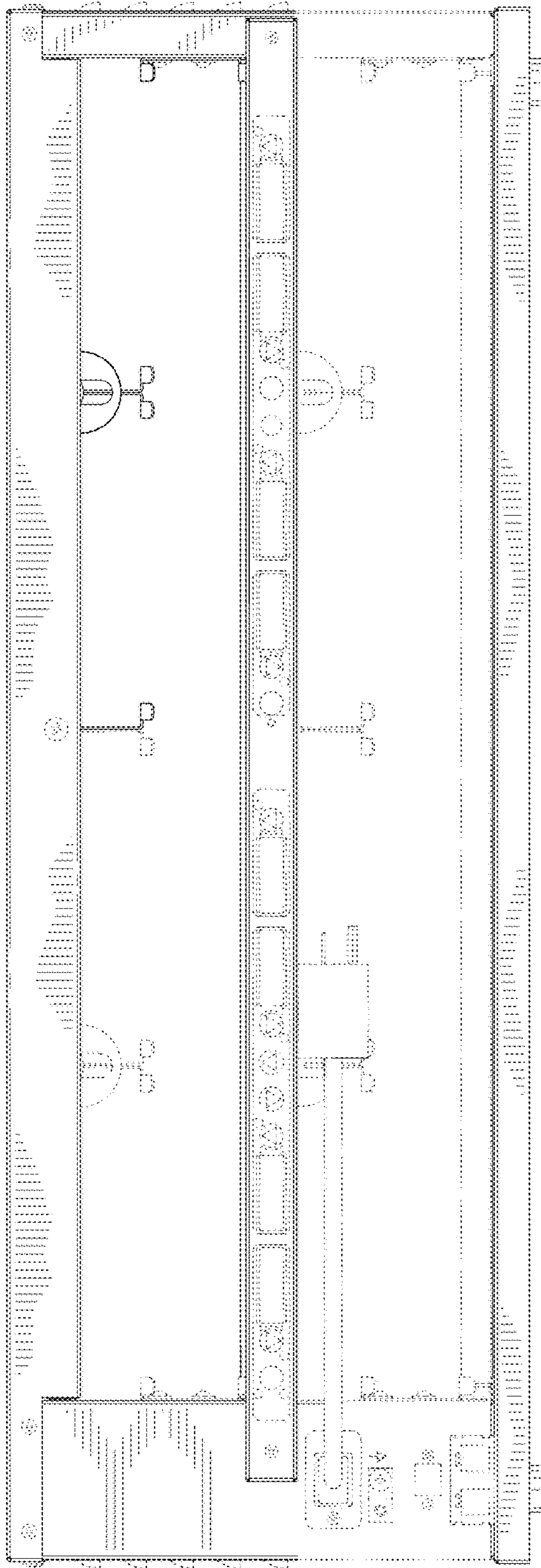

FIG. 31

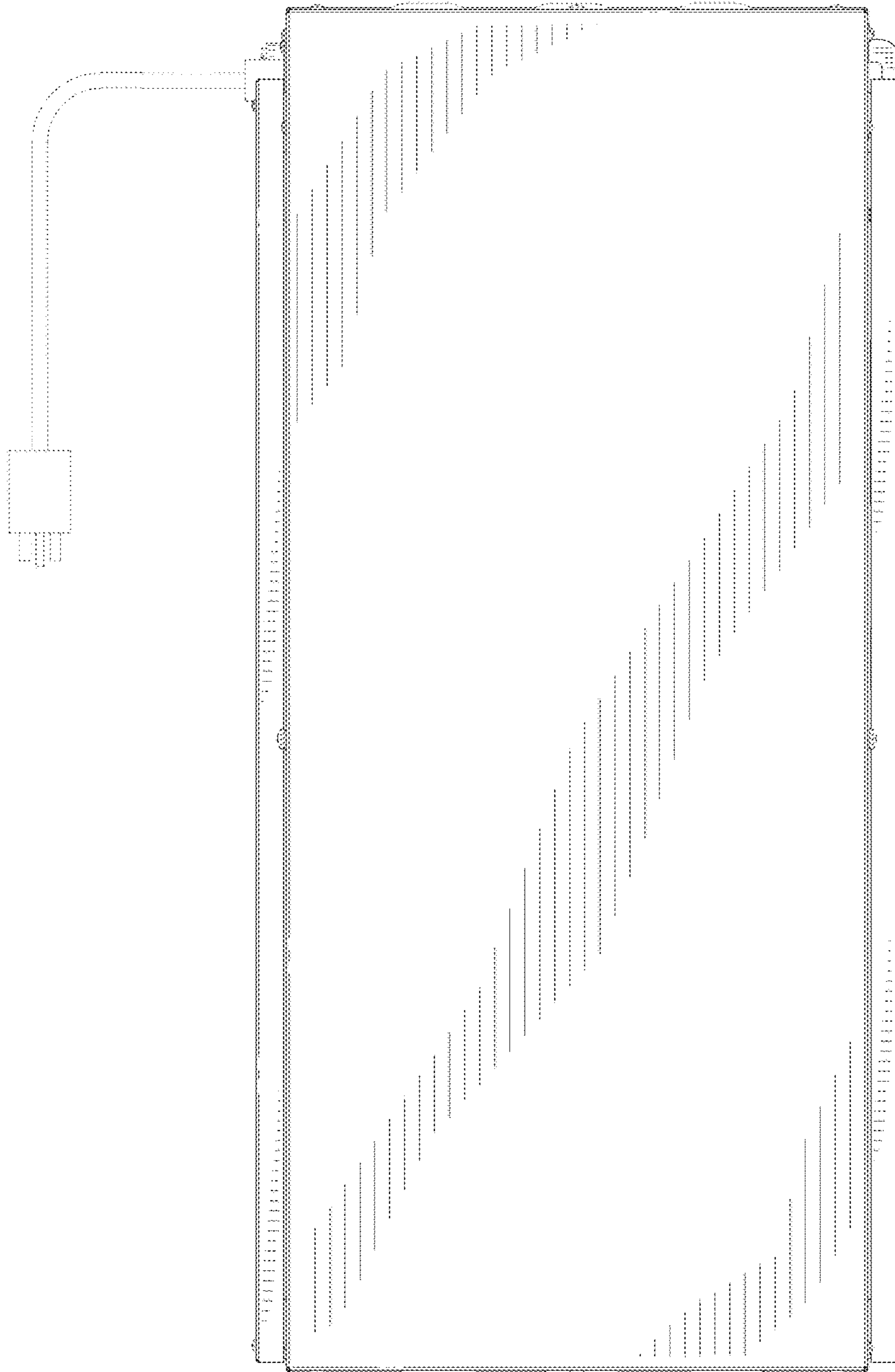

FIG. 32

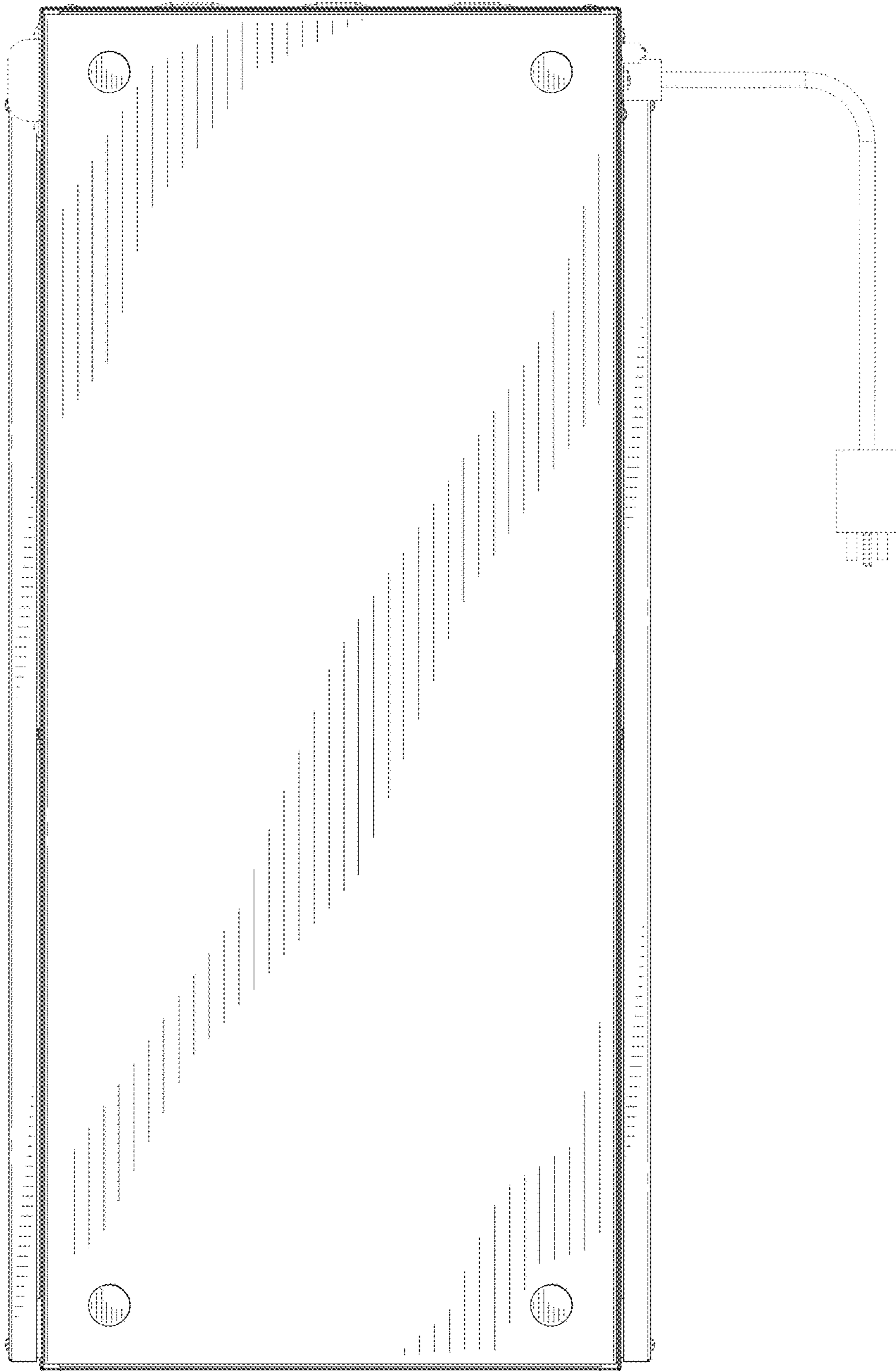

FIG. 33

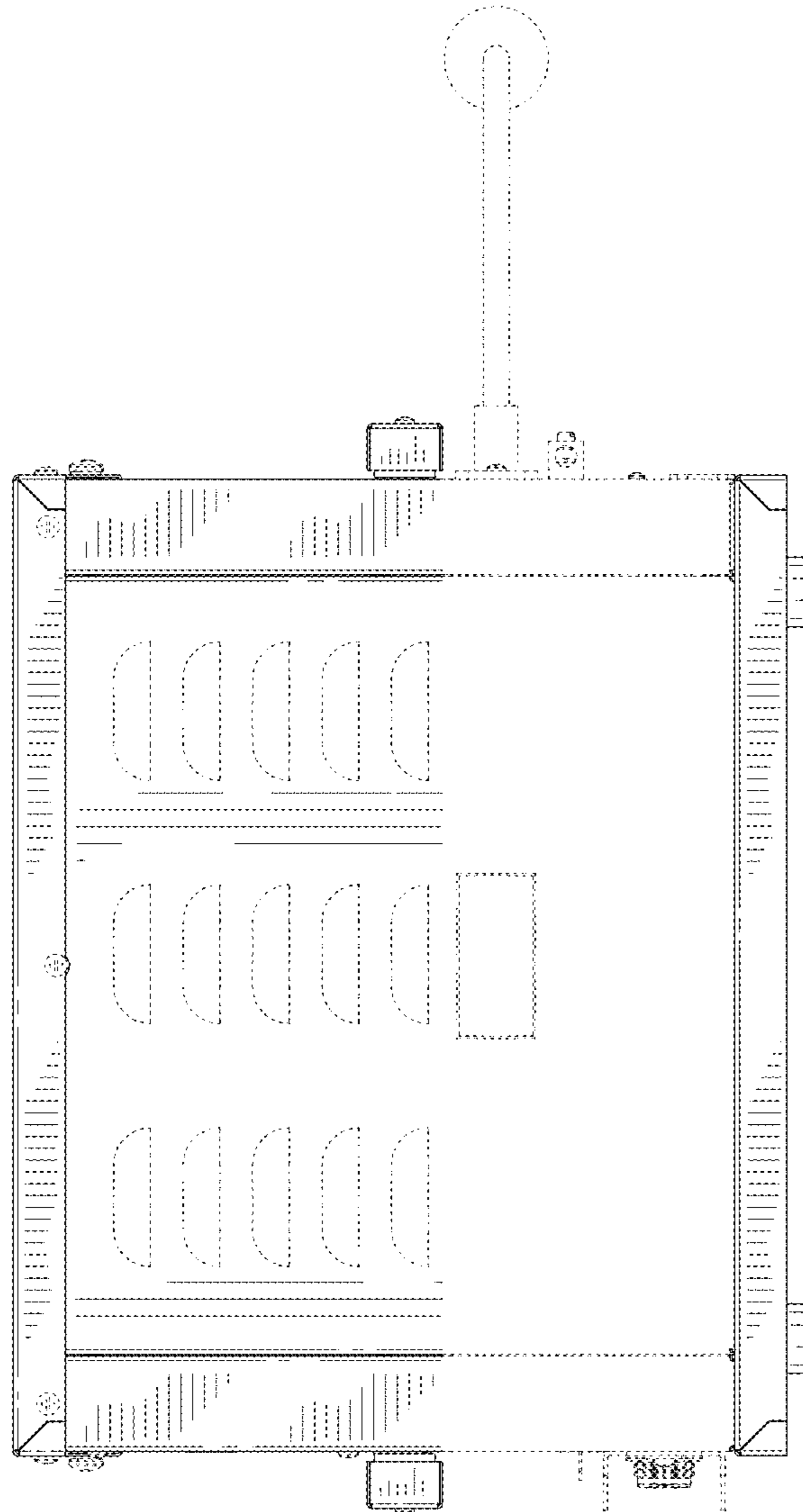

FIG. 34

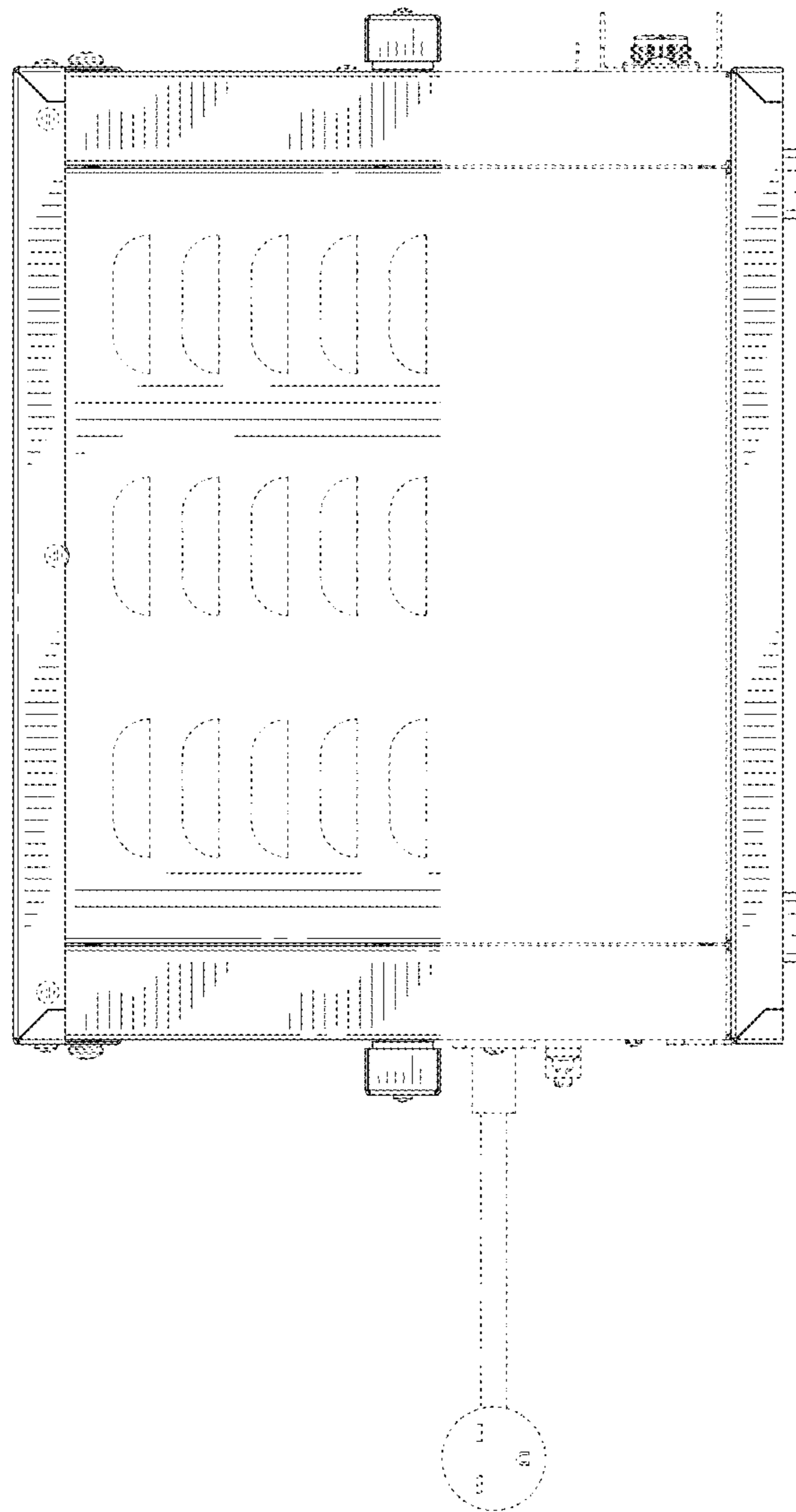

FIG. 35

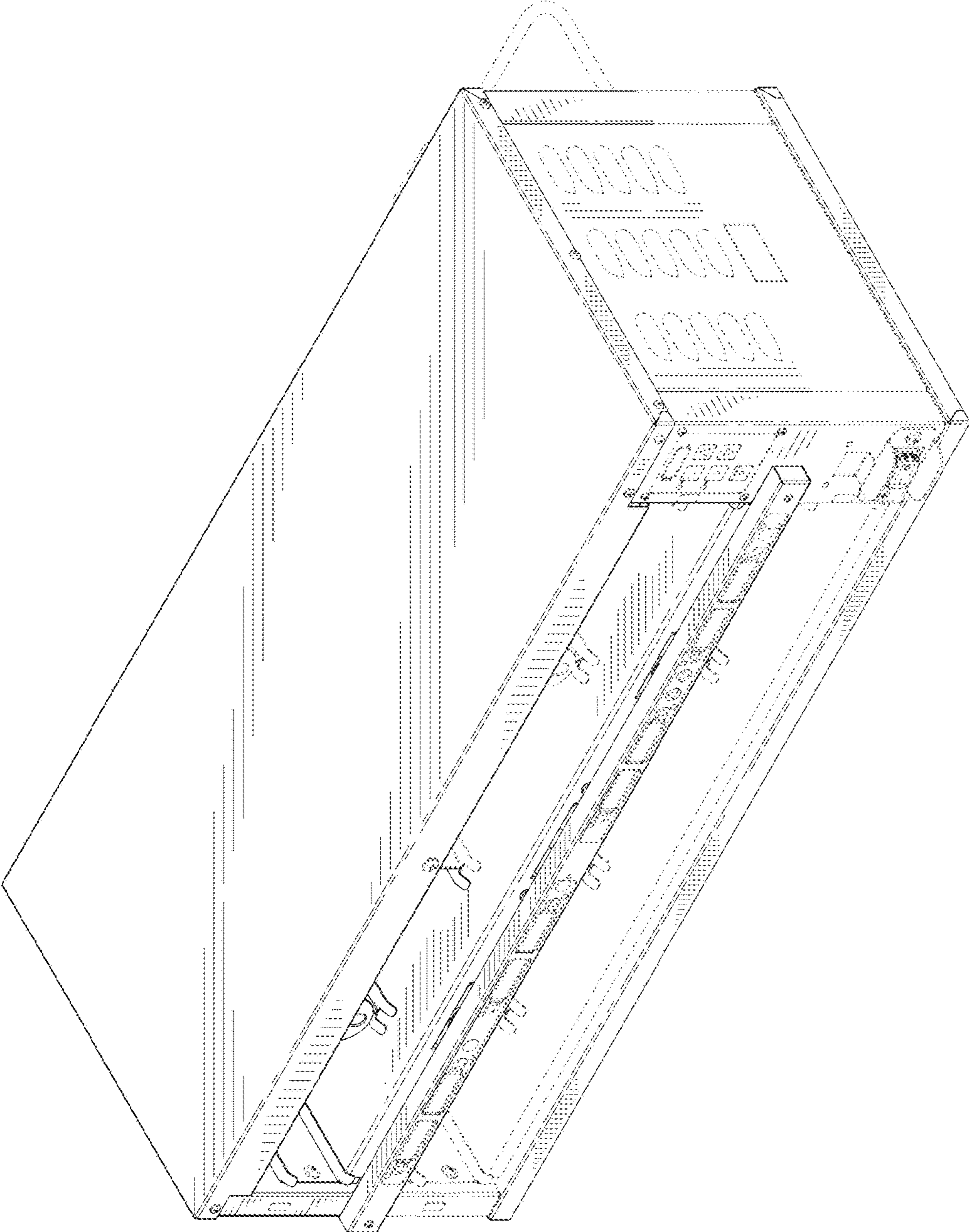

FIG. 36

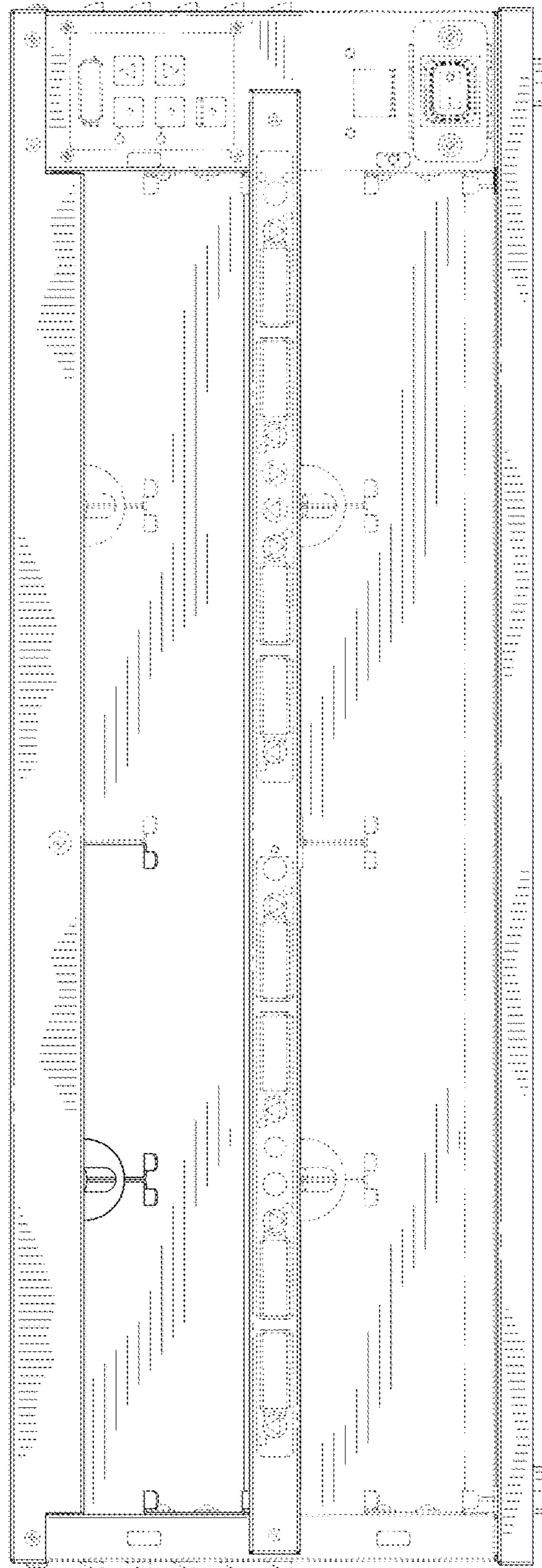

FIG. 37



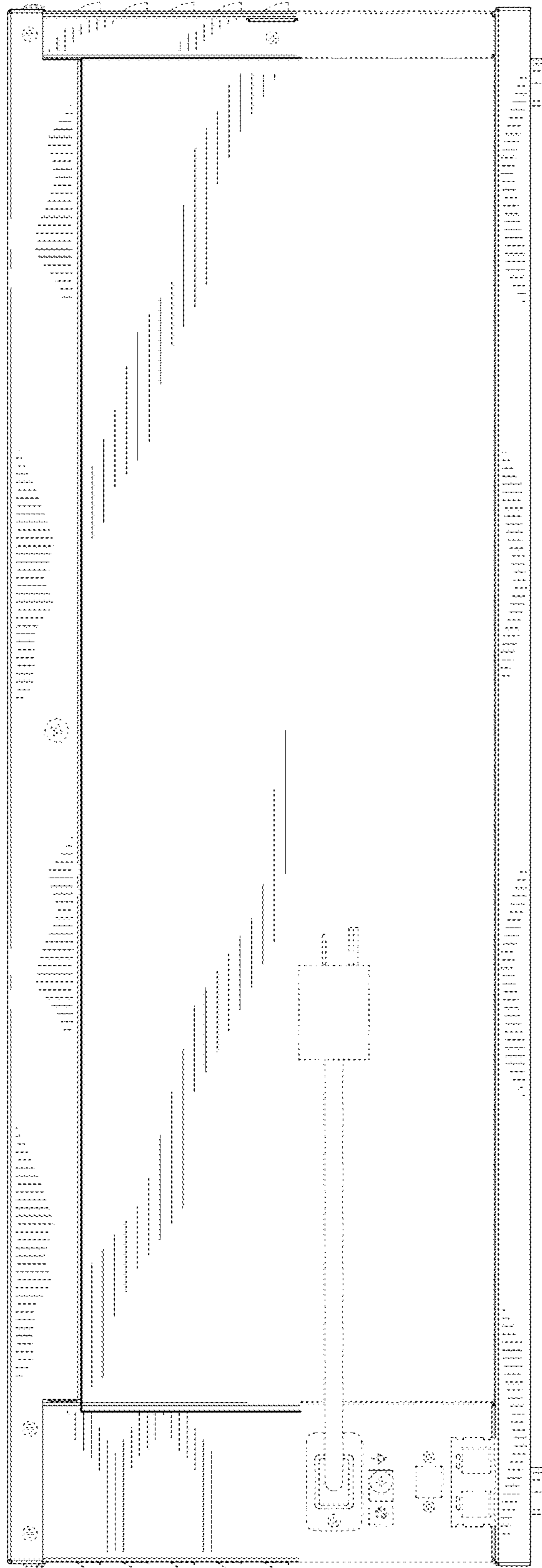

FIG. 38

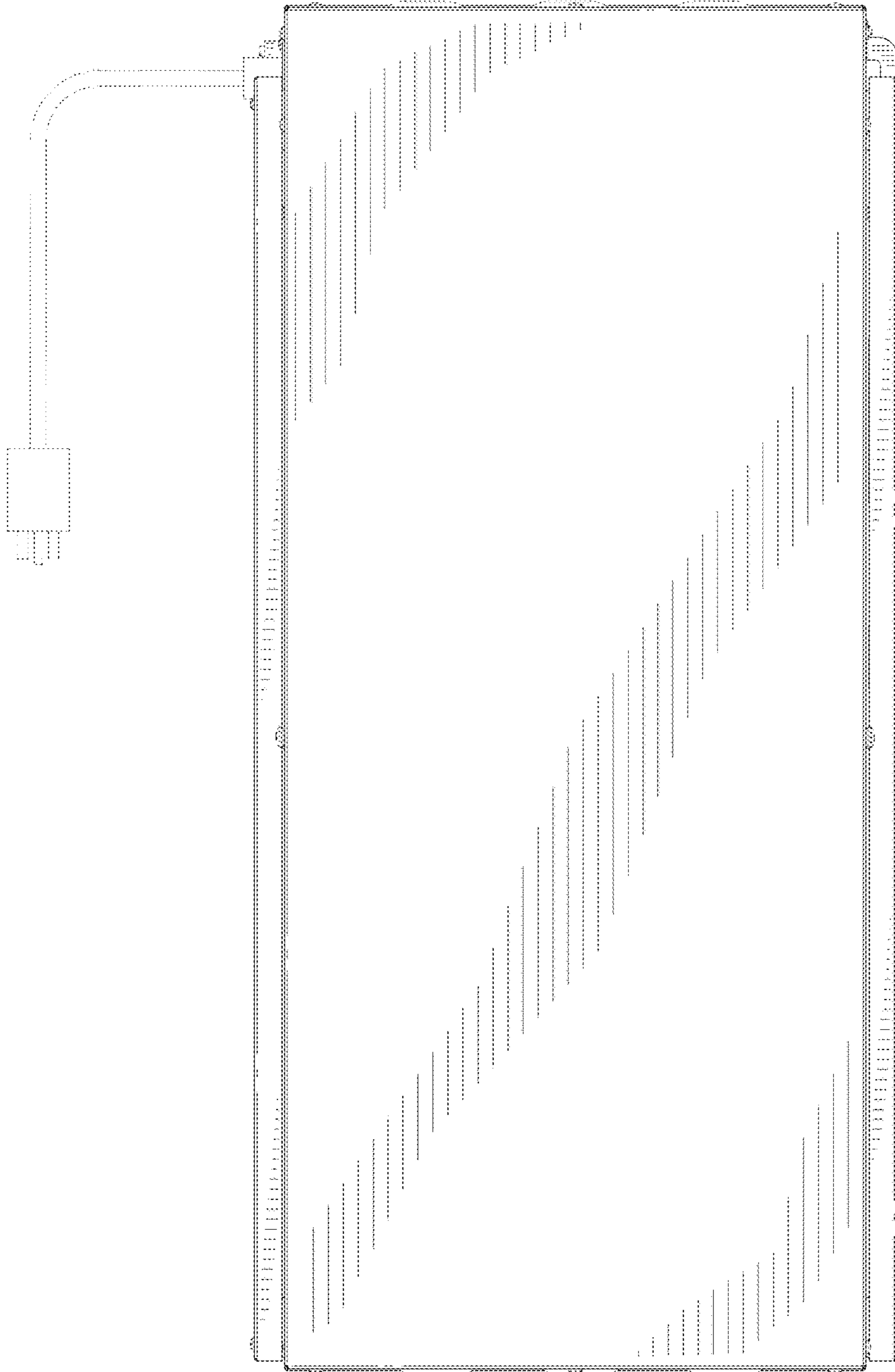

FIG. 39

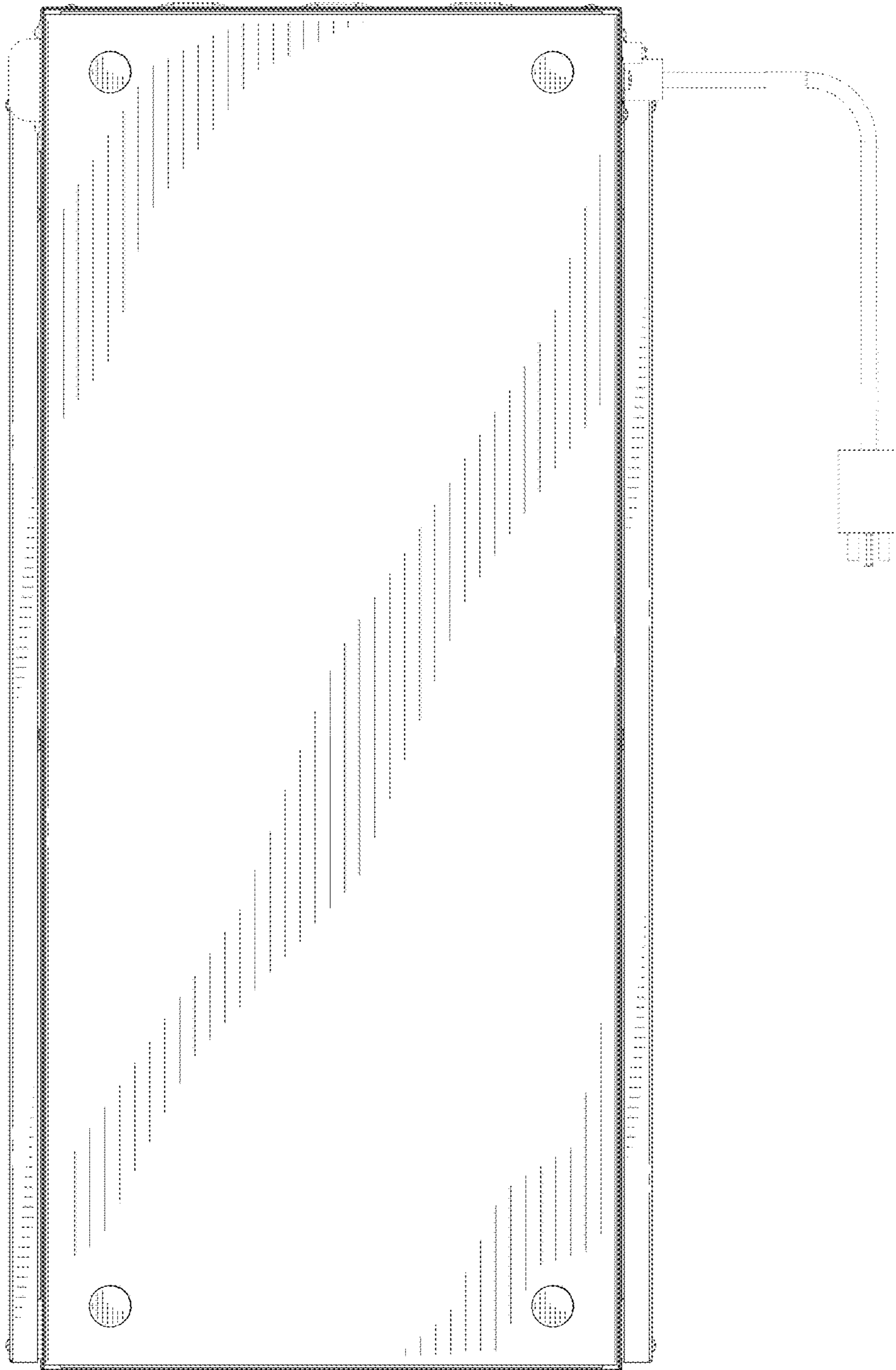

FIG. 40

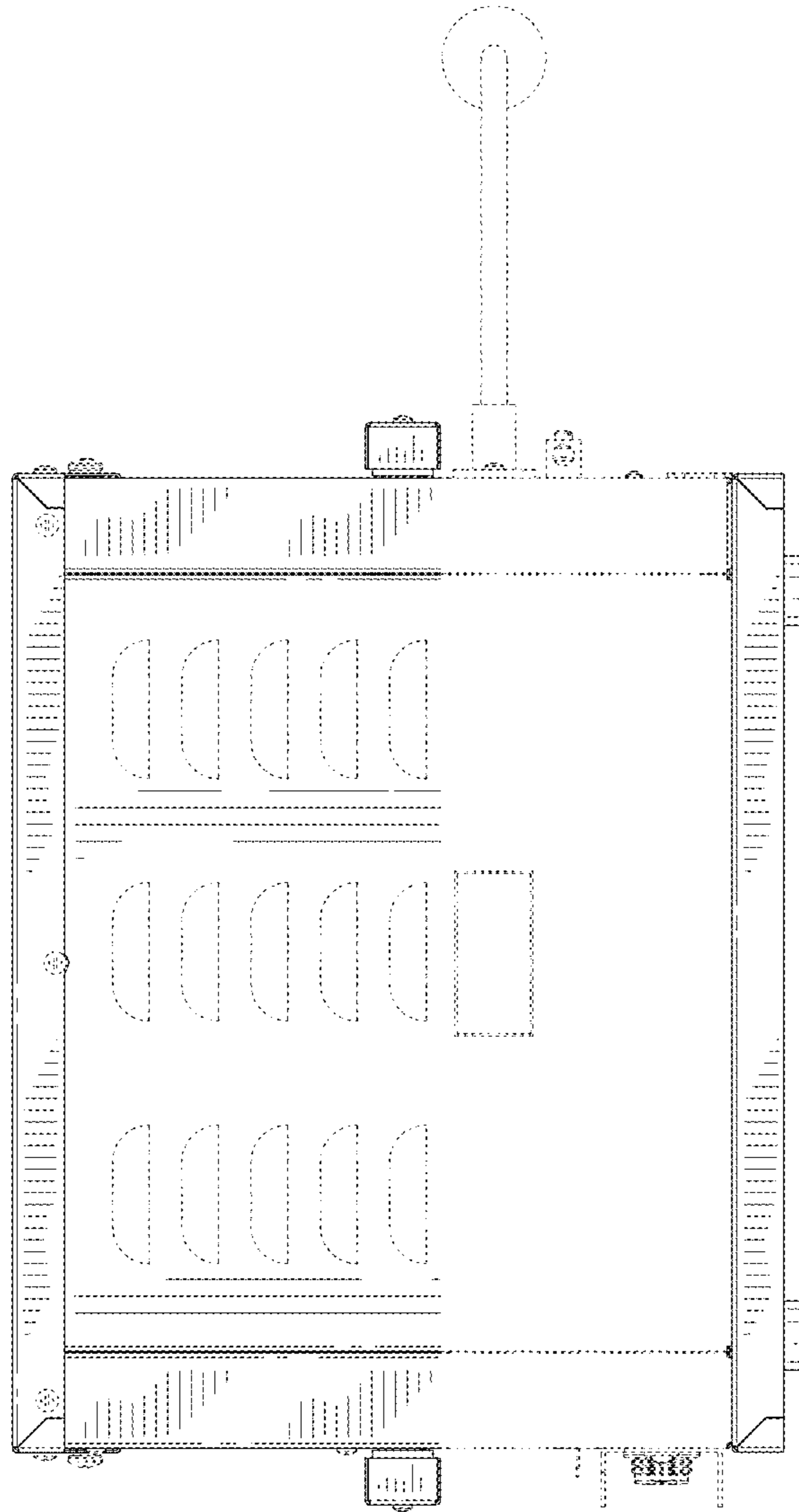

FIG. 41

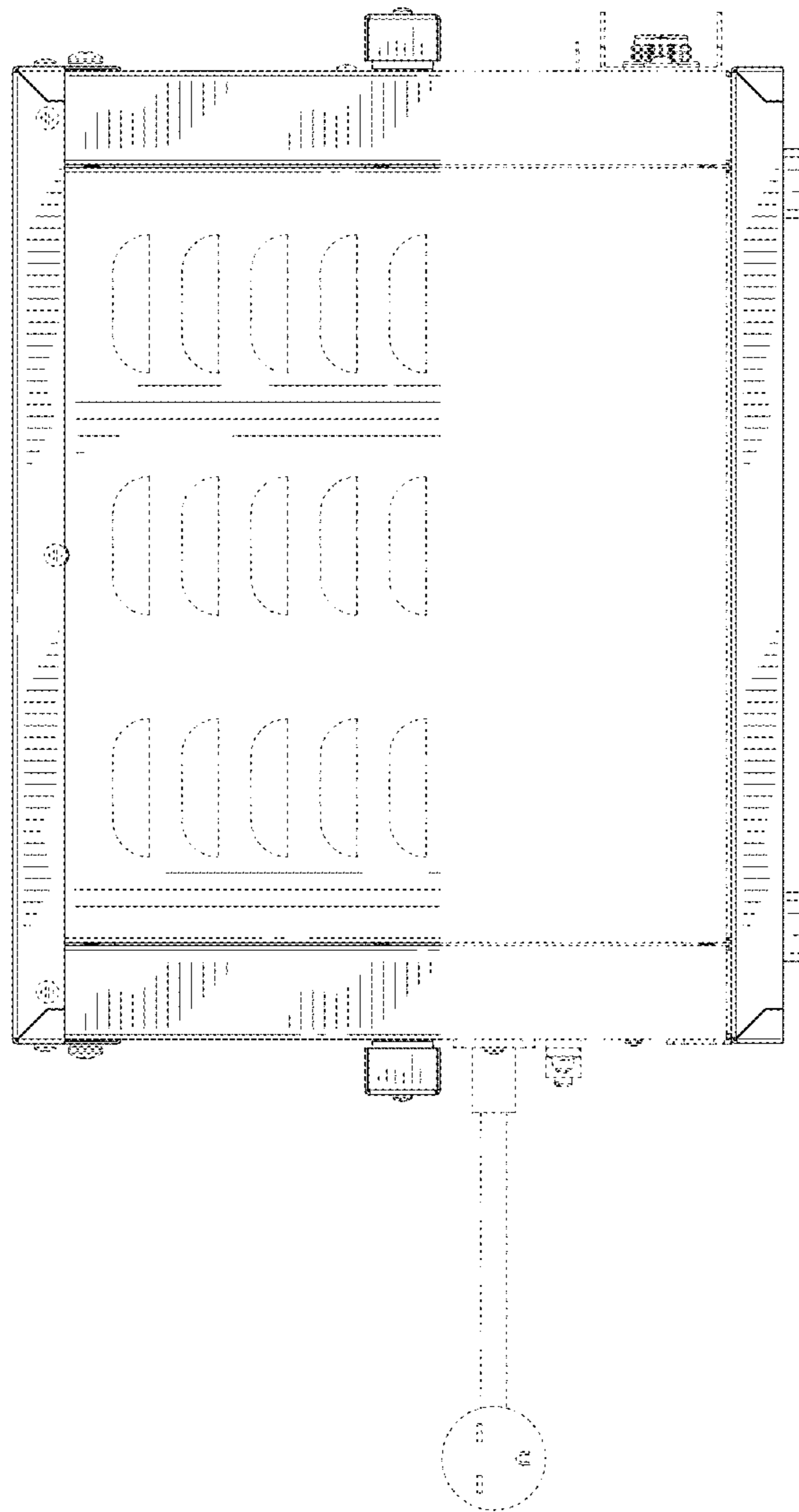

FIG. 42

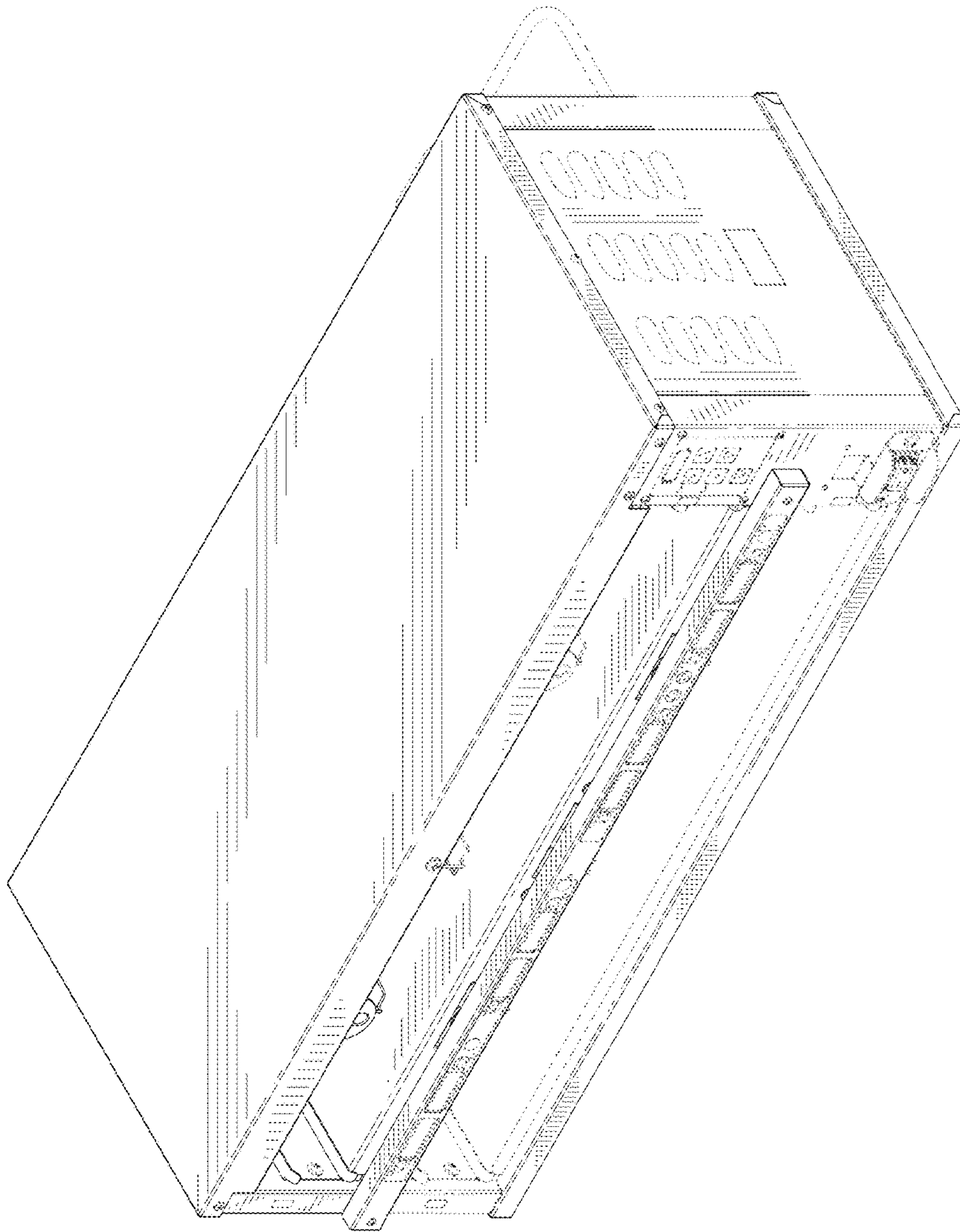

FIG. 43

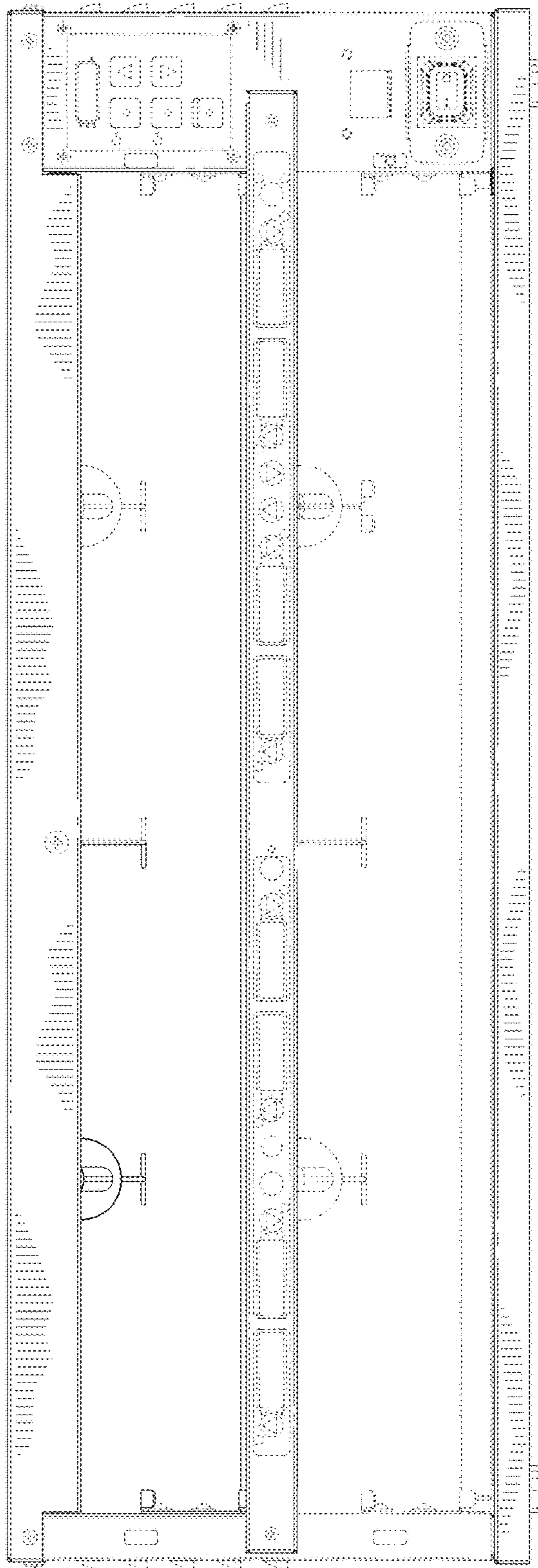

FIG. 44

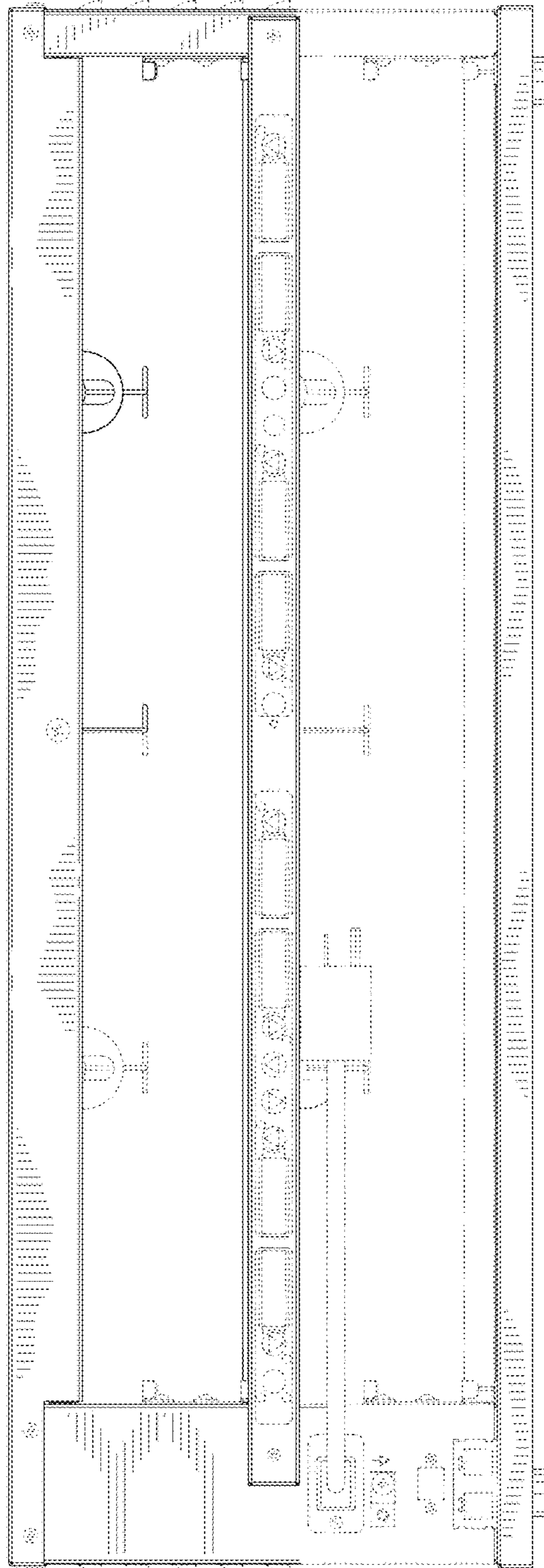

FIG. 45



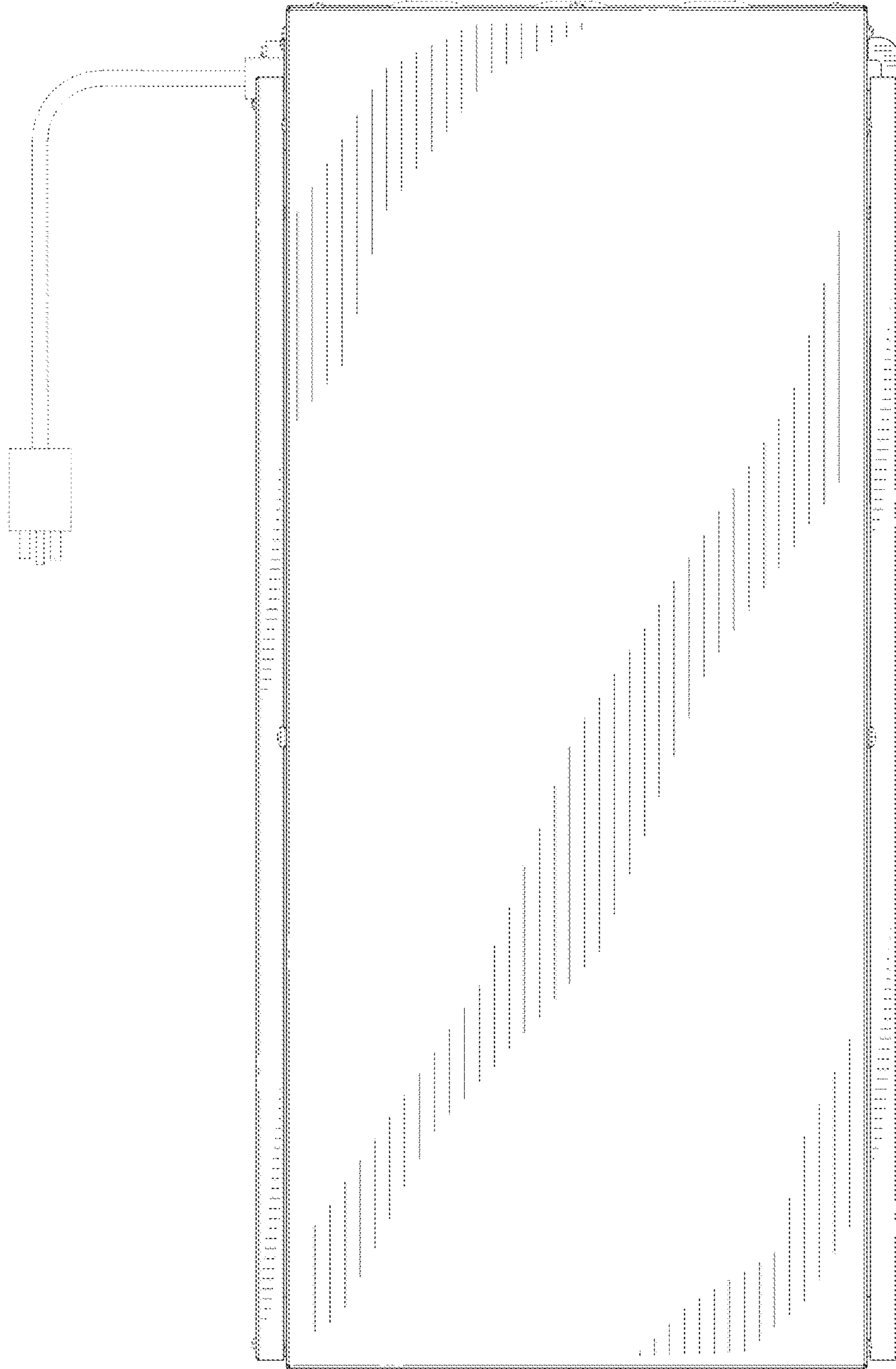

FIG. 46

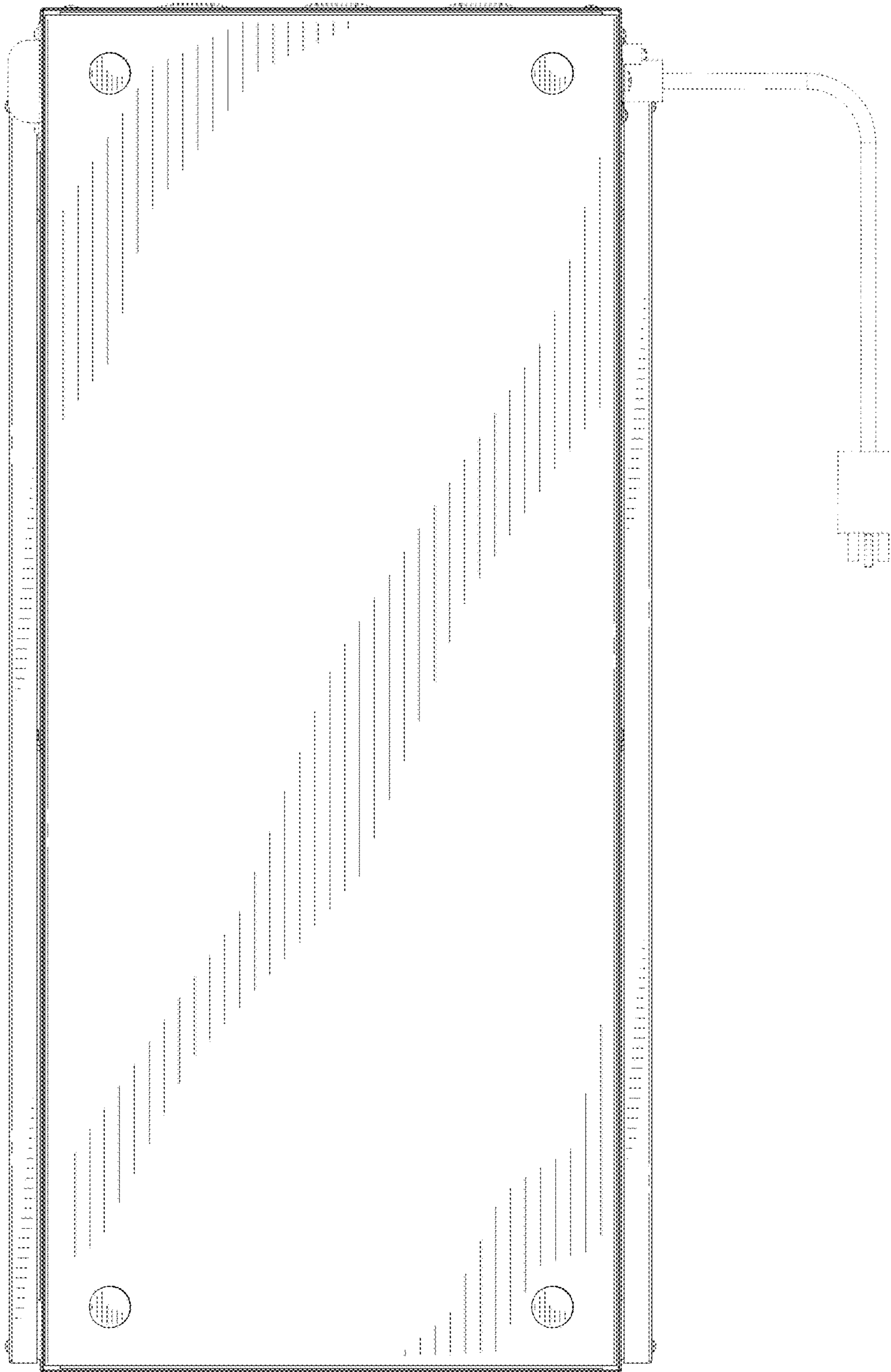

FIG. 47

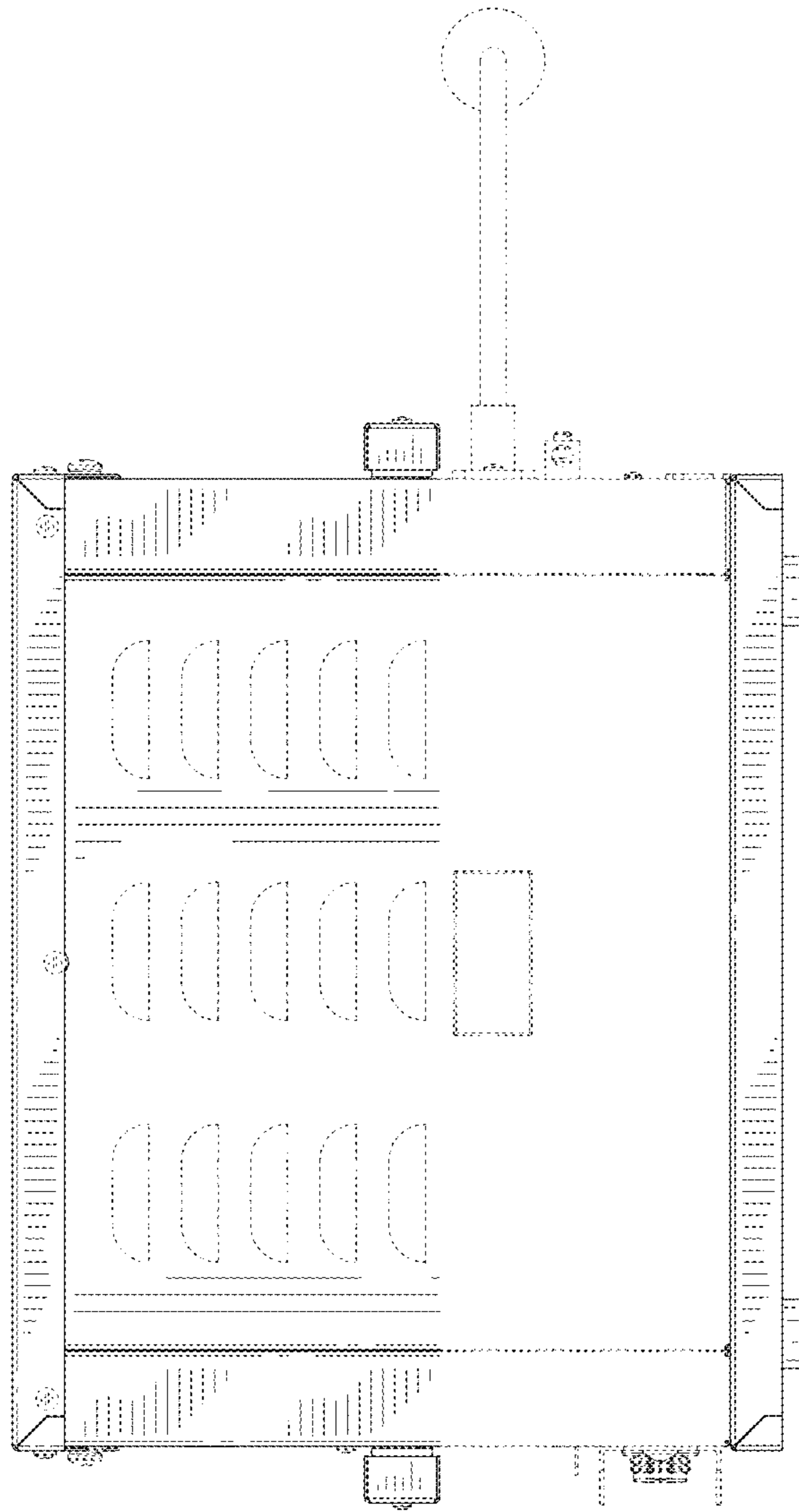

FIG. 48

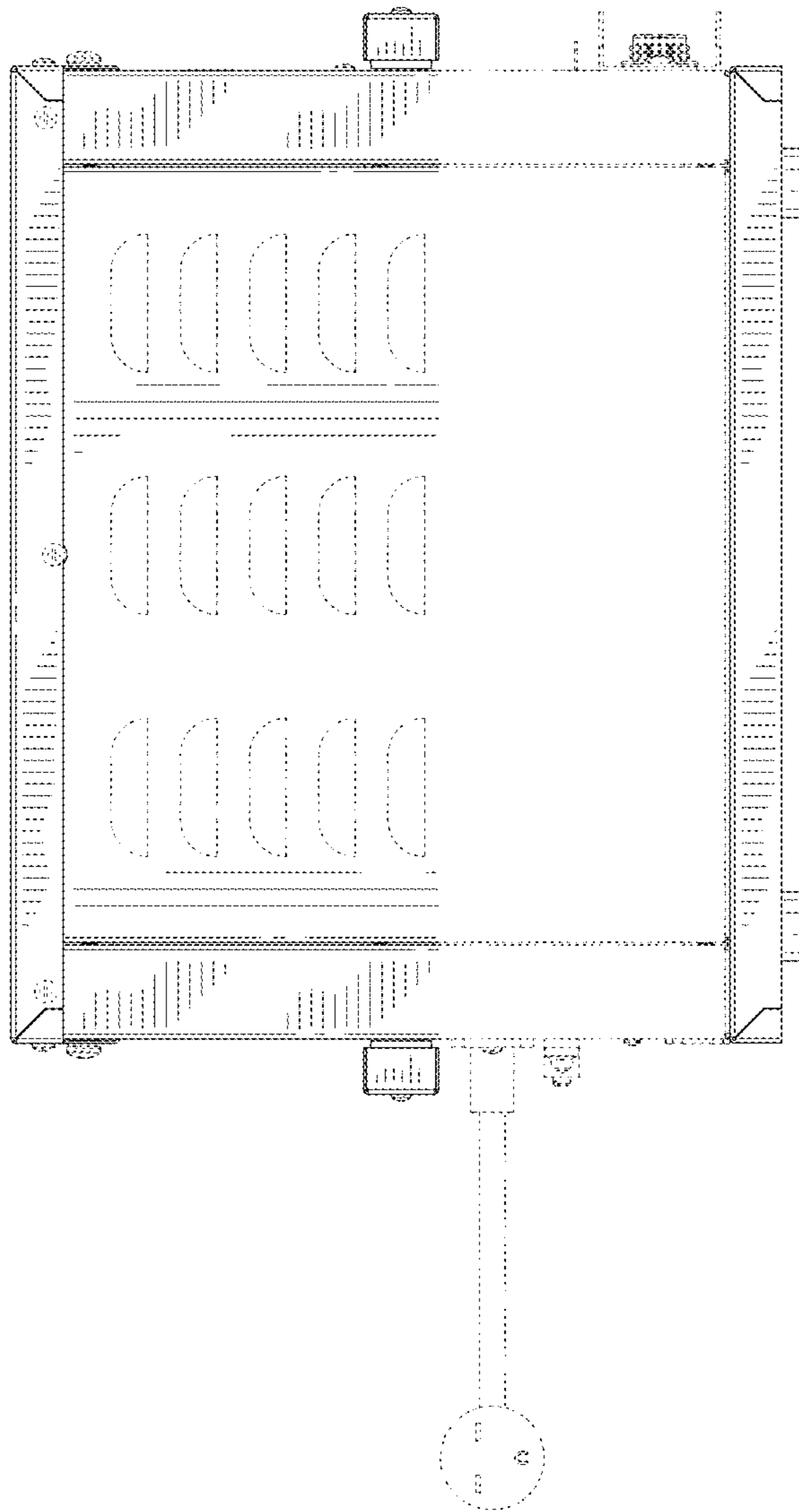

FIG. 49

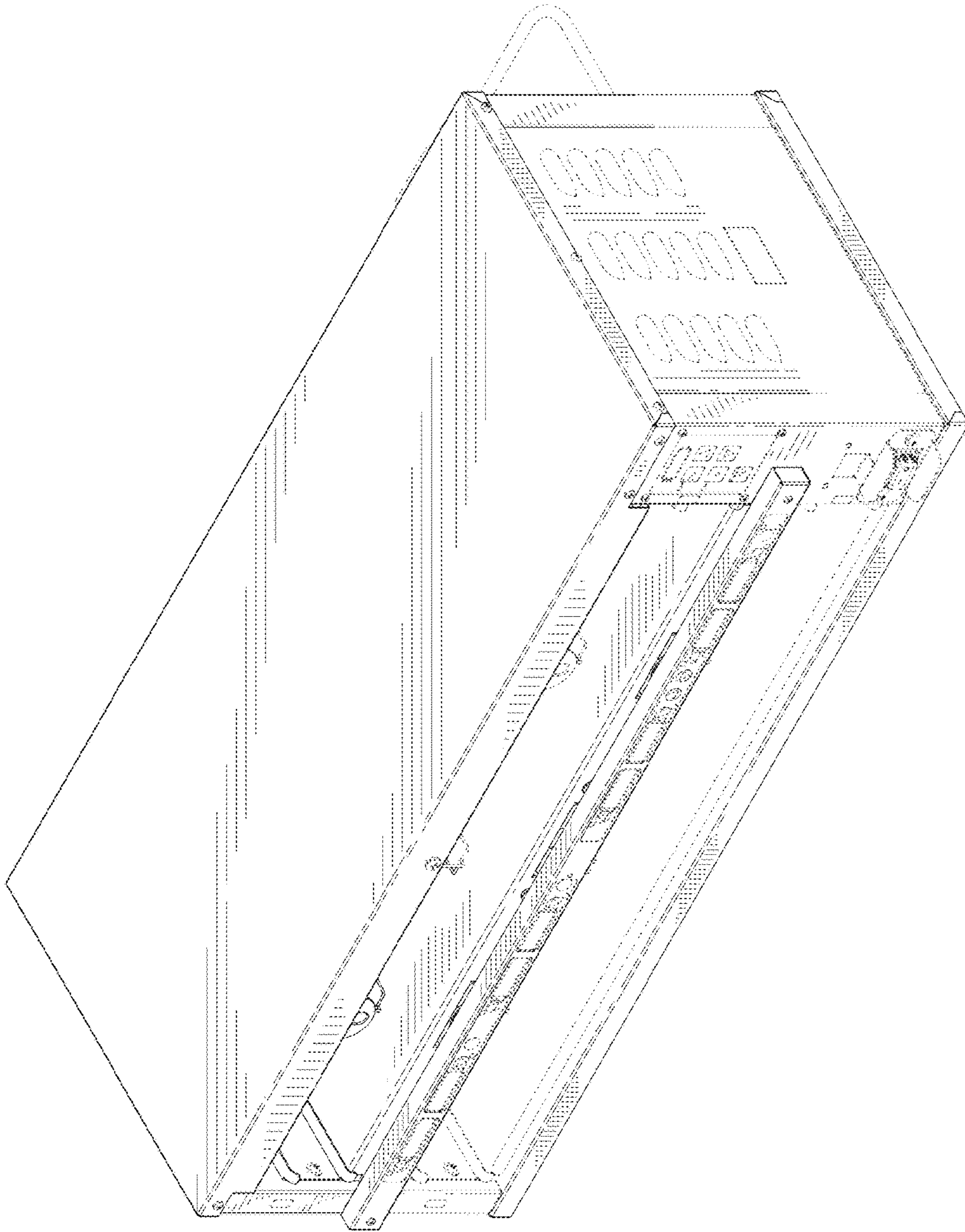

FIG. 50

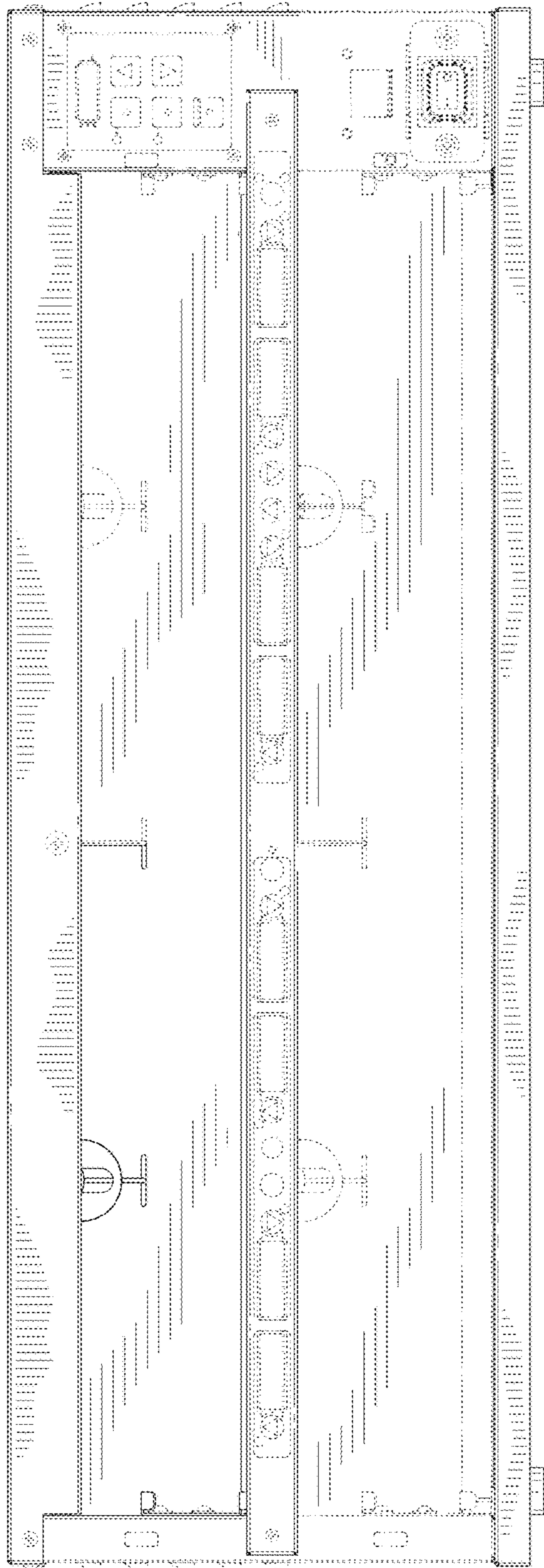

FIG. 51

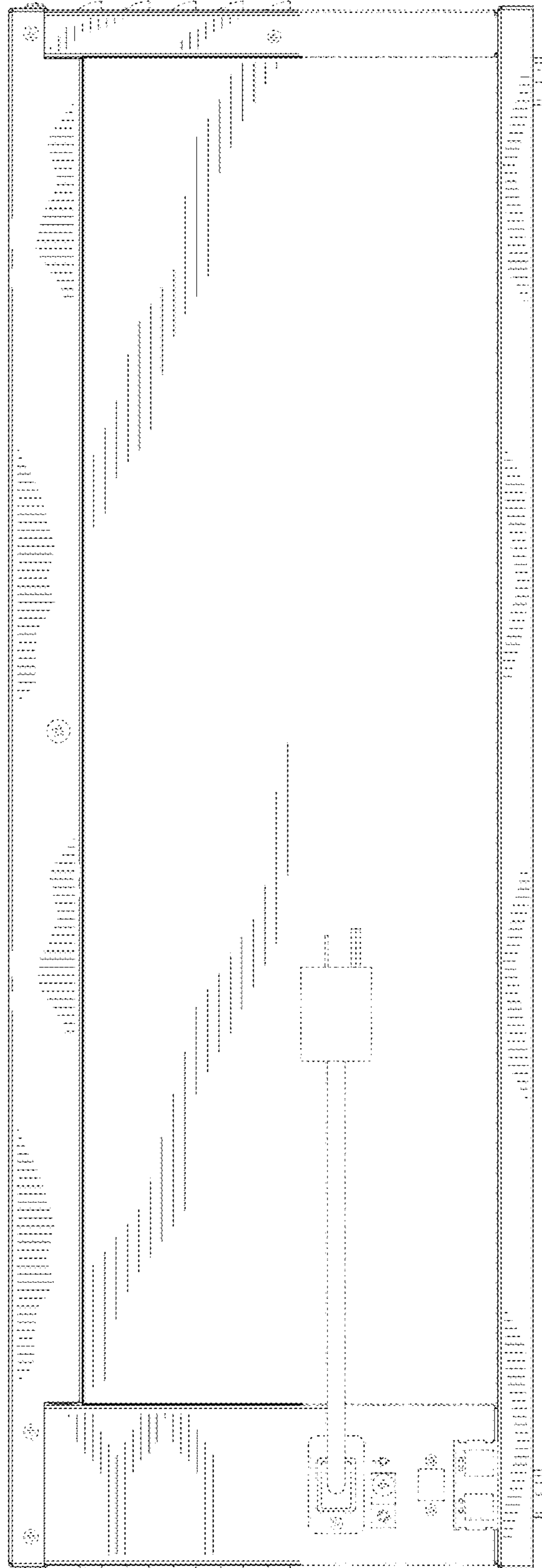

FIG. 52

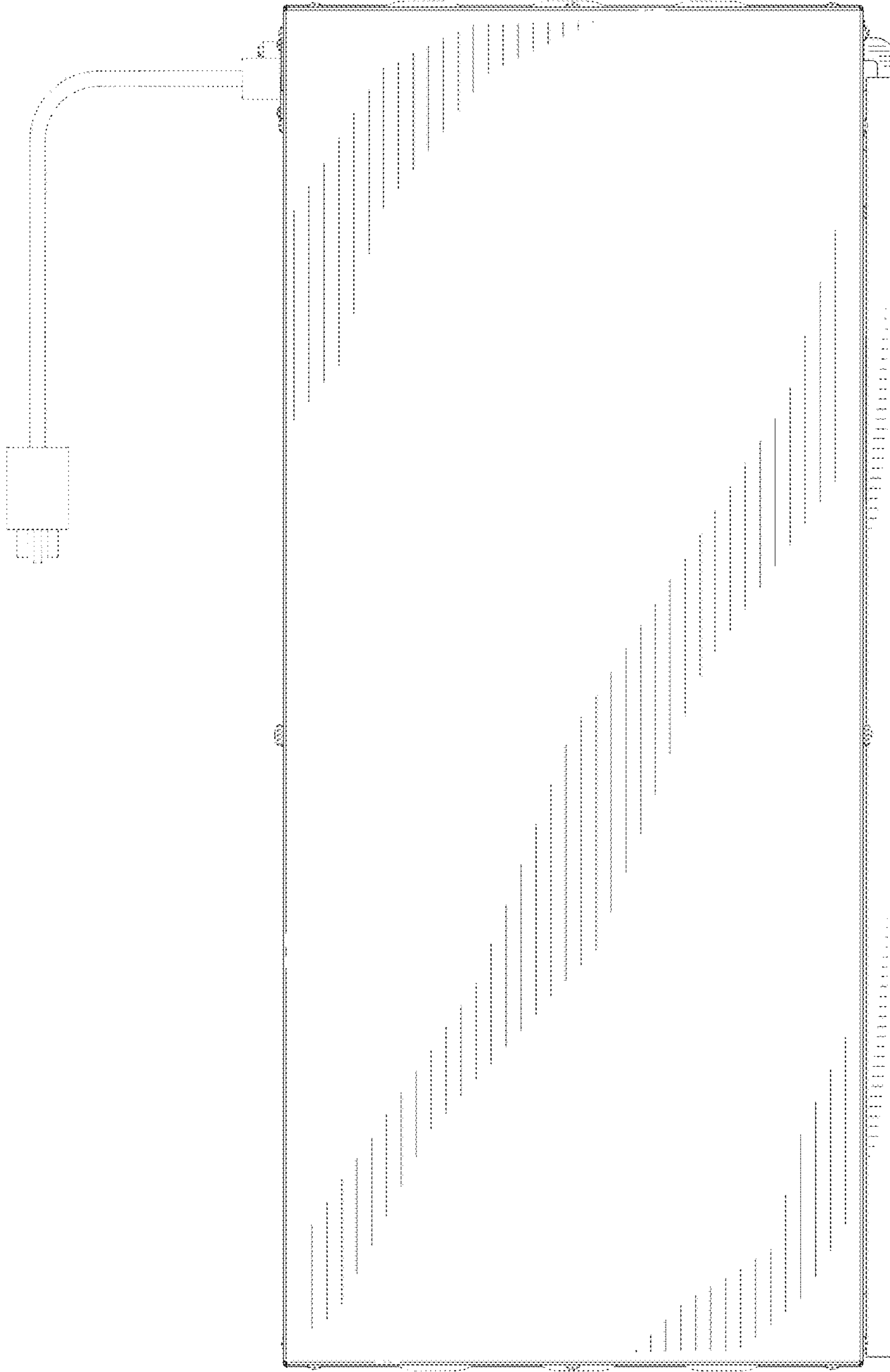

FIG. 53



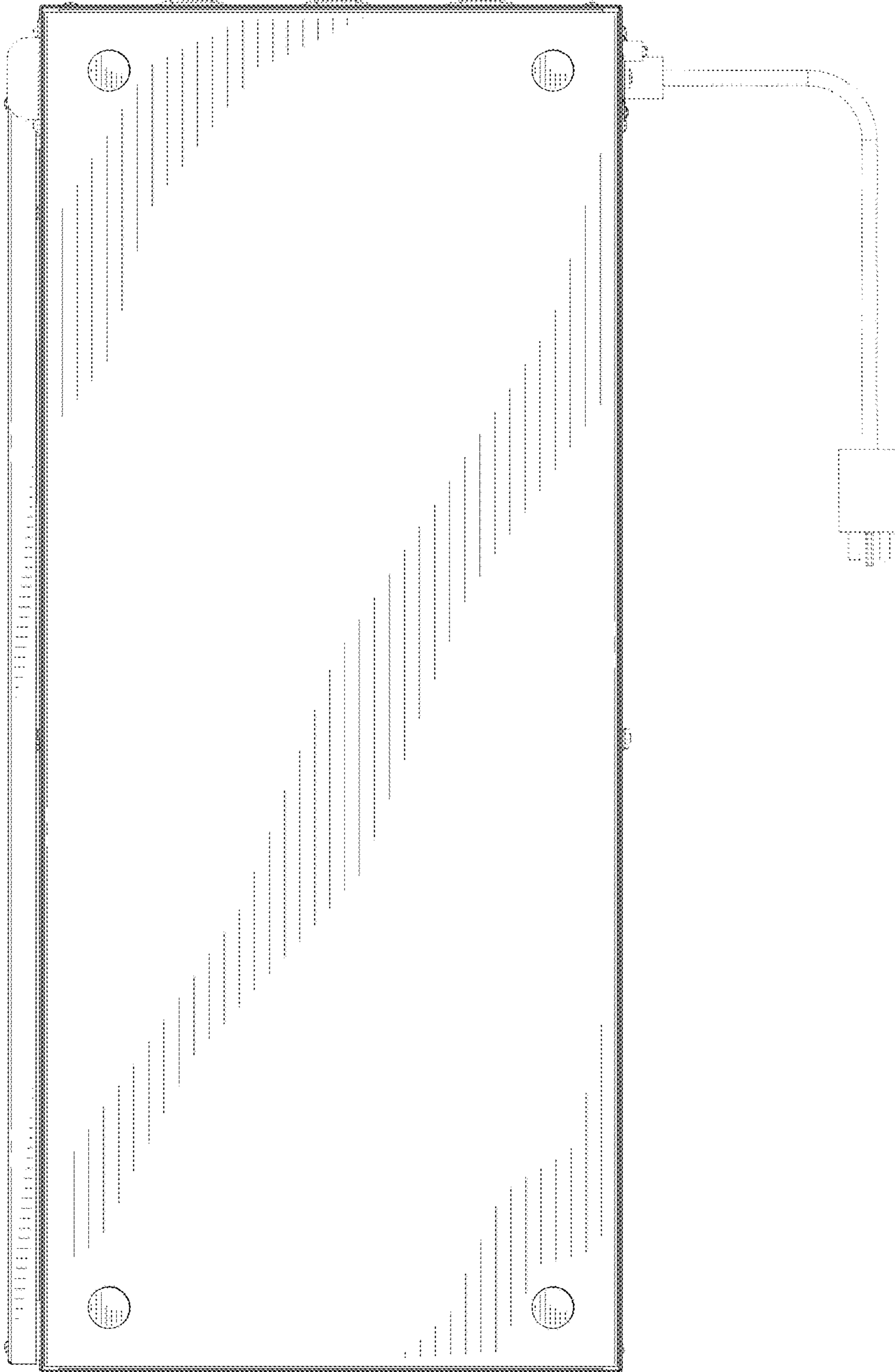

FIG. 54

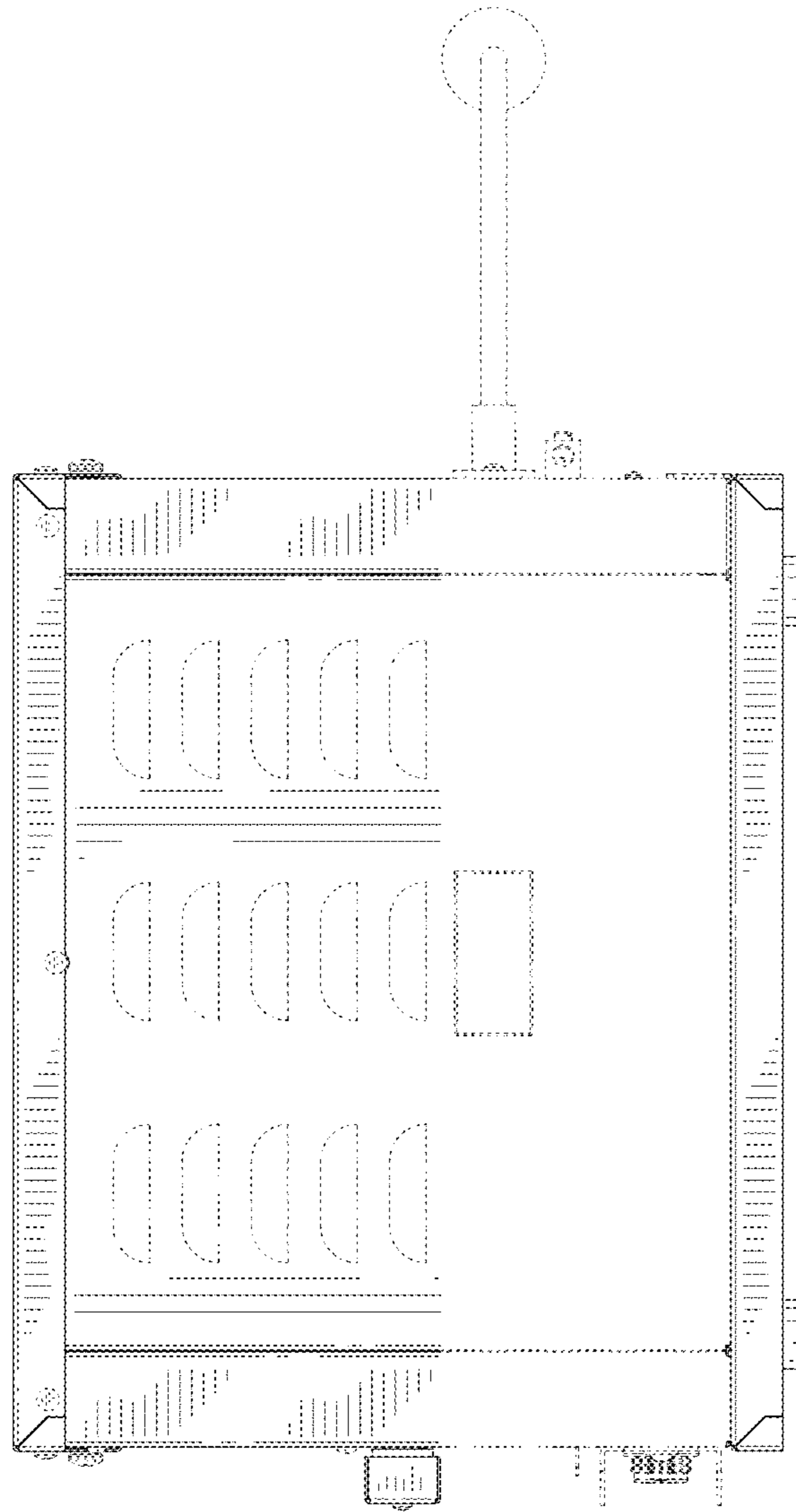

FIG. 55

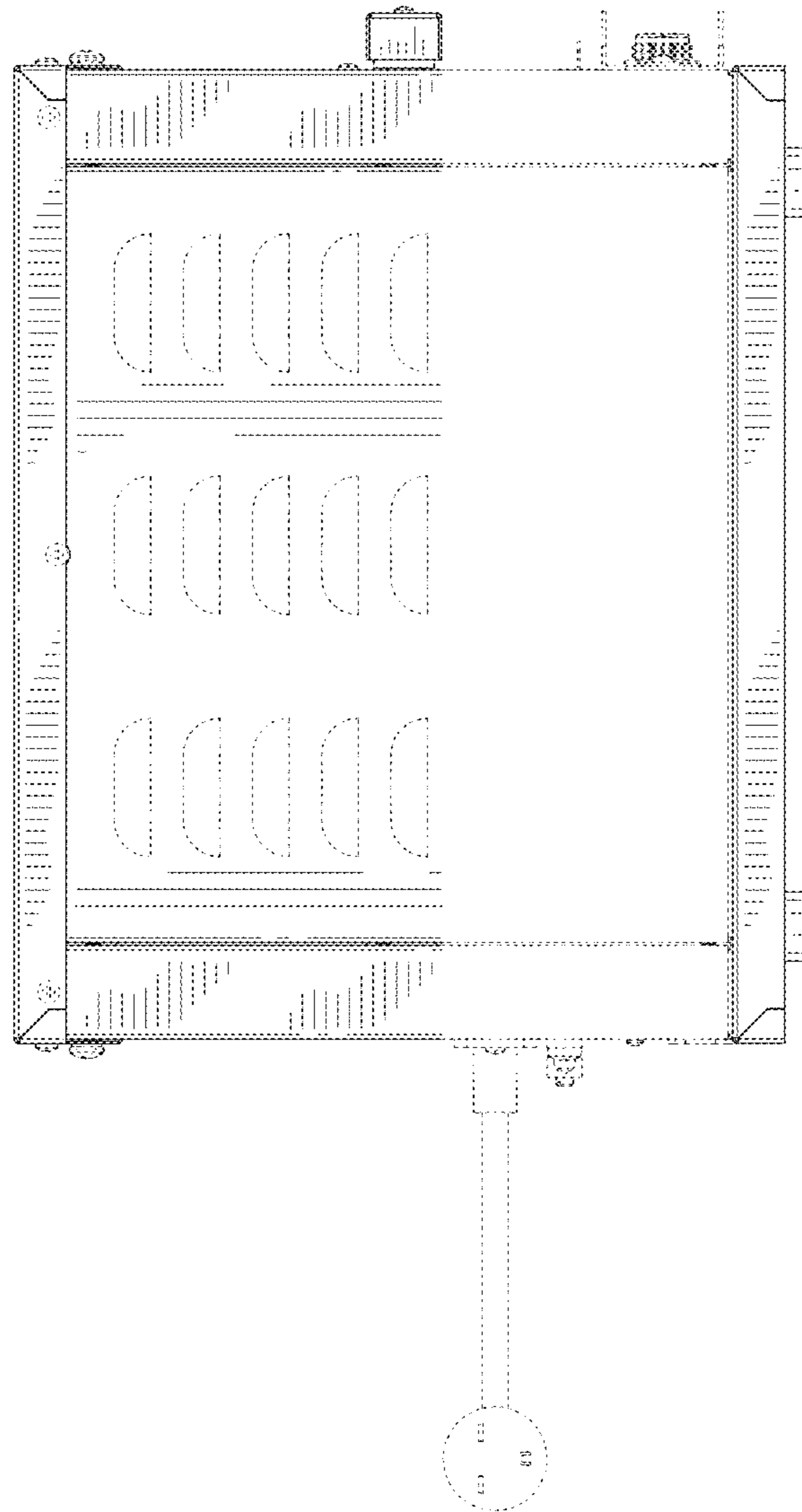

FIG. 56

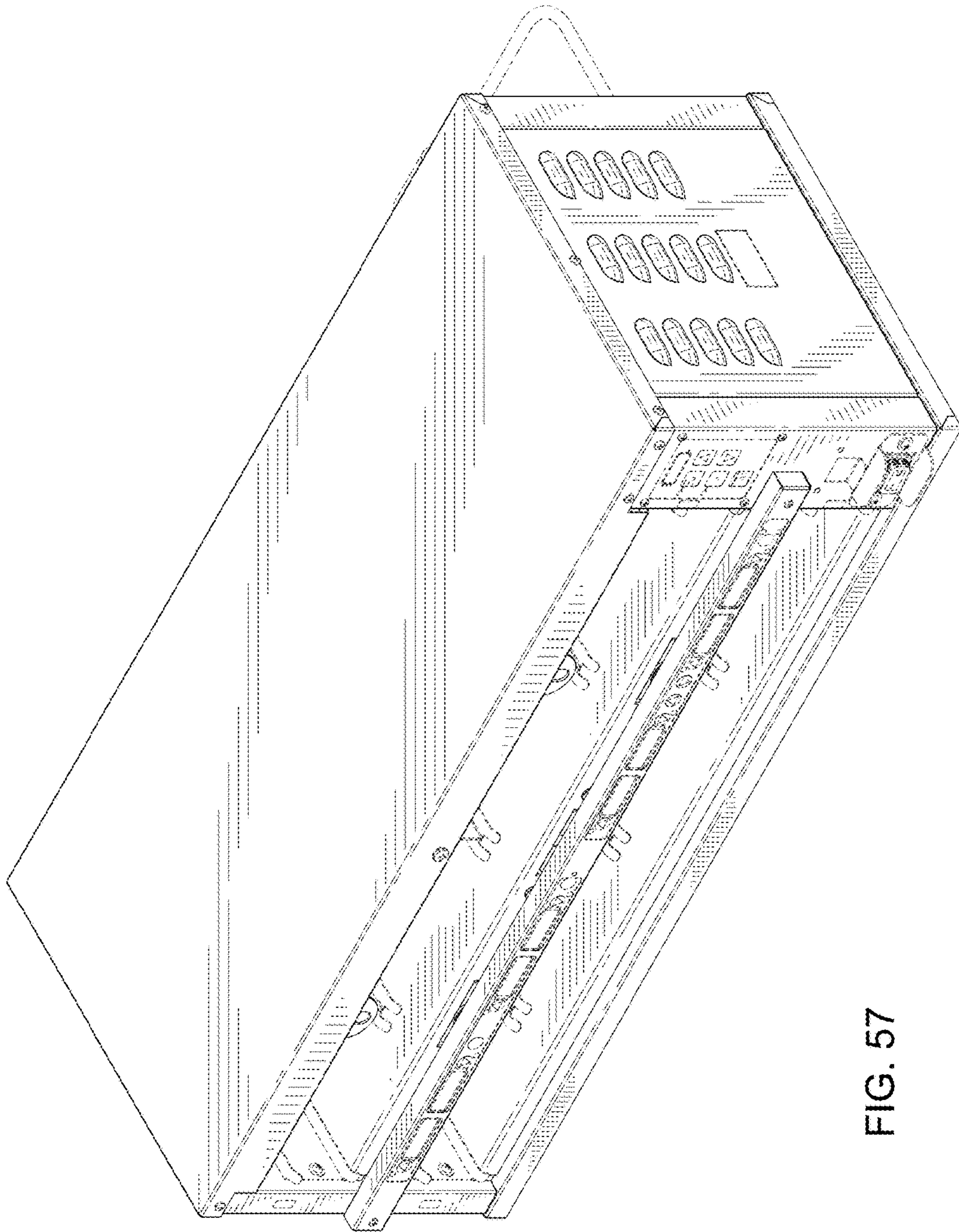

FIG. 57

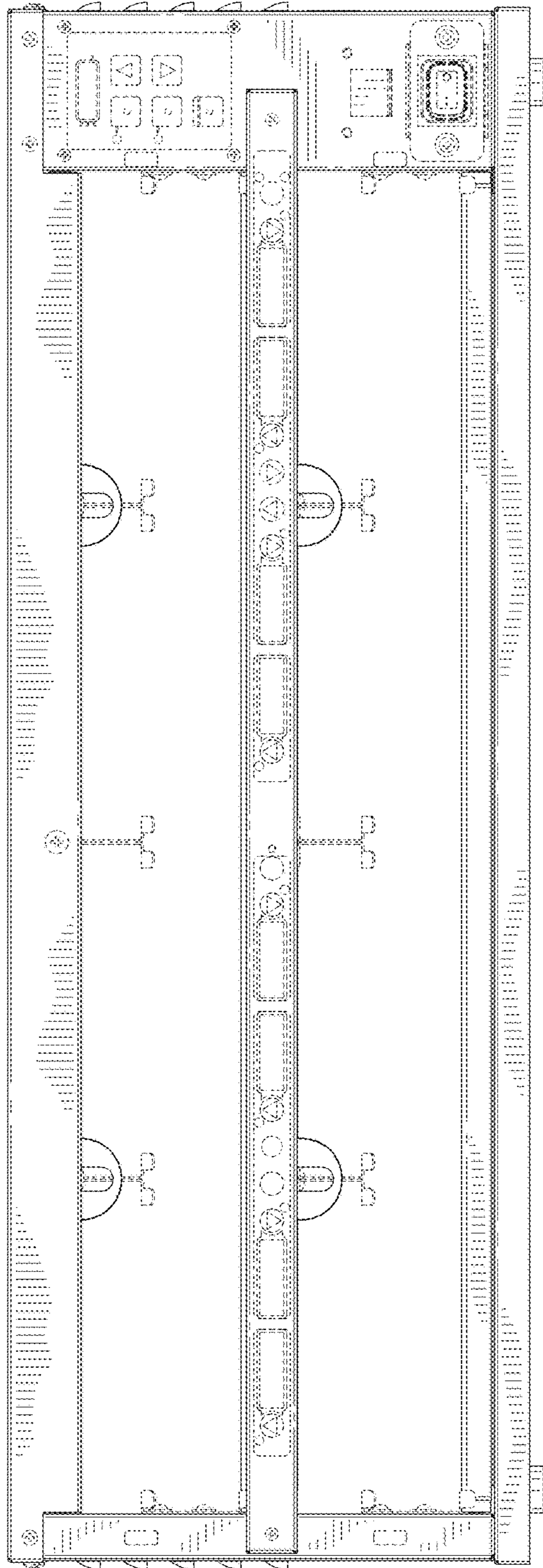

FIG. 58

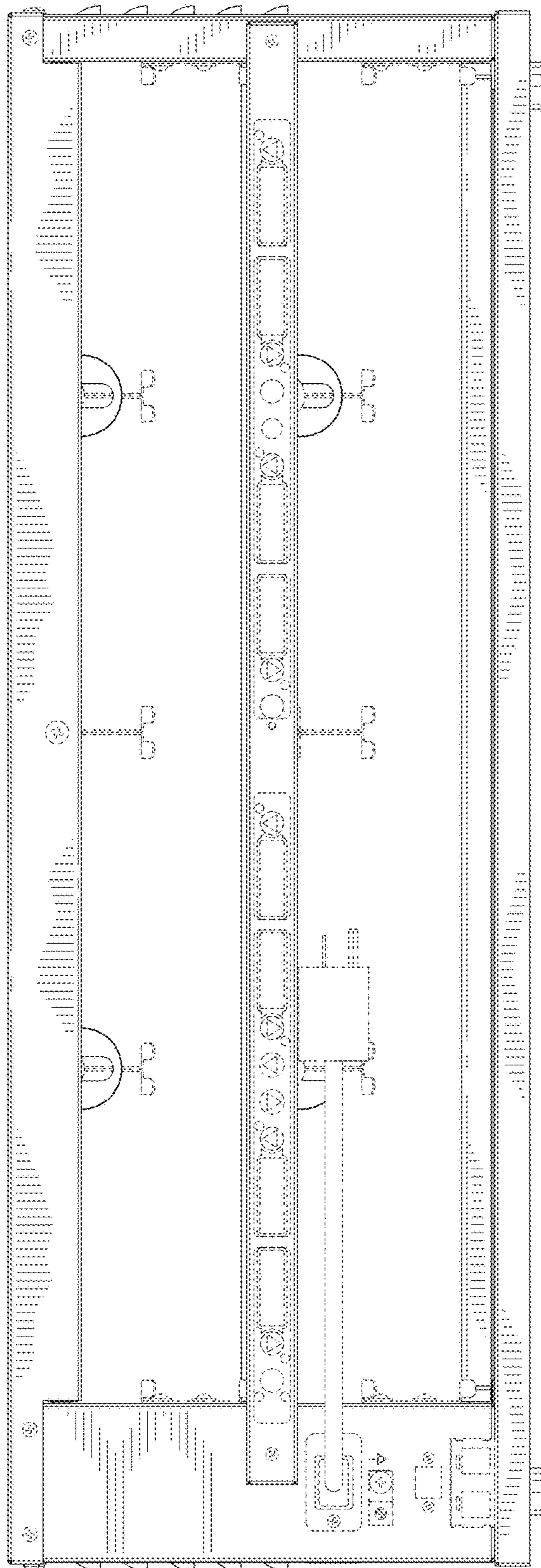

FIG. 59

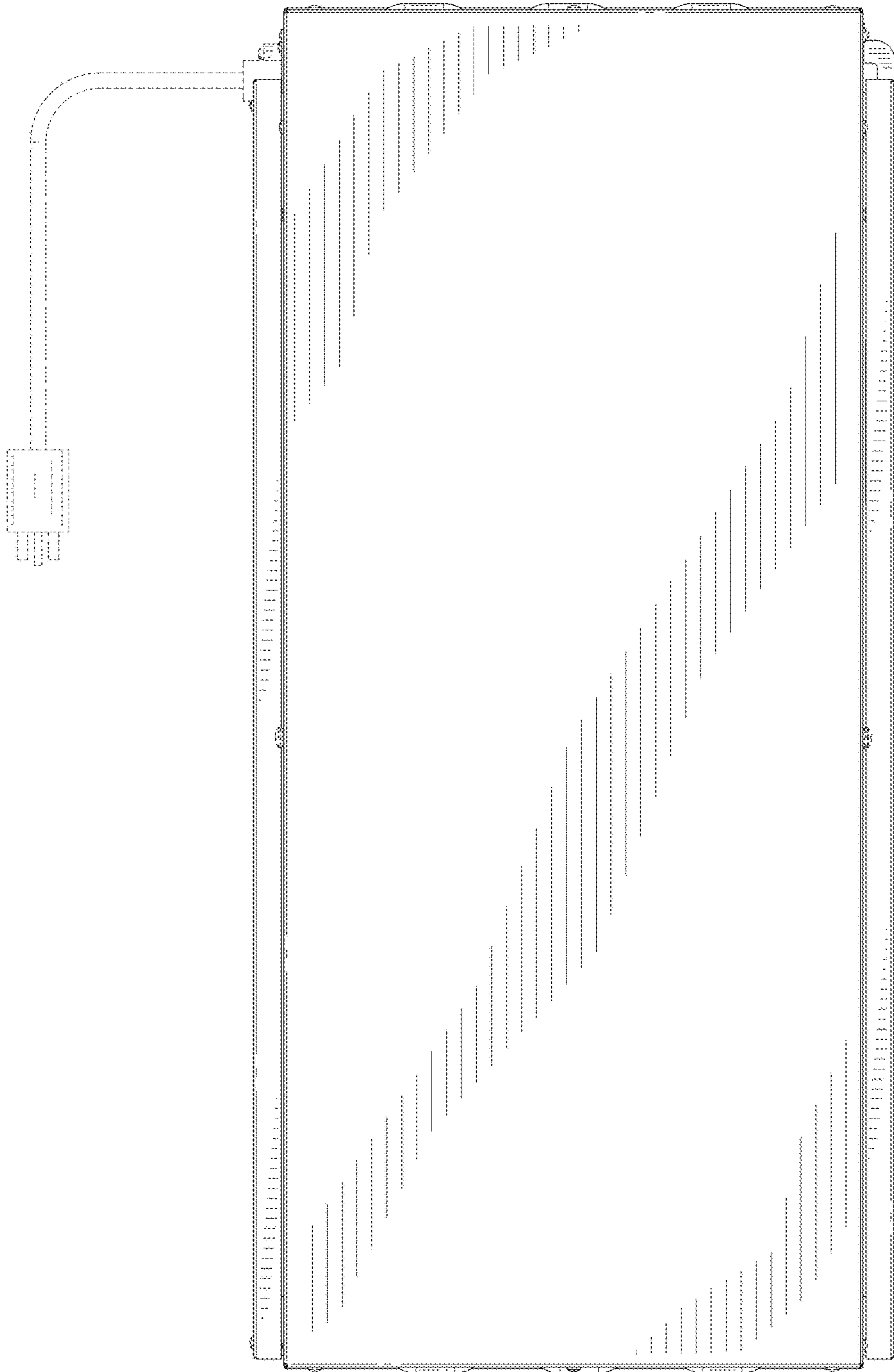

FIG. 60

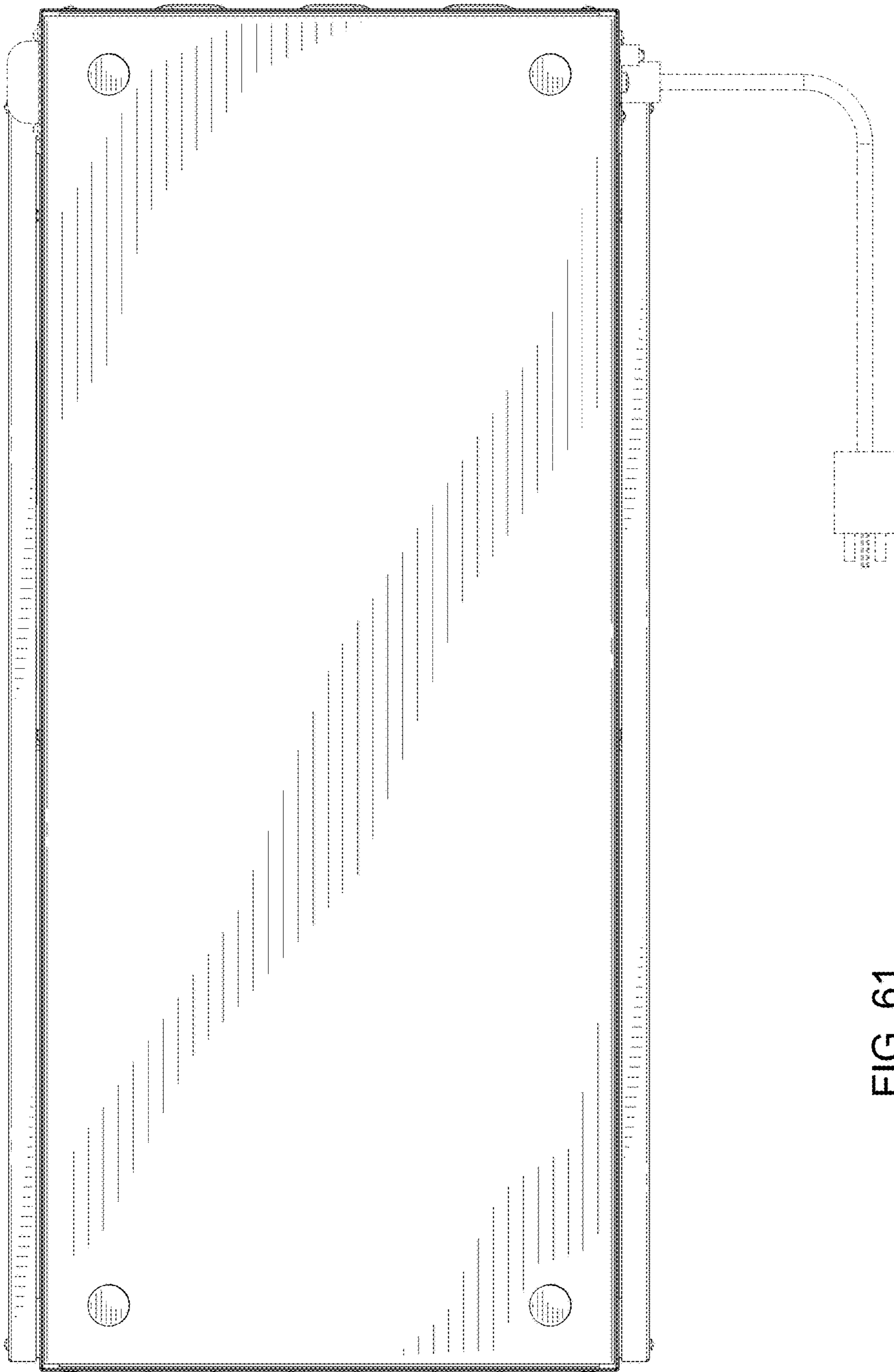

FIG. 61



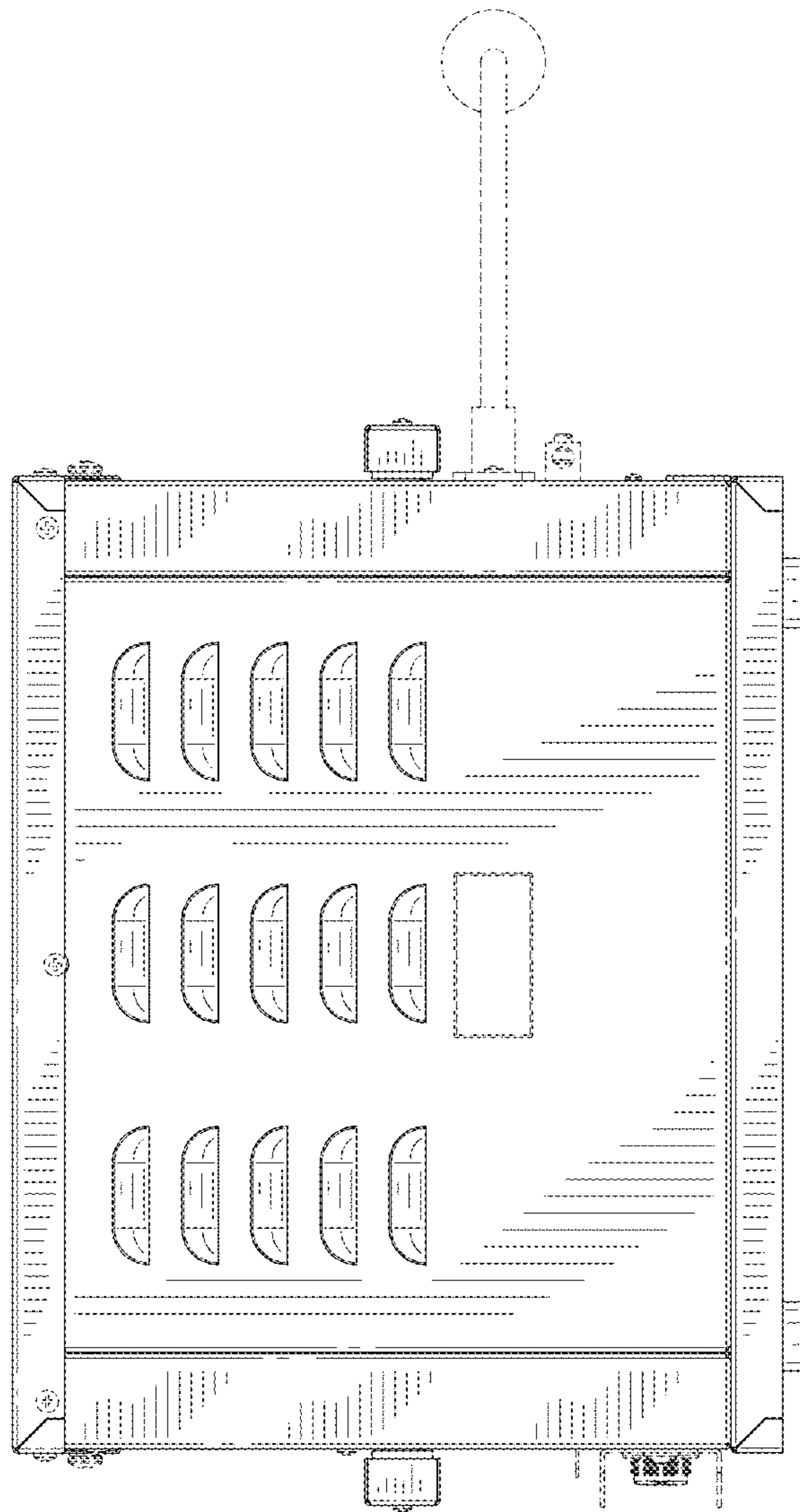

FIG. 62

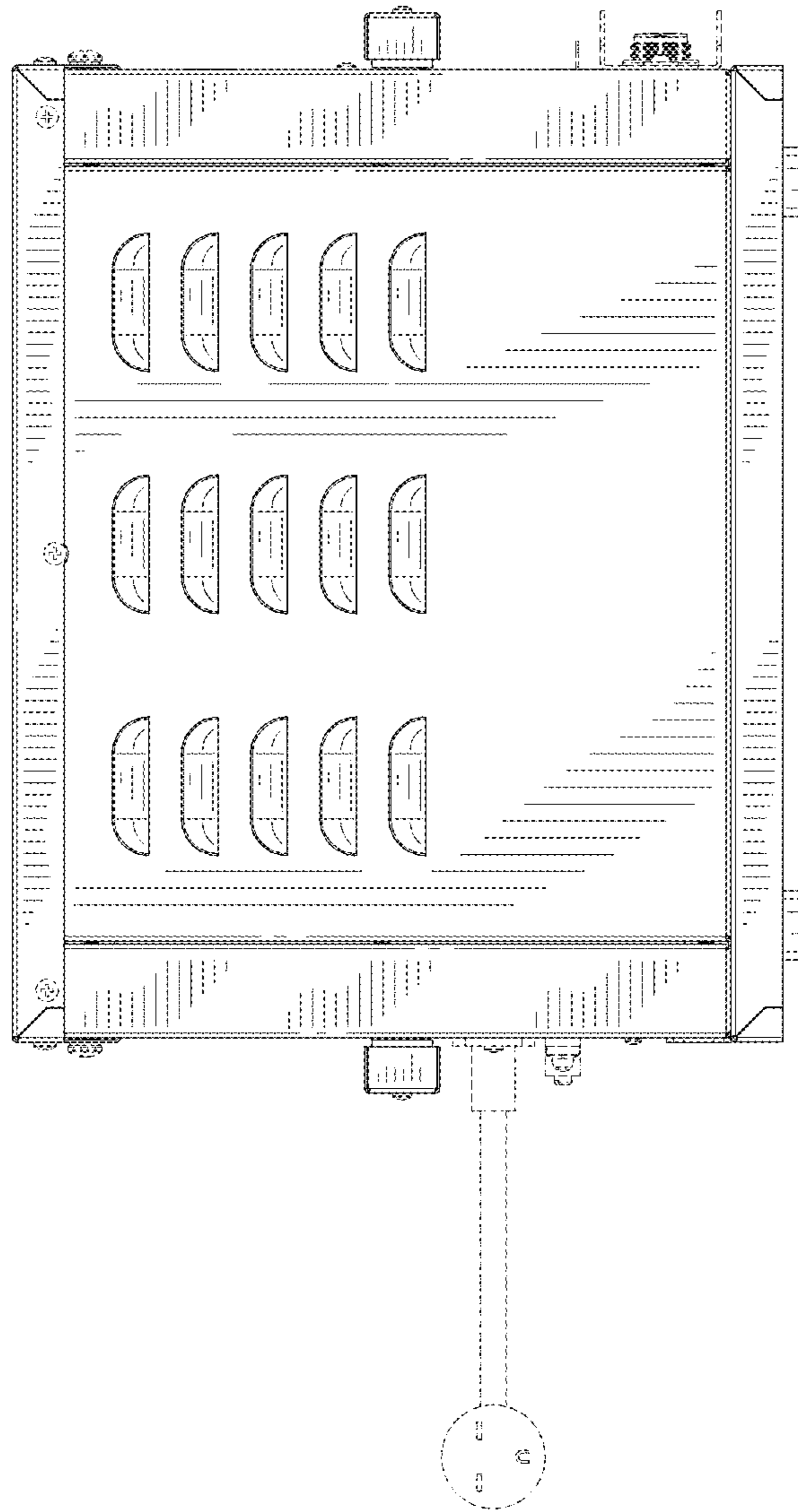

FIG. 63