



US00D809229S

(12) **United States Design Patent**
Lu

(10) **Patent No.:** **US D809,229 S**
(45) **Date of Patent:** **** Jan. 30, 2018**

(54) **VACUUM CLEANER**

(71) Applicant: **Tianjin Yulong Xinyuan Technology Co., Ltd, Tianjin (CN)**

(72) Inventor: **Aijun Lu, Tianjin (CN)**

(73) Assignee: **Tianjin Yulong Xinyuan Technology Co., Ltd, Tianjin (CN)**

(**) Term: **15 Years**

(21) Appl. No.: **29/575,726**

(22) Filed: **Aug. 29, 2016**

(51) **LOC (11) Cl.** **15-05**

(52) **U.S. Cl.**
USPC **D32/22**

(58) **Field of Classification Search**
USPC D32/17, 21, 22, 31, 34
CPC . A47L 9/32; A47L 9/325; A47L 9/327; A47L 9/20; A47L 5/28; A47L 5/30; A47L 5/34
See application file for complete search history.

(56) **References Cited**

U.S. PATENT DOCUMENTS

D486,614 S * 2/2004 Beauchamp D32/22
D496,503 S * 9/2004 Chen 32/16

D517,260 S * 3/2006 Moine D32/22
D646,858 S * 10/2011 Smith D32/22
D769,556 S * 10/2016 Kim D32/22
D790,784 S * 6/2017 Bruneel D32/22

* cited by examiner

Primary Examiner — Ruth McInroy

(74) *Attorney, Agent, or Firm* — Lin & Associates
Intellectual Property, Inc.

(57) **CLAIM**

The ornamental design for a vacuum cleaner, as shown and described.

DESCRIPTION

FIG. 1 is a front perspective view of a vacuum cleaner showing my new design;
FIG. 2 is a front elevational view thereof;
FIG. 3 is a rear elevational view thereof;
FIG. 4 is a left elevational view thereof;
FIG. 5 is a right elevational view thereof;
FIG. 6 is a top view thereof;
FIG. 7 is a bottom view thereof;
FIG. 8 is a bottom, front perspective view thereof; and,
FIG. 9 is a top, rear perspective view thereof.
The details shown in broken lines form no part of the claimed design.

1 Claim, 9 Drawing Sheets

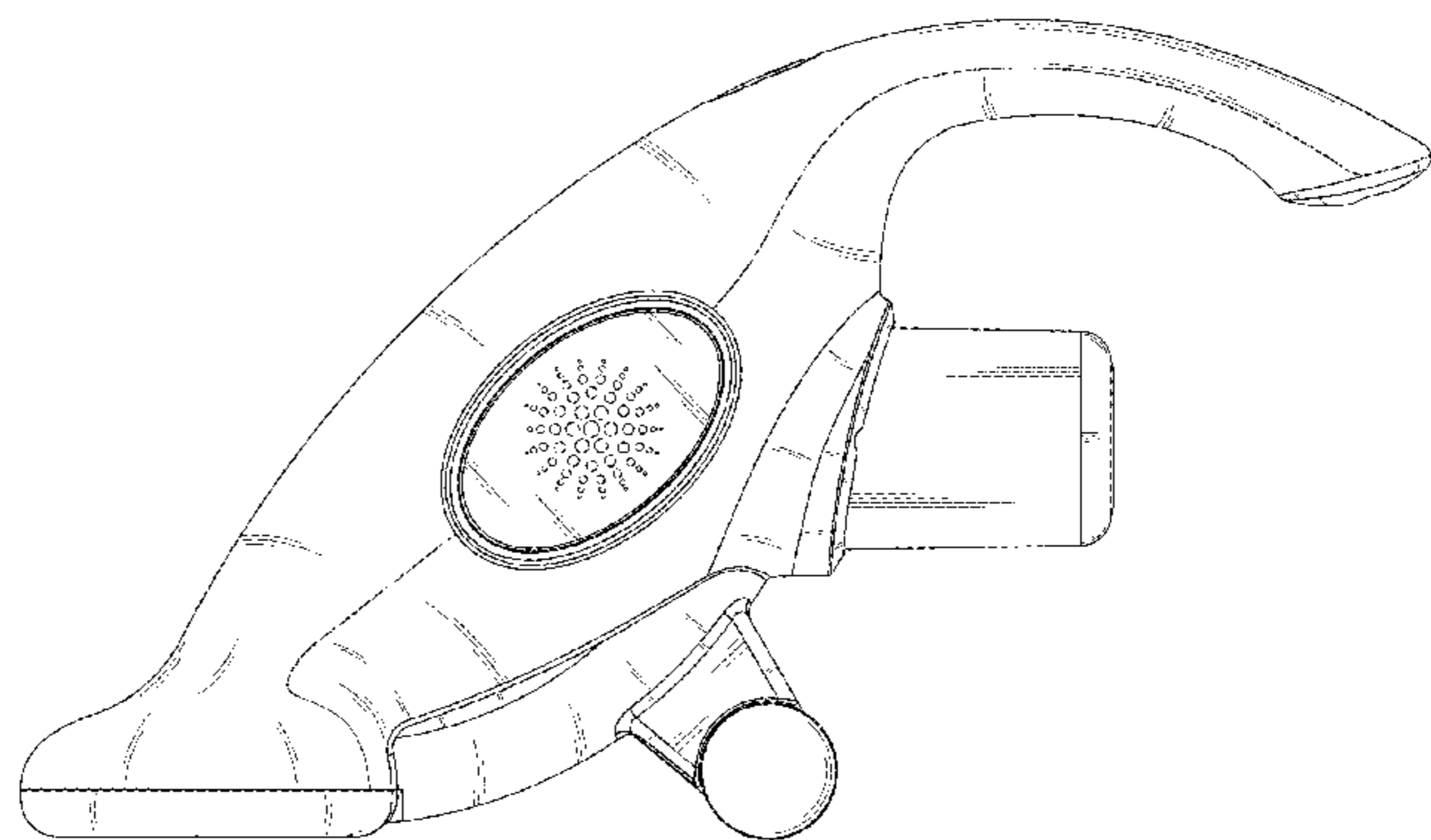
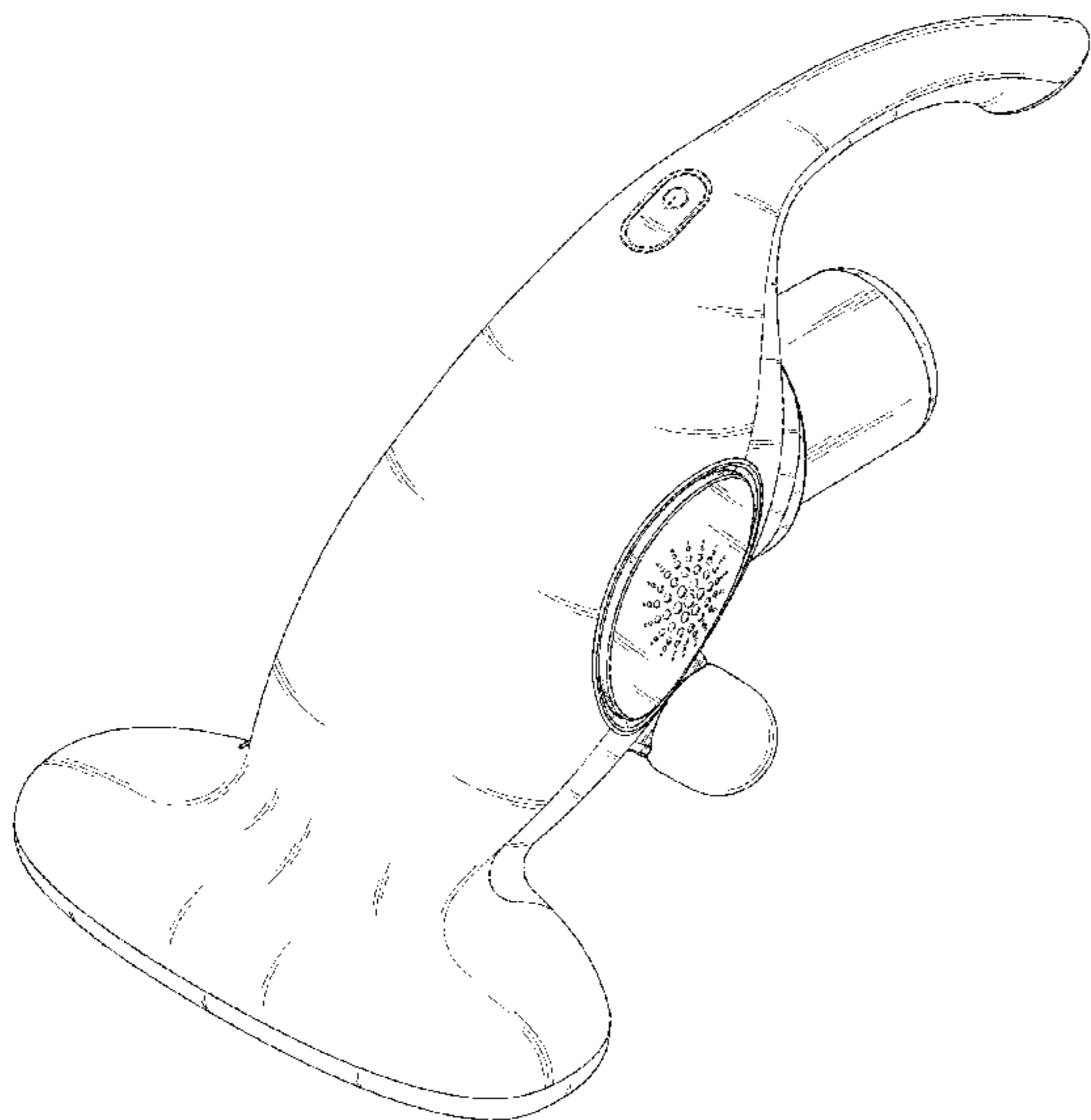

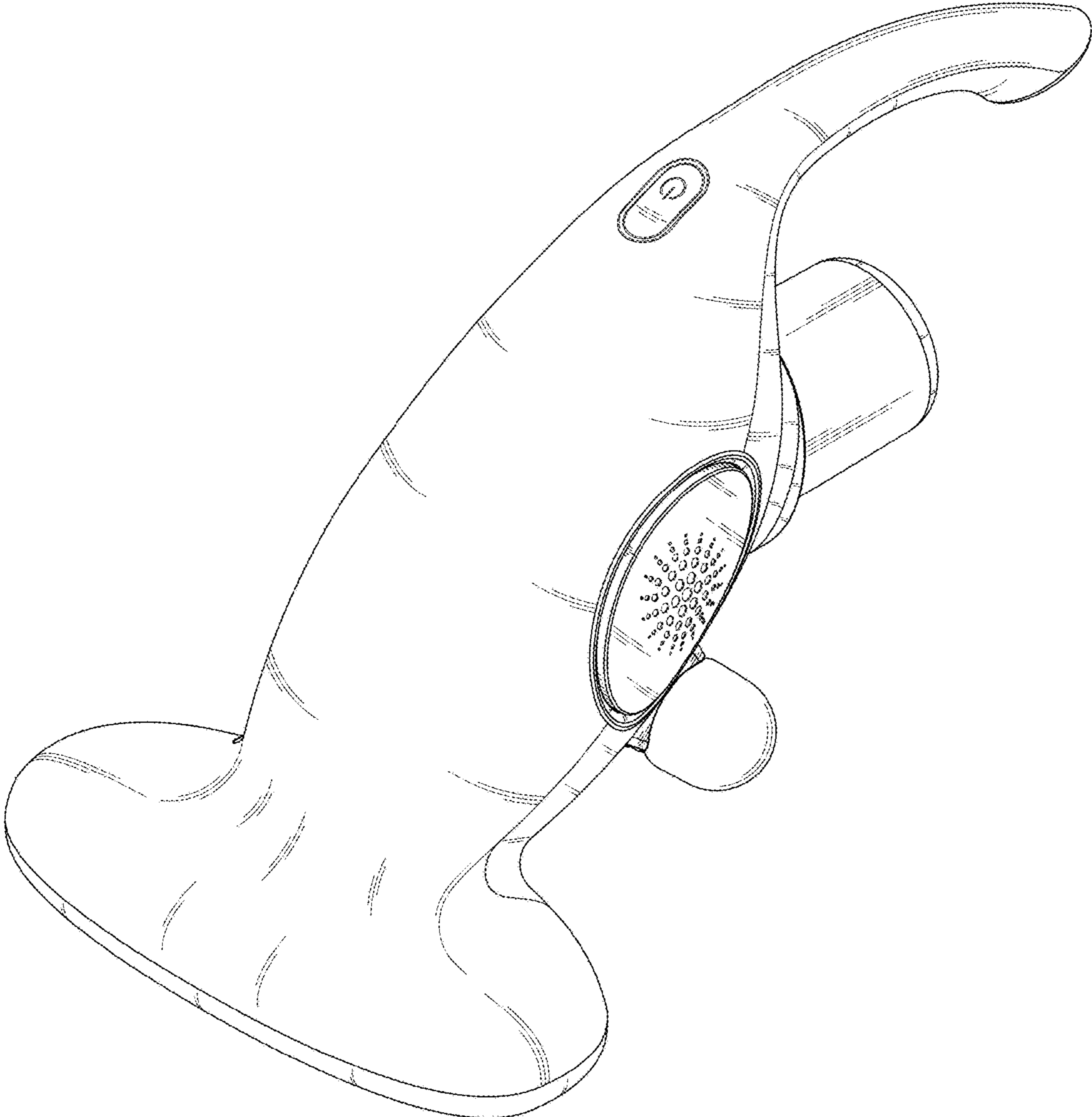

FIG. 1

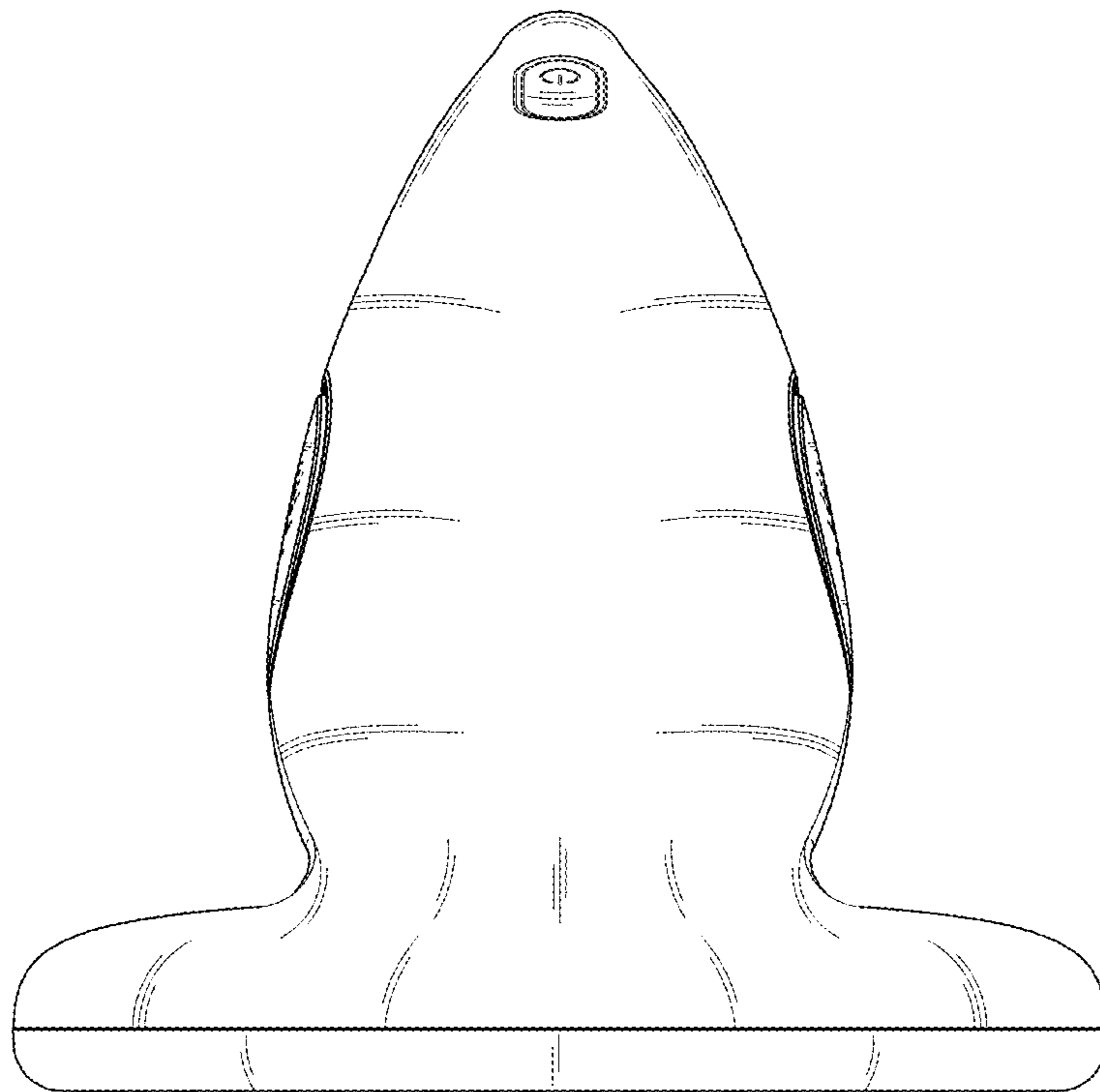

FIG. 2

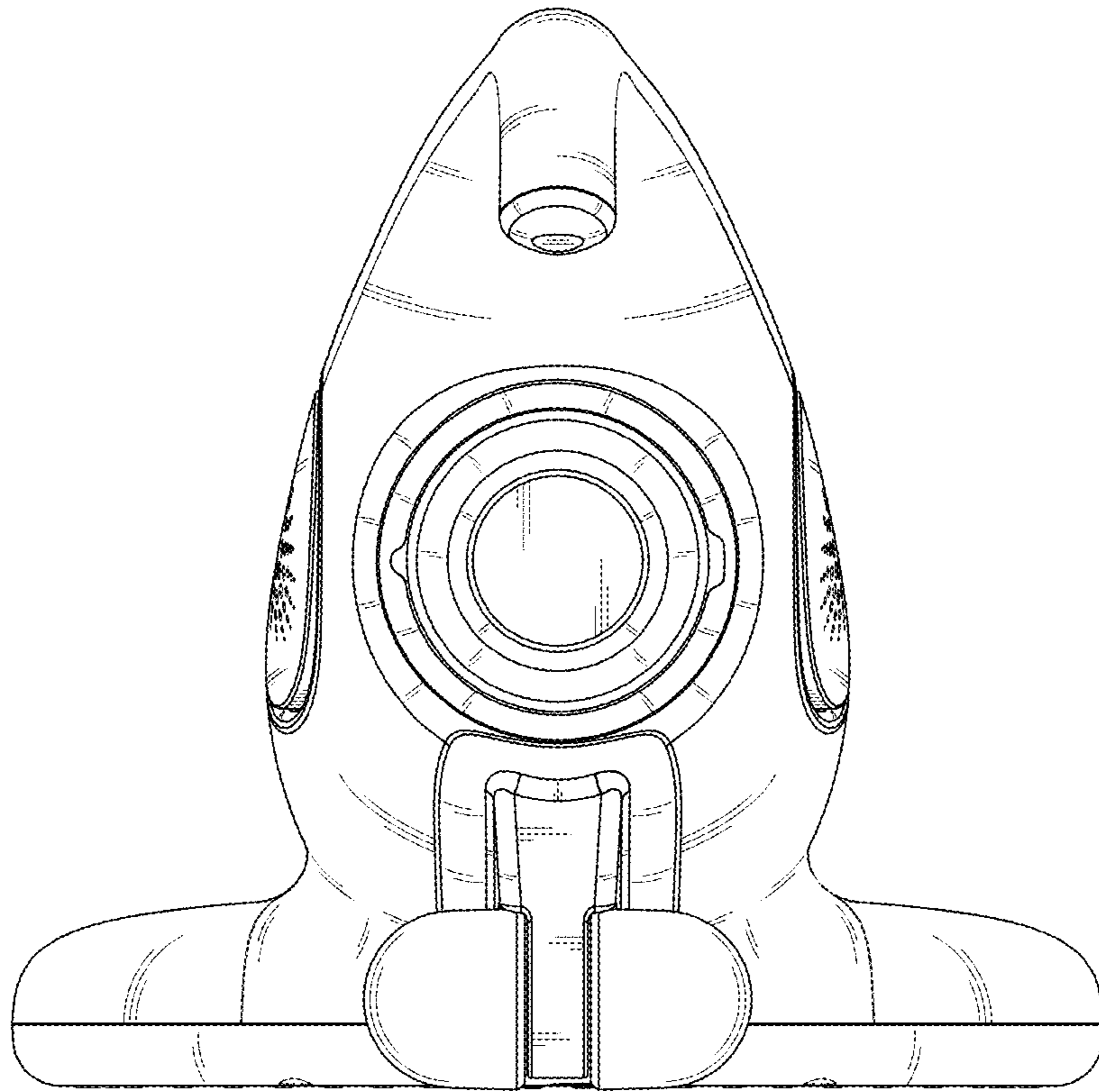

FIG. 3

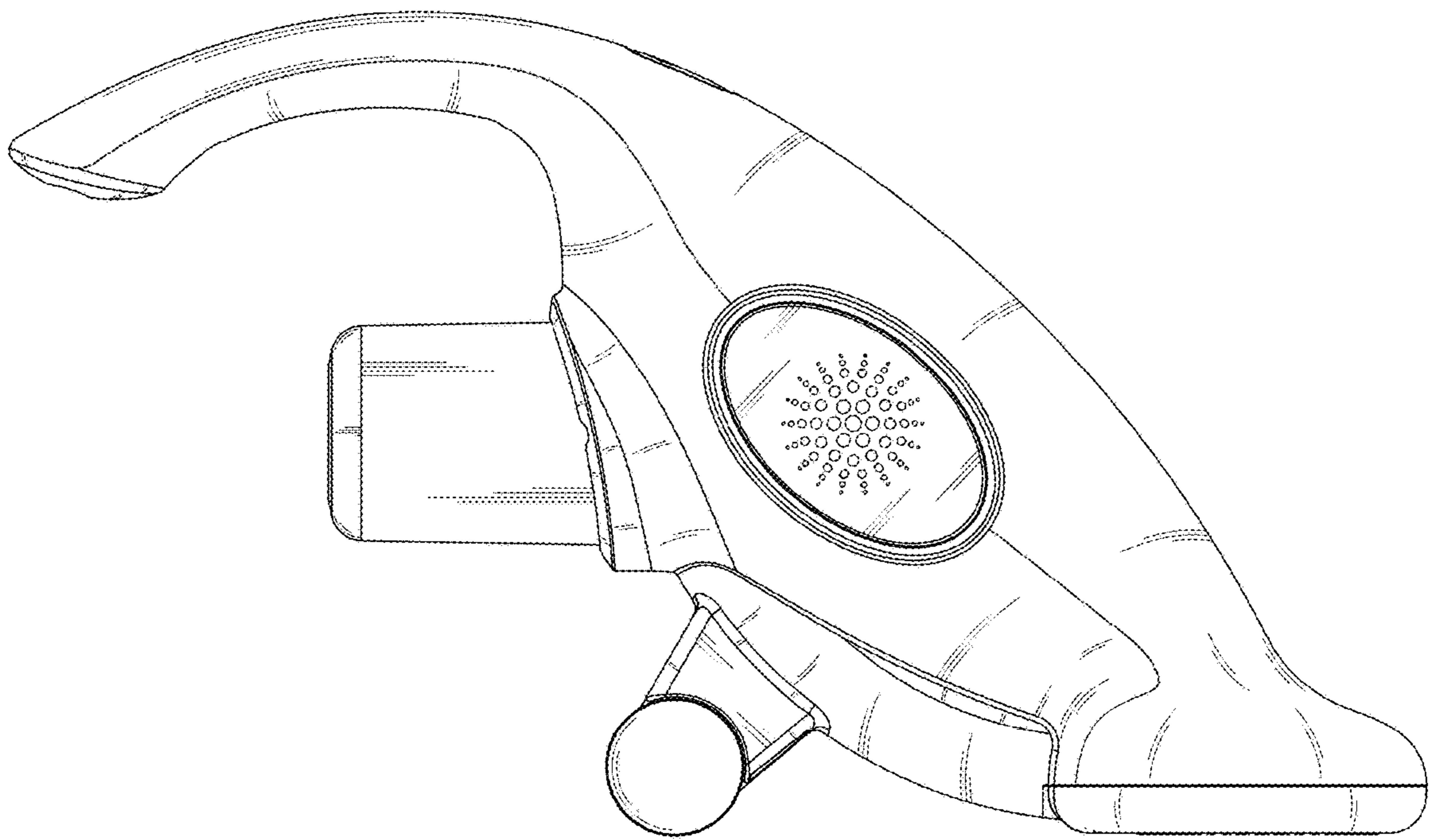

FIG. 4

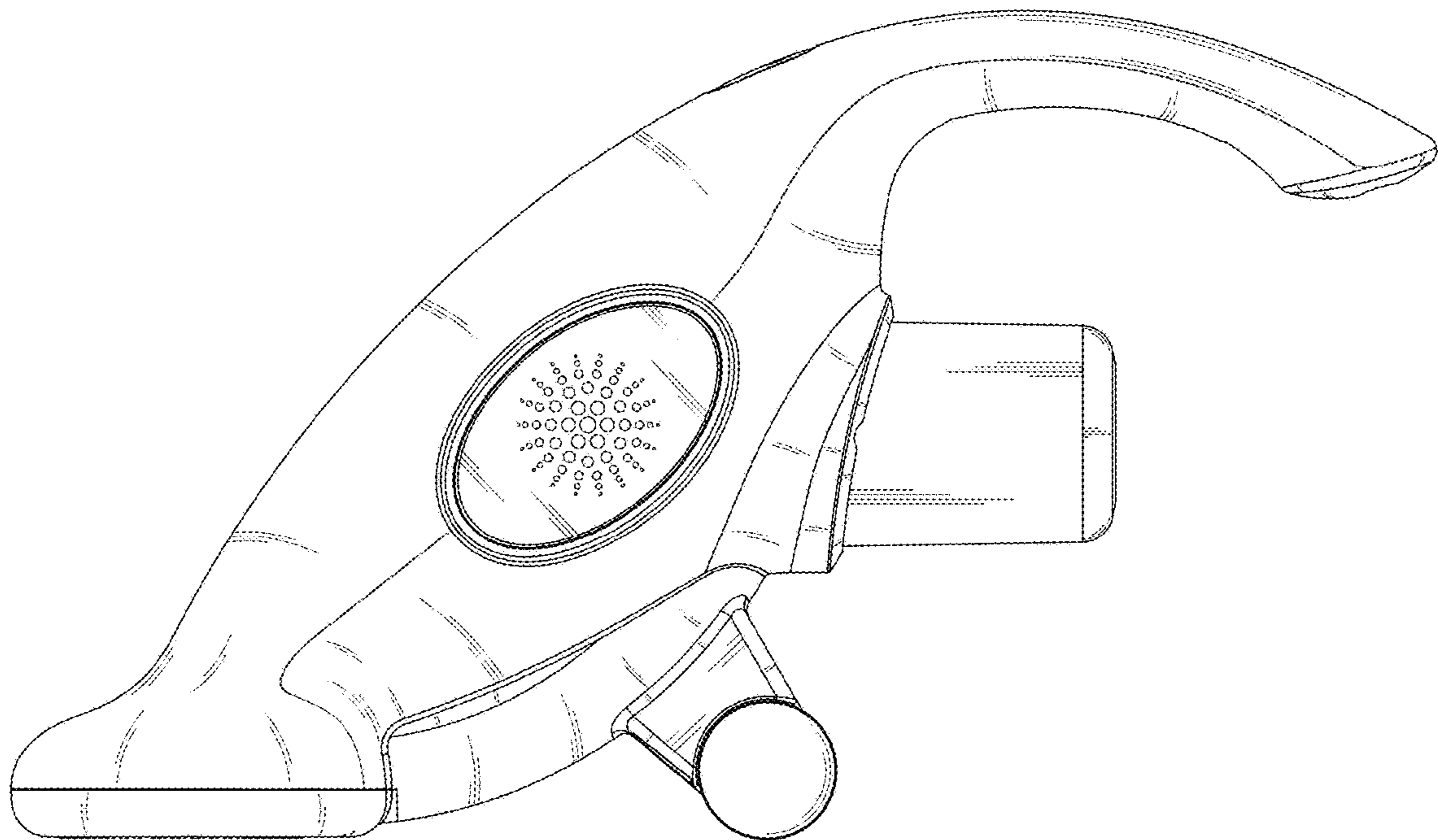

FIG. 5

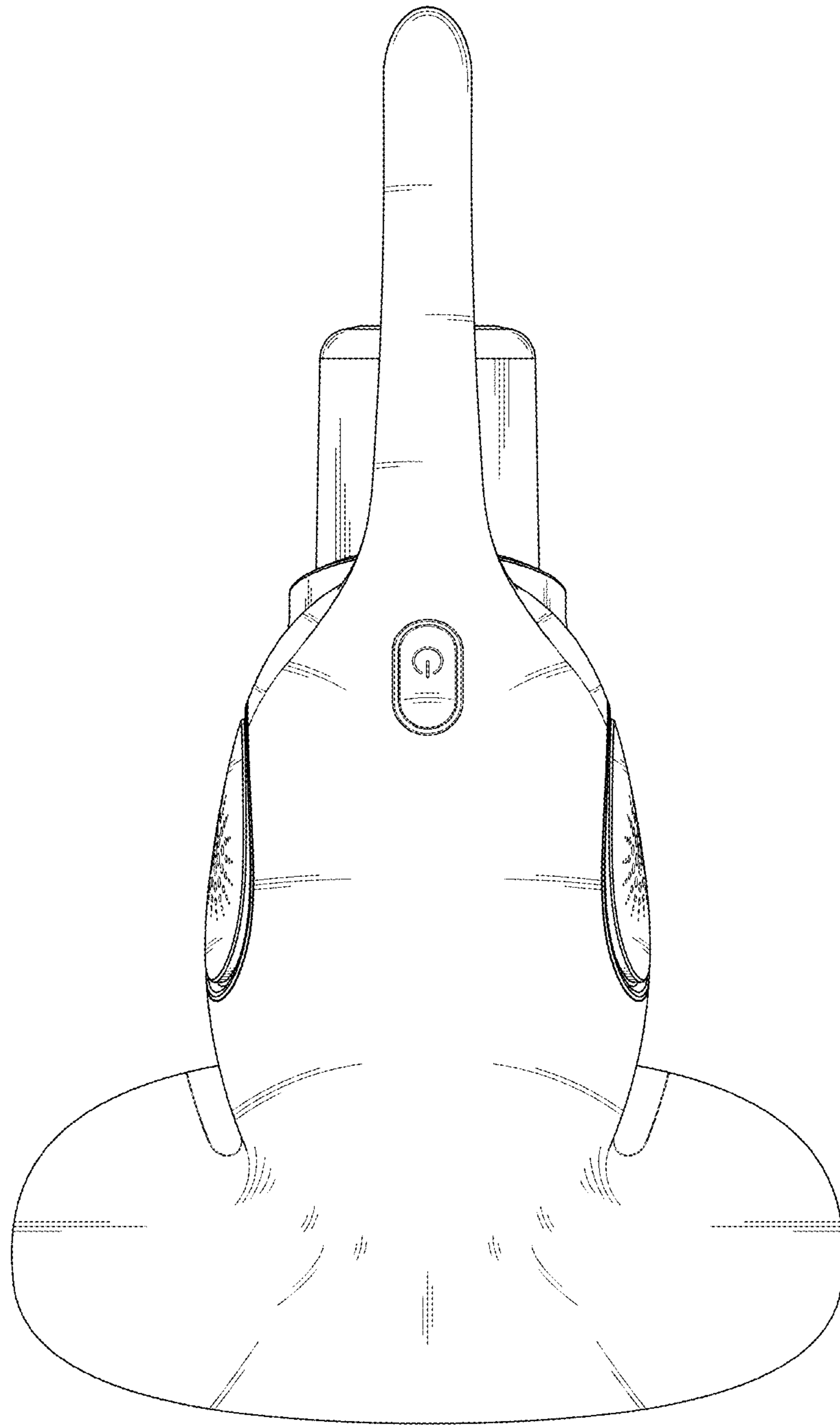

FIG. 6

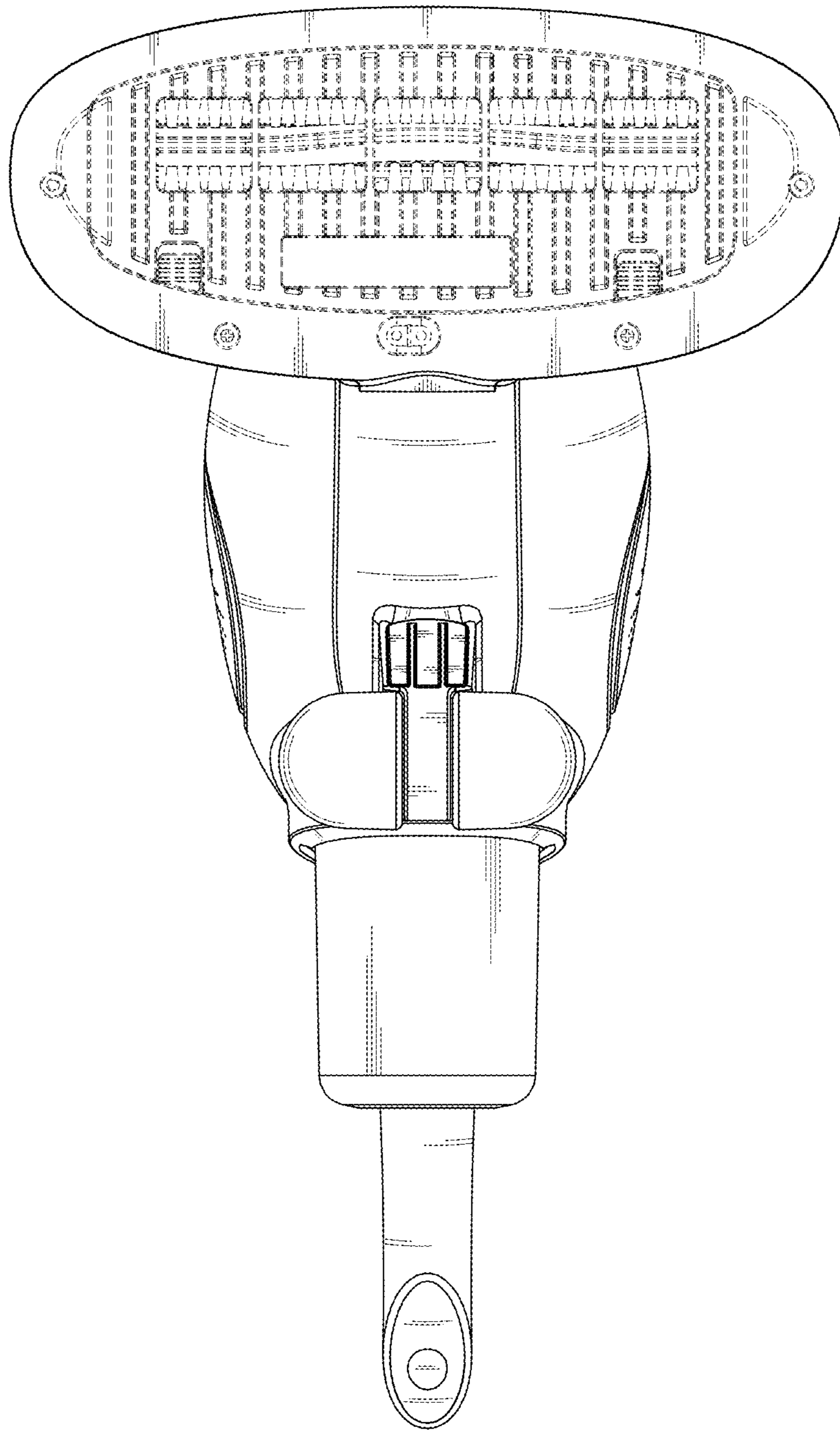

FIG. 7

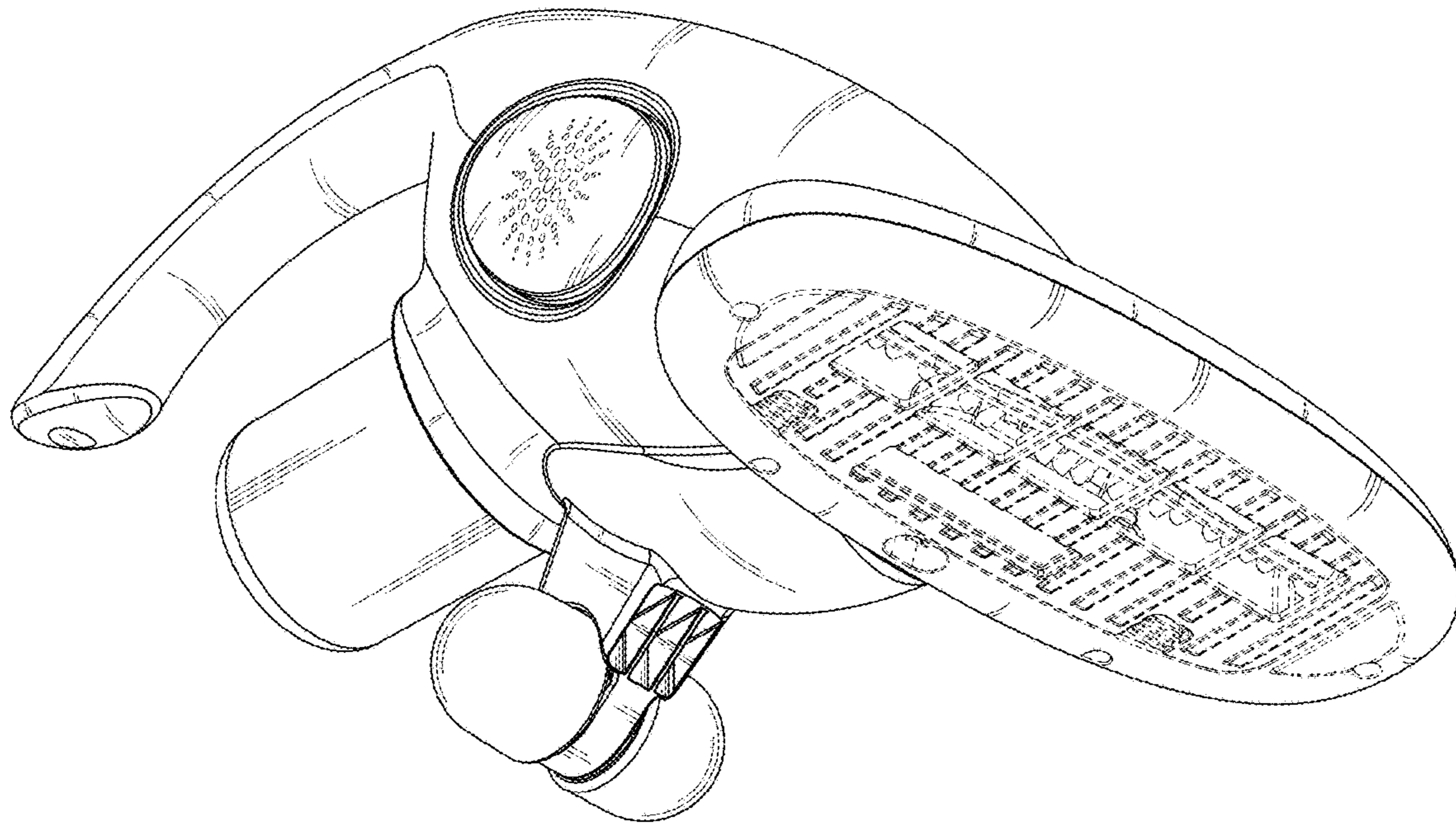

FIG. 8

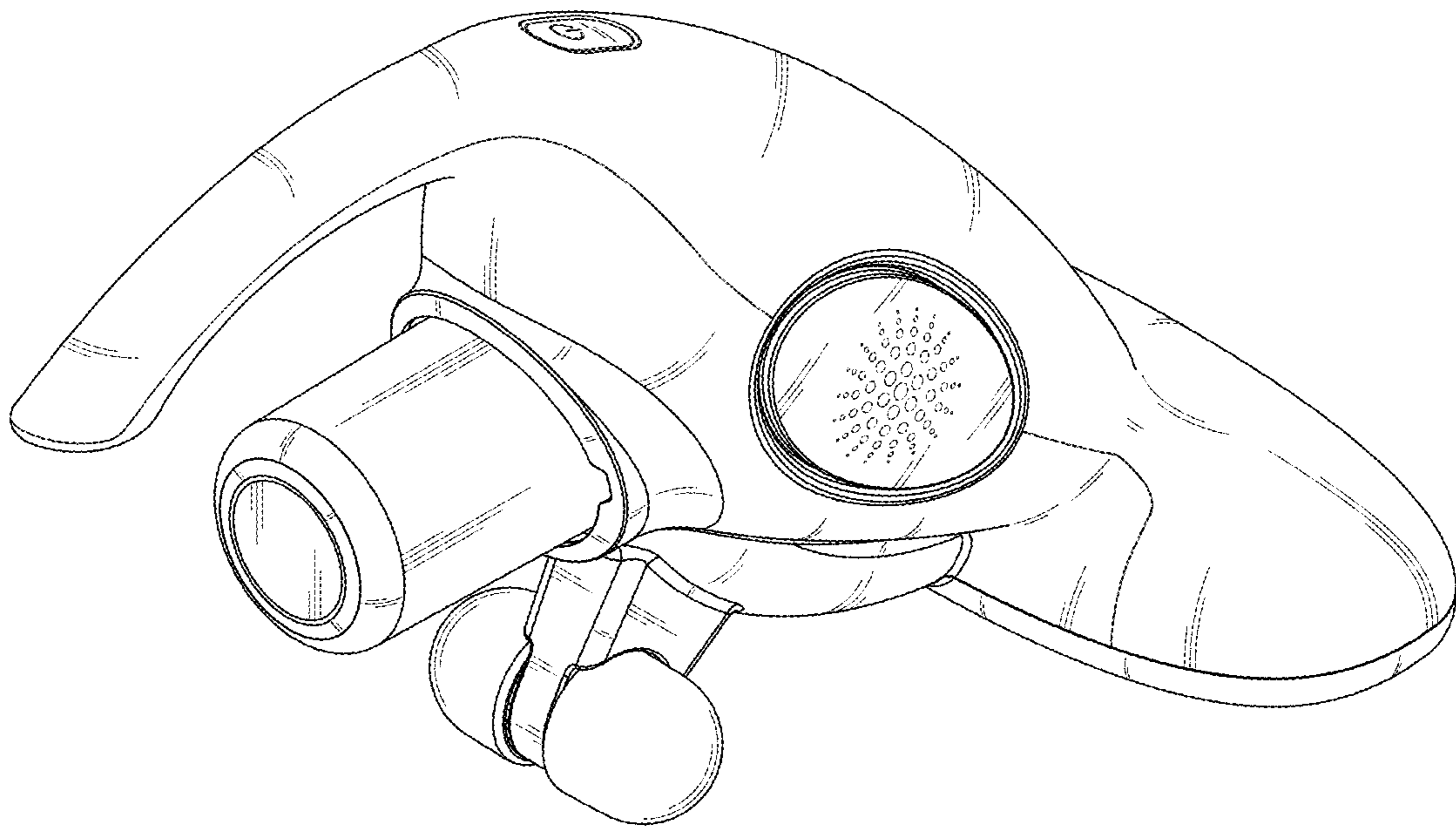

FIG. 9