



US00D809217S

(12) **United States Design Patent**
Axelrod et al.

(10) **Patent No.:** **US D809,217 S**
(45) **Date of Patent:** **** Jan. 30, 2018**

(54) **FLEA COMB**

(71) Applicant: **T.F.H. PUBLICATIONS, INC.**,
Neptune City, NJ (US)

(72) Inventors: **Glen S. Axelrod**, Colts Neck, NJ (US);
Ajay Gajria, Maharashtra (IN)

(73) Assignee: **T.F.H. PUBLICATIONS, INC.**,
Neptune City, NJ (US)

(**) Term: **15 Years**

(21) Appl. No.: **29/555,509**

(22) Filed: **Feb. 23, 2016**

(51) **LOC (11) Cl.** **30-99**

(52) **U.S. Cl.**

USPC **D30/159**

(58) **Field of Classification Search**

USPC D30/158, 159, 199, 162, 106; 119/625,
119/633, 600, 617, 628, 632, 631, 613,
119/618, 619, 620, 611; 132/126, 142;
30/114, 130, 301, 305, 315, 316, 299,
30/303, 306, 169, 322, 31, 30, 279.2,
30/280, 287, 294, 199, 329-344, 346.56,
30/346.61, 355, 357; D7/672-676, 687,
D7/686, 634, 619, 688, 653; 425/298;
426/503; D4/136, 127, 124-126,
D4/116-118, 199, 194; D32/42, 25;
D23/261; 2/160; 172/379, 380; D6/415,
D6/410, 411; 294/1.3, 1.5, 55, 99.1, 49,
294/7, 9, 99.2, 118, 119, 19.2, 52;
209/418; D24/211, 147; D21/532, 398;
D19/36; 34/381, 103, 104, 107;
D11/104, 86; 56/400.01, 400.1, 400.17,
56/400.21, 400.05, 400.04, 330; 403/329,
403/326, 361; 15/402, 142, 236.07,
15/236.08, 236.05; 601/137, 136, 80, 93,
601/95, 97, 101, 103, 138, 143-147;
D28/91.2, 63, 52, 31; D8/13, 6, 10, 11,
D8/12, 1; 126/173, 214 C, 25 R; 99/450

CPC A01K 13/00; A01K 13/002; B26B 19/24;
B26B 19/063; B26B 21/16; B26B 21/18;
B26B 21/521; B26B 21/4075; B26B
21/522; A45D 24/30; A45D 24/00; A45D
24/04; A45D 24/10; A45D 24/36; A45D
24/02; A46B 5/02; A46B 5/021; A46B
5/026; A46B 5/028; A46B 2200/1093;
A46B 2200/10

See application file for complete search history.

(56) **References Cited**

U.S. PATENT DOCUMENTS

2,596,296 A * 5/1952 Shields A45D 24/24
132/108
D184,870 S * 4/1959 Heinrich D28/24
D199,718 S * 12/1964 Adler D28/31
D205,821 S * 9/1966 Lattimer 132/118

(Continued)

FOREIGN PATENT DOCUMENTS

CA 422776 9/1944
GB 2214804 9/1989

Primary Examiner — Susan Moon Lee

(74) *Attorney, Agent, or Firm* — Grossman, Tucker,
Perreault & Pflieger, PLLC

(57) **CLAIM**

We claim the ornamental design for a flea comb, as shown
and described.

DESCRIPTION

FIG. 1 is a perspective view of a flea comb of the present
invention;
FIG. 2 is a back view of the flea comb of FIG. 1;
FIG. 3 is a front view of the flea comb of FIG. 1;
FIG. 4 is a left side view of the flea comb of FIG. 1, the right
side view being a mirror image thereof;
FIG. 5 is a top end view of the flea comb of FIG. 1; and,
FIG. 6 is a bottom end view of the flea comb of FIG. 1.

1 Claim, 4 Drawing Sheets

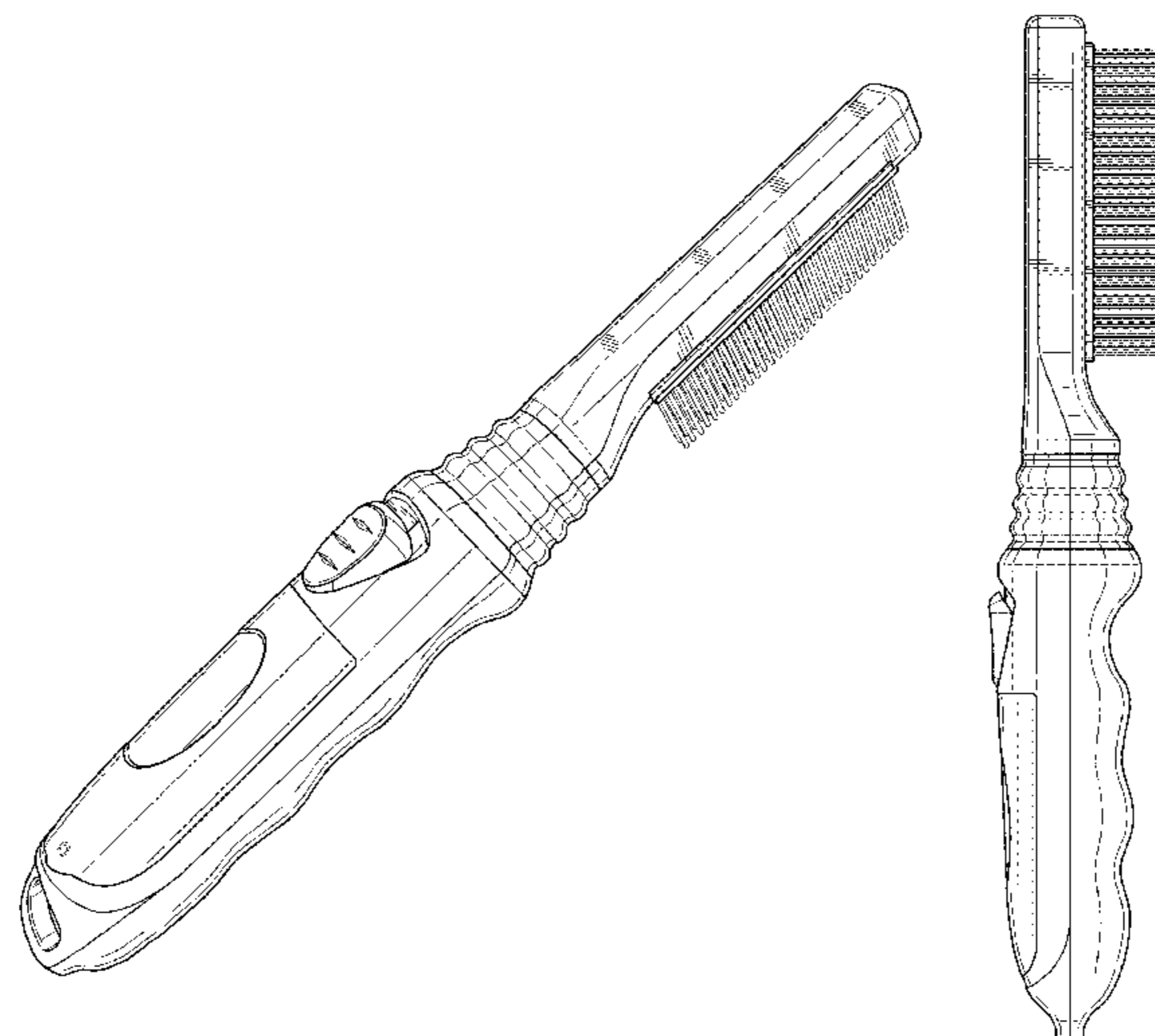

(56)

References Cited

U.S. PATENT DOCUMENTS

D209,724 S * 12/1967 McNair et al. D28/24
 D222,014 S * 9/1971 Steinkamp D28/12
 D226,148 S * 1/1973 Rizzuto et al. D28/24
 D226,585 S * 3/1973 Rakocy D28/24
 D226,877 S * 5/1973 Tucker D28/24
 3,927,684 A 12/1975 Lam
 D253,849 S * 1/1980 Schroeder D28/24
 4,226,251 A 10/1980 Wall
 4,936,259 A 6/1990 Owen et al.
 D309,984 S * 8/1990 Gingras D4/138
 5,479,951 A * 1/1996 Denebeim A45D 2/2478
 132/120
 D373,904 S * 9/1996 Vanderhoef D4/138
 5,584,088 A * 12/1996 Pauldine A46B 7/10
 15/27
 D381,483 S * 7/1997 Hartman D32/48
 D399,722 S * 10/1998 Eidsmoe D8/107
 5,996,231 A * 12/1999 Roche B26B 5/00
 30/169
 D442,446 S * 5/2001 Hortnagl D8/10
 6,336,428 B1 * 1/2002 Locke A01K 13/002
 119/611
 D470,981 S * 2/2003 Simon D30/158
 D497,033 S * 10/2004 Micinilio D28/24
 D504,234 S * 4/2005 Kuo D4/133
 D504,776 S * 5/2005 Kuo D4/133

D507,682 S * 7/2005 Dunn D30/158
 D513,349 S * 12/2005 Hammer D30/158
 D610,756 S * 2/2010 Lin D30/159
 D614,819 S * 4/2010 Lin D30/159
 8,132,541 B1 * 3/2012 Baer, Jr. A01K 13/002
 119/664
 D679,459 S * 4/2013 Matz D30/158
 D794,249 S * 8/2017 Hou D28/24
 D796,116 S * 8/2017 Watkins D28/24
 2004/0144395 A1 * 7/2004 Evans A61B 17/06066
 128/885
 2009/0235475 A1 * 9/2009 Bohannon A46B 5/0095
 15/111
 2009/0272331 A1 * 11/2009 Lin A01K 13/002
 119/625
 2009/0272332 A1 * 11/2009 Lin A01K 13/002
 119/633
 2009/0272333 A1 * 11/2009 Lin A01K 13/002
 119/633
 2011/0048336 A1 * 3/2011 Lin A01K 13/002
 119/625
 2012/0051085 A1 3/2012 Albaladejo Jimenez
 2013/0133587 A1 * 5/2013 Pelfrey A01K 13/00
 119/625
 2013/0343041 A1 12/2013 Renforth et al.
 2014/0261225 A1 * 9/2014 Lee A01K 13/002
 119/625

* cited by examiner

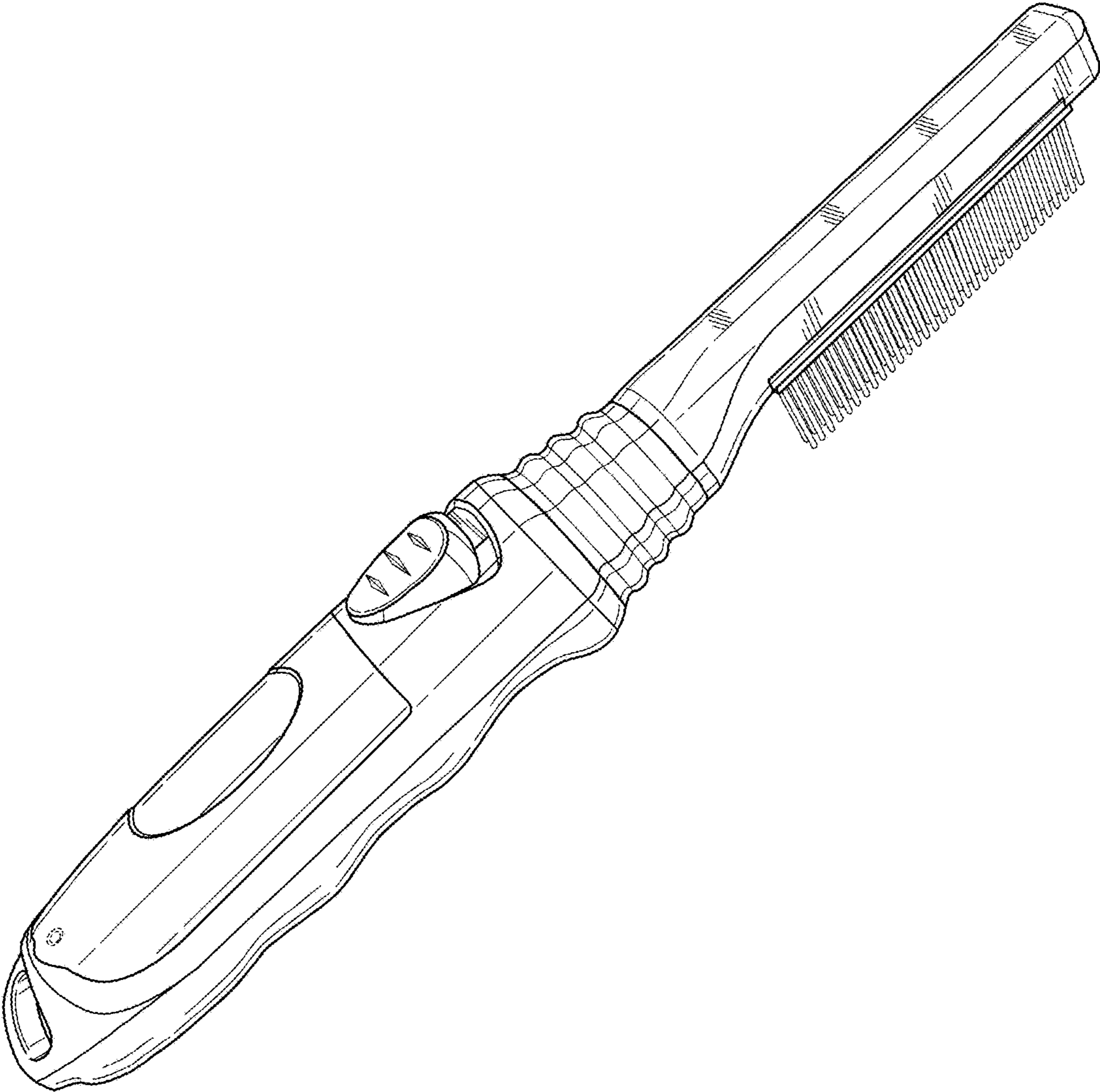

FIG. 1

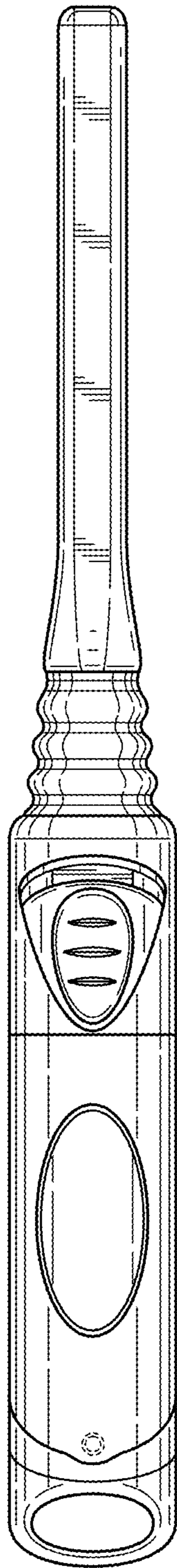

FIG. 2

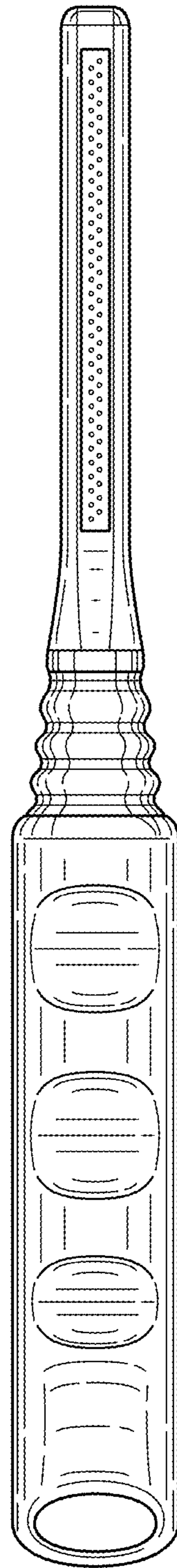

FIG. 3

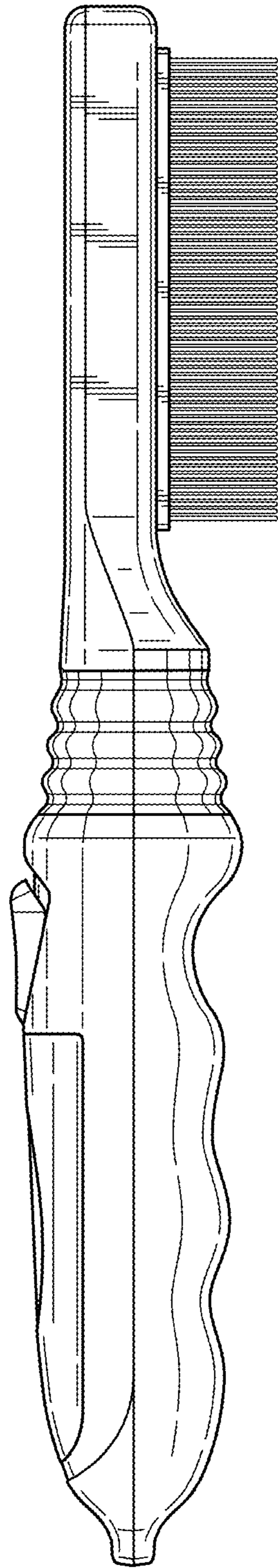

FIG. 4

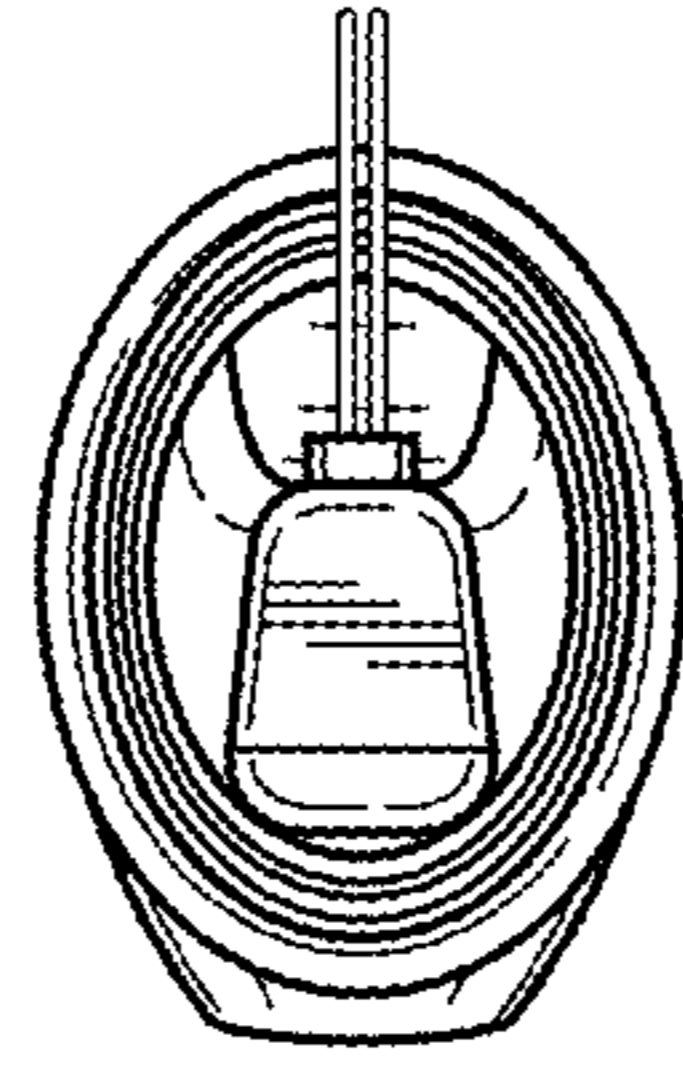

FIG. 5

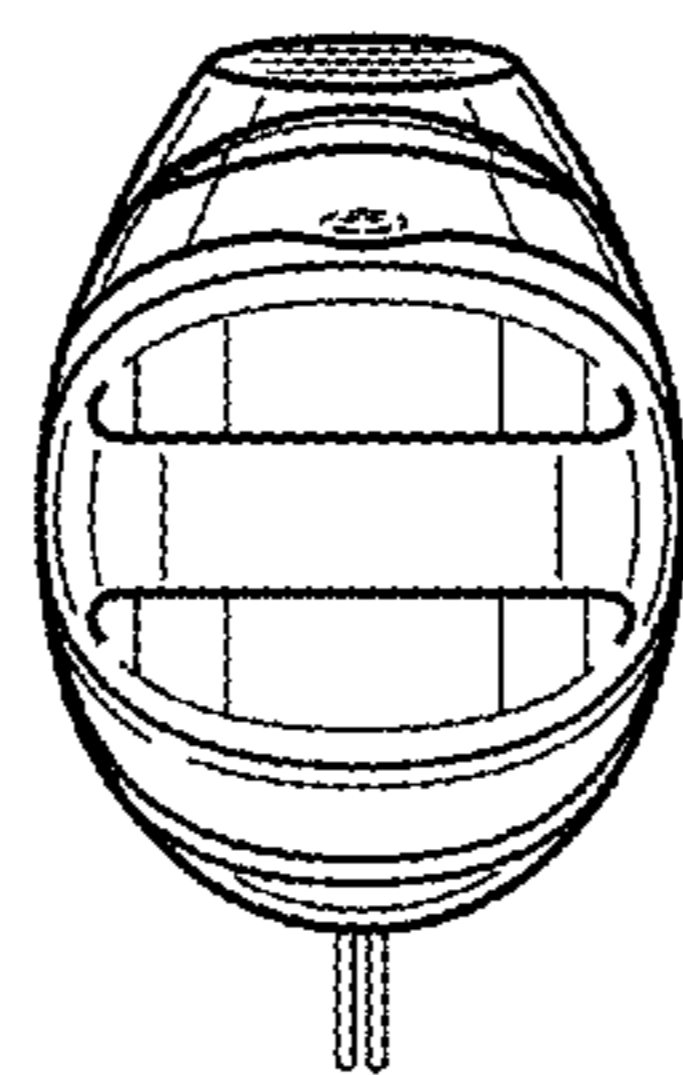

FIG. 6