



US00D809206S

(12) **United States Design Patent** (10) **Patent No.:** **US D809,206 S**
Boulanger (45) **Date of Patent:** **** Jan. 30, 2018**

(54) **BEARD TRIMMER**
(71) Applicant: **KONINKLIJKE PHILIPS N.V.**,
Eindhoven (NL)
(72) Inventor: **Florian Jeremy Fabrice Boulanger**,
Eindhoven (NL)
(73) Assignee: **KONINKLIJKE PHILIPS N.V.**,
Eindhoven (NL)

(**) Term: **15 Years**
(21) Appl. No.: **35/501,161**

(22) Filed: **Jan. 5, 2016**

(80) **Hague Agreement Data**

Int. Filing Date: **Jan. 5, 2016**
Int. Reg. No.: **DM/088930**
Int. Reg. Date: **Jan. 5, 2016**
Int. Reg. Pub. Date: **Jul. 8, 2016**

(30) **Foreign Application Priority Data**

Aug. 12, 2015 (EM) 002753293-0001

(51) **LOC (11) Cl.** **28-03**
(52) **U.S. Cl.**
USPC **D28/53**

(58) **Field of Classification Search**

USPC D28/49-53
CPC B26B 19/06; B26B 19/20; B26B 19/3846;
B26B 19/28; B26B 19/3806; B26B
19/3813; B26B 19/3826; B26B 19/48
See application file for complete search history.

(56) **References Cited**

U.S. PATENT DOCUMENTS

D600,409 S * 9/2009 Klein D28/53
D653,812 S * 2/2012 Julemont D28/53
D683,900 S * 6/2013 Julemont D28/53
D720,887 S * 1/2015 Gross D28/53

D720,888 S * 1/2015 Colle D28/53
D751,759 S * 3/2016 Aulwes D28/53
D759,309 S * 6/2016 Reuter D28/53
D763,507 S * 8/2016 Teteak D28/51
D784,618 S * 4/2017 Mori D28/53
D784,619 S * 4/2017 Mori D28/53
D787,746 S * 5/2017 Werner D28/53
2012/0233865 A1 * 9/2012 Kammer B26B 19/3846
30/201

* cited by examiner

Primary Examiner — George D Kirschbaum

Assistant Examiner — Jennifer Watkins

(57) **CLAIM**

The ornamental design for beard trimmer, as shown and described.

DESCRIPTION

1. Beard trimmer

Fig. 1.1 is a perspective view showing the beard trimmer of my design;

Fig. 1.2 is a front elevational view thereof;

Fig. 1.3 is a rear elevational view thereof;

Fig. 1.4 is a left side elevational view thereof;

Fig. 1.5 is a right side elevational view thereof;

Fig. 1.6 is a top plan view thereof; and

Fig. 1.7 is a bottom view thereof.

The portions of the beard trimmer shown in broken lines are included for the purpose of illustrating unclaimed portions of the beard trimmer and form no part of the claimed design.

1 Claim, 6 Drawing Sheets

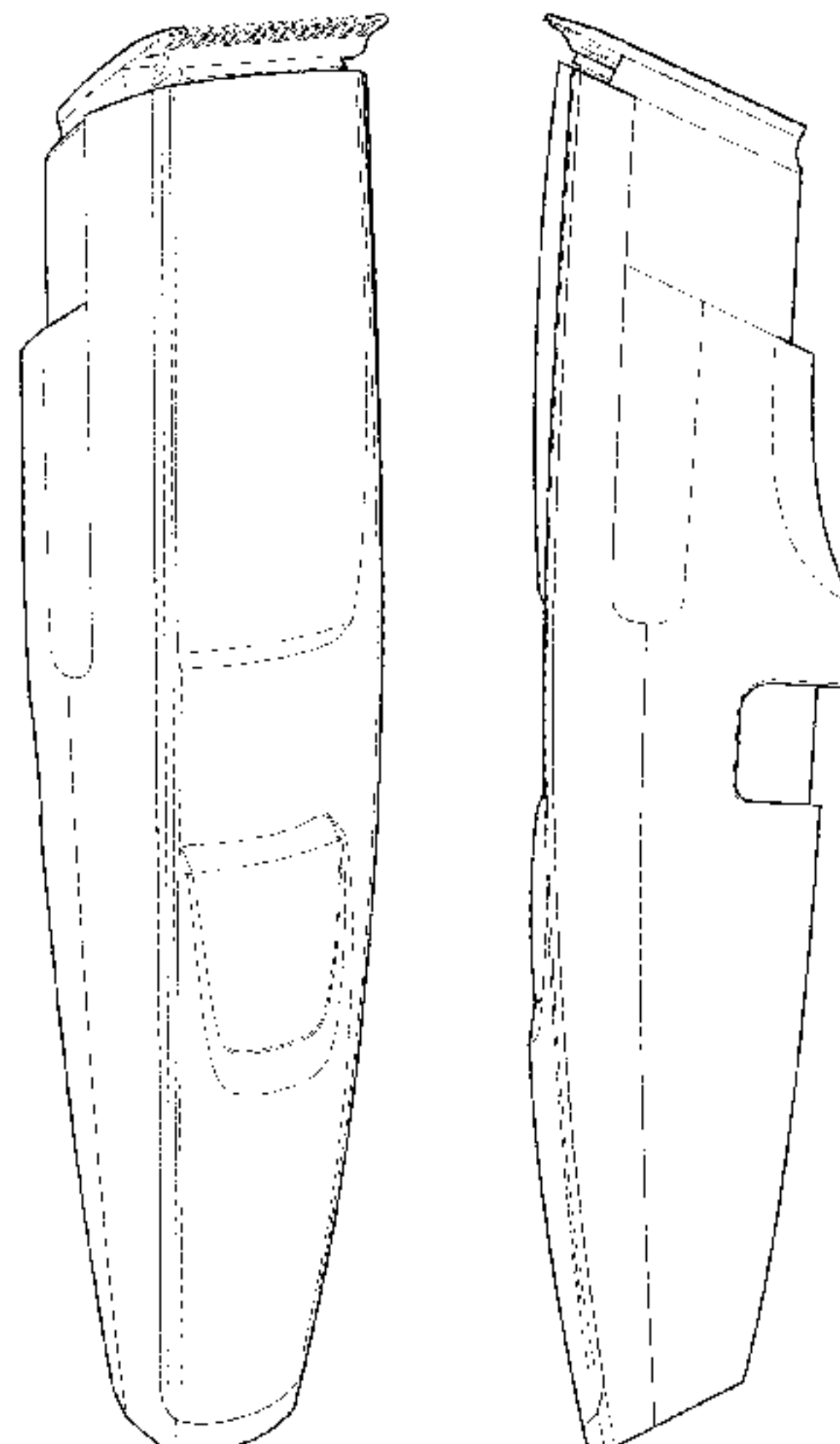

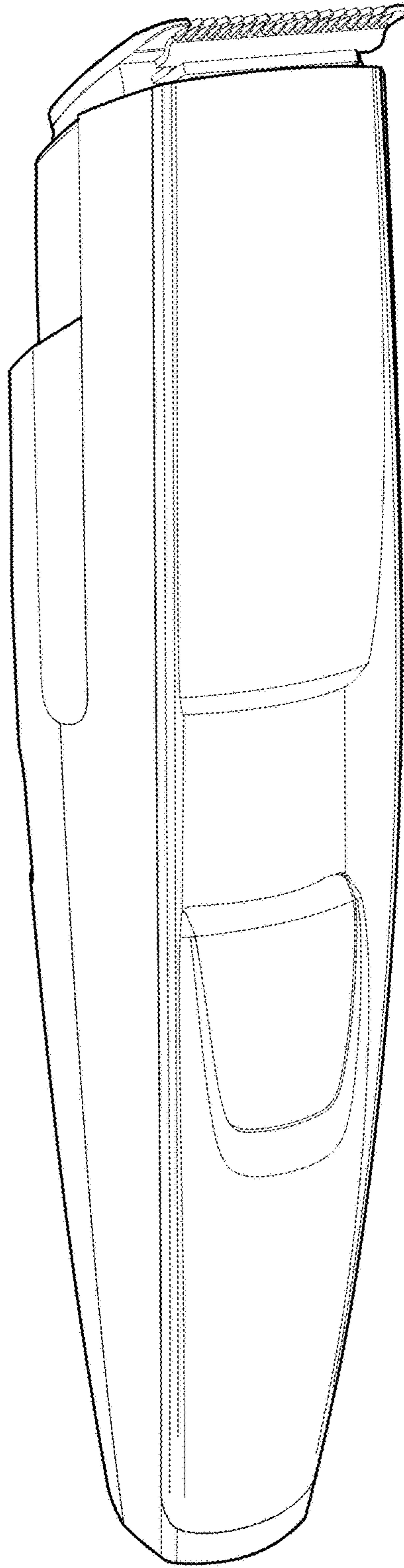

1.1

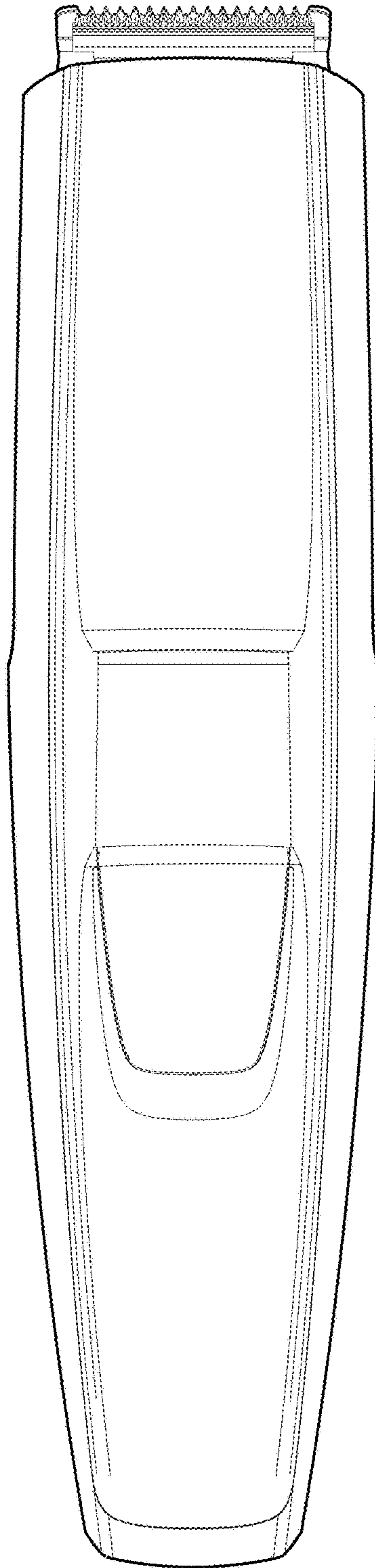

1.2

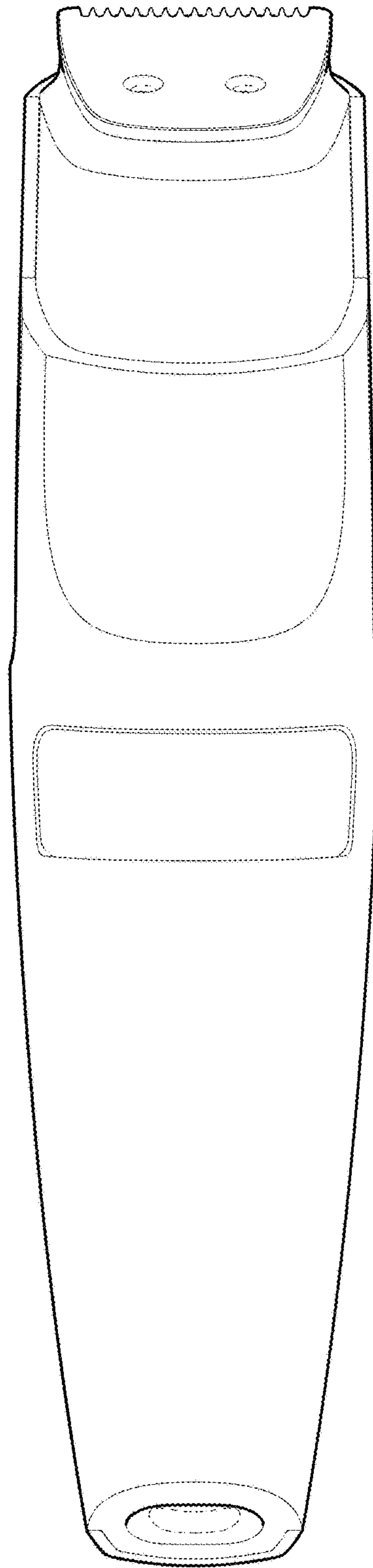

1.3

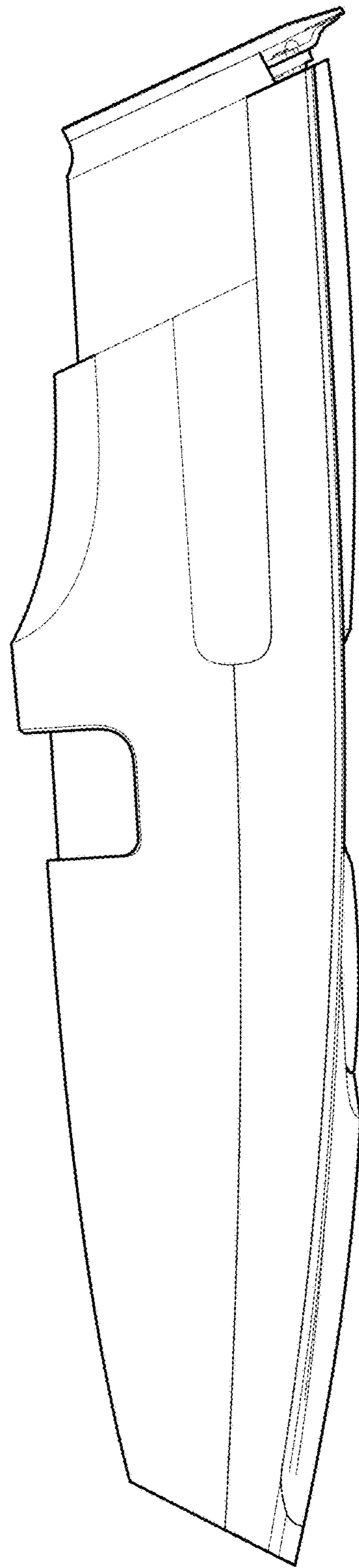

1.4

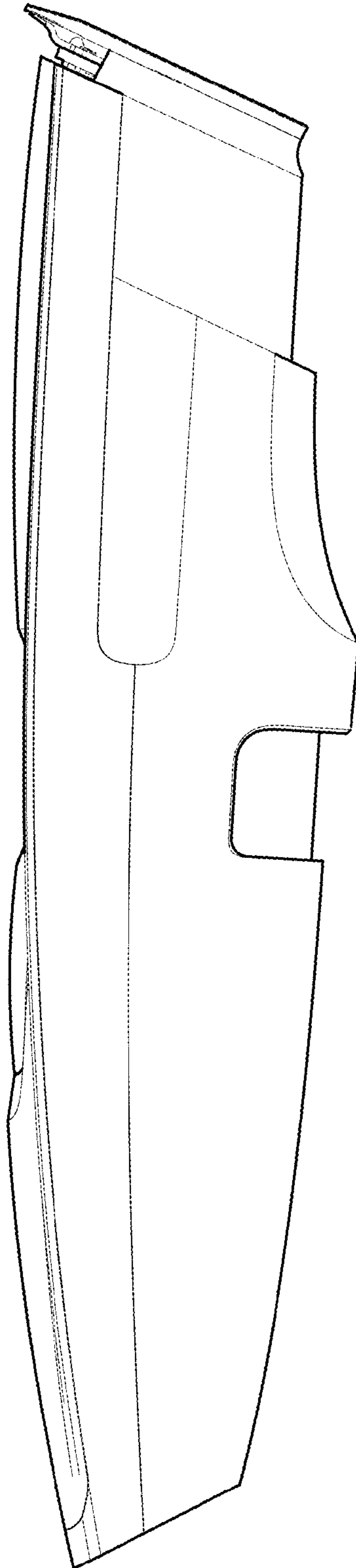

1.5

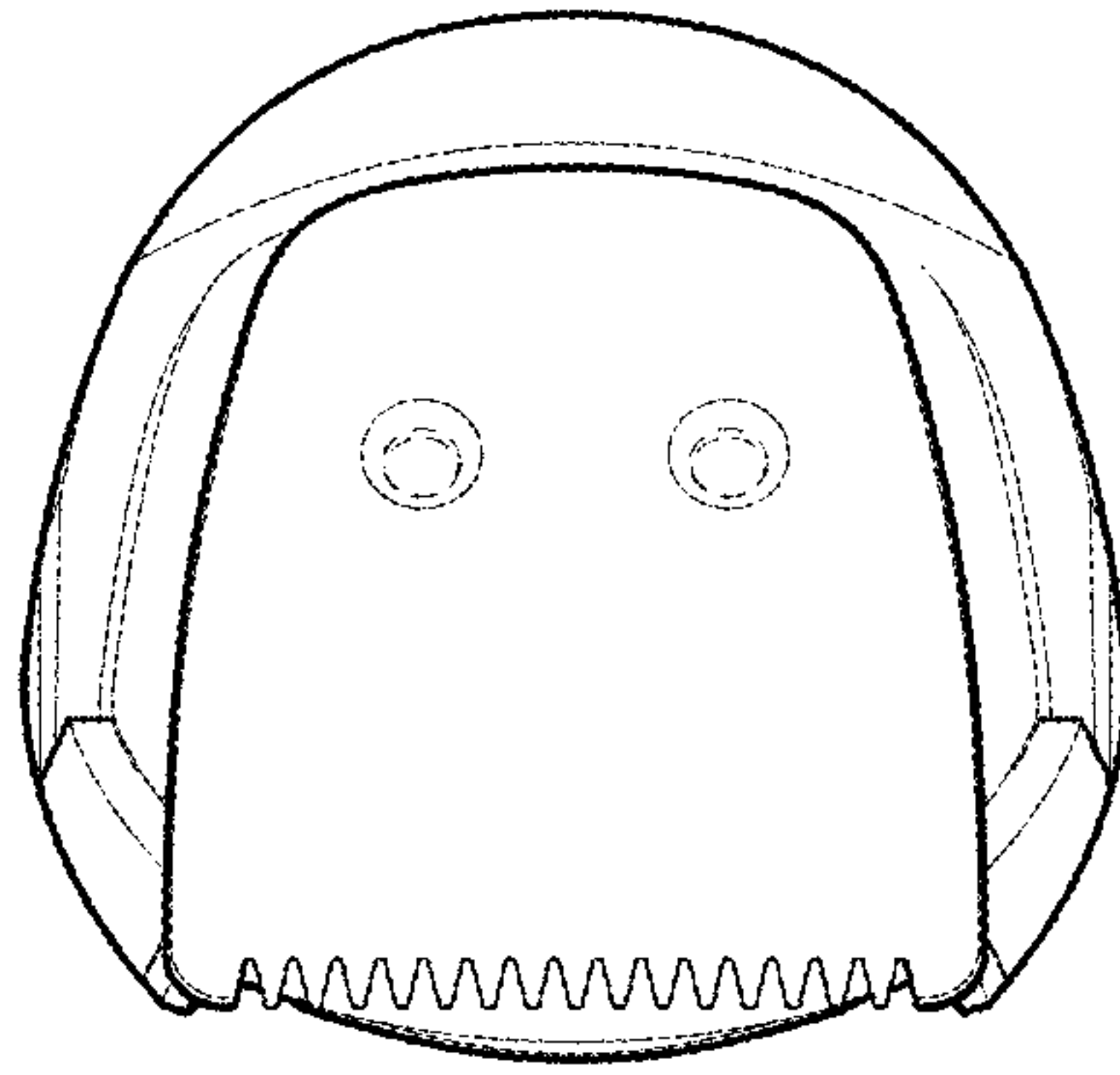

1.6

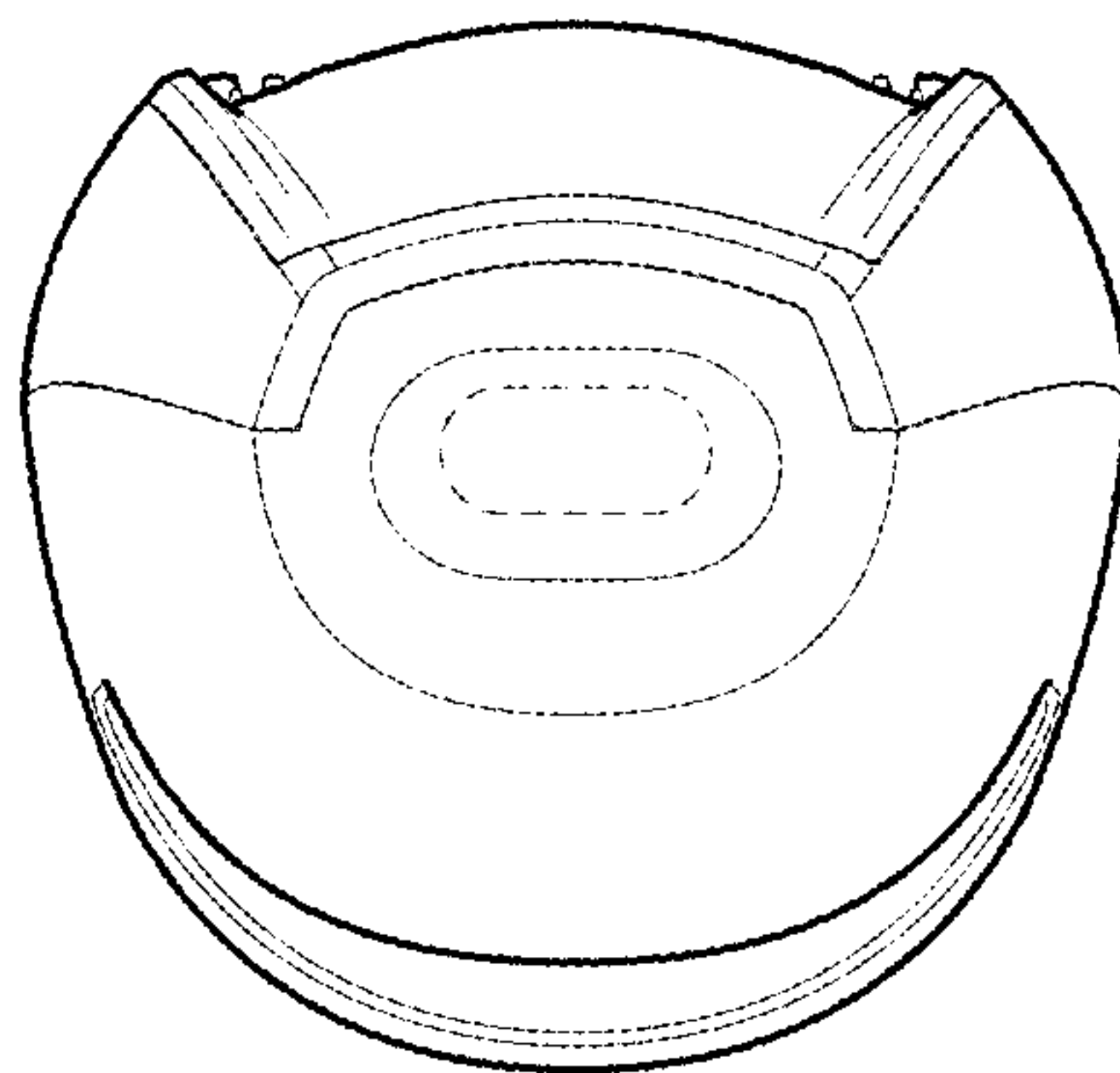

1.7