



US00D809058S

(12) **United States Design Patent**  
**Griswold**

(10) **Patent No.:** **US D809,058 S**

(45) **Date of Patent:** **\*\* Jan. 30, 2018**

(54) **THUMB STRAP FOR ATTACHMENT TO A MUSICAL PLECTRUM**

6,949,700 B1 \* 9/2005 Kelly ..... G10D 3/163  
84/320

7,977,557 B2 7/2011 Broderick

D713,281 S \* 9/2014 Chen ..... D11/3

D739,074 S \* 9/2015 Bennett ..... D27/136

(71) Applicant: **David Griswold**, Wilson, NC (US)

(72) Inventor: **David Griswold**, Wilson, NC (US)

(\*\*) Term: **15 Years**

(21) Appl. No.: **29/577,153**

(22) Filed: **Sep. 9, 2016**

(51) **LOC (11) Cl.** ..... **17-03**

(52) **U.S. Cl.**  
USPC ..... **D17/20**

(58) **Field of Classification Search**  
USPC .... D17/14, 20, 21, 23, 99; D11/1-3, 26-28,  
D11/37, 39; D8/32, 330, 331, 333, 319,  
D8/382, 394, 396

CPC .... G10D 13/003; G10D 13/006; G10D 13/02;  
G10D 13/024; G10D 3/00; G10D 3/003;  
G10D 3/163; G06F 17/30; A24F 13/22  
See application file for complete search history.

(56) **References Cited**

**U.S. PATENT DOCUMENTS**

1,557,476	A *	10/1925	Kimball	.....	G10D 3/163 84/322
D113,962	S *	3/1939	Brophy	.....	D11/26
2,453,190	A *	11/1948	Boscowitz	.....	A44C 9/0069 63/1.12
D158,249	S *	4/1950	Claffin	.....	132/330
4,879,940	A *	11/1989	Pereira	.....	G10D 3/163 84/322
D319,990	S *	9/1991	Berti	.....	D11/30
D393,362	S *	4/1998	Byers	.....	D17/20
6,626,598	B2 *	9/2003	Schneider	.....	B43K 23/012 401/258
6,797,871	B2	9/2004	Atkin		

**OTHER PUBLICATIONS**

Top Banana Antiques, Gold Signet Ring Vintage, circa 1980, [online], [site visited on Oct. 24, 2017]. Available from Internet, <URL: https://topbananaantiques.com/products/9k-9ct-gold-signet-ring-vintage-c1980-english-hallmark-size-uk-z-us-12-75> (Year: 1980).\*

\* cited by examiner

*Primary Examiner* — Sheryl Lane

*Assistant Examiner* — Samantha N Wood

(74) *Attorney, Agent, or Firm* — Quickpatents, LLC; Kevin Prince

(57) **CLAIM**

I claim the ornamental design for a thumb strap for attachment to a musical plectrum, as shown and described.

**DESCRIPTION**

FIG. 1 is a perspective view of a thumb strap for attachment to a musical plectrum, showing my new design in an exemplary environment;

FIG. 2 is an enlarged perspective view thereof;

FIG. 3 is a front elevational view of FIG. 2;

FIG. 4 is a rear elevational view of FIG. 2;

FIG. 5 is a left-side elevational view of FIG. 2;

FIG. 6 is a right-side elevational view of FIG. 2;

FIG. 7 is a top plan view of FIG. 2; and,

FIG. 8 is a bottom plan view of FIG. 2.

The broken lines show environmental subject matter and form no part of the claimed design.

**1 Claim, 5 Drawing Sheets**

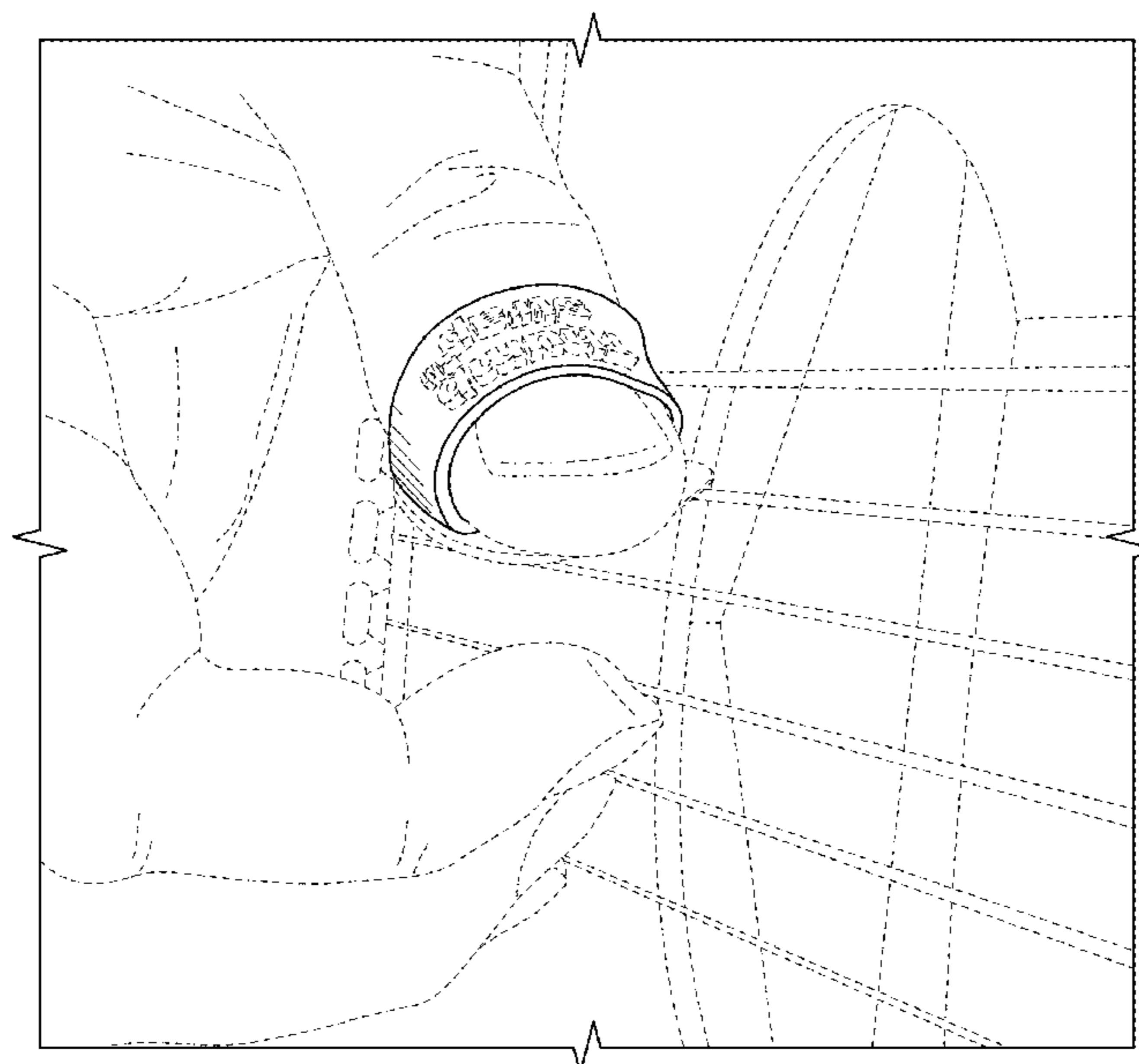

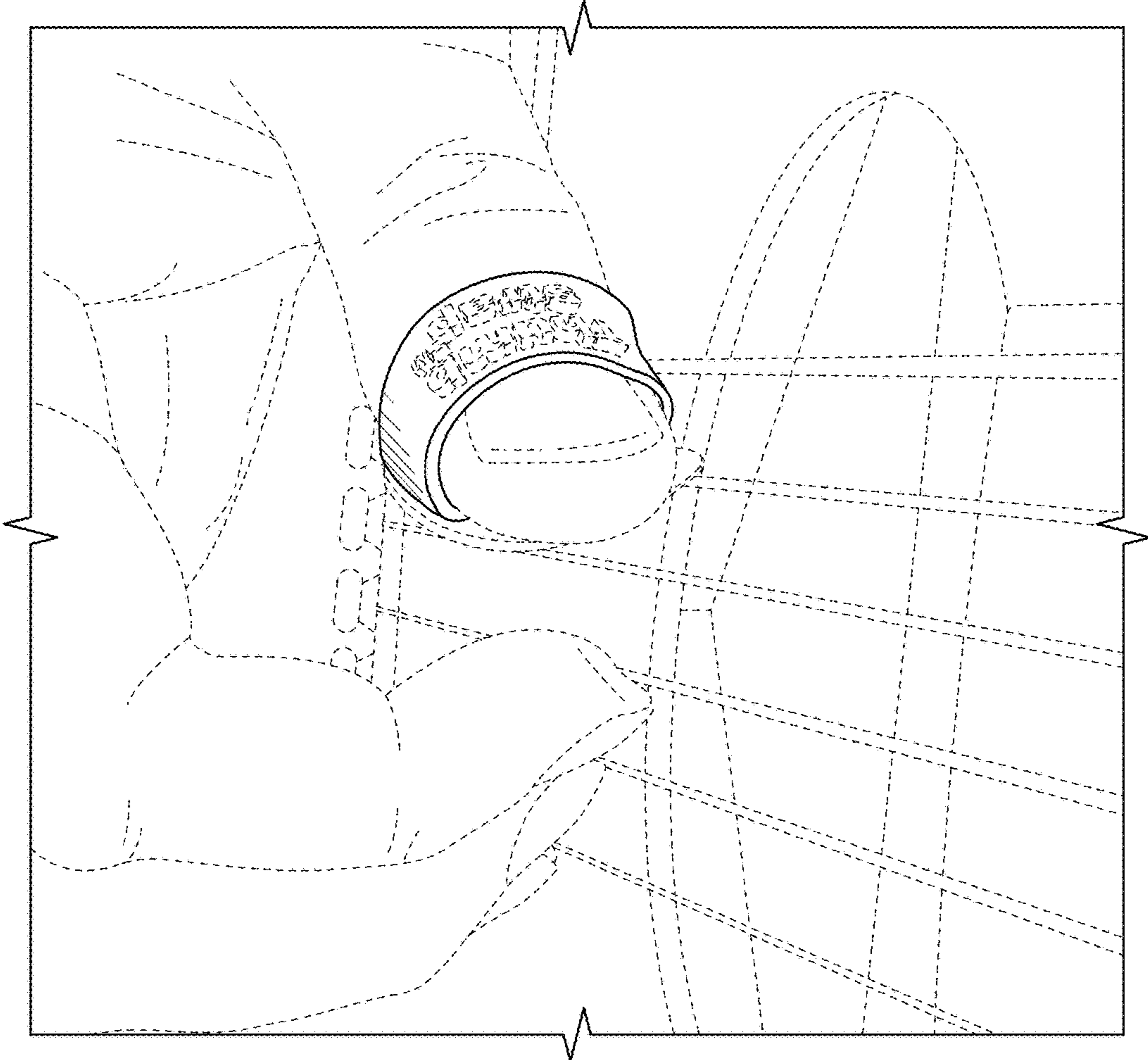

FIG. 1

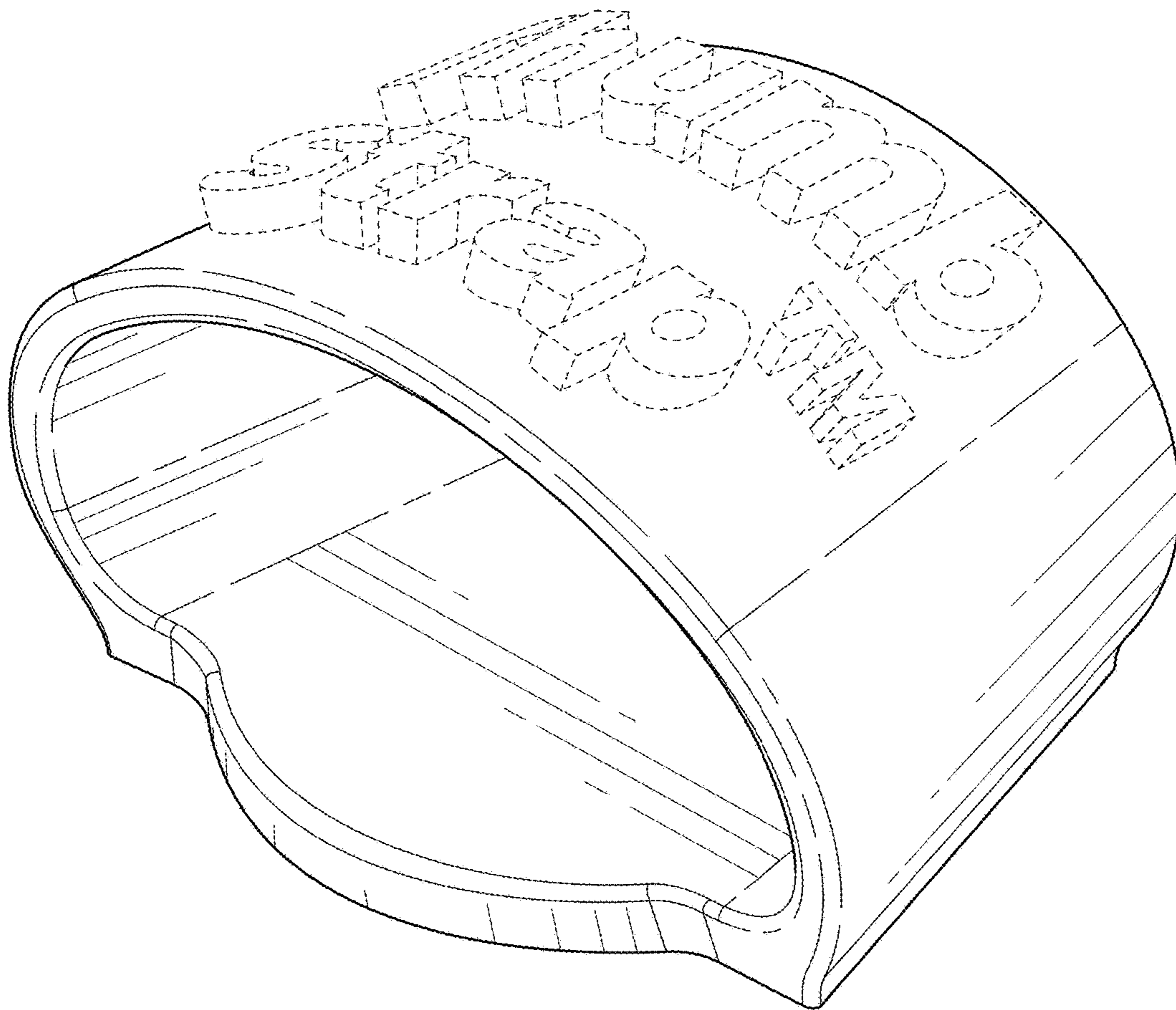

FIG. 2

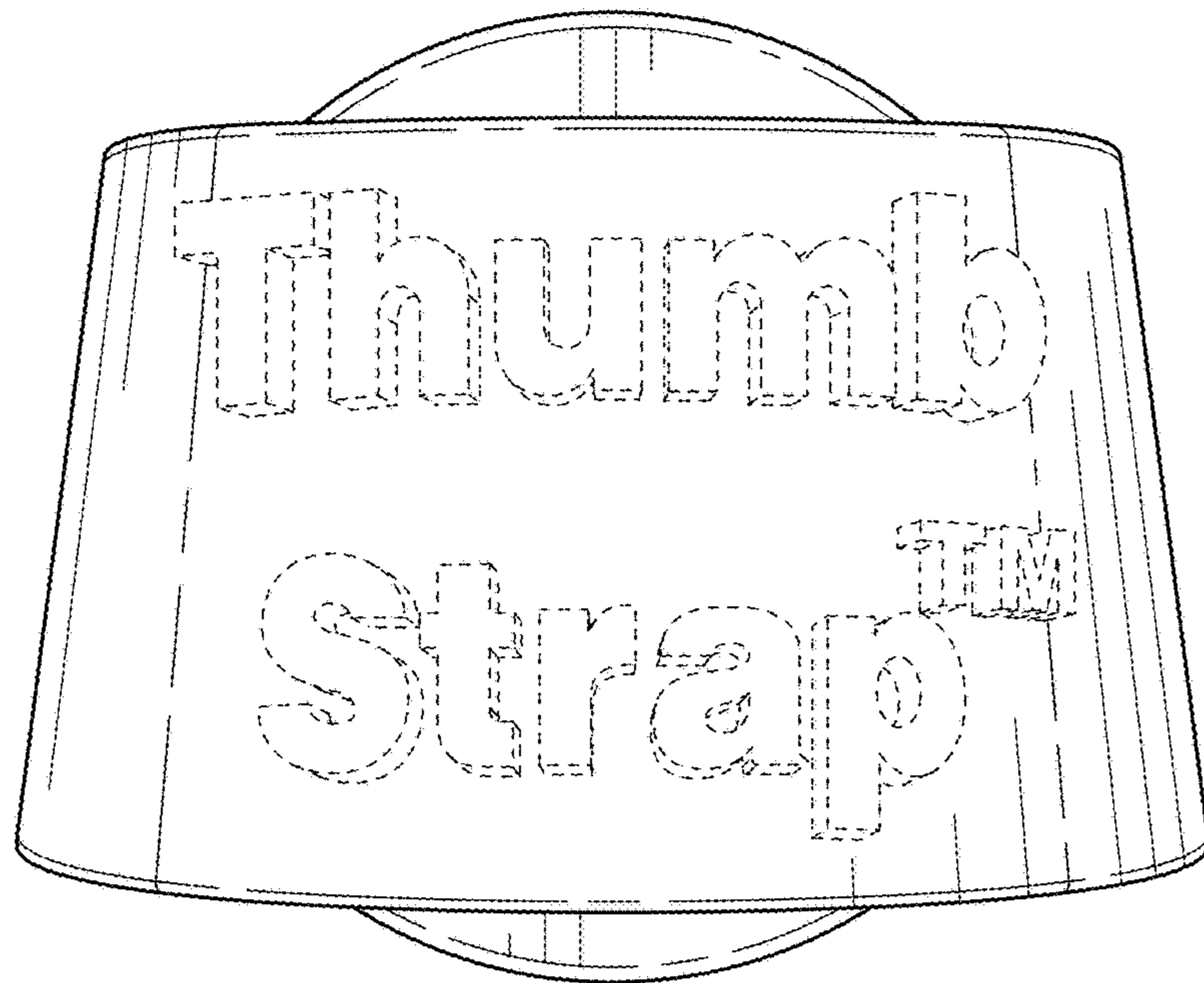

FIG. 3

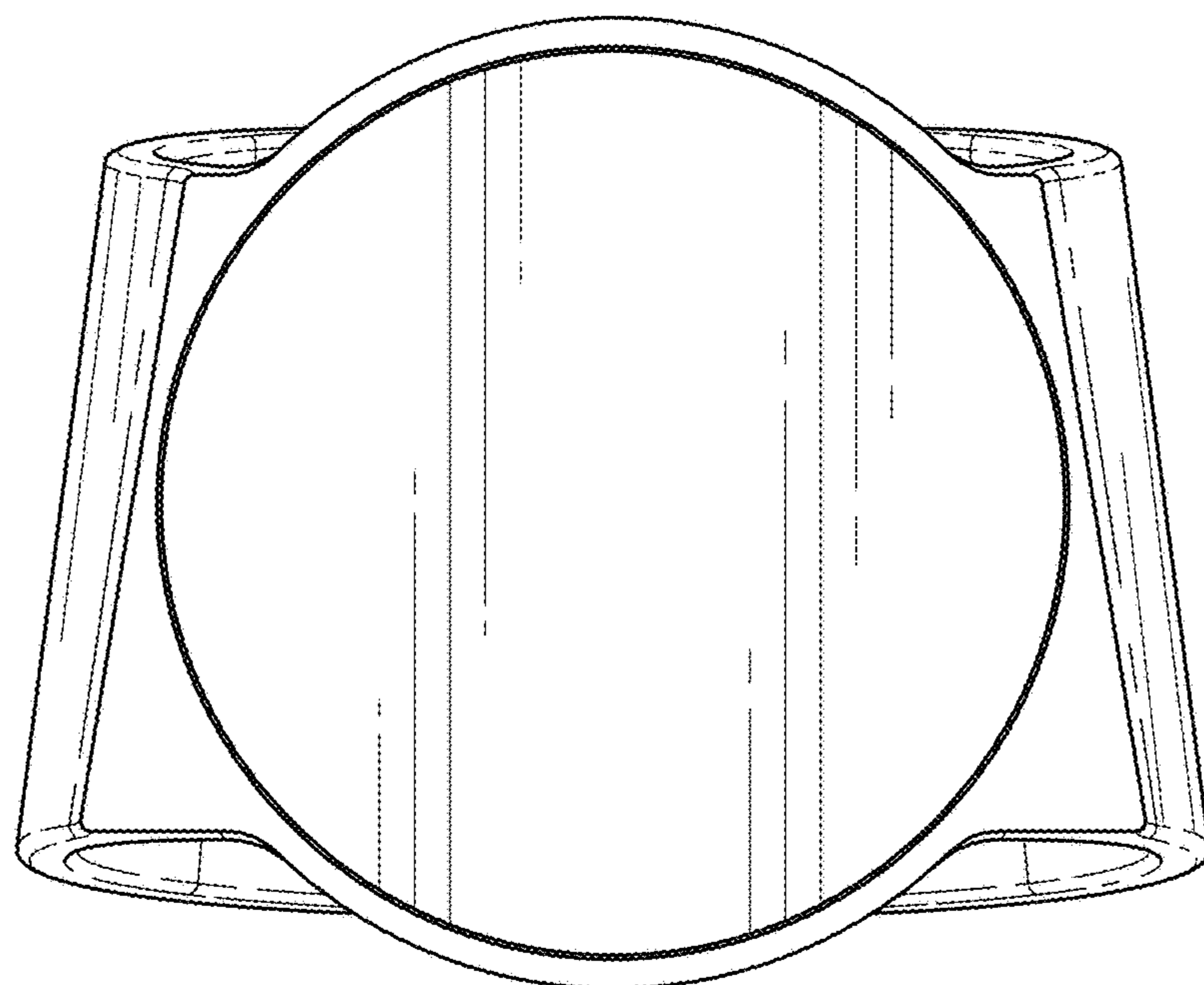

FIG. 4

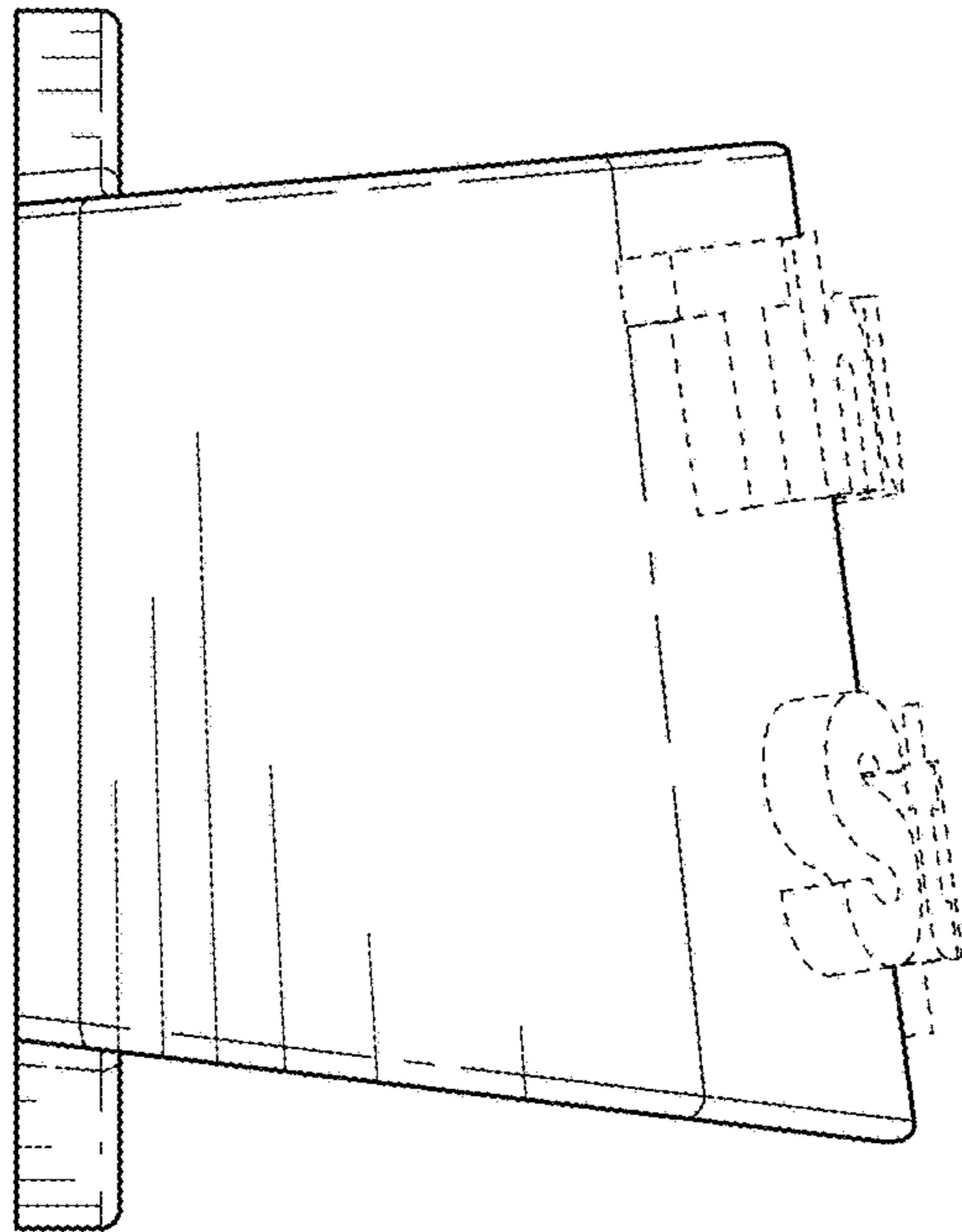

FIG. 5

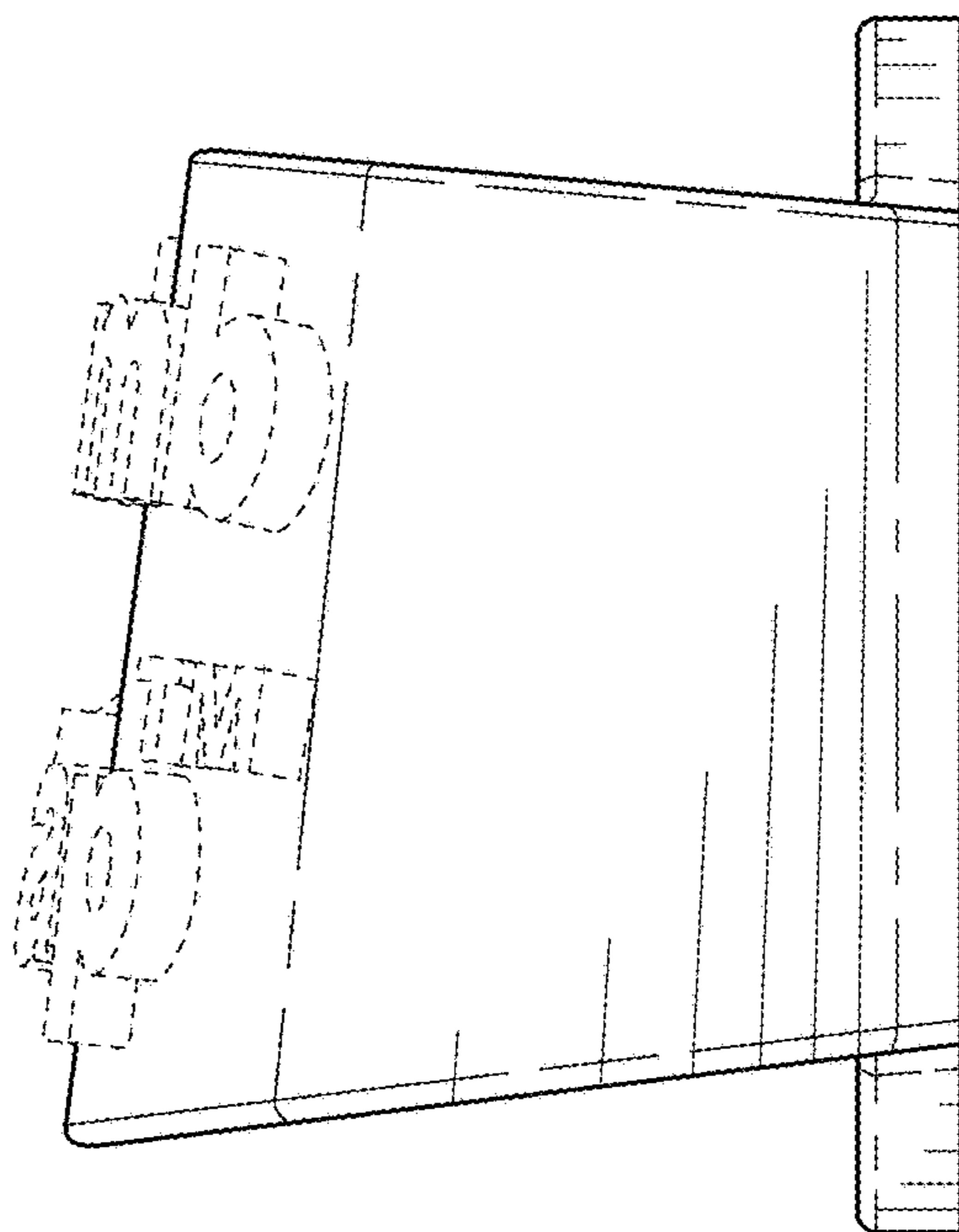

FIG. 6

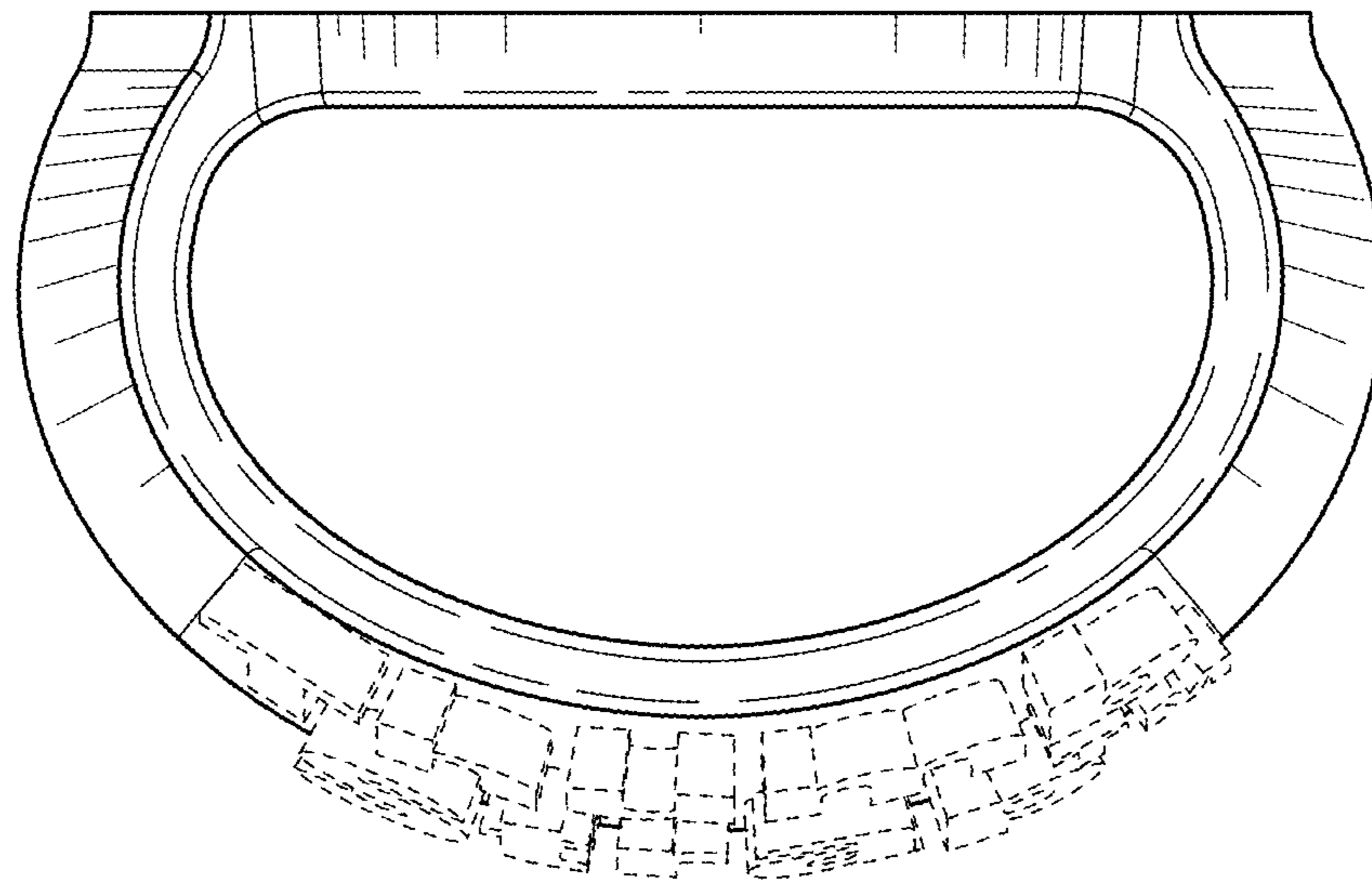

FIG. 7

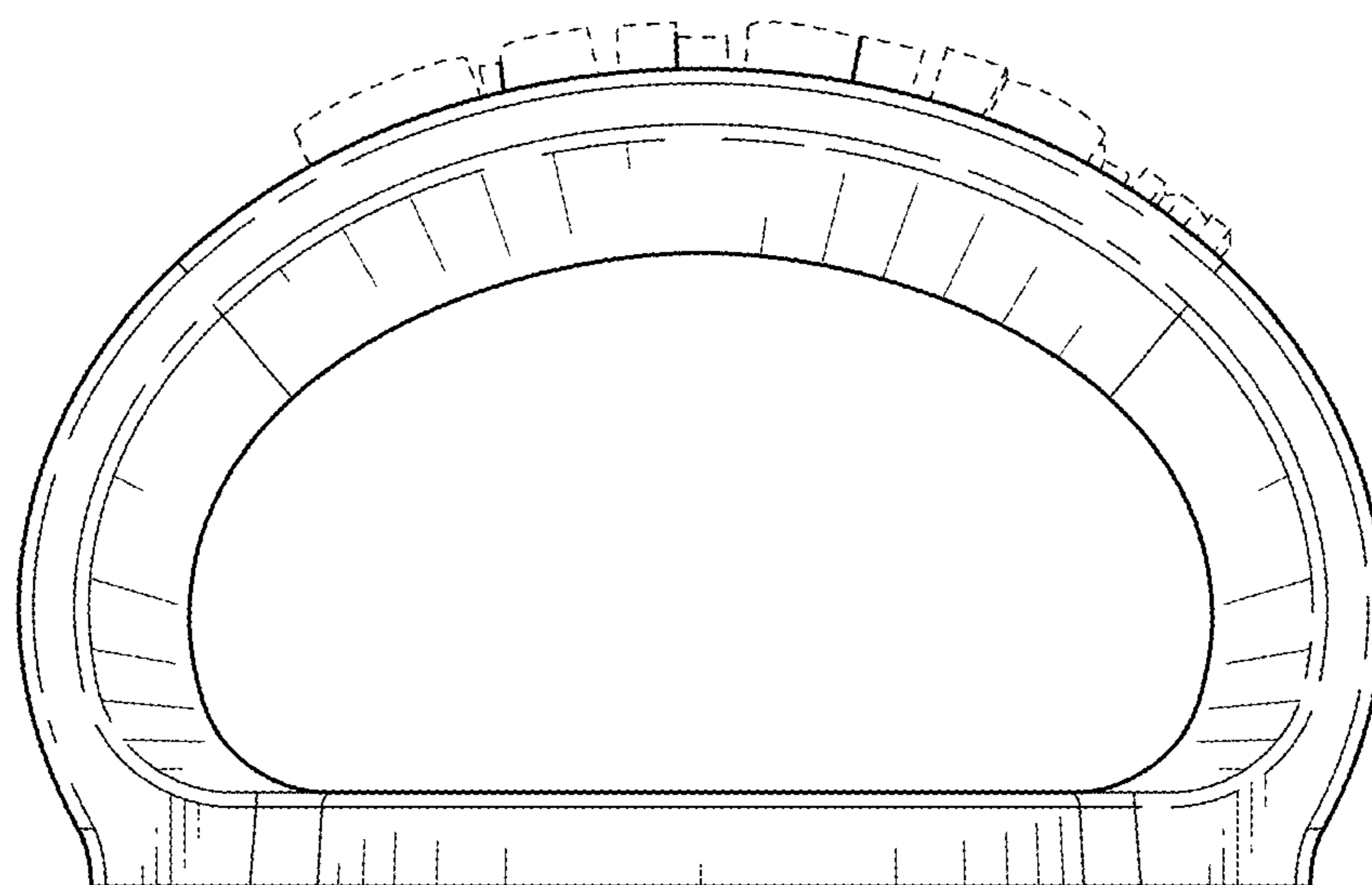

FIG. 8