



US00D808901S

(12) **United States Design Patent** (10) **Patent No.:** **US D808,901 S**  
**Kelly et al.** (45) **Date of Patent:** **\*\* Jan. 30, 2018**

(54) **CHARGING BASE**

(71) Applicant: **Meemoobaby Ltd.**, Teddington  
(Middlesex) (GB)

(72) Inventors: **Julia Kelly**, Teddington (GB); **Jo Barnard**, London (GB); **Andrew Cliff**, London (GB)

(73) Assignee: **Meemoobaby Ltd.**, Teddington  
(Middlesex) (GB)

(\*\*) Term: **15 Years**

(21) Appl. No.: **29/563,205**

(22) Filed: **May 3, 2016**

(51) **LOC (11) Cl.** ..... **13-02**

(52) **U.S. Cl.**  
USPC ..... **D13/107**

(58) **Field of Classification Search**  
USPC ..... D13/107-110, 118, 119, 184; D14/251,  
D14/253, 432, 434  
CPC ..... Y02E 60/12; Y02T 90/14; Y02T 90/122;  
Y02T 90/128; Y02T 90/163; H02J 7/025;  
H02J 7/0042; H02J 7/0044; H02J 7/0045;  
H02J 7/0003; H01F 38/14; H01R  
13/6675; H01M 2/1022; H01M 2/1055;  
H01M 10/44; H01M 10/46; H01M  
10/425; B60L 11/182  
See application file for complete search history.

D666,575 S \* 9/2012 Marsh ..... D14/159  
8,299,750 B2 \* 10/2012 Pai ..... H02J 7/0044  
320/107  
D704,177 S \* 5/2014 Chun ..... D14/240  
D724,060 S \* 3/2015 Ahn ..... D14/218  
D731,996 S \* 6/2015 Border ..... D14/150  
D742,823 S \* 11/2015 Nitz ..... D13/103  
D746,269 S \* 12/2015 Chen ..... D14/227  
D757,014 S \* 5/2016 Hahn ..... D13/108  
D772,813 S \* 11/2016 Wahl ..... D13/108  
D777,103 S \* 1/2017 Park ..... D13/108

FOREIGN PATENT DOCUMENTS

GB 2525597 A 11/2015  
WO 20150166201 A1 11/2015

\* cited by examiner

*Primary Examiner* — Rosemary K Tarcza  
*Assistant Examiner* — Alison M Ofstun  
 (74) *Attorney, Agent, or Firm* — Thomas | Horstemeyer,  
 LLP

(57) **CLAIM**

The ornamental design for a charging base, as shown and described.

**DESCRIPTION**

FIG. 1 is a perspective view of our new charging base;  
 FIG. 2 is a top view of our new charging base of FIG. 1;  
 FIG. 3 is a side view of our new charging base of FIG. 1, the  
 opposite side view being a mirror image thereof;  
 FIG. 4 is another side view of our new charging base of FIG.  
 1;  
 FIG. 5 is a side view of our new charging base, opposite that  
 of FIG. 4; and,  
 FIG. 6 is a bottom view of our new charging base.  
 The broken lines are shown for the purpose of illustrating  
 portions of the article that form no part of the claimed  
 design.

**1 Claim, 6 Drawing Sheets**

(56) **References Cited**

U.S. PATENT DOCUMENTS

D342,718 S \* 12/1993 Mackay ..... D13/108  
 D512,417 S \* 12/2005 Hirakawa ..... D14/223  
 7,443,136 B2 \* 10/2008 Tsukamoto ..... H01M 10/659  
 320/112  
 D605,305 S \* 12/2009 Carter ..... D24/231  
 D618,121 S \* 6/2010 Penix ..... D10/106.9  
 D659,093 S \* 5/2012 Schmid ..... D13/108

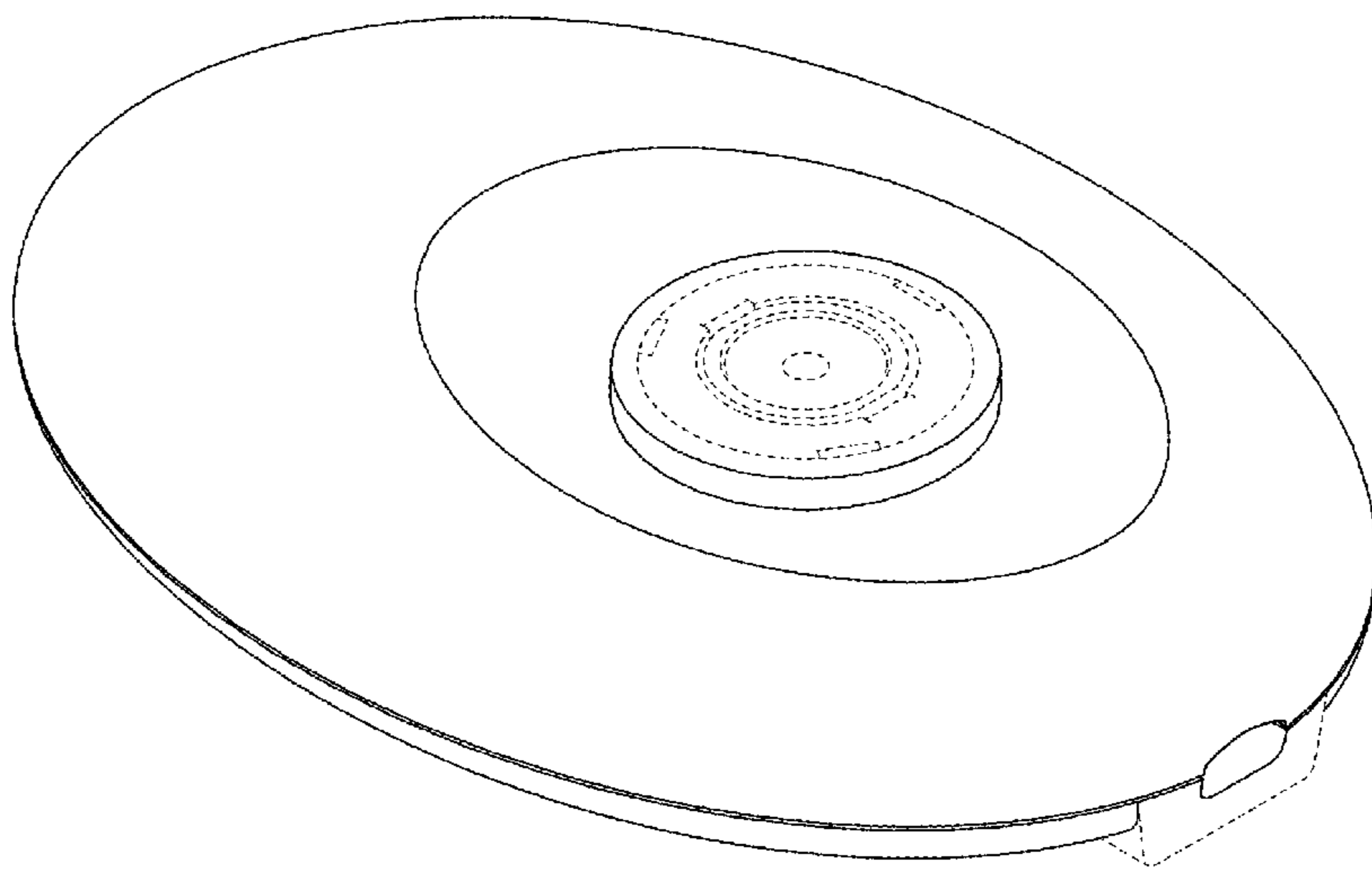

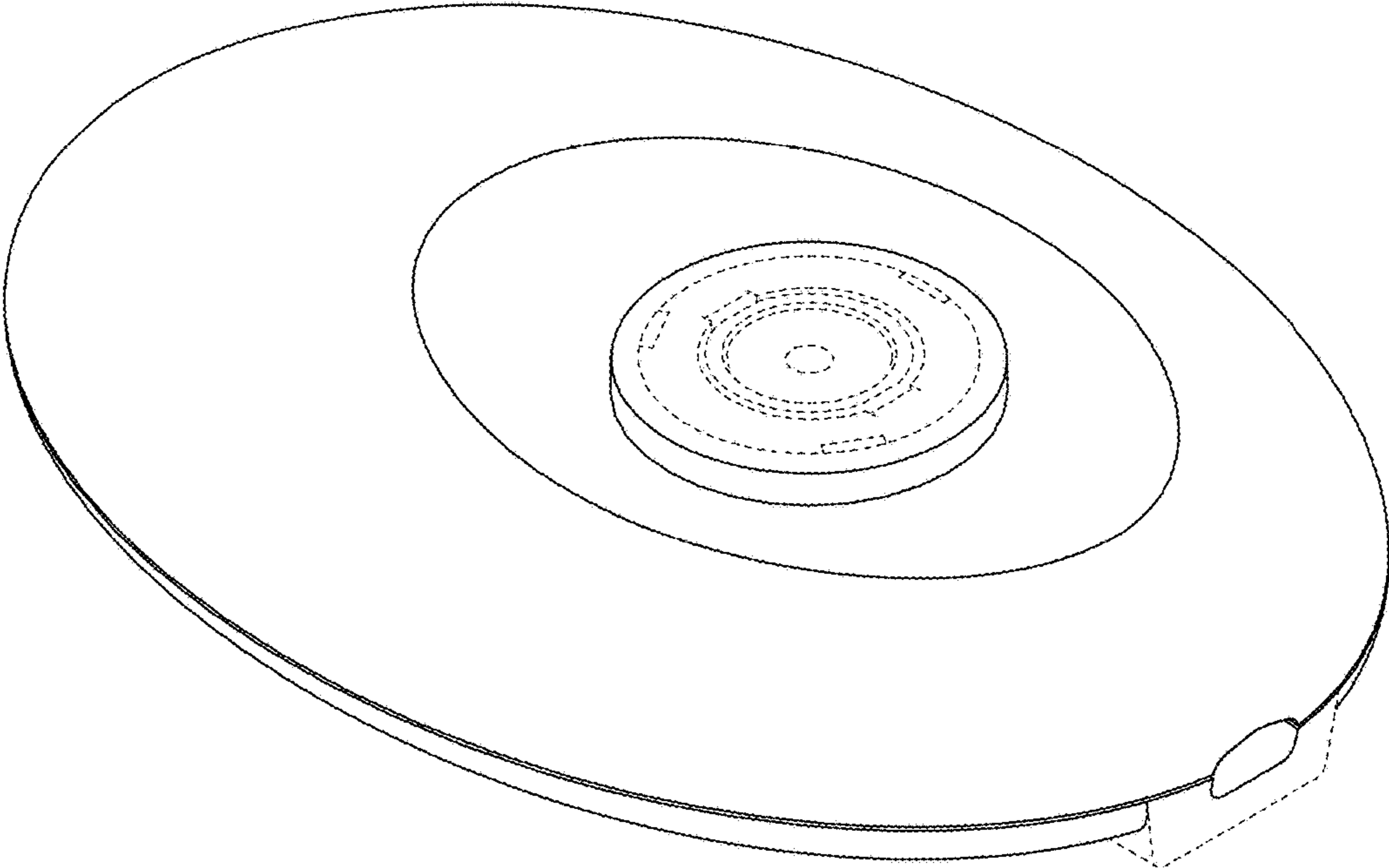

FIG. 1

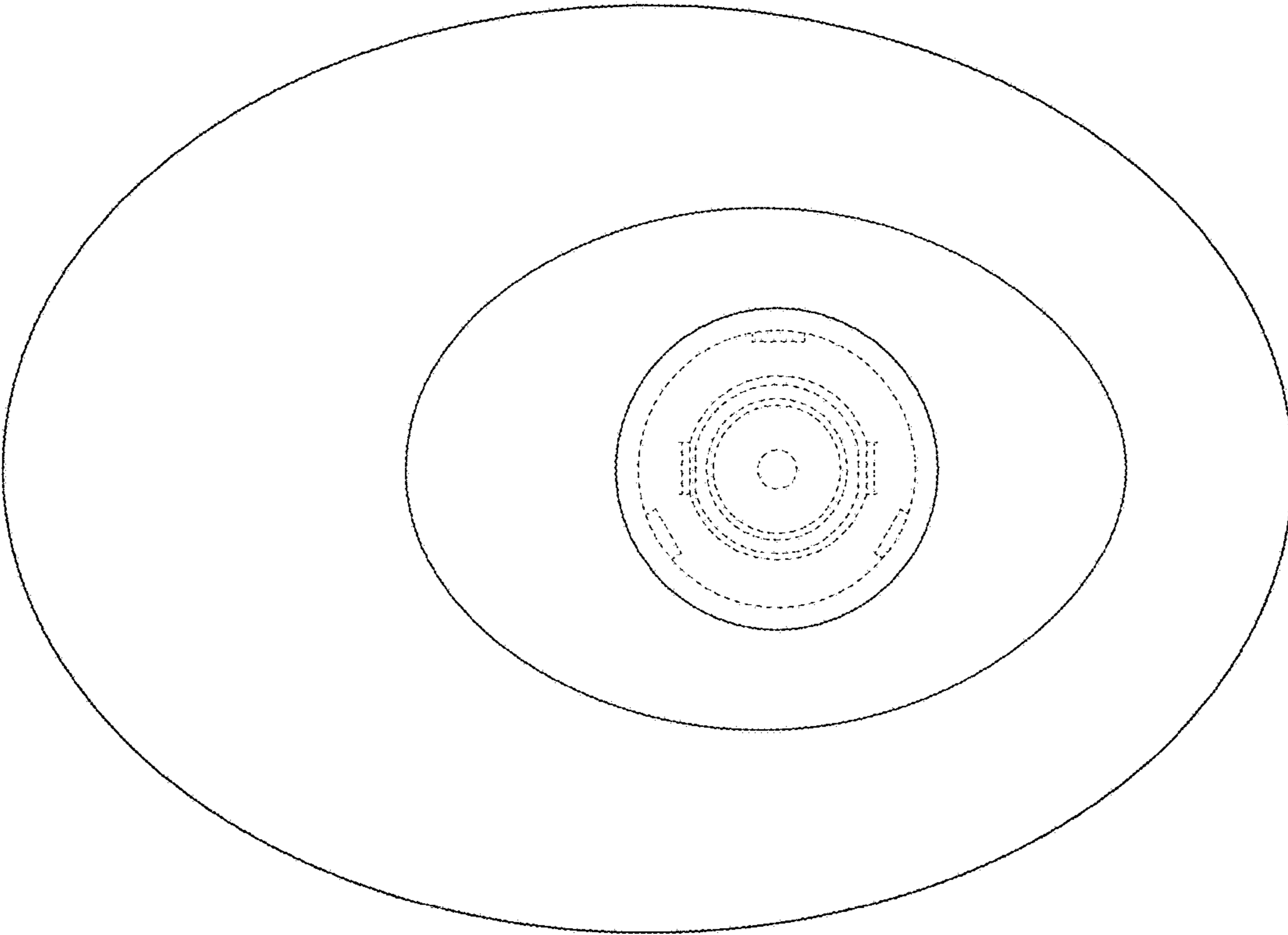

FIG. 2

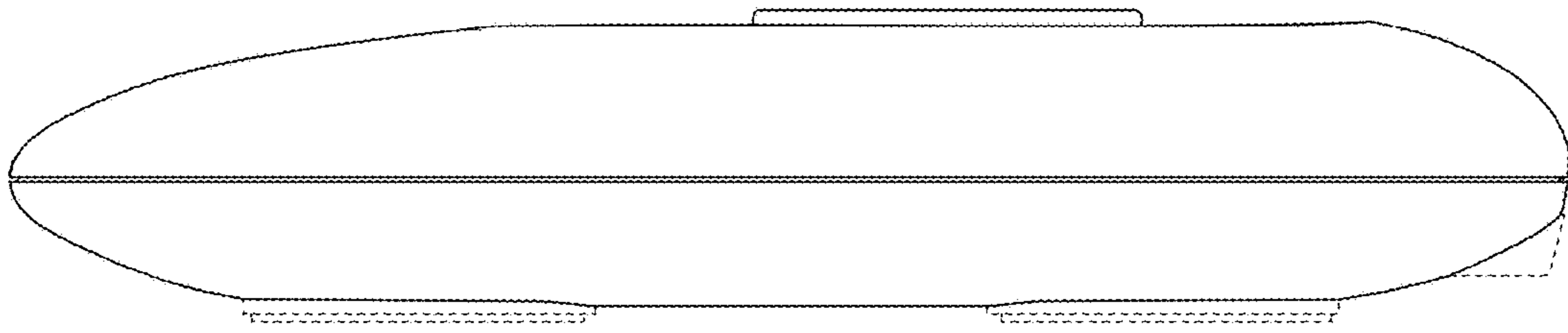

FIG. 3

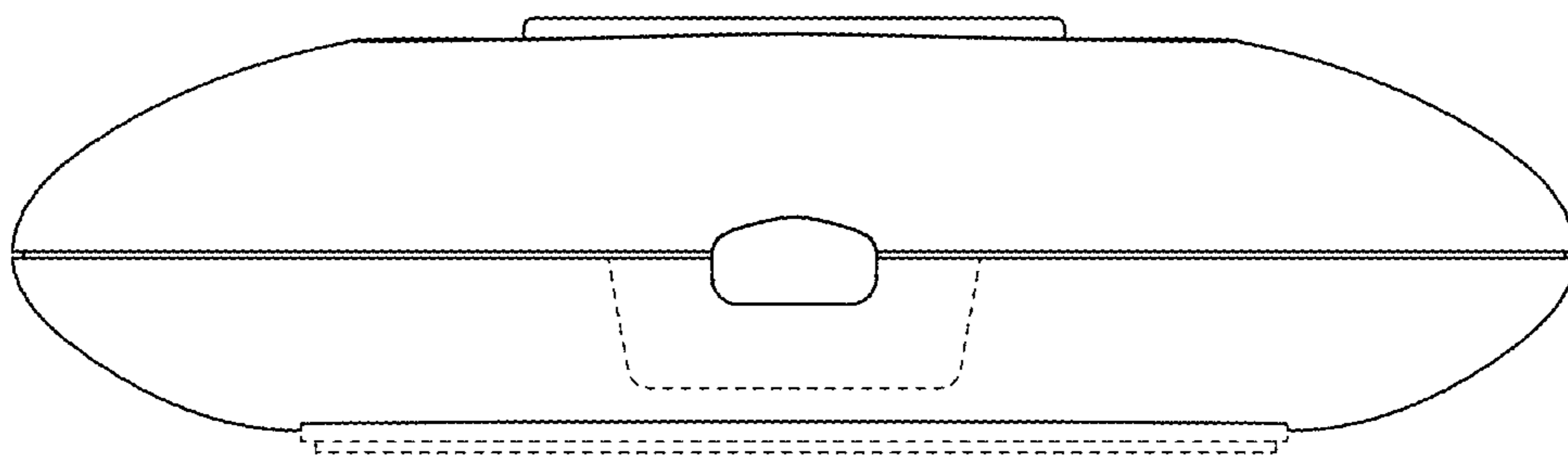

FIG. 4

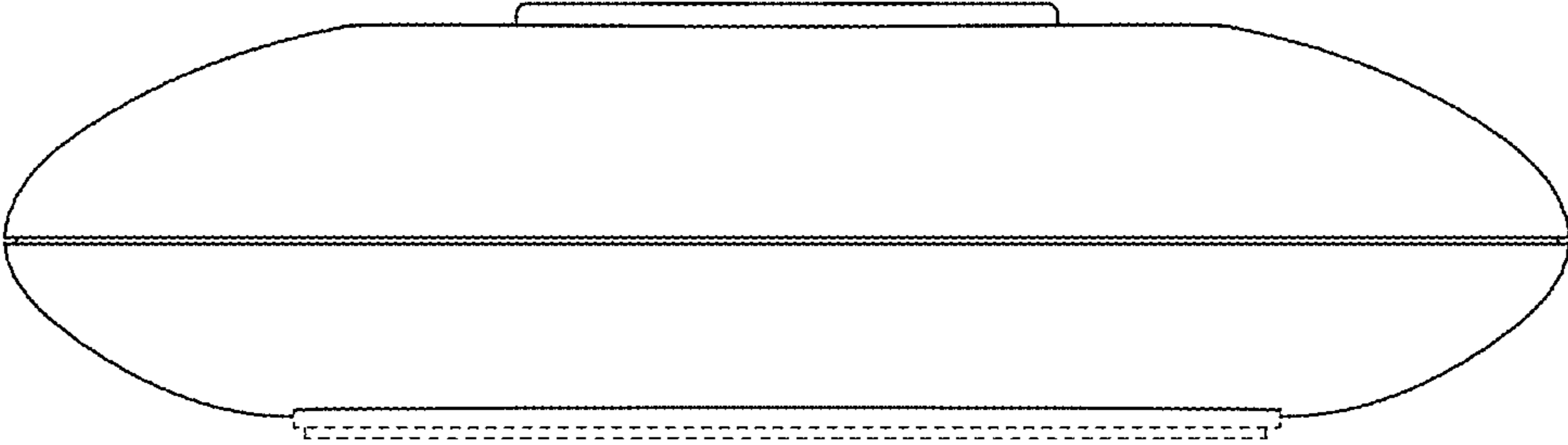

FIG. 5

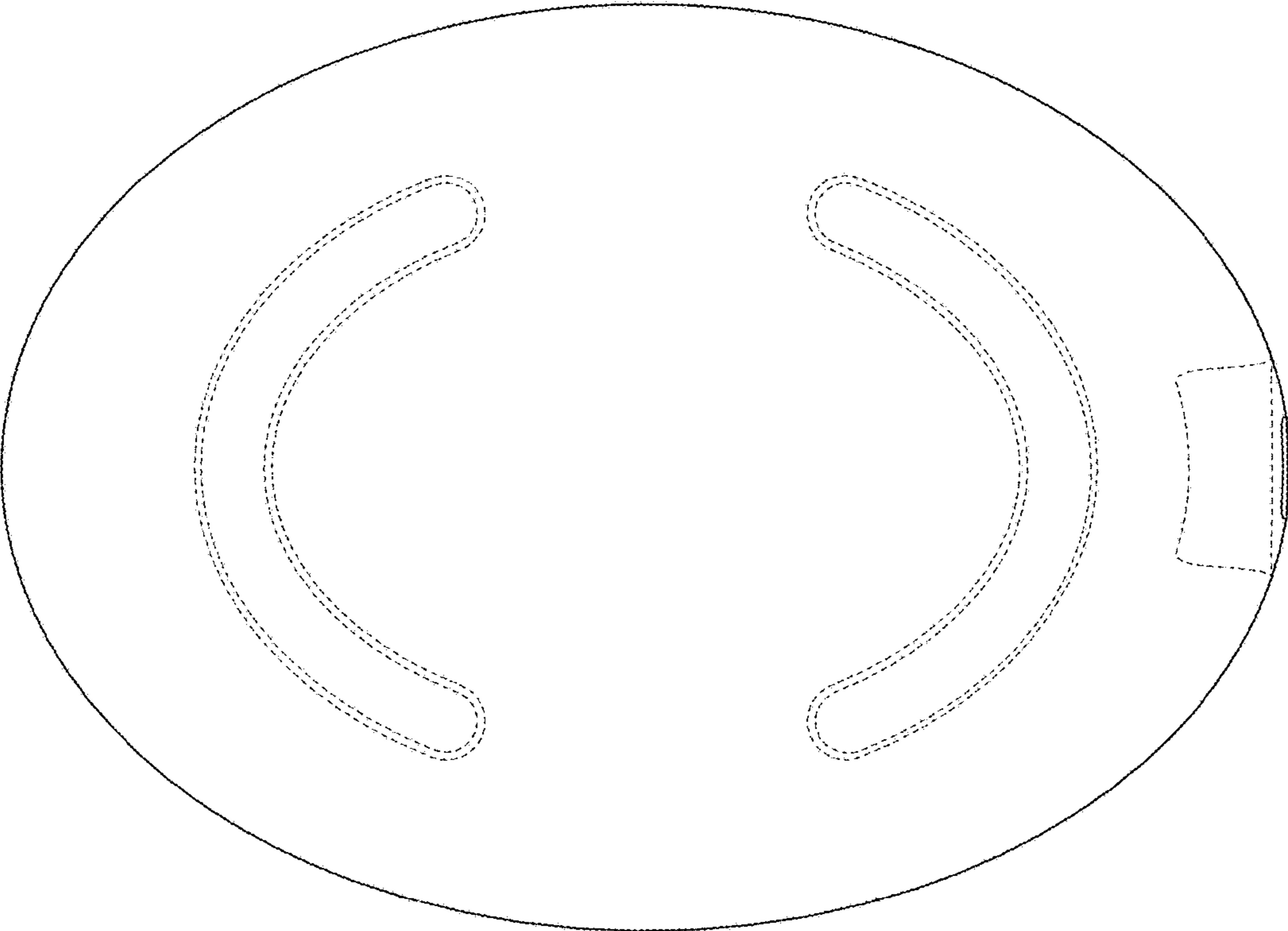

FIG. 6