



US00D808720S

(12) **United States Design Patent**
Dinan

(10) **Patent No.:** **US D808,720 S**

(45) **Date of Patent:** **** Jan. 30, 2018**

- (54) **FRUIT INFUSION STRAINING DRINKING BOTTLE**
- (71) Applicant: **Lauren Ashleigh Dinan**, La Jolla, CA (US)
- (72) Inventor: **Lauren Ashleigh Dinan**, La Jolla, CA (US)
- (**) Term: **15 Years**
- (21) Appl. No.: **29/589,086**
- (22) Filed: **Dec. 28, 2016**
- (51) **LOC (11) Cl.** **07-01**
- (52) **U.S. Cl.**
USPC **D7/507; D7/510; D7/532**
- (58) **Field of Classification Search**
USPC D7/507, 509, 510, 511, 523, 529, 530, D7/531, 532, 533, 536, 608, 598, 300.1, D7/320, 629, 392.1, 396.2, 396.6, 387, D7/667; D9/435, 436, 443, 452, 453, D9/447, 440, 503; 220/592.16, 592.17, 220/705, 495.03; 215/381; D3/202
CPC A47G 19/22; A47G 19/2205; A47G 19/2211; A47G 19/2266; A47G 19/2272; A45F 3/16; B65D 47/066
See application file for complete search history.

- D651,853 S * 1/2012 Eyal D7/510
- D652,682 S * 1/2012 Eyal D7/510
- 8,215,511 B1 * 7/2012 Lin B65D 39/08
215/228
- D671,787 S * 12/2012 Lin D7/300.1
- D680,431 S * 4/2013 Hopkins D9/443
- 8,541,039 B2 9/2013 Lackey 426/394
- D700,060 S * 2/2014 Trevisan D9/688
- D708,954 S * 7/2014 Barnes D7/511
- D728,315 S * 5/2015 Bo D7/511
- 9,089,239 B2 7/2015 Billadeau
- D739,240 S * 9/2015 Satterfield D7/396.2
- D759,902 S * 6/2016 Kim D29/125
- 9,516,974 B2 * 12/2016 Herling A47J 31/18
- D779,323 S * 2/2017 Masrour D9/443
- D782,413 S * 3/2017 Tsui D13/108

(Continued)

Primary Examiner — Marianne Pandozzi
Assistant Examiner — Jae Liang
 (74) *Attorney, Agent, or Firm* — Petock & Petock, LLC;
 Douglas J. Petock

(57) **CLAIM**

I claim the ornamental design for a fruit infusion straining drinking bottle, as shown and described.

DESCRIPTION

FIG. 1 is a view in perspective of a fruit infusion straining drinking bottle;
 FIG. 2 is an exploded view in perspective thereof;
 FIG. 3 is a right side view thereof;
 FIG. 4 is a front side view thereof;
 FIG. 5 is a left side view thereof;
 FIG. 6 is a back side view thereof;
 FIG. 7 is a top view thereof; and,
 FIG. 8 is a bottom view thereof.
 Fruit and herbs may be placed into the bottle. The bottle is filled with water. The user then drinks fruit and herb infused water thru the bottle.

1 Claim, 5 Drawing Sheets

(56) **References Cited**

U.S. PATENT DOCUMENTS

- D31,043 S * 6/1899 Smith D7/409
- 3,040,897 A 6/1962 Holman 210/244
- 3,102,465 A 9/1963 Montesa 99/323
- 5,952,028 A 9/1999 Lesser 426/433
- D525,118 S * 7/2006 Mentasti D9/415
- D616,743 S * 6/2010 Cresswell D9/443
- D627,602 S * 11/2010 Eyal D7/510
- D628,486 S * 12/2010 Lane D7/510
- D635,457 S * 4/2011 Lane D7/510
- D639,663 S * 6/2011 Llerena D9/504

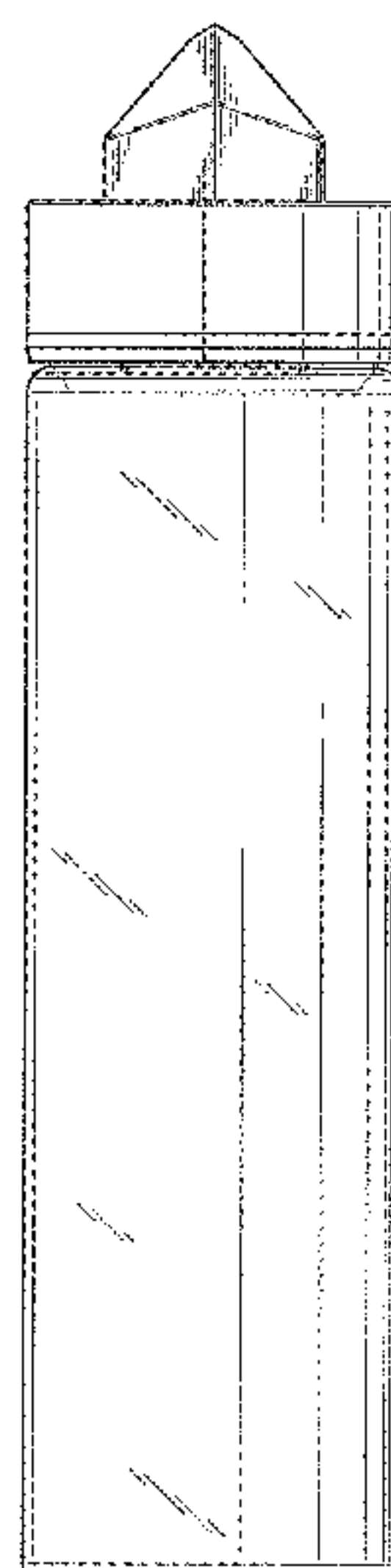
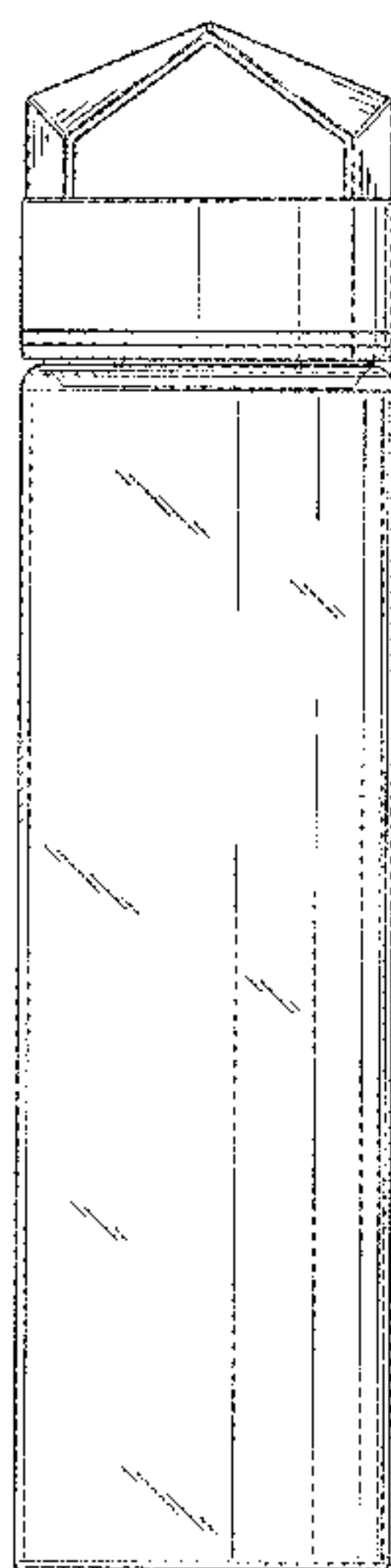

(56)

References Cited

U.S. PATENT DOCUMENTS

2005/0199129	A1	9/2005	Glucksman	426/79
2007/0131120	A1	6/2007	Hubbard	99/279
2010/0037781	A1	2/2010	Pas et al.	99/279
2010/0224078	A1	9/2010	Khalifa	99/323
2014/0044837	A1	2/2014	Weisman et al.	426/79
2014/0224725	A1	8/2014	Uspenski et al.	210/444

* cited by examiner

FIG. 1

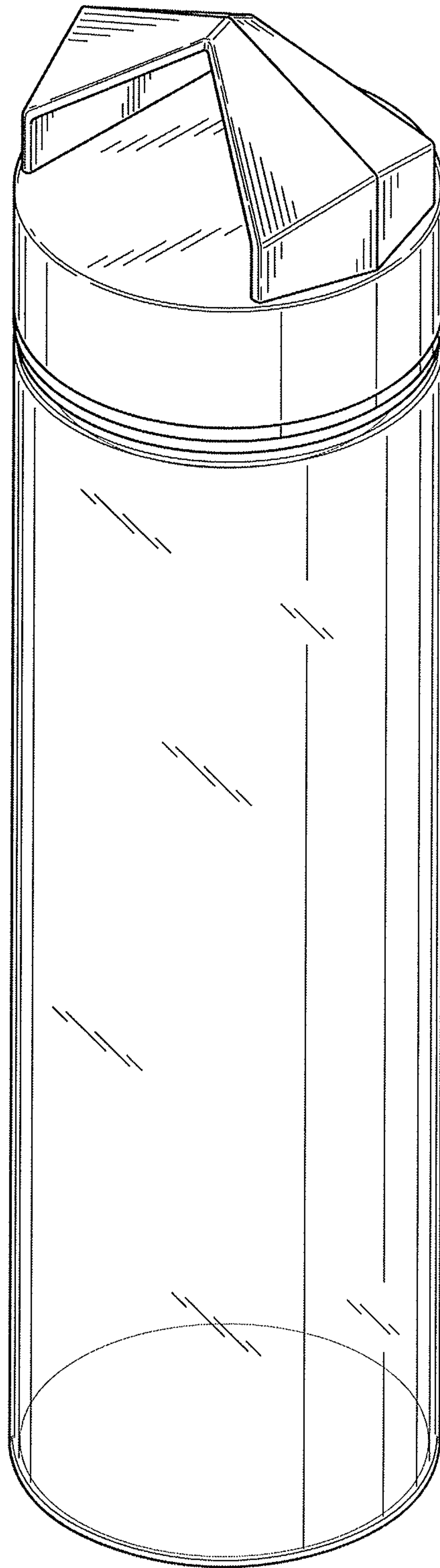

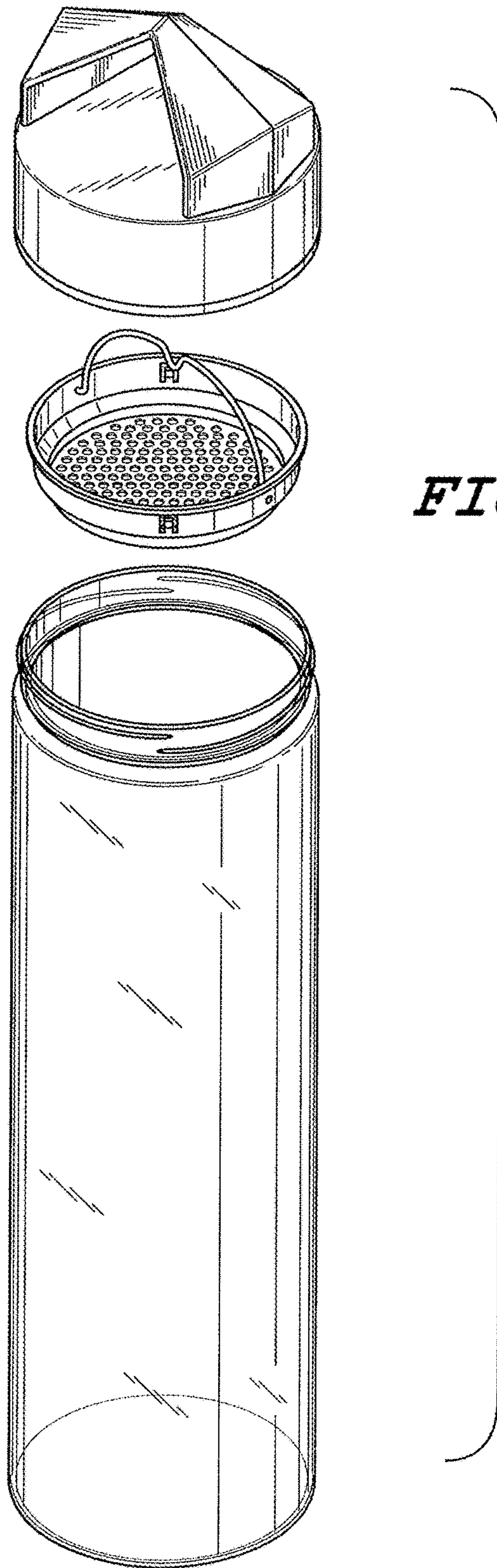

FIG. 2

FIG. 3

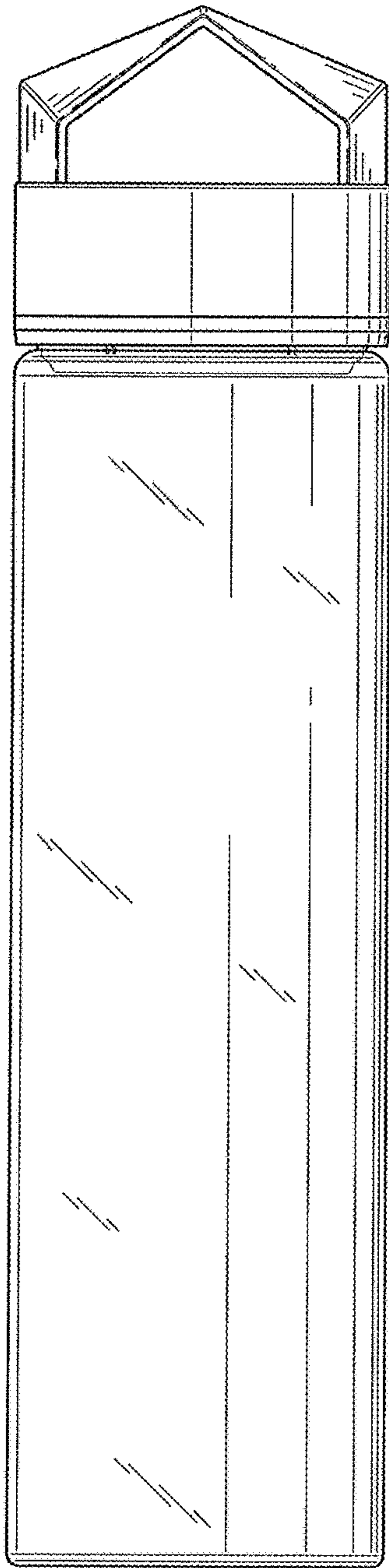

FIG. 4

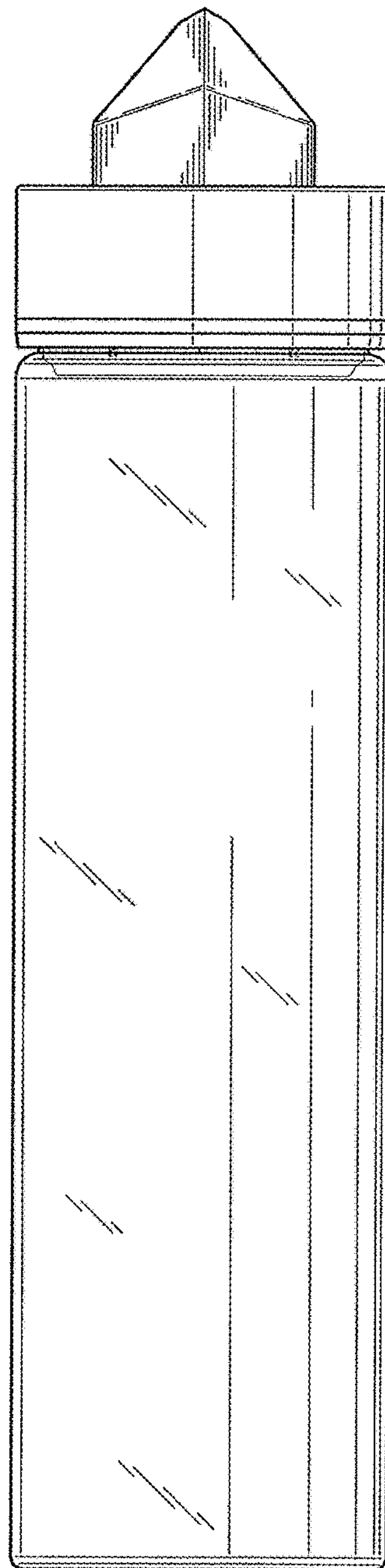

FIG. 5

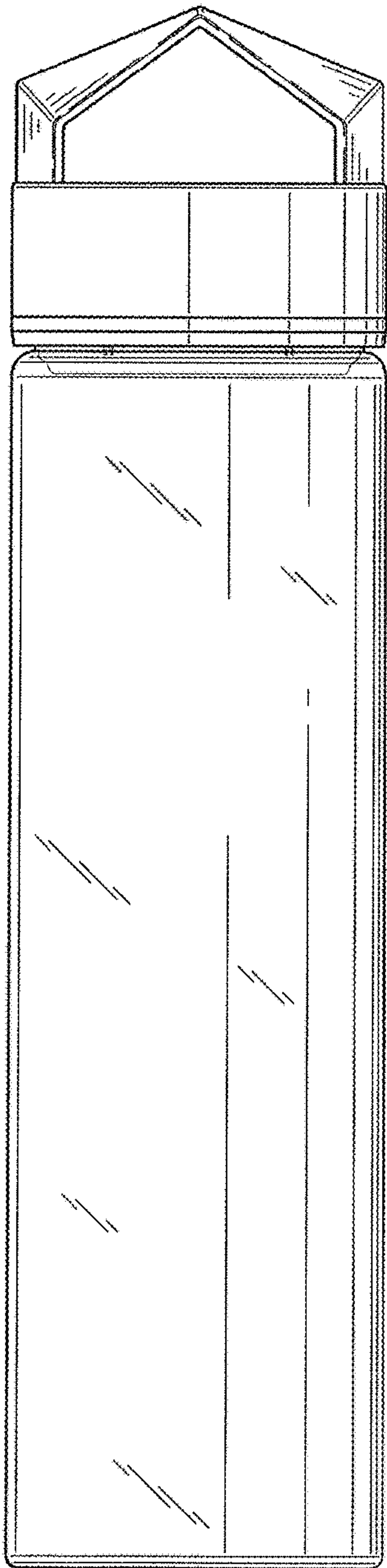

FIG. 6

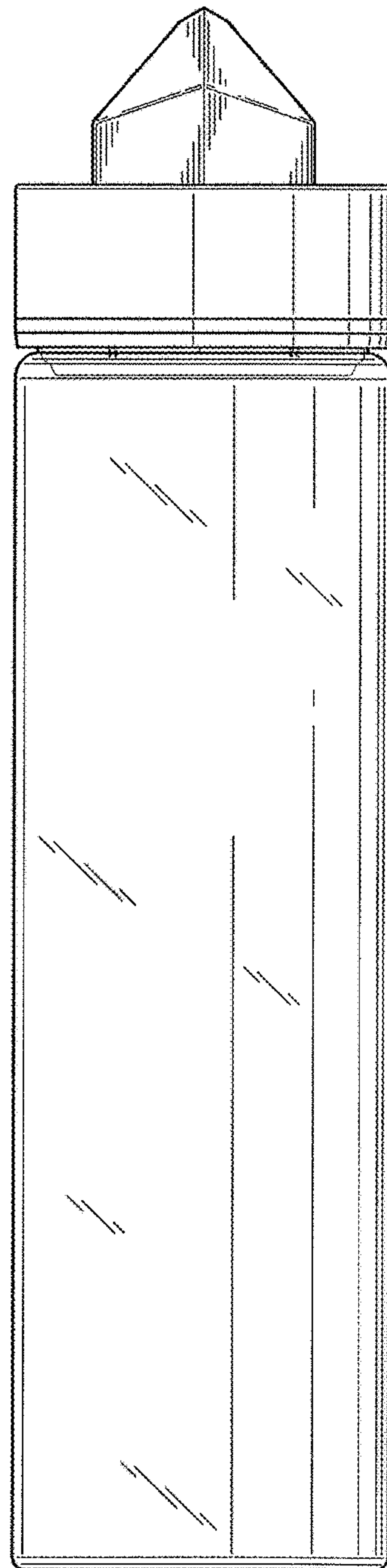

FIG. 7

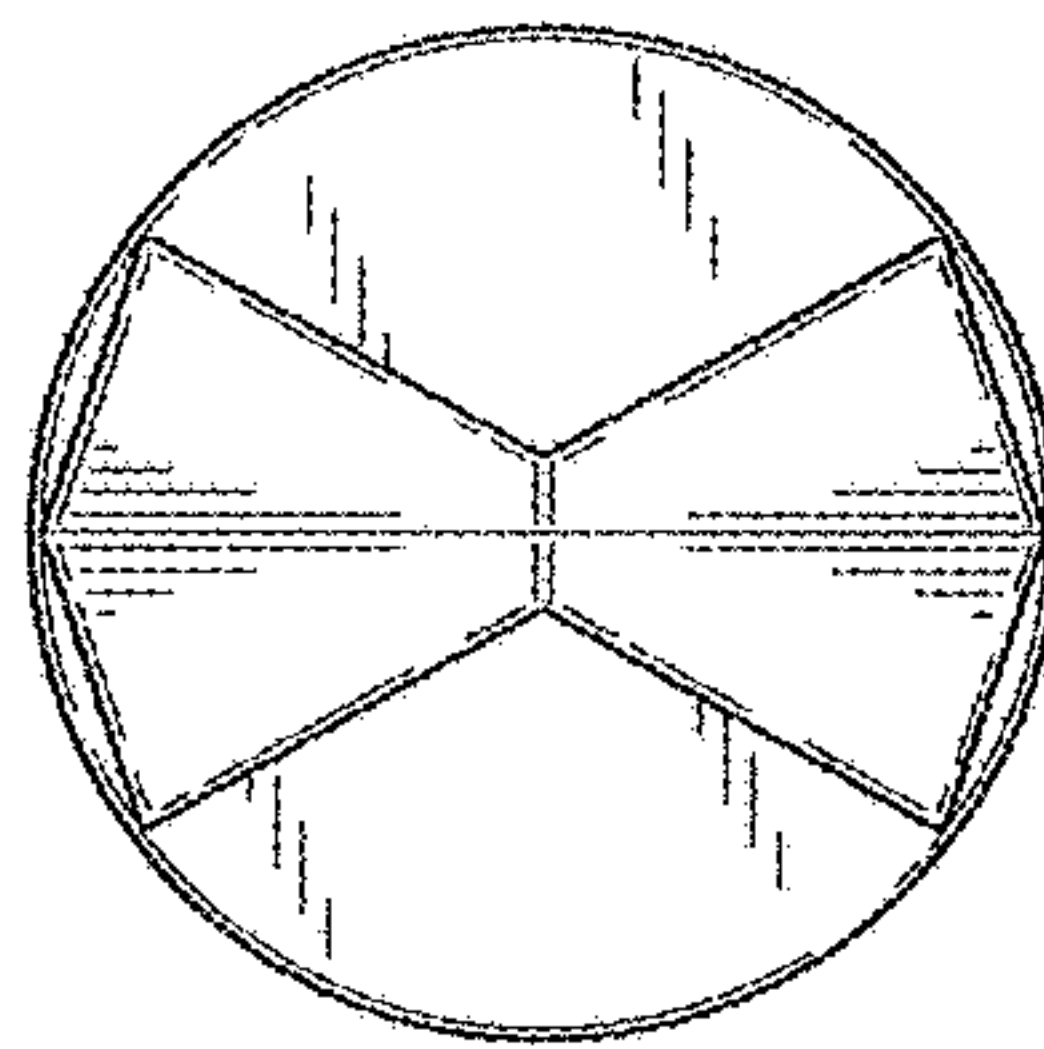

FIG. 8

