



US00D808712S

(12) **United States Design Patent**
Steininger et al.

(10) **Patent No.:** **US D808,712 S**
(45) **Date of Patent:** **** Jan. 30, 2018**

(54) **BEVERAGE VESSEL LID WITH COMPARTMENT**

(71) Applicants: **Jeff Steininger**, St. Mary's, OH (US);
Tai Shing Ng, Hong Kong (CN)

(72) Inventors: **Jeff Steininger**, St. Mary's, OH (US);
Tai Shing Ng, Hong Kong (CN)

(73) Assignee: **Zak Designs, Inc.**, Spokane, WA (US)

(**) Term: **15 Years**

(21) Appl. No.: **29/555,756**

(22) Filed: **Feb. 24, 2016**

(51) **LOC (11) Cl.** **07-99**

(52) **U.S. Cl.**
USPC **D7/396.2**

(58) **Field of Classification Search**
USPC ... D7/369.2, 392.1, 509-511, 513, 533, 536,
D7/586, 301-303, 619.1; D9/523-525,
(Continued)

(56) **References Cited**

U.S. PATENT DOCUMENTS

D512,875 S * 12/2005 Maldonado D7/510
7,124,907 B2 * 10/2006 Conaway A47G 19/2266
220/254.1

(Continued)

FOREIGN PATENT DOCUMENTS

KR 441312 Y1 * 8/2008
PH 2201500329 U1 * 7/2015

OTHER PUBLICATIONS

Zak Designs: Finding Dory zak!snak—Snack Cup, posted at
Youtube.com, posted on Sep. 29, 2016, site visited Feb. 9, 2017,
<<https://www.youtube.com/watch?v=XxwOxTrA-F0>>.*

(Continued)

Primary Examiner — Barbara Fox

Assistant Examiner — Messina L Smith

(74) *Attorney, Agent, or Firm* — Randall Danskin, P.S.

(57) **CLAIM**

The ornamental design for a beverage vessel lid with compartment, as shown and described.

DESCRIPTION

FIG. 1 is a perspective view of a beverage vessel lid with compartment showing my new design, shown in a closed configuration;

FIG. 2 is a first side elevation view thereof;

FIG. 3 is a second side elevation view thereof, approximately 90° offset from that seen in FIG. 2;

FIG. 4 is a third side elevation view thereof, from that as seen in FIG. 3;

FIG. 5 is a fourth side elevation view thereof, opposite from that as seen in FIG. 2;

FIG. 6 is a top plan view thereof;

FIG. 7 is a bottom plan view thereof;

FIG. 8 is a perspective view of the beverage vessel lid with compartment shown in an open configuration;

FIG. 9 is a first side elevation view thereof;

FIG. 10 is a second side elevation view thereof, approximately 90° offset from that seen in FIG. 9;

FIG. 11 is a third side elevation view thereof, opposite from that seen in FIG. 10;

FIG. 12 is a fourth side elevation view thereof, opposite from that seen in FIG. 9;

FIG. 13 is a top plan view thereof;

FIG. 14 is a bottom plan view thereof; and,

FIG. 15 is an exploded perspective view of the beverage vessel lid with compartment, shown in a closed configuration, in an environment of use.

The broken line showing of the beverage vessel in FIG. 15 illustrates environment and forms no part of the claimed design. All other broken lines illustrate portions of the beverage vessel lid with compartment that form no part of the claimed design.

1 Claim, 15 Drawing Sheets

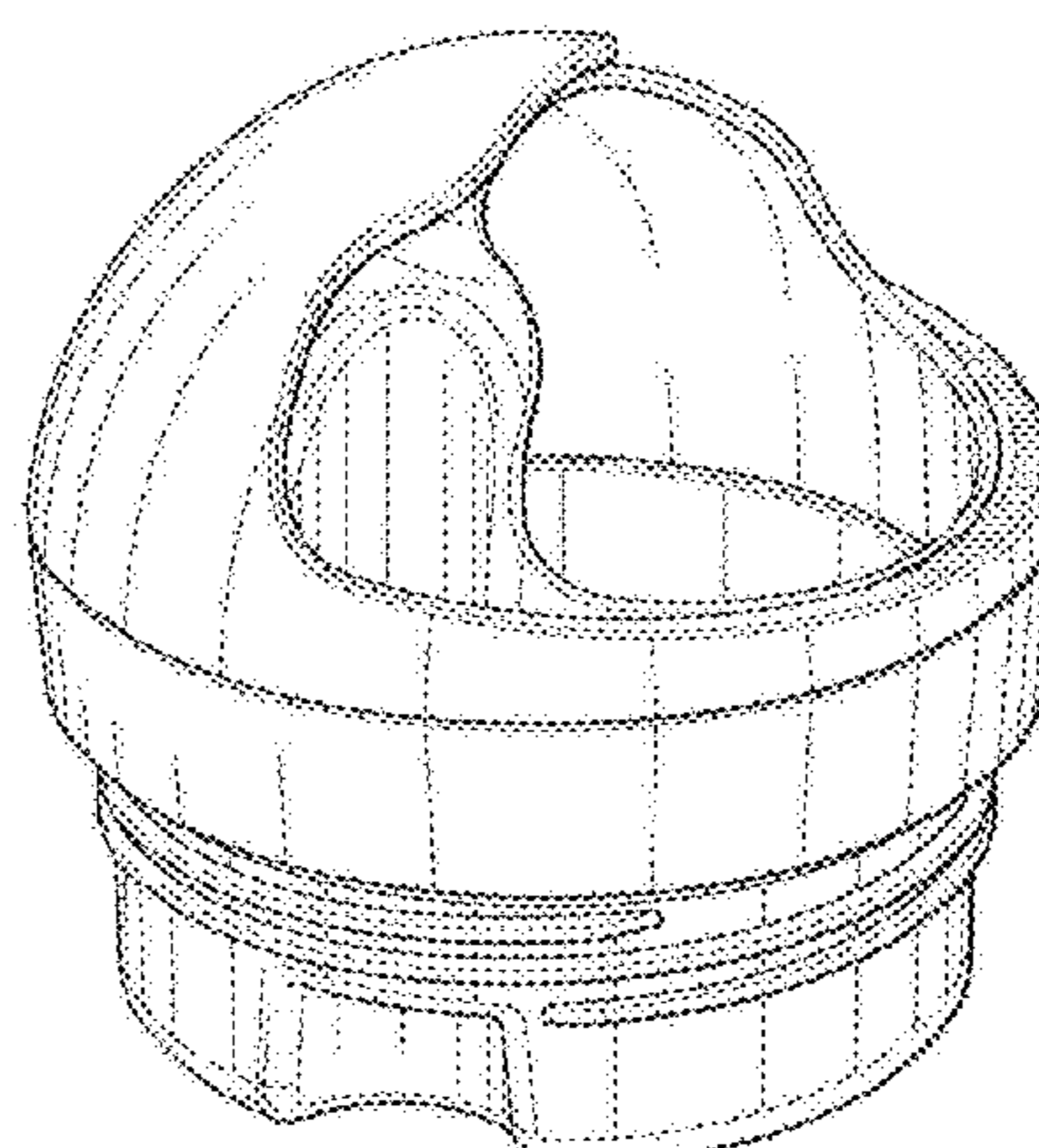
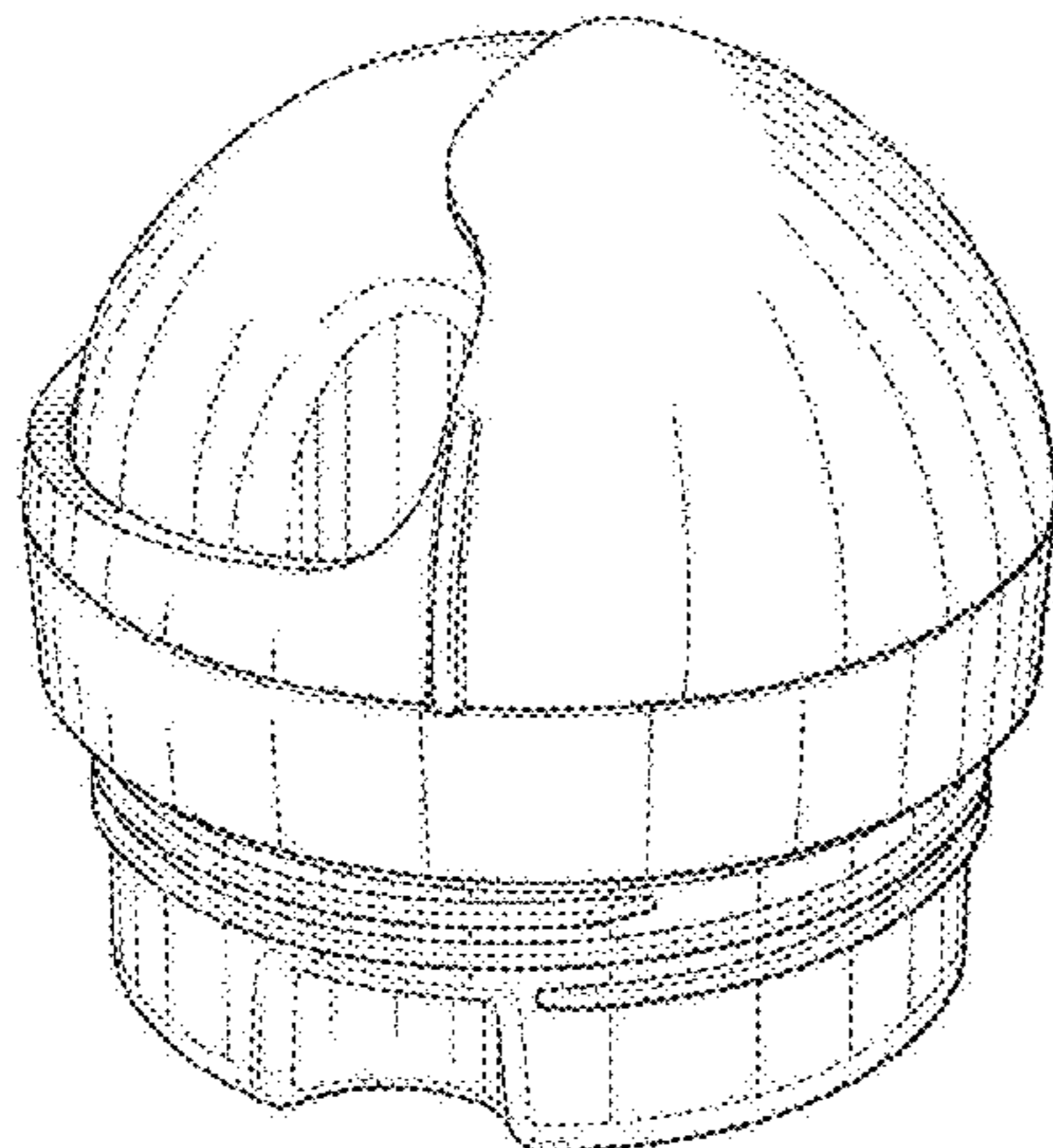

(58) **Field of Classification Search**

USPC D9/528–529, 531, 536, 544, 435–436,
 D9/439–440, 443, 447
 CPC A47G 19/22; A47G 19/2205; A47G
 19/2272; A47G 19/2283; A47G 19/2294;
 B65D 2543/00046; B65D 2543/00027;
 B65D 2543/00055; B65D 2543/00009;
 B65D 2539/00; B65D 39/00; B65D
 41/00; B65D 41/02; B65D 41/023; B65D
 41/04; B65D 43/00; B65D 43/02; B65D
 43/0225; B65D 43/0233; B65D 43/06;
 B65D 43/12; B65D 47/06; B65D 47/061;
 B65D 47/065; B65D 47/08

See application file for complete search history.

(56) **References Cited**

U.S. PATENT DOCUMENTS

D672,650 S * 12/2012 Wisniewski D9/443
 D674,100 S * 1/2013 Smith D24/197
 D683,188 S * 5/2013 Gold D7/510
 D725,434 S * 3/2015 De Leo D7/392.1
 D730,697 S * 6/2015 Johnson D7/510

D747,921 S * 1/2016 Hakim D7/396.2
 2009/0250478 A1 * 10/2009 Roth A47G 19/2266
 220/703
 2009/0255944 A1 * 10/2009 Yamashita A47G 19/2266
 220/705
 2014/0027365 A1 * 1/2014 Lee A45F 3/16
 210/232
 2016/0137361 A1 * 5/2016 Snow B65D 47/261
 220/253

OTHER PUBLICATIONS

Zak Releasing zak!snak Container for Toddlers, posted at Gmdc.com, posted on Dec. 22, 2016, site visited Feb. 9, 2017, <<https://www.gmdc.org/news/2016/12/zak-releasing-zaksnak-container-for-toddlers>>.*

zak!snak Drink and Snack Cups, posted at Zak.com, no posting date given, © 2017, site visited Feb. 9, 2017, <<https://www.zak.com/zaksnak-snack-and-drink-cup-container>>.*

Zak! Designs Zak! Snak Snack & Drink Container, posted at Amazon.com, posted on May 6, 2016, site visited Feb. 9, 2017, <<https://www.amazon.com/Zak-Designs-Container-Featuring-Break-resistant/dp/B01F808G2G>>.*

* cited by examiner

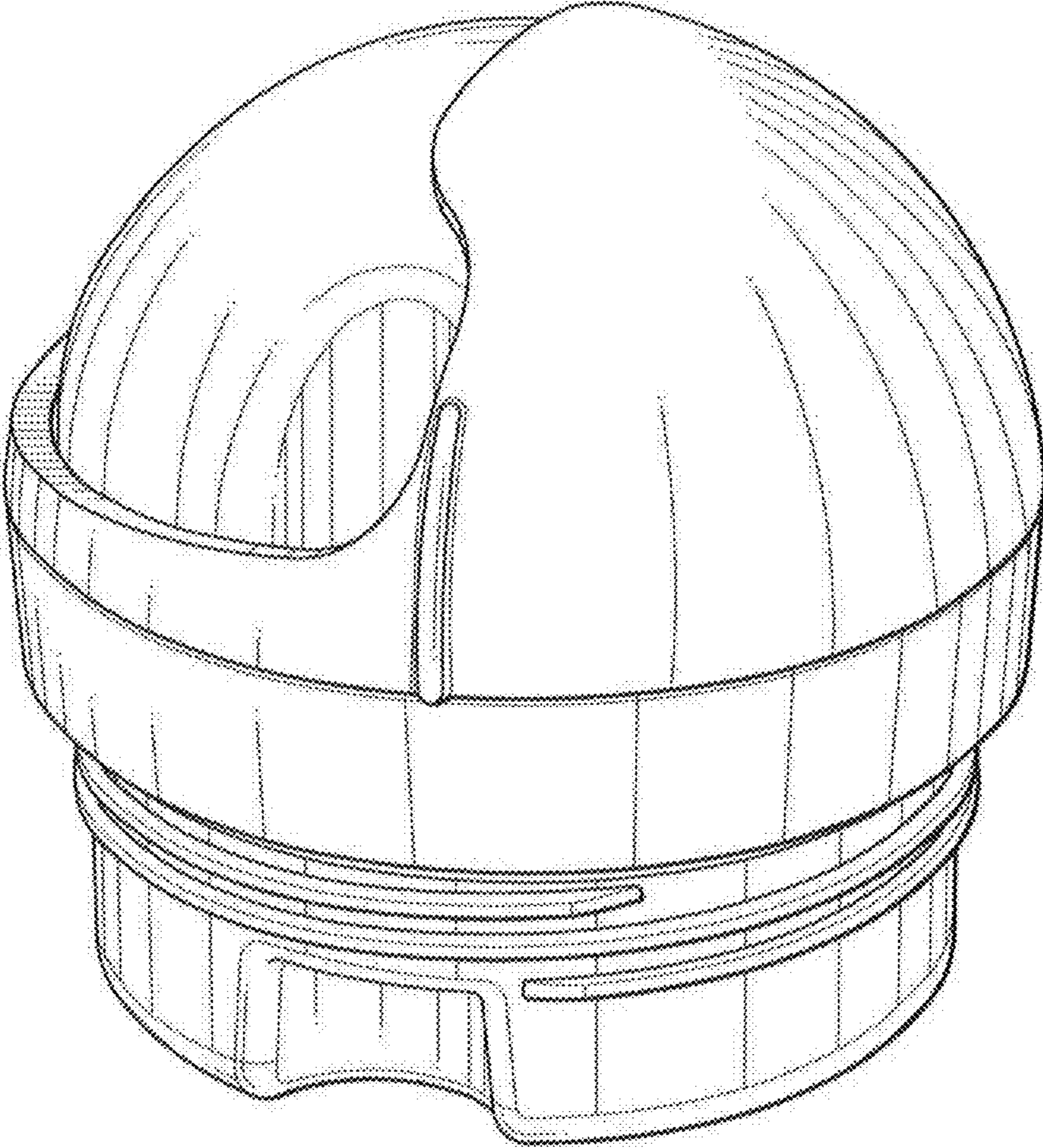

FIG. 1

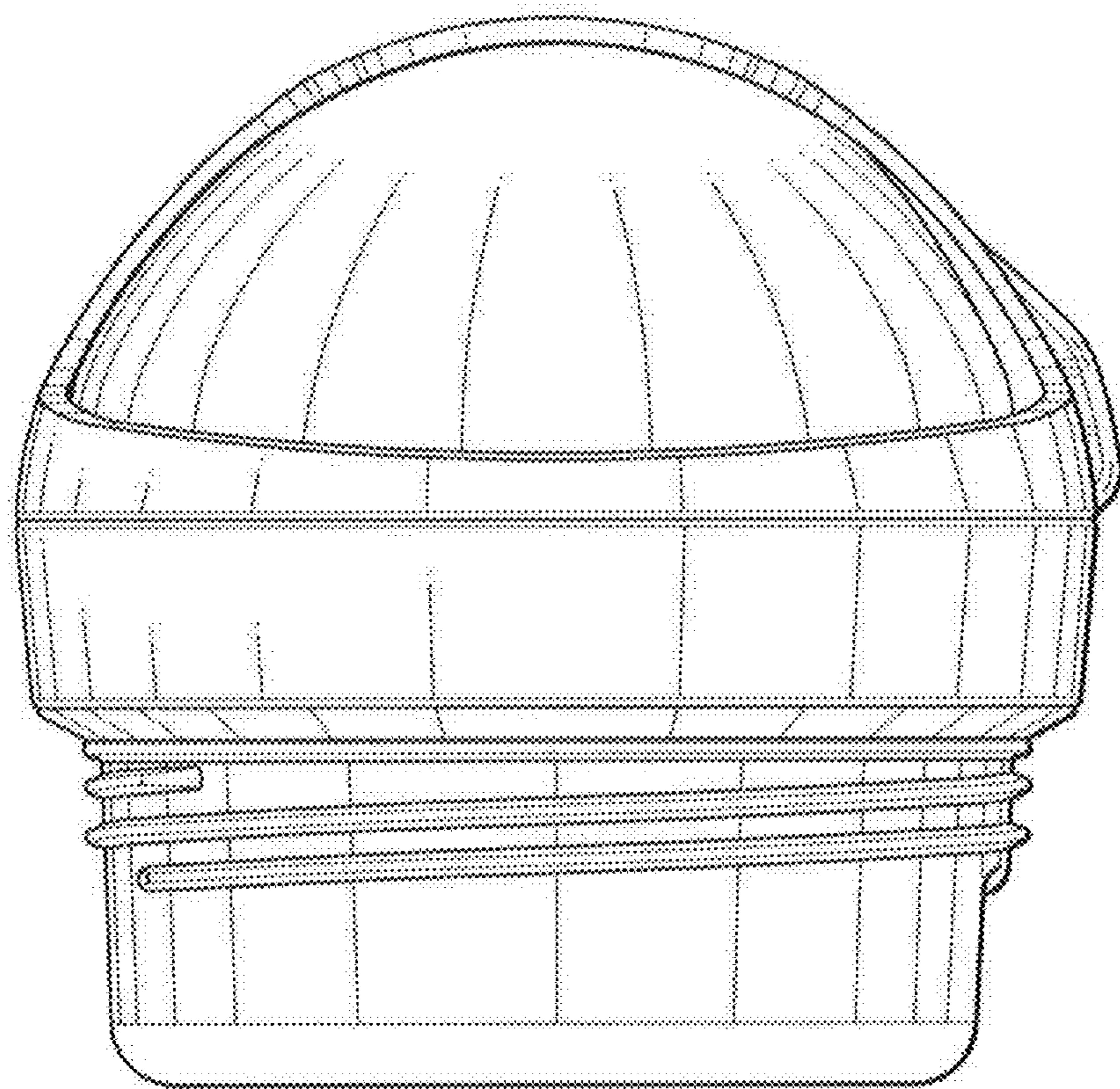

FIG. 2

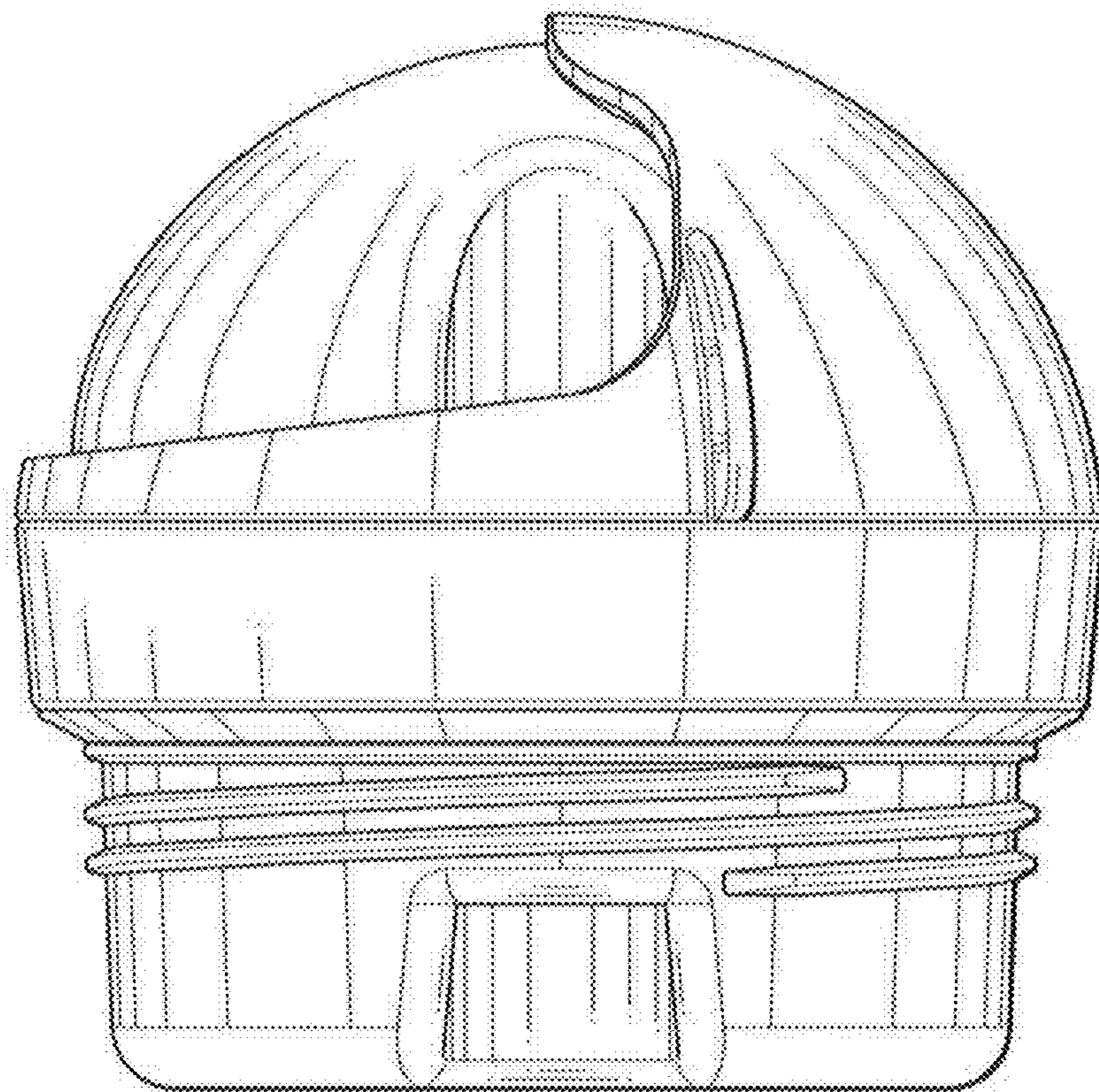

FIG. 3

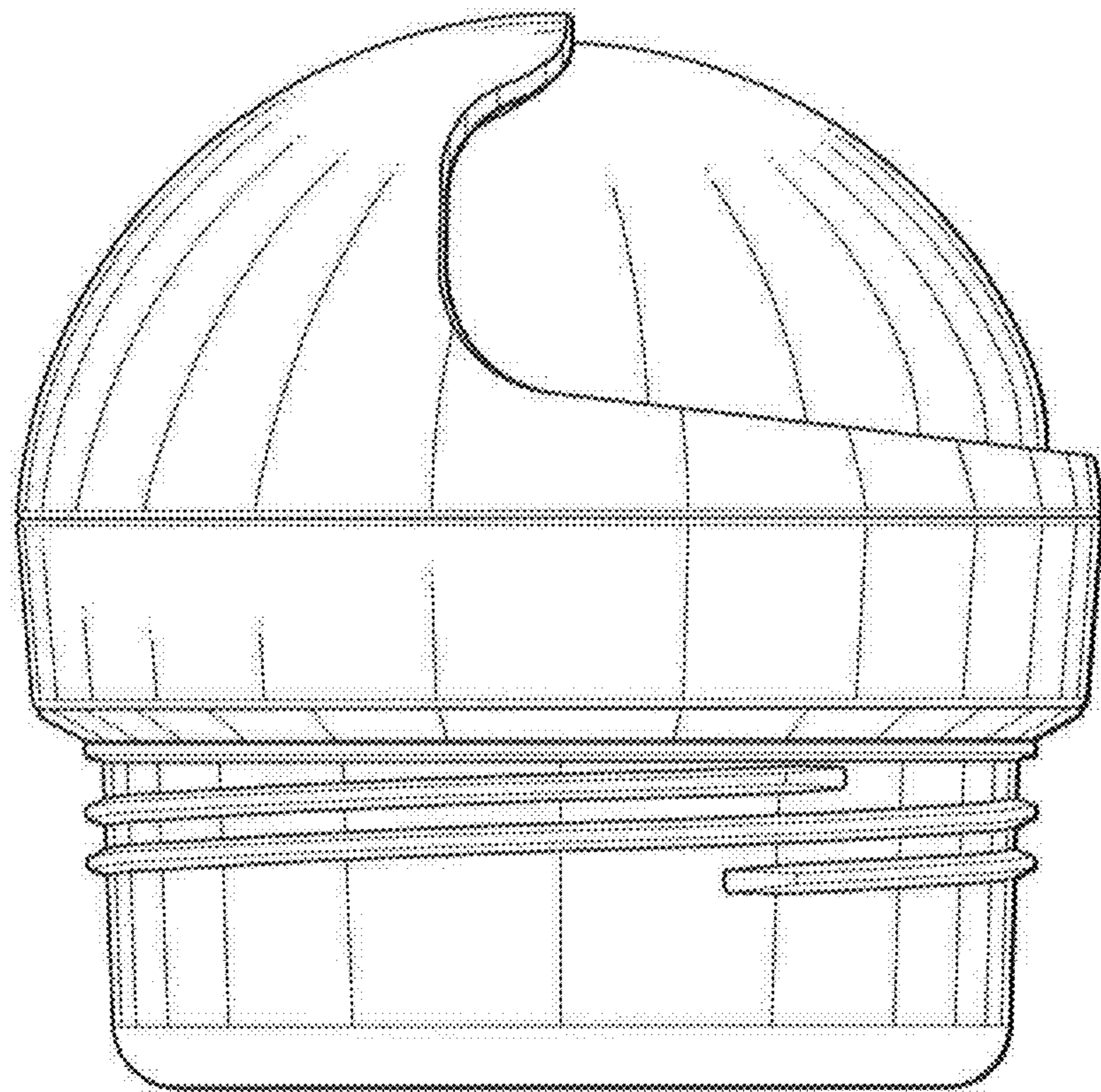

FIG. 4

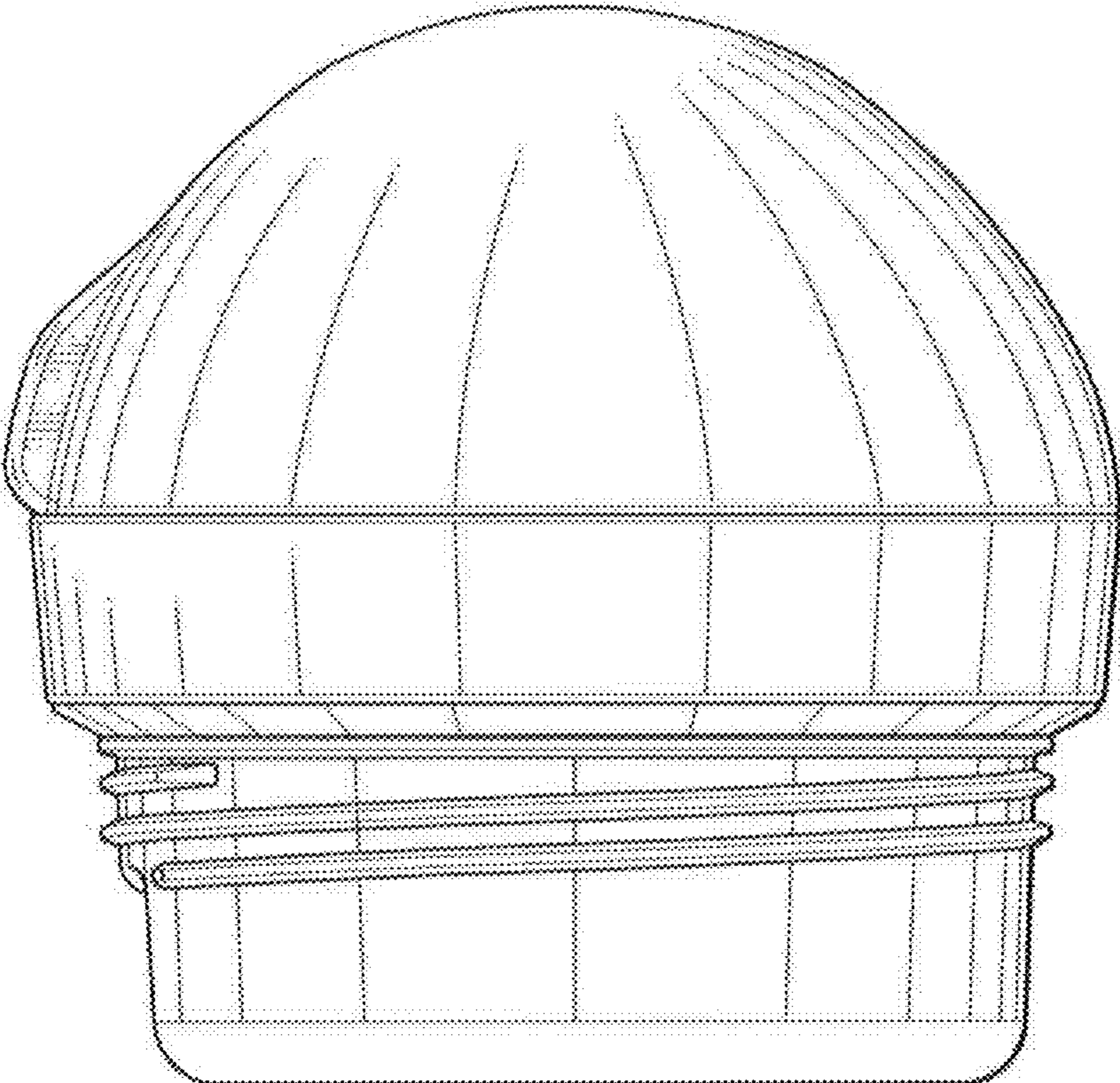

FIG. 5

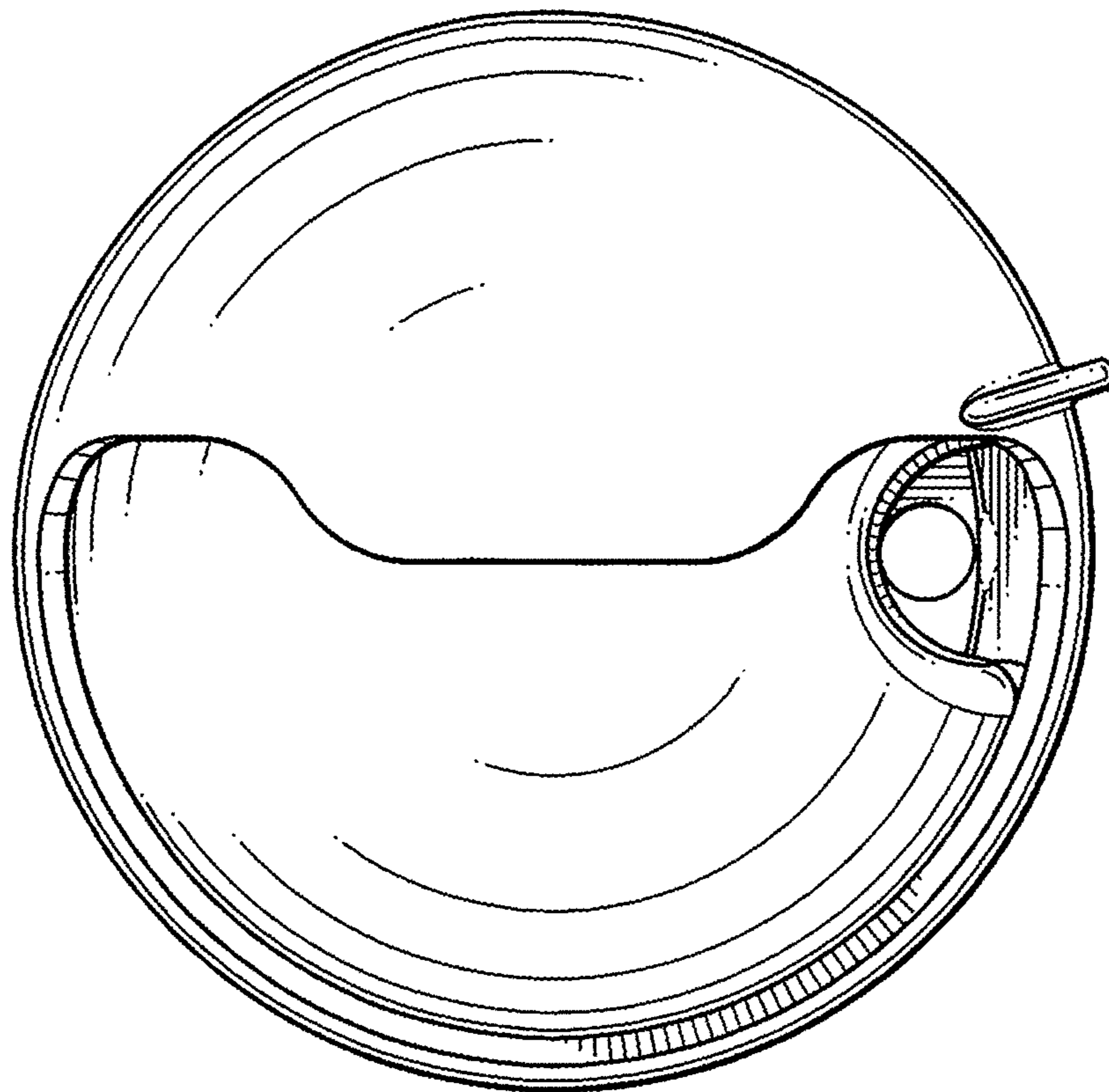

FIG. 6

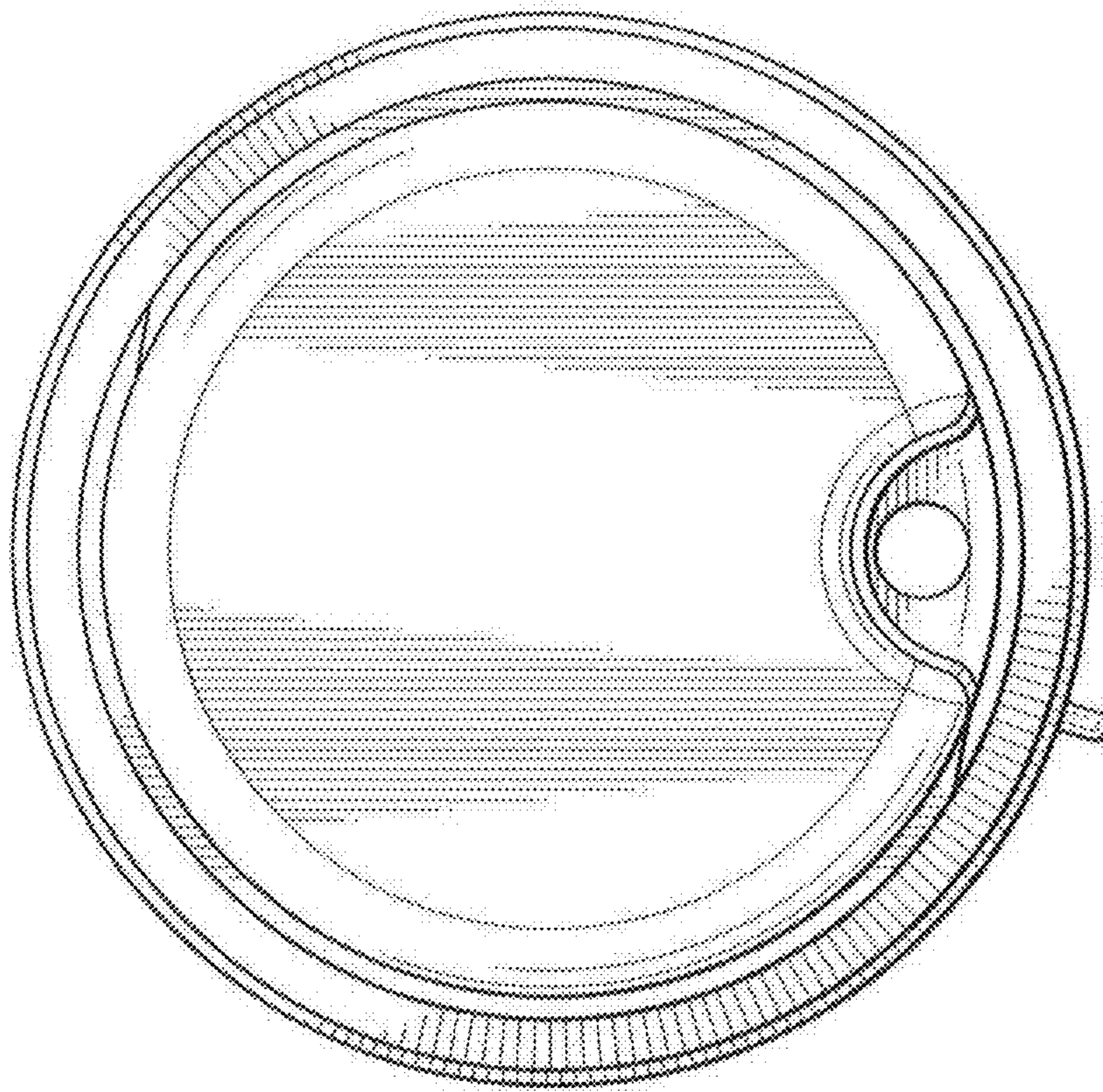

FIG. 7

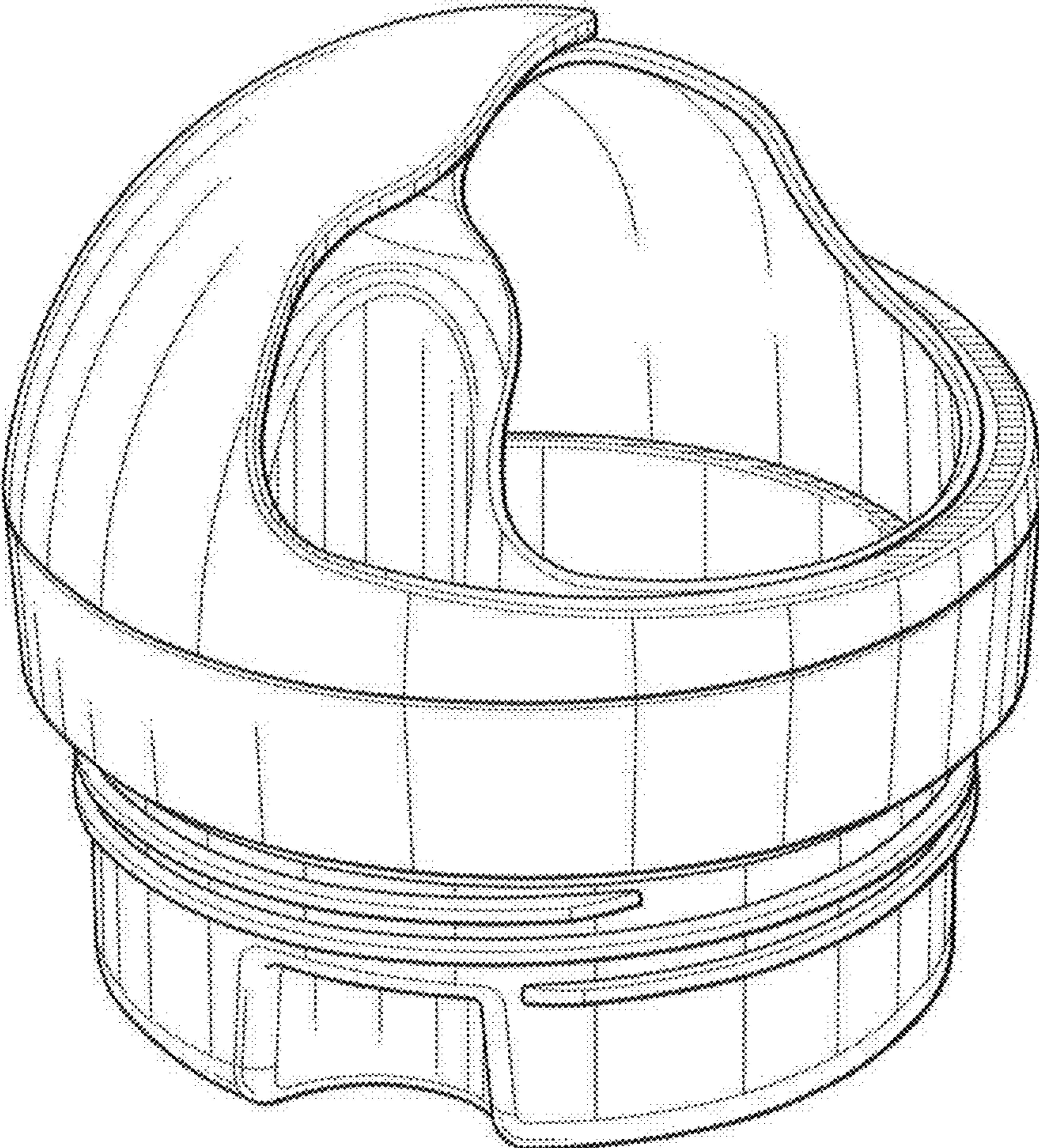

FIG. 8

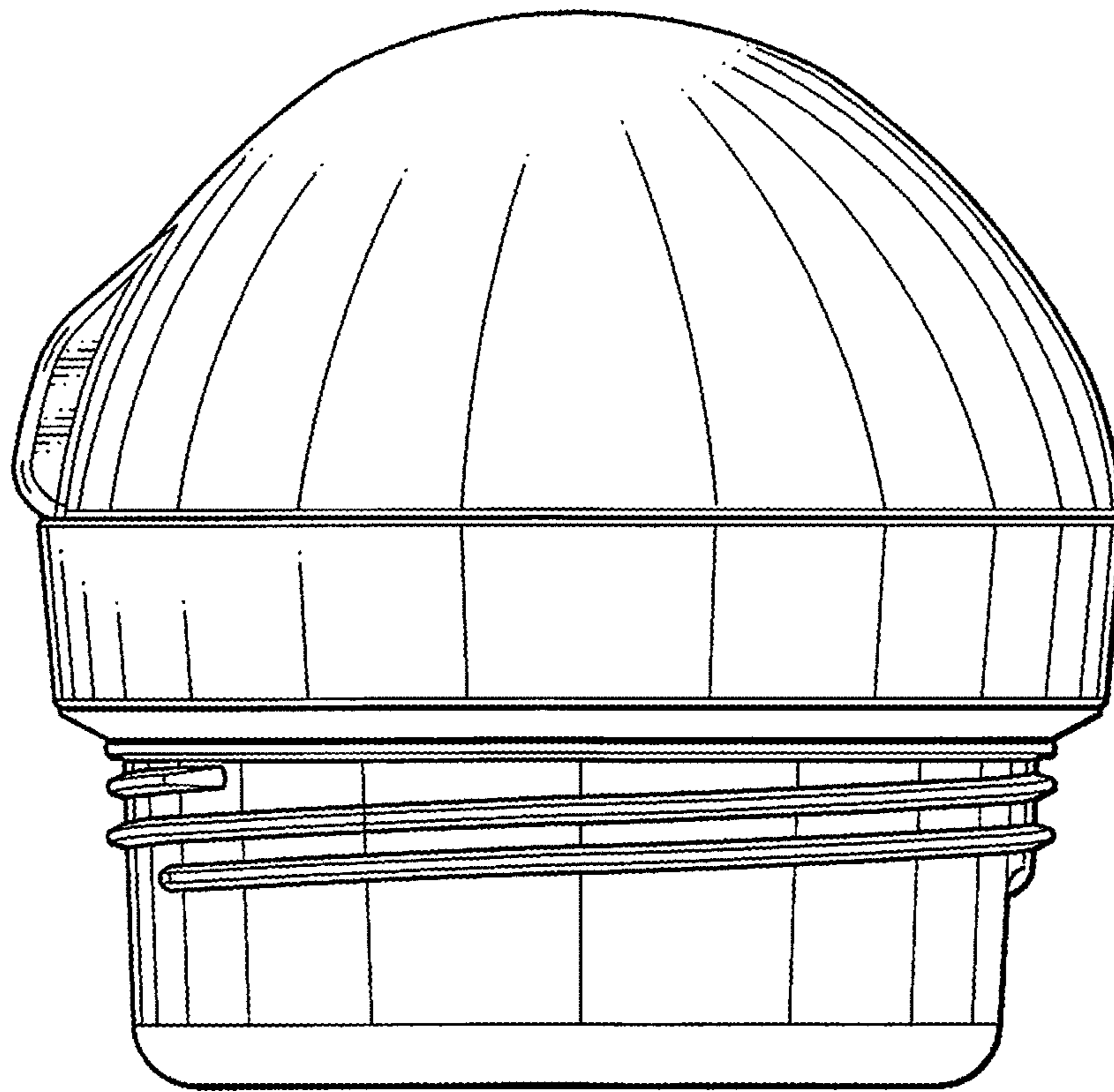

FIG. 9

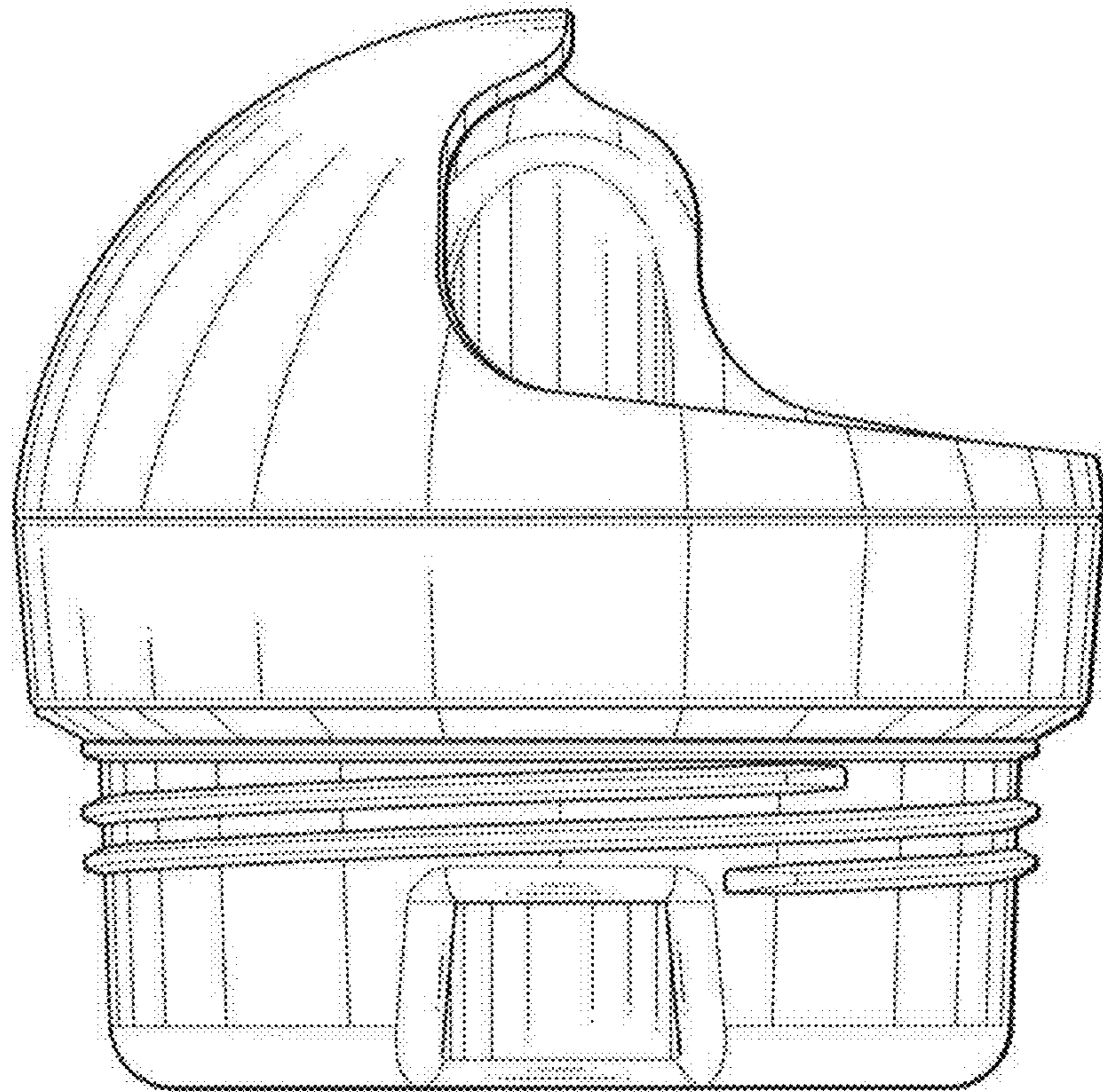

FIG. 10

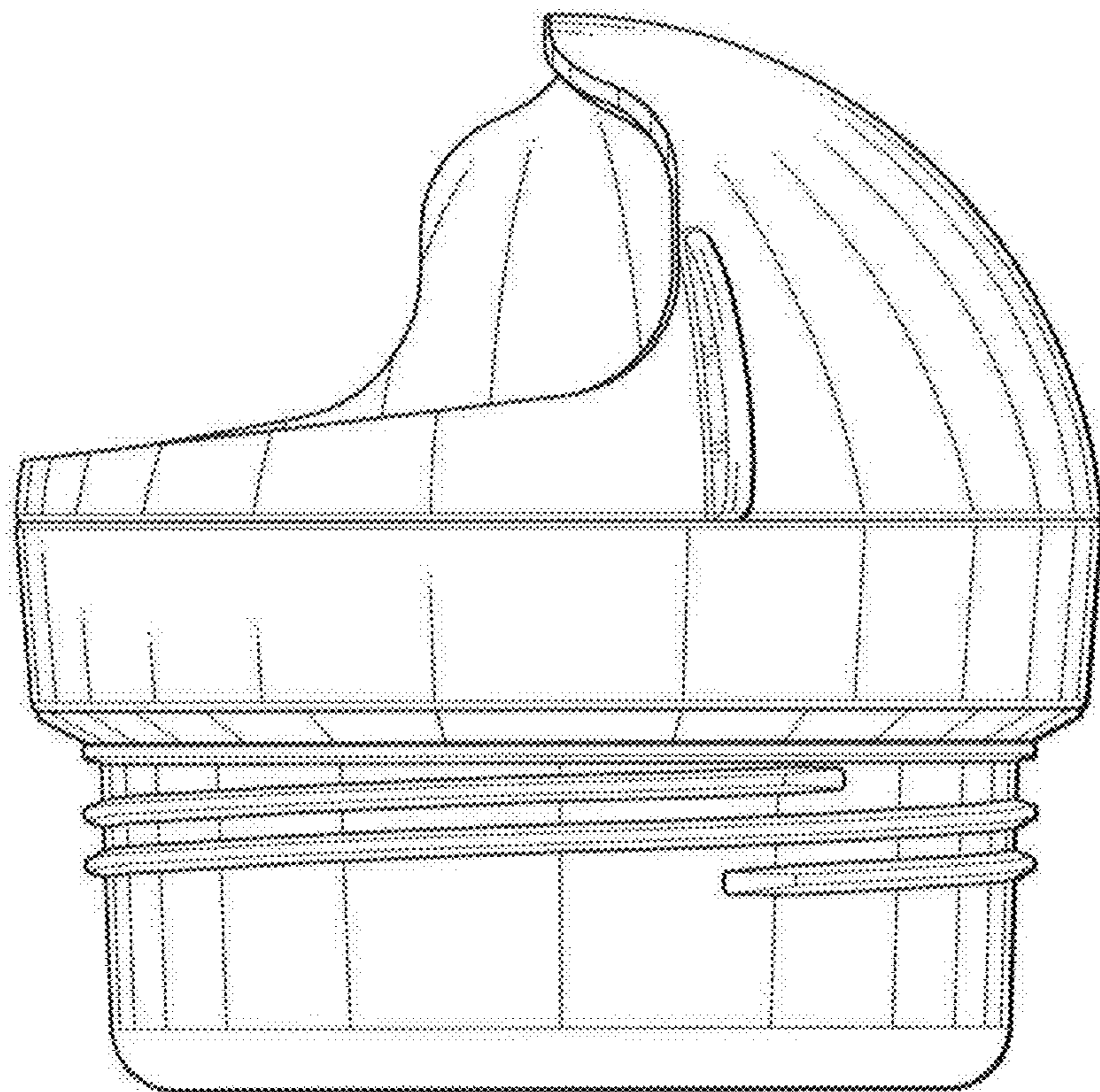

FIG. 11

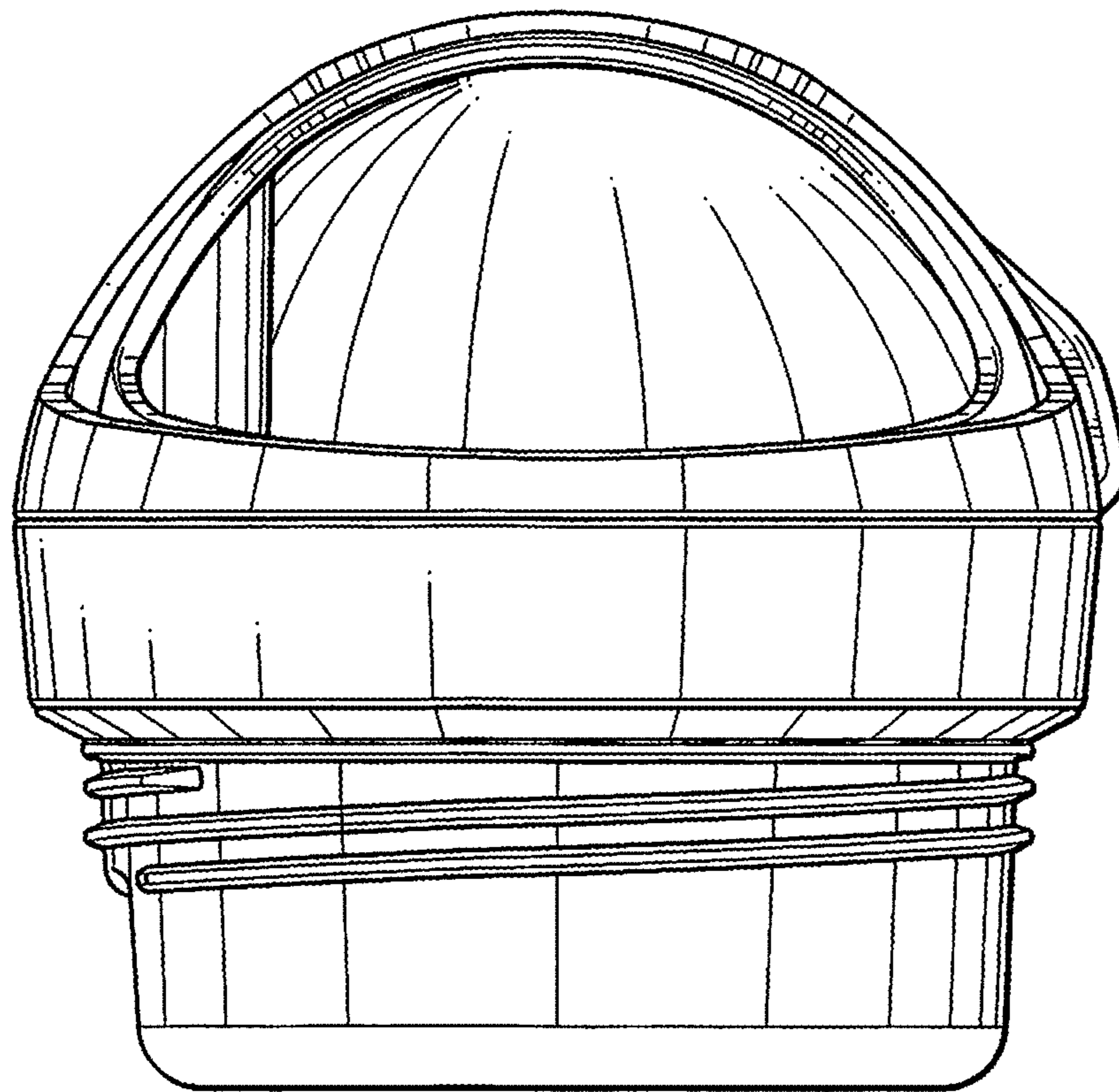

FIG. 12

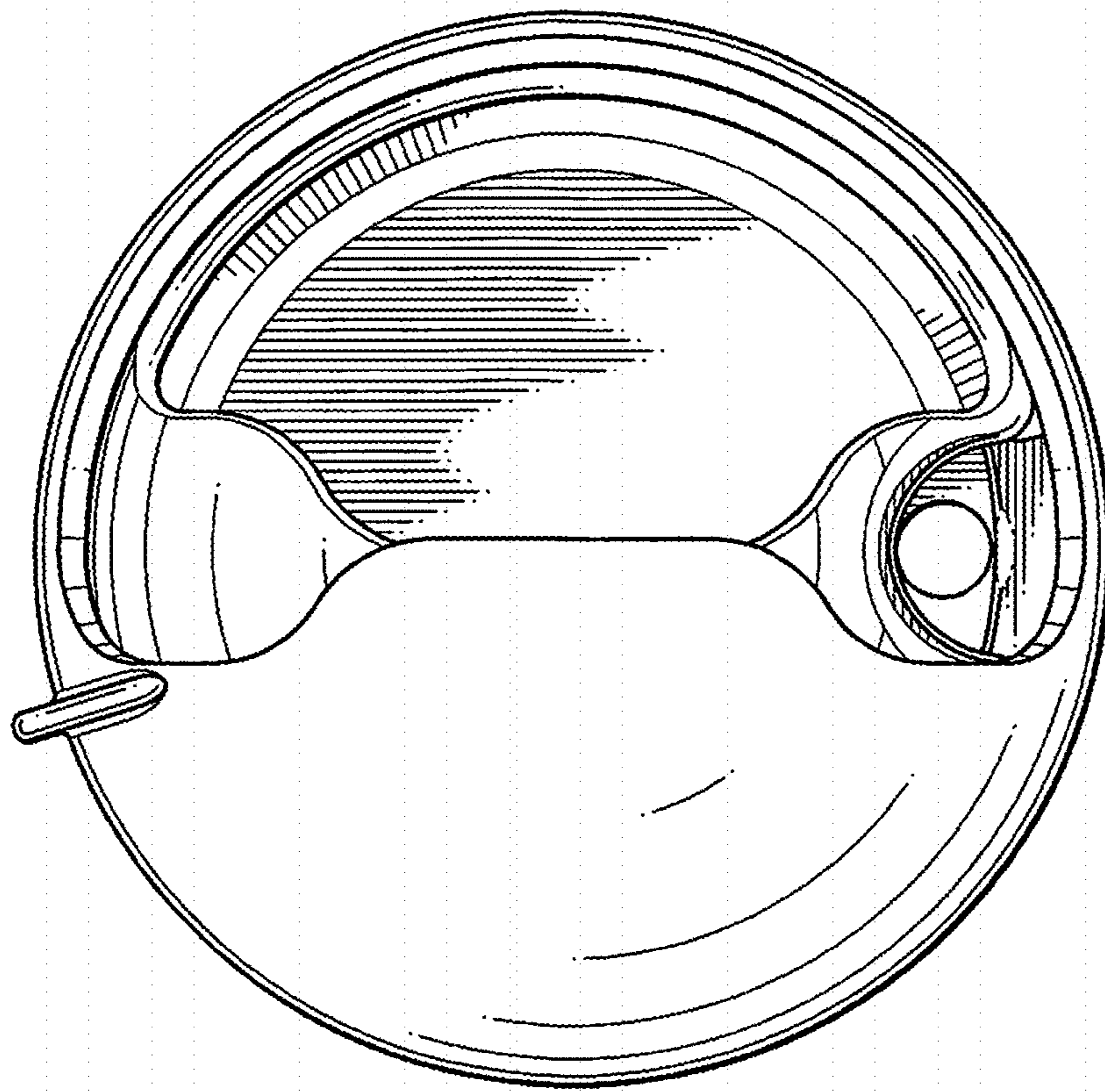

FIG. 13

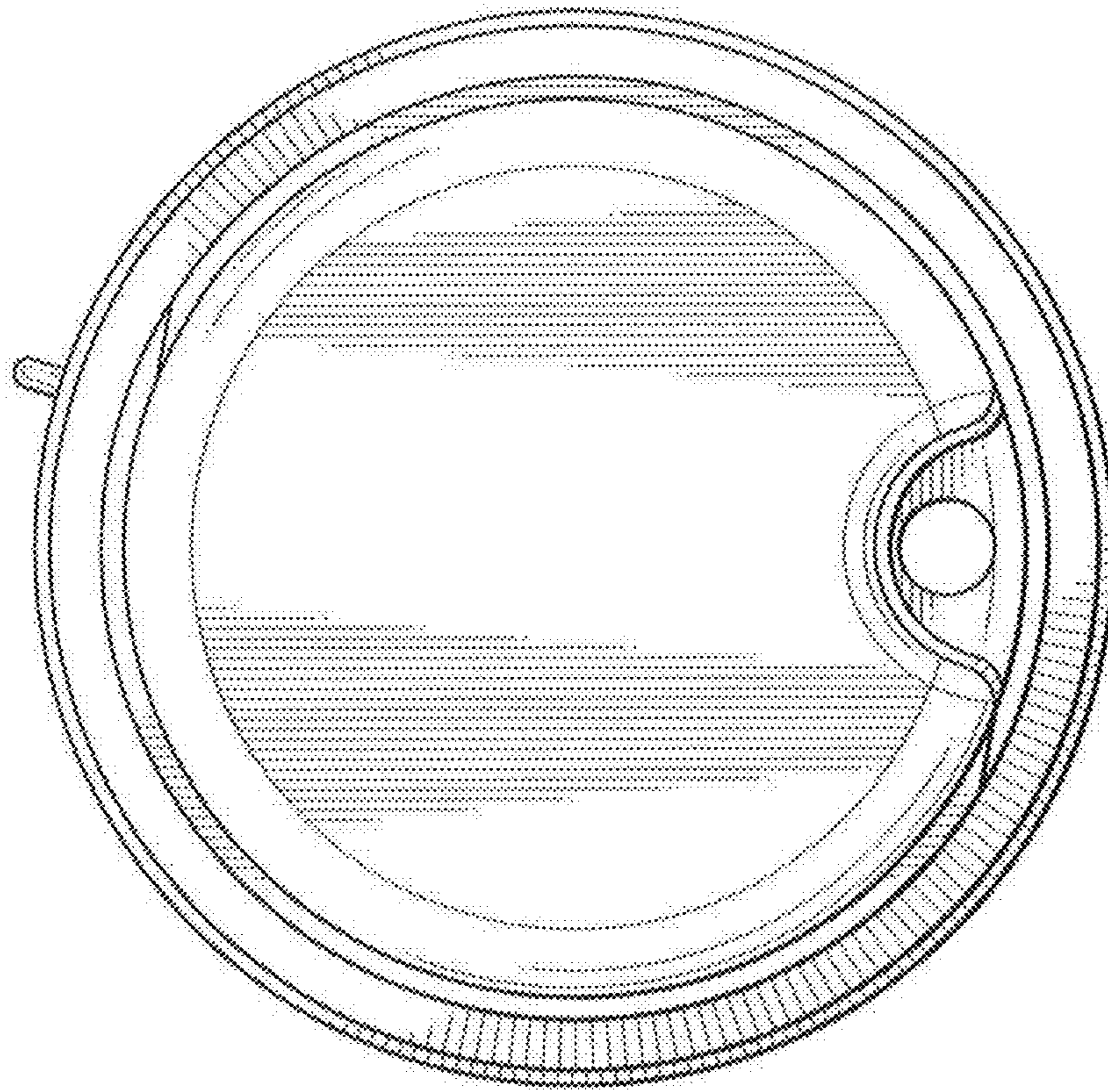

FIG. 14

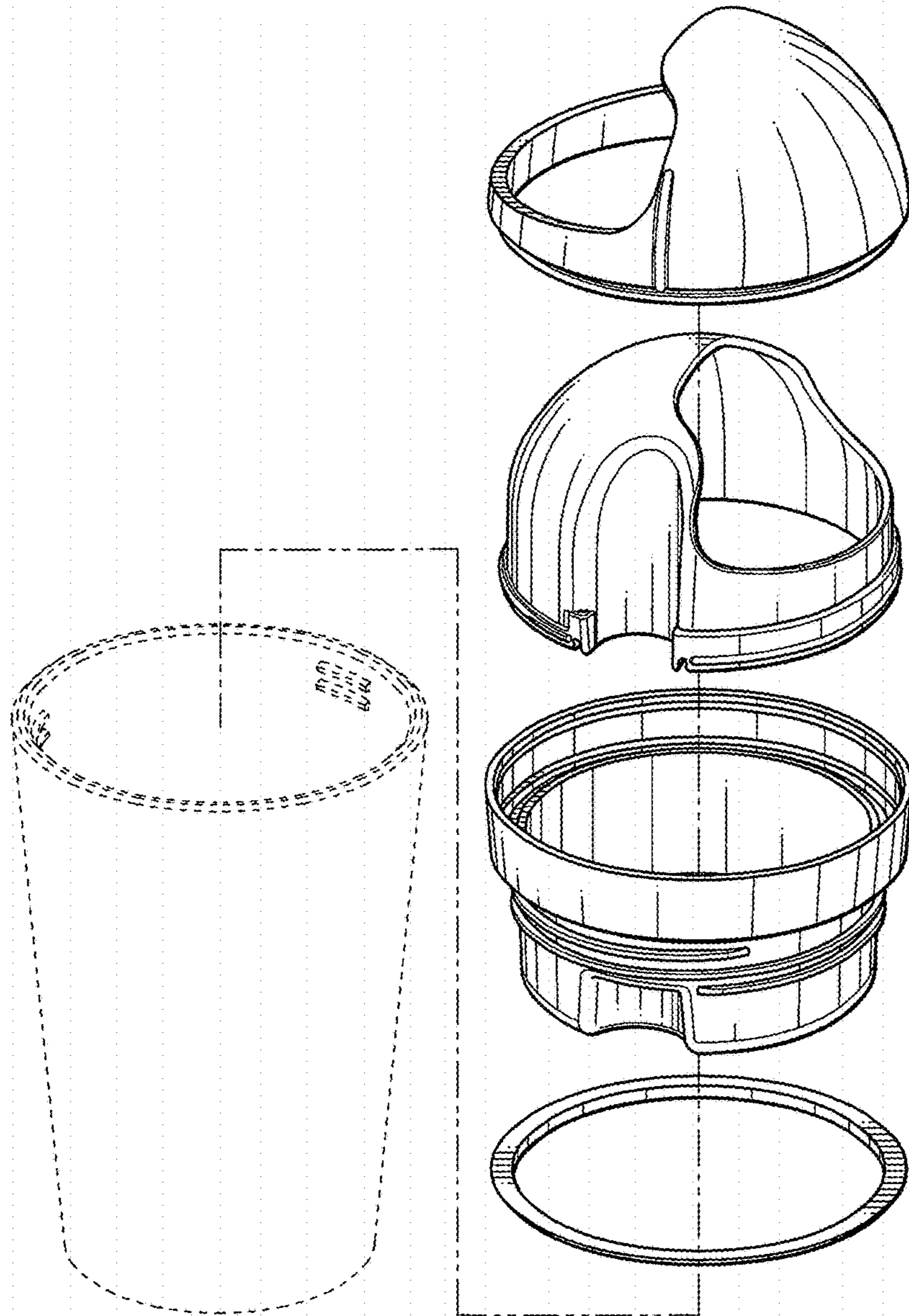

FIG. 15