



US00D808648S

(12) **United States Design Patent**
Gumina

(10) **Patent No.:** **US D808,648 S**

(45) **Date of Patent:** **** Jan. 30, 2018**

(54) **HANDBAG**

(71) Applicant: **Danielle Gumina**, North Brunswick, NJ
(US)

(72) Inventor: **Danielle Gumina**, North Brunswick, NJ
(US)

(**) Term: **15 Years**

(21) Appl. No.: **29/537,684**

(22) Filed: **Aug. 27, 2015**

(51) **LOC (11) Cl.** **03-01**

(52) **U.S. Cl.**
USPC **D3/246**

(58) **Field of Classification Search**
USPC D3/215-217, 226, 227, 232-234,
D3/238-246, 247, 250, 254, 257, 270,
D3/271.1, 271.9, 272, 274-276, 283, 285,
D3/287, 289, 291, 294, 299, 303, 324,
D3/326, 900, 902, 903
CPC A45C 1/00; A45C 3/06; A45C 2007/004;
A45C 3/08; A45C 7/00; A45C 9/10
See application file for complete search history.

(56) **References Cited**

U.S. PATENT DOCUMENTS

D126,220 S *	4/1941	Goldsmith	150/106
D130,753 S *	12/1941	de Kiszely	D3/243
D135,605 S *	5/1943	Kalisher	150/129
D142,442 S *	9/1945	Rath	D3/246
D147,152 S *	7/1947	Spielberg	D3/245
D262,587 S *	1/1982	Hyers	D3/246
D270,496 S *	9/1983	Hyers	D3/246
D435,964 S *	1/2001	Lentz	D3/201
D485,983 S *	2/2004	Gilad	D3/232

D509,059 S *	9/2005	Hayes	D3/246
D521,233 S *	5/2006	Gonzalez	D3/232
D531,795 S *	11/2006	Gonzalez	D3/239
D533,415 S *	12/2006	Lown	D7/709
D584,048 S *	1/2009	Lown	D3/245
D592,912 S *	5/2009	Lown	D3/232
D619,861 S *	7/2010	Swartz	D3/232
D682,053 S *	5/2013	Boroski	D7/709
D685,179 S *	7/2013	Hubbell	D3/232
D685,572 S *	7/2013	Gellis	D3/232
D690,097 S *	9/2013	Phillips	D3/232
D690,506 S *	10/2013	Kuster	D3/232
D693,117 S *	11/2013	Maier	D3/232
D698,148 S *	1/2014	Sassi	D3/247
D707,042 S *	6/2014	Ruzzenente	D3/232
D712,138 S *	9/2014	Kao	D3/232

* cited by examiner

Primary Examiner — Susan E Krakower
Assistant Examiner — L. A. Grabenstetter
(74) *Attorney, Agent, or Firm* — LaMorte & Associates
P.C.

(57) **CLAIM**

The ornamental design for a handbag, as shown and described.

DESCRIPTION

FIG. 1 is a perspective view of a handbag, showing my new design;
FIG. 2 is a front view thereof, the rear view being a mirror image thereof;
FIG. 3 is a left side view thereof;
FIG. 4 is a right side view thereof;
FIG. 5 is a top plan view thereof; and,
FIG. 6 is a bottom plan view thereof.

1 Claim, 4 Drawing Sheets

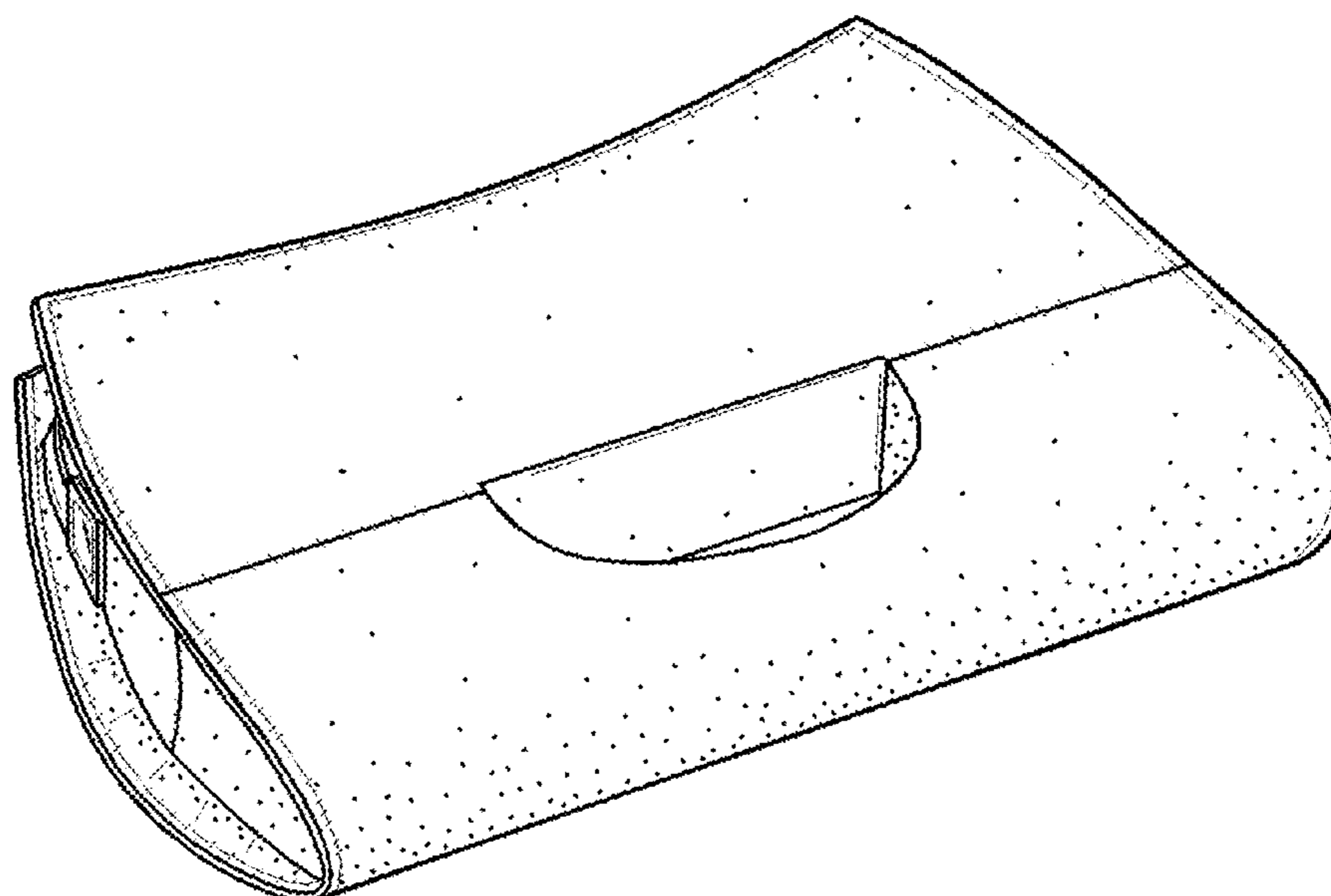

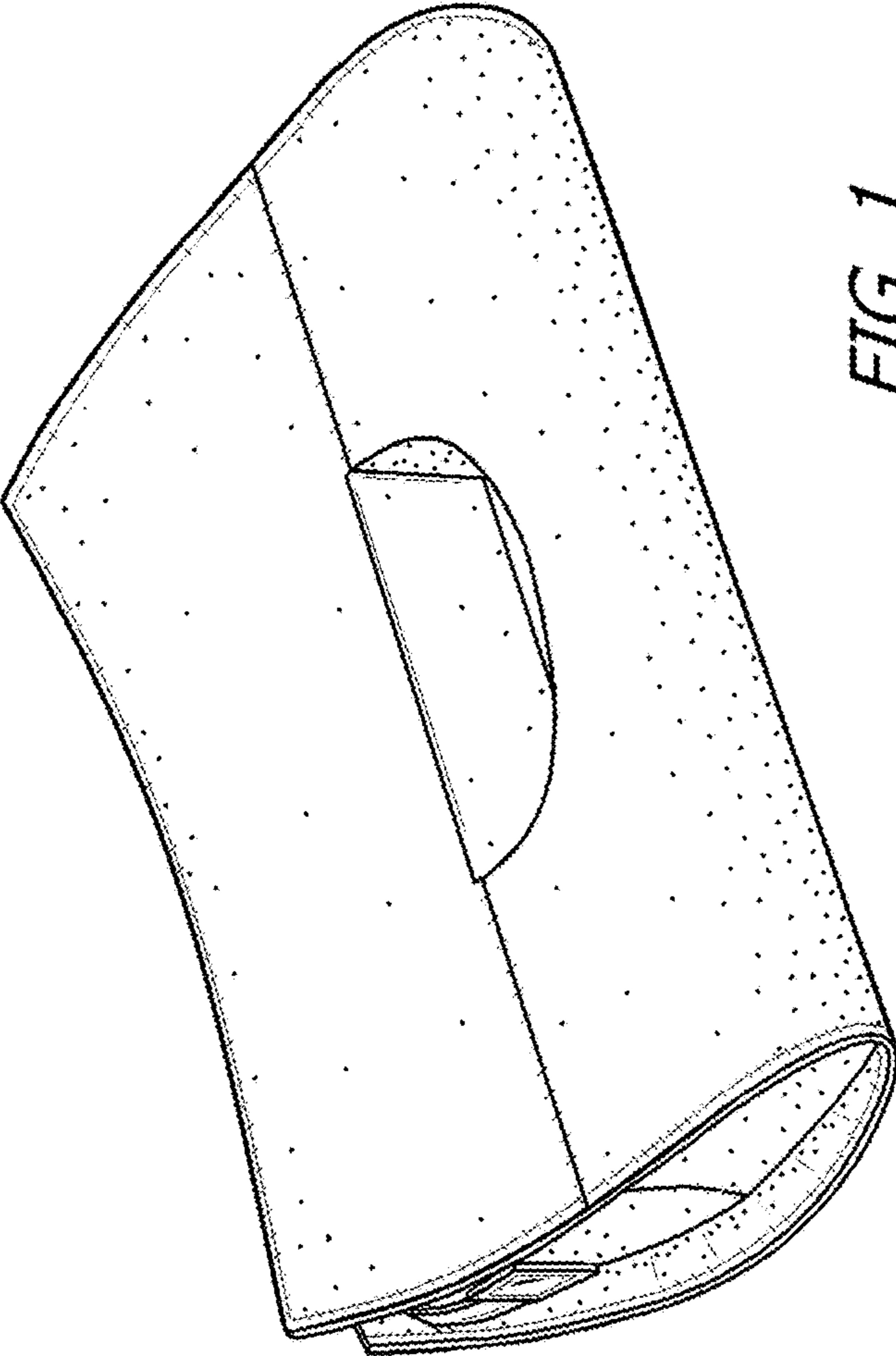

FIG. 1

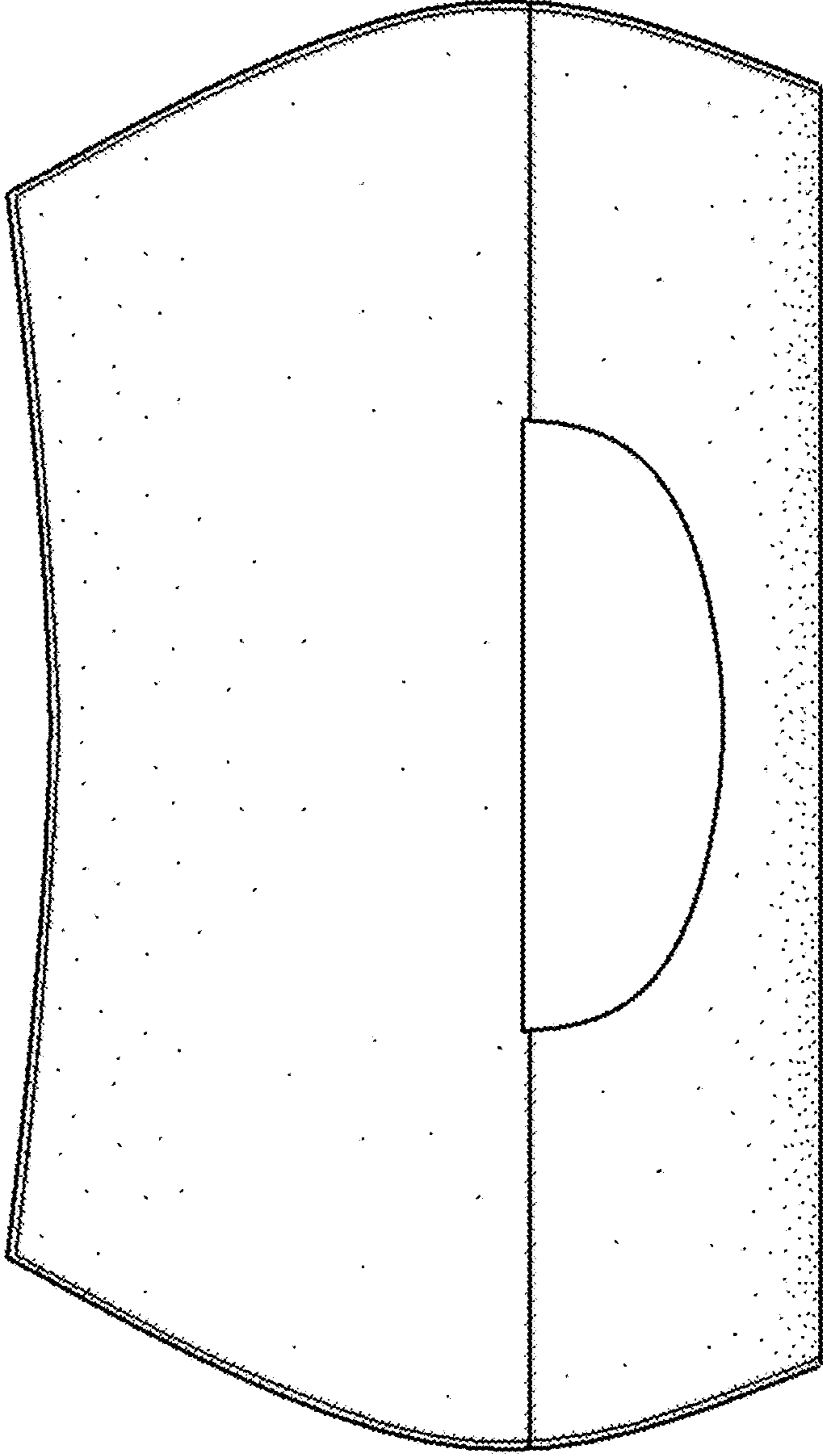

FIG. 2

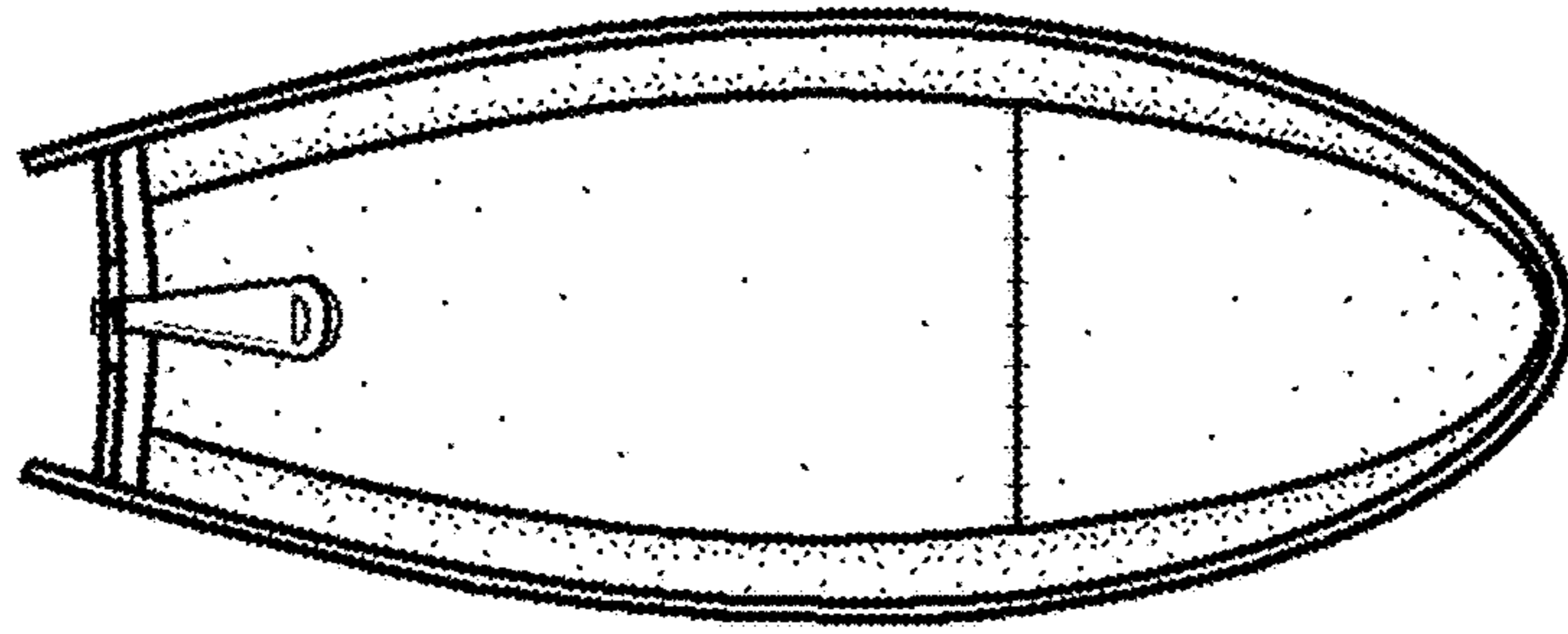

FIG. 4

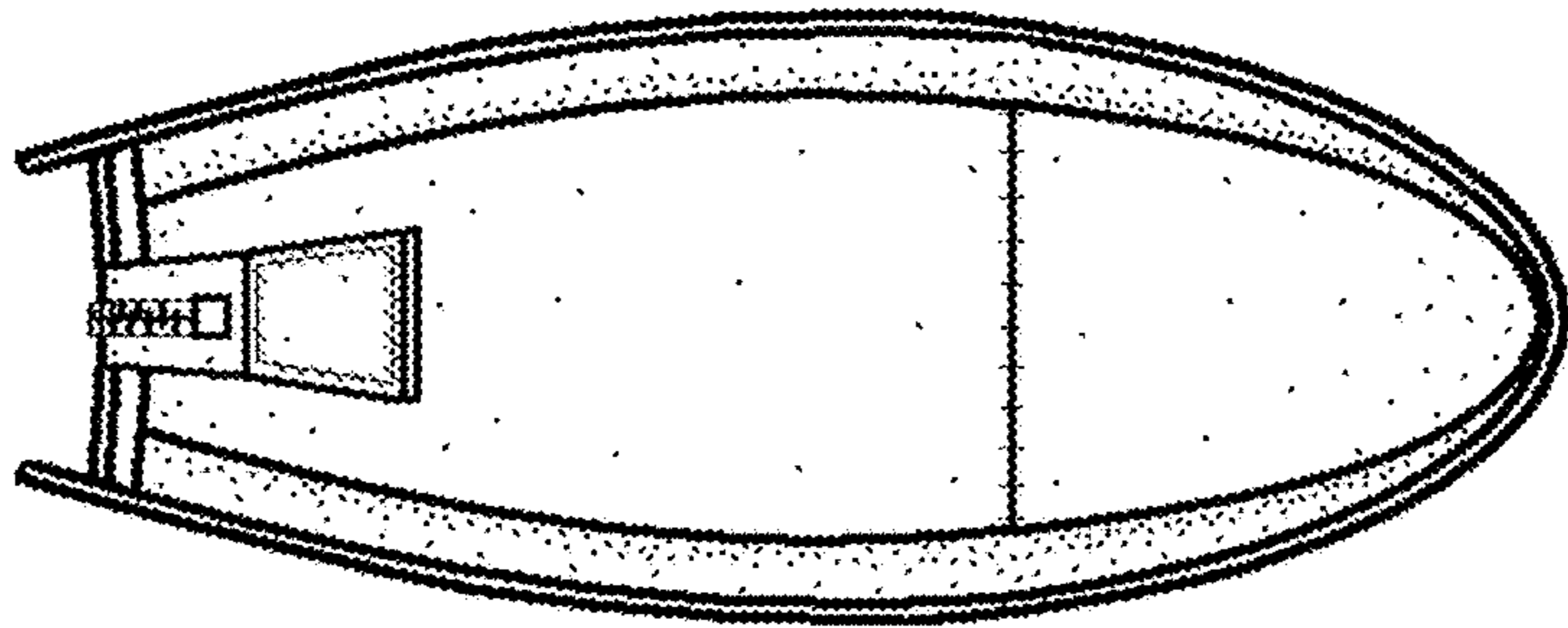

FIG. 3

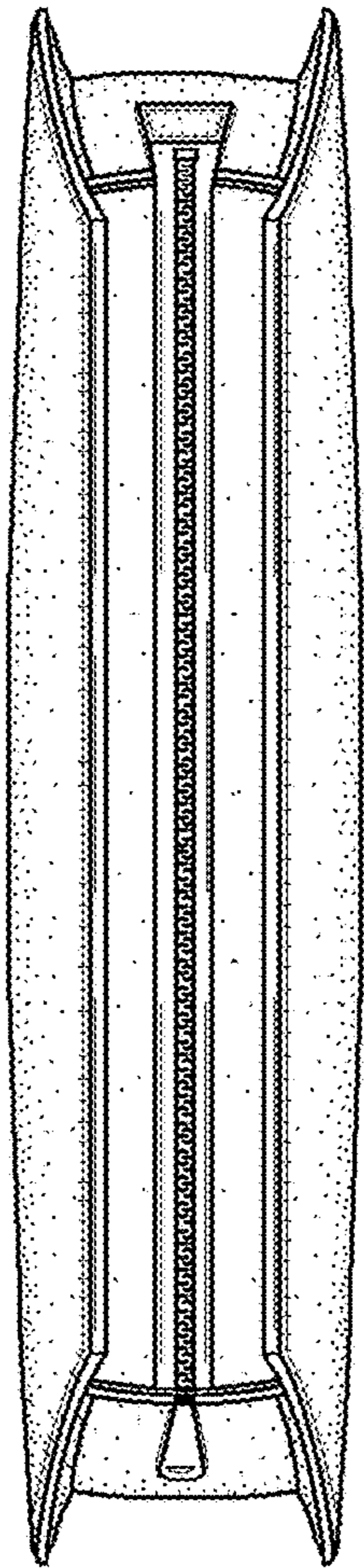

FIG. 5

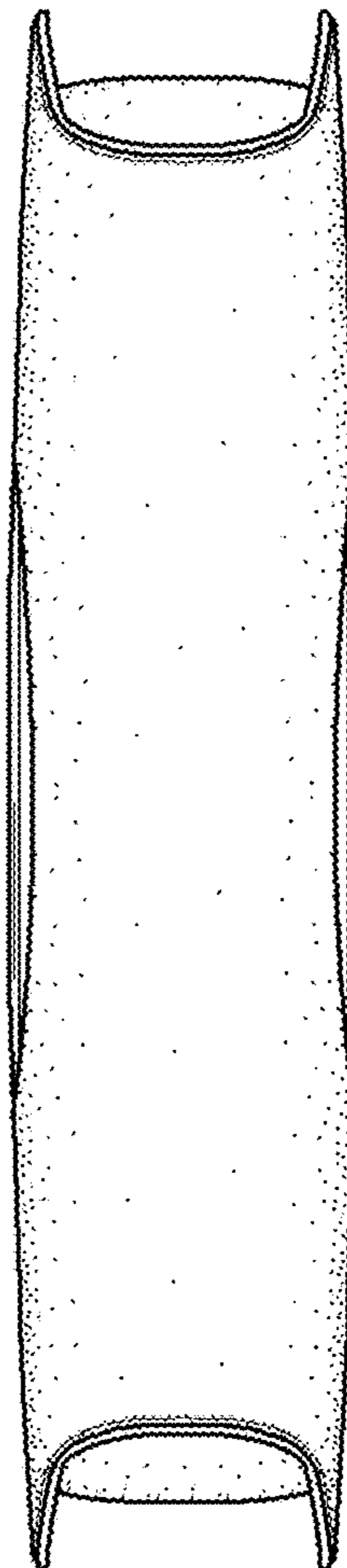

FIG. 6