



US00D808645S

(12) **United States Design Patent**
Wood

(10) **Patent No.:** **US D808,645 S**

(45) **Date of Patent:** **** Jan. 30, 2018**

(54) **SEA SHELLING BAG**

(71) Applicant: **Nancy C. Wood**, Westbrook, CT (US)

(72) Inventor: **Nancy C. Wood**, Westbrook, CT (US)

(**) Term: **15 Years**

(21) Appl. No.: **29/584,937**

(22) Filed: **Nov. 18, 2016**

(51) **LOC (11) Cl.** **03-01**

(52) **U.S. Cl.**
USPC **D3/226**

(58) **Field of Classification Search**
USPC D3/226, 221, 229, 228, 243, 303;
190/903; 2/247, 300; 224/223, 240, 245,
224/674, 677, 664, 681, 683; 383/10, 15,
383/37-39
CPC A45C 1/04; A45F 3/00; A45F 3/005
See application file for complete search history.

(56) **References Cited**

U.S. PATENT DOCUMENTS

2,474,495 A * 6/1949 Pollak A45C 1/04
224/240
D328,525 S * 8/1992 Wilson D3/303
5,209,385 A * 5/1993 Ledesma A45C 1/04
224/223
D352,166 S * 11/1994 Caligiuri D3/243
D416,676 S * 11/1999 Fitzgerald D3/226

D464,192 S * 10/2002 Fairbairn D3/215
D504,770 S * 5/2005 Tobin D3/221
D658,871 S * 5/2012 Voit D3/226
D711,651 S * 8/2014 Koenig D3/303

* cited by examiner

Primary Examiner — Catherine R Oliver-Garcia

(74) *Attorney, Agent, or Firm* — Dunlap Bennett &
Ludwig PLLC; Brendan E. Squire

(57) **CLAIM**

The ornamental design for a sea shelling bag, as shown and described.

DESCRIPTION

FIG. 1 is a front perspective view of the sea shelling bag showing my new design;
FIG. 2 is a front elevation view thereof;
FIG. 3 is a rear elevation view thereof;
FIG. 4 is a left side elevation view thereof;
FIG. 5 is a right side elevation view thereof;
FIG. 6 is a top plan view thereof;
FIG. 7 is a bottom plan view thereof; and,
FIG. 8 is a perspective view showing the sea shelling bag in use.

The broken lines shown in the drawings illustrate portions of the sea shelling bag that form no part of the claimed design. The broken lines in FIG. 8 showing the sea shelling bag in use illustrates environment and forms no part of the claimed design.

1 Claim, 4 Drawing Sheets

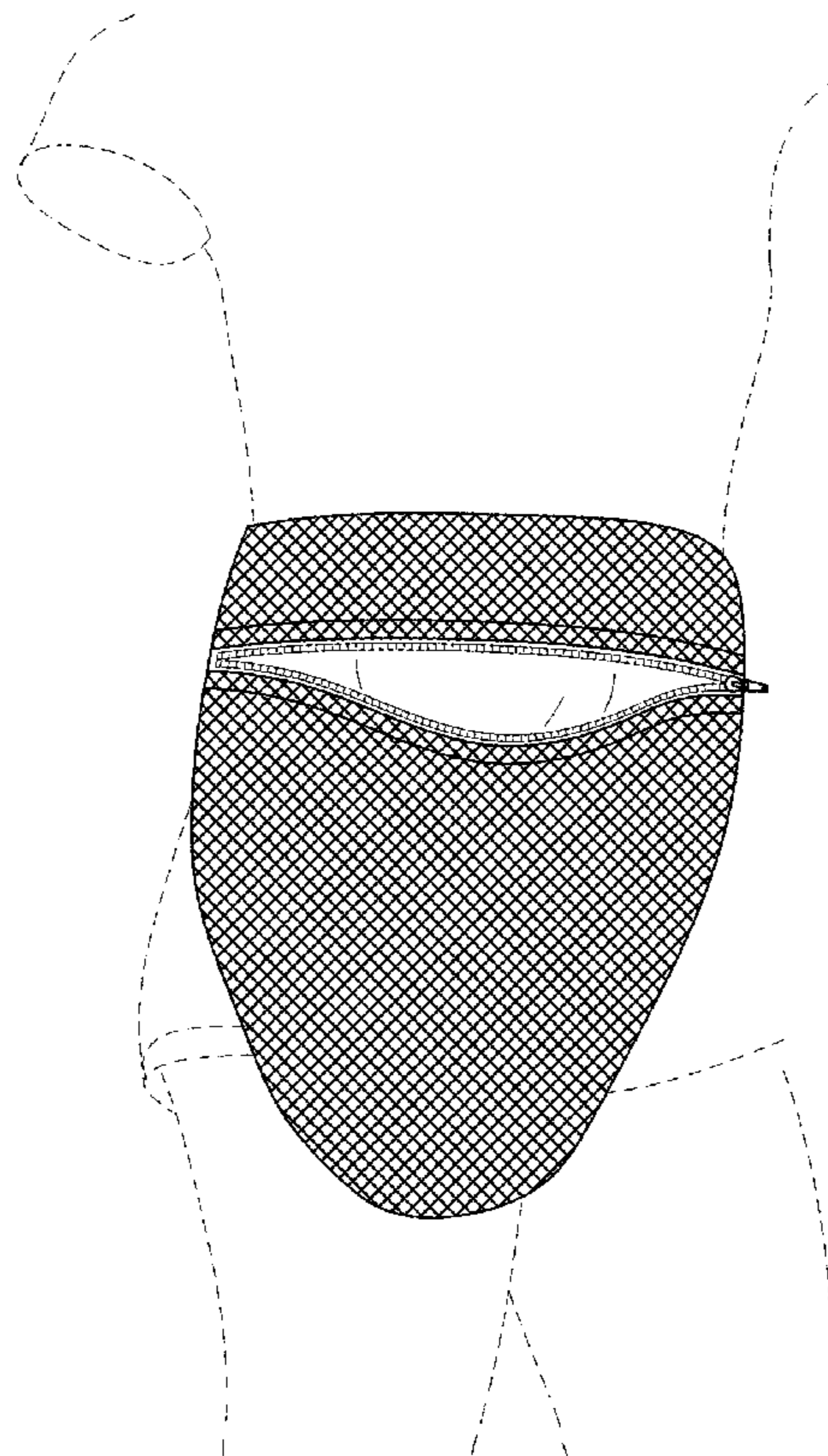

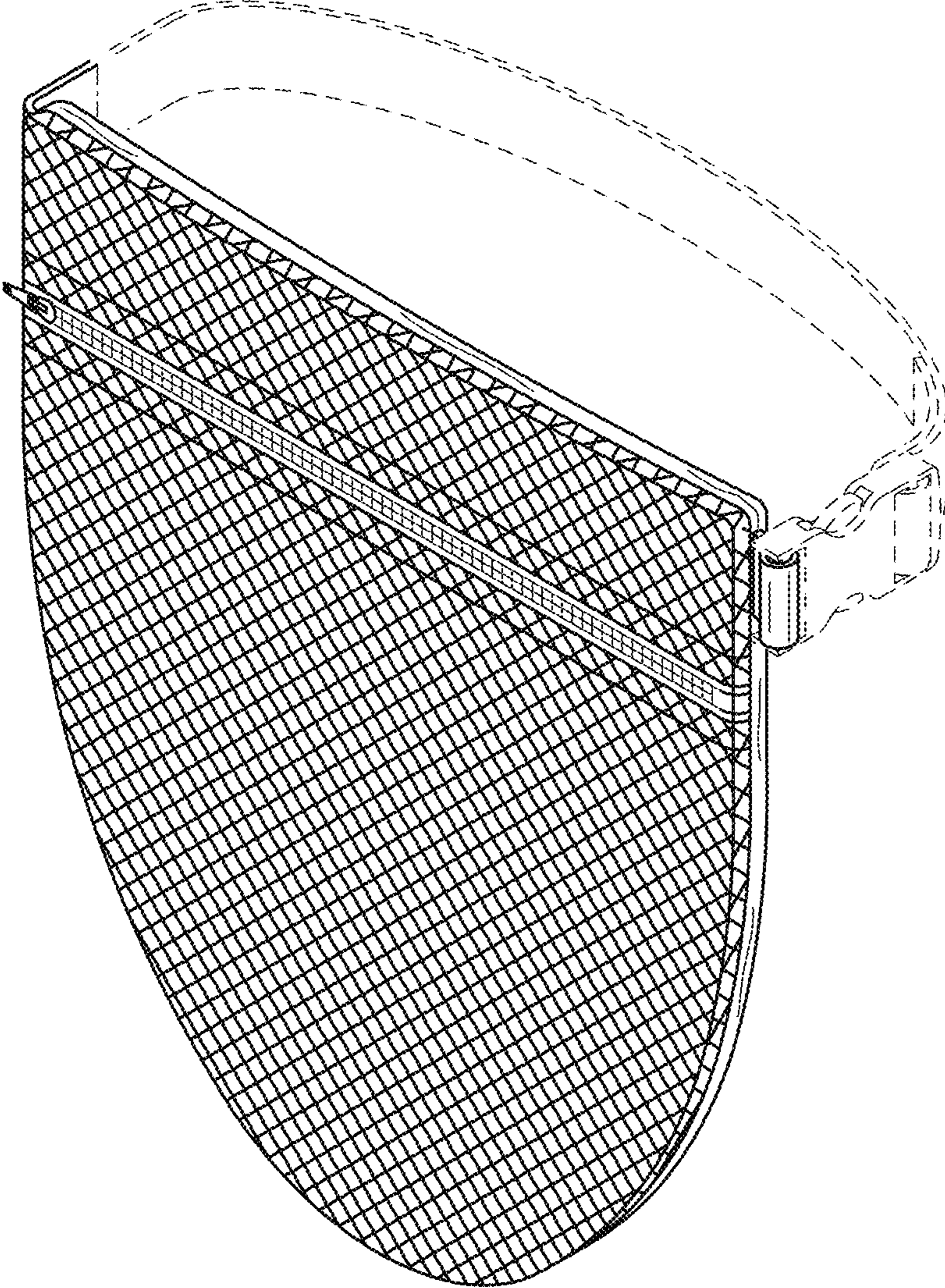

FIG. 1

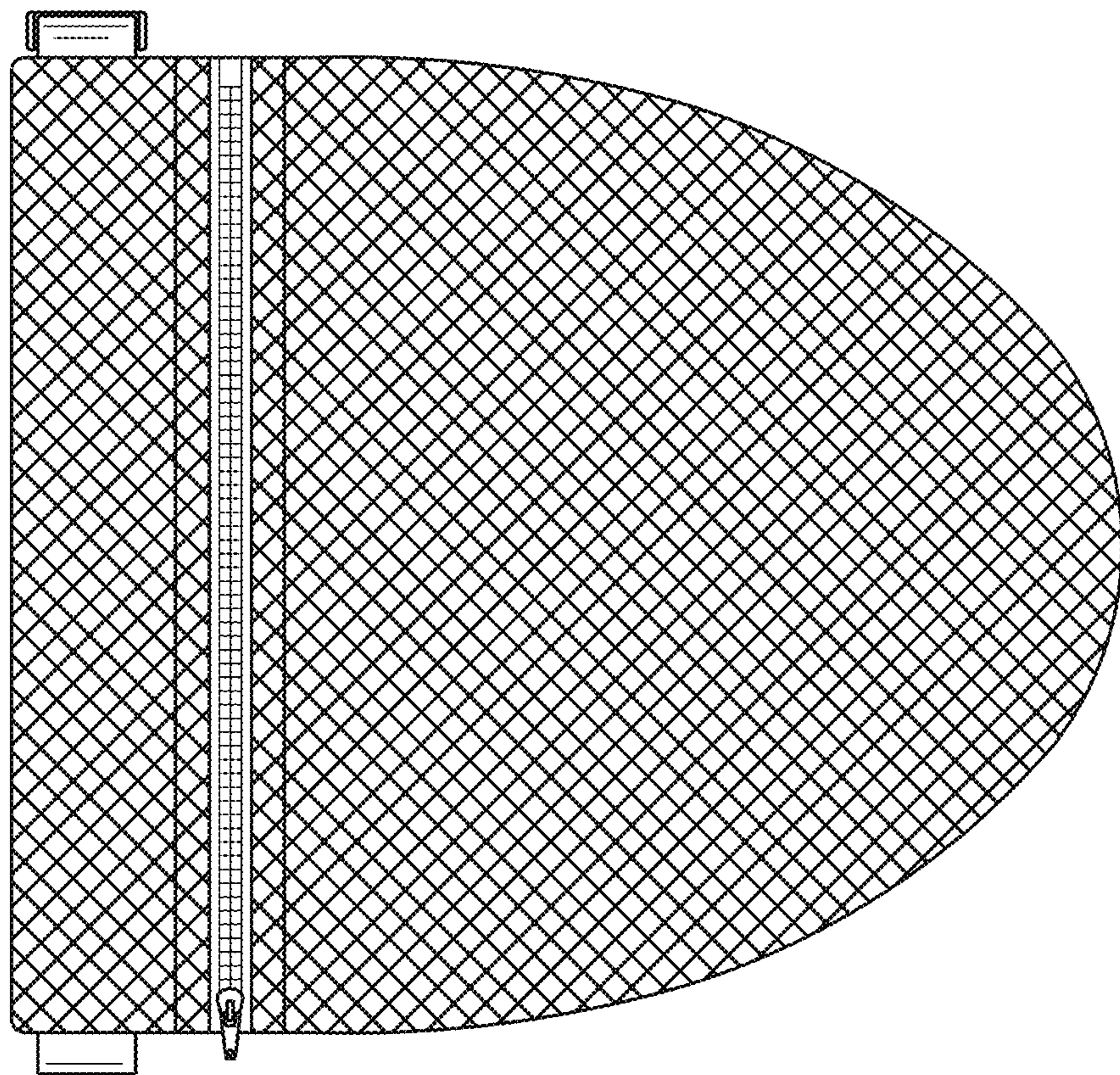
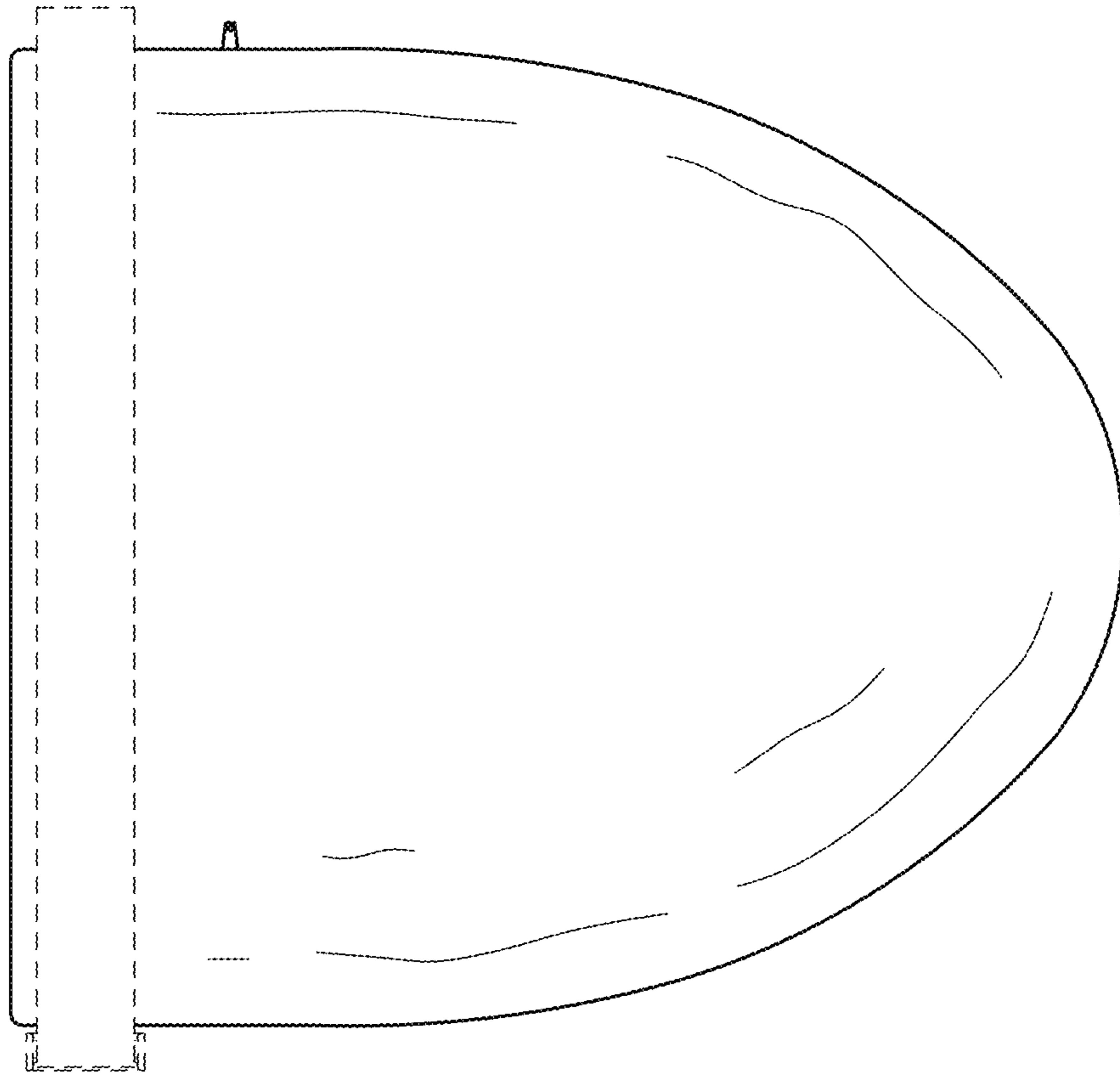
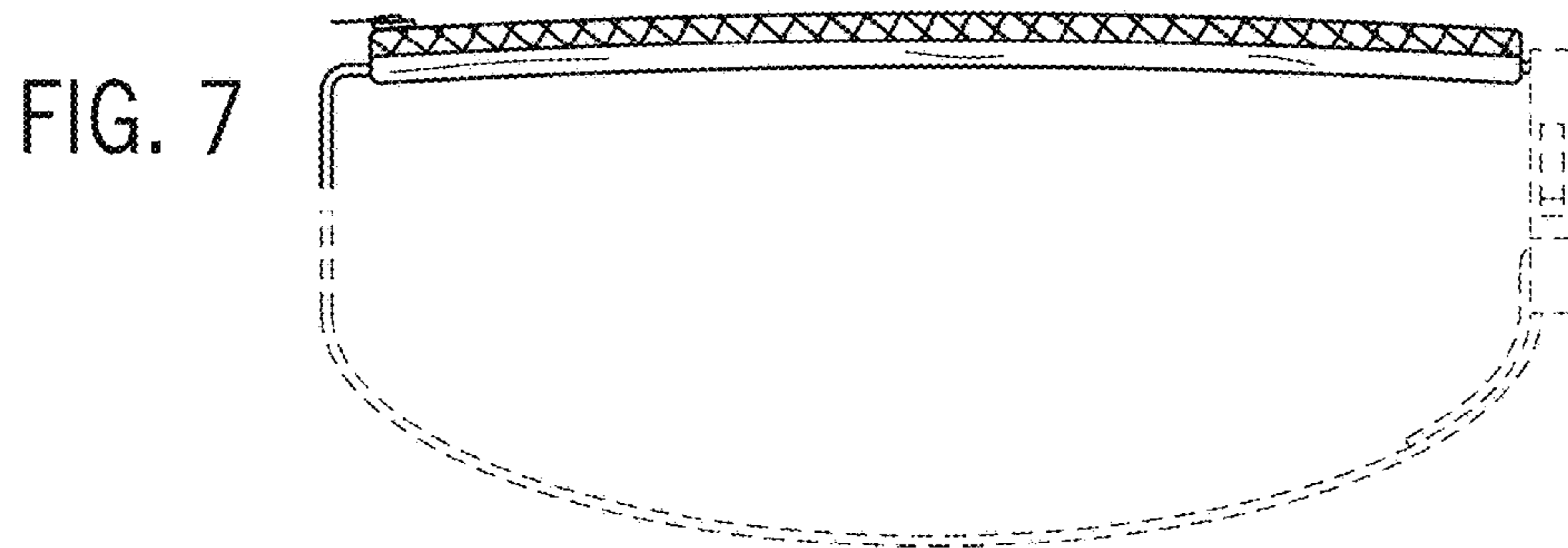
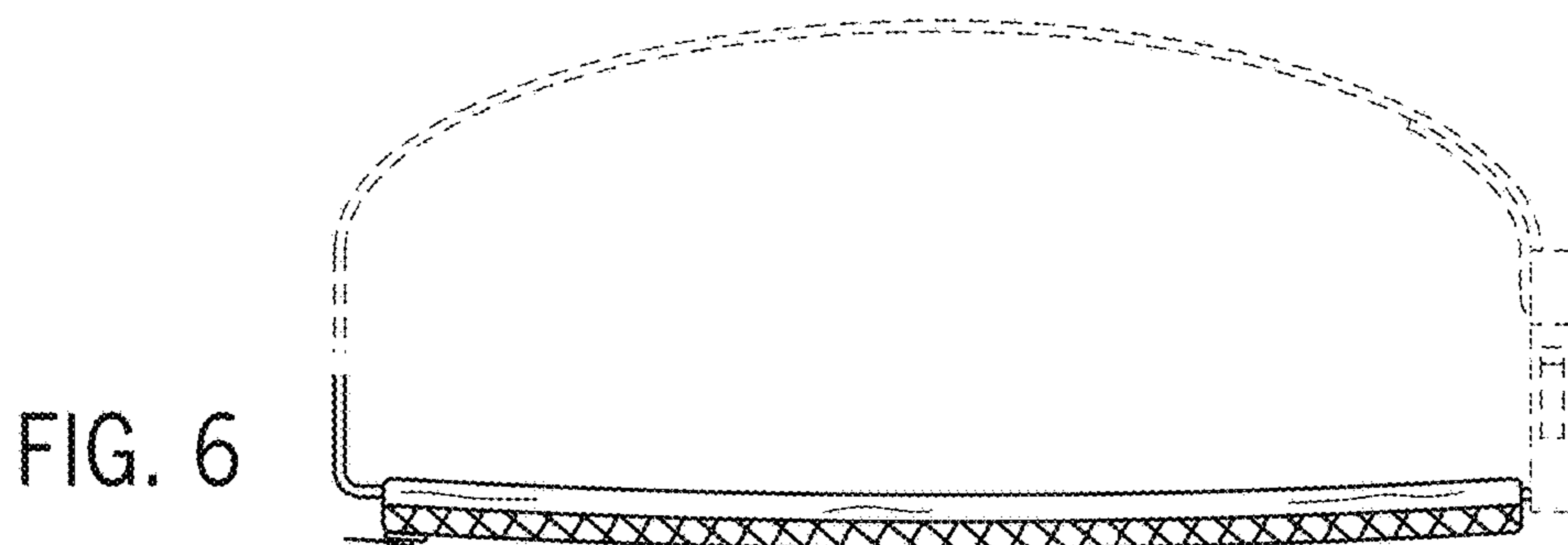
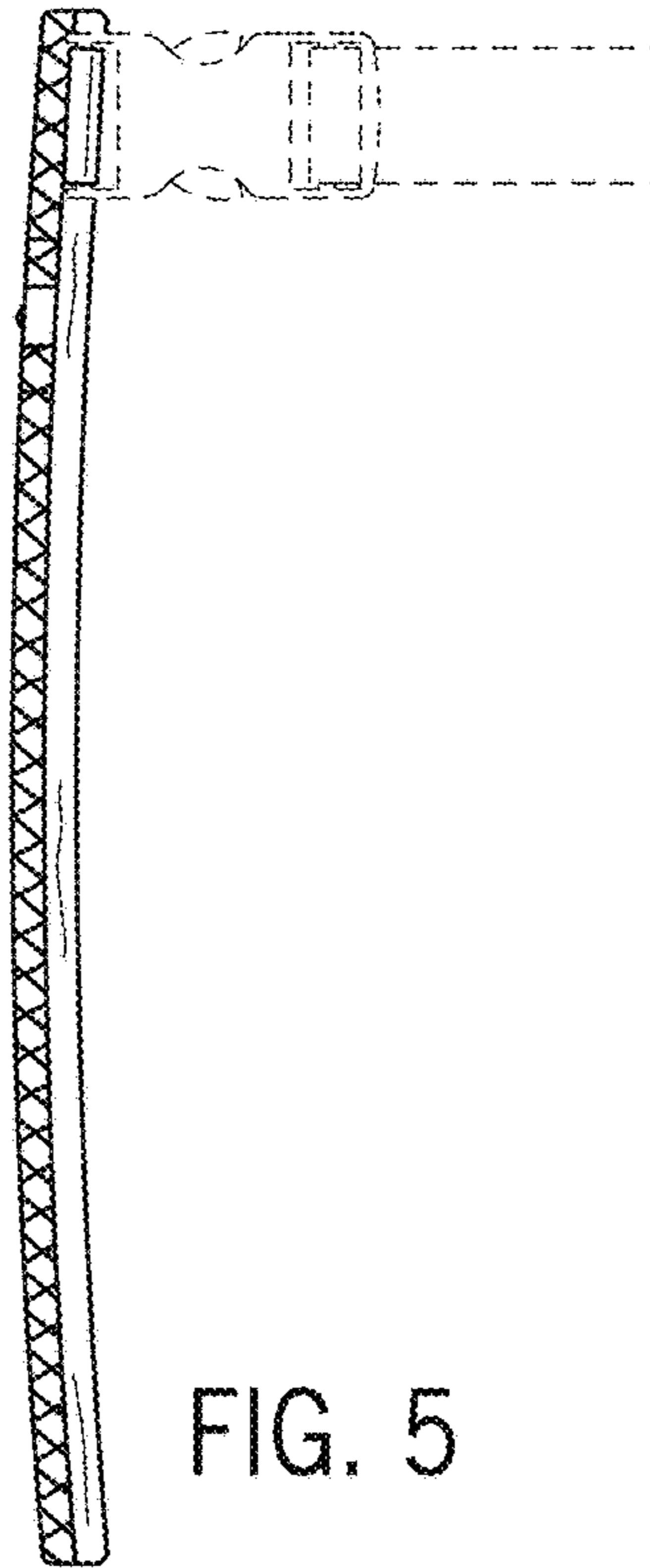
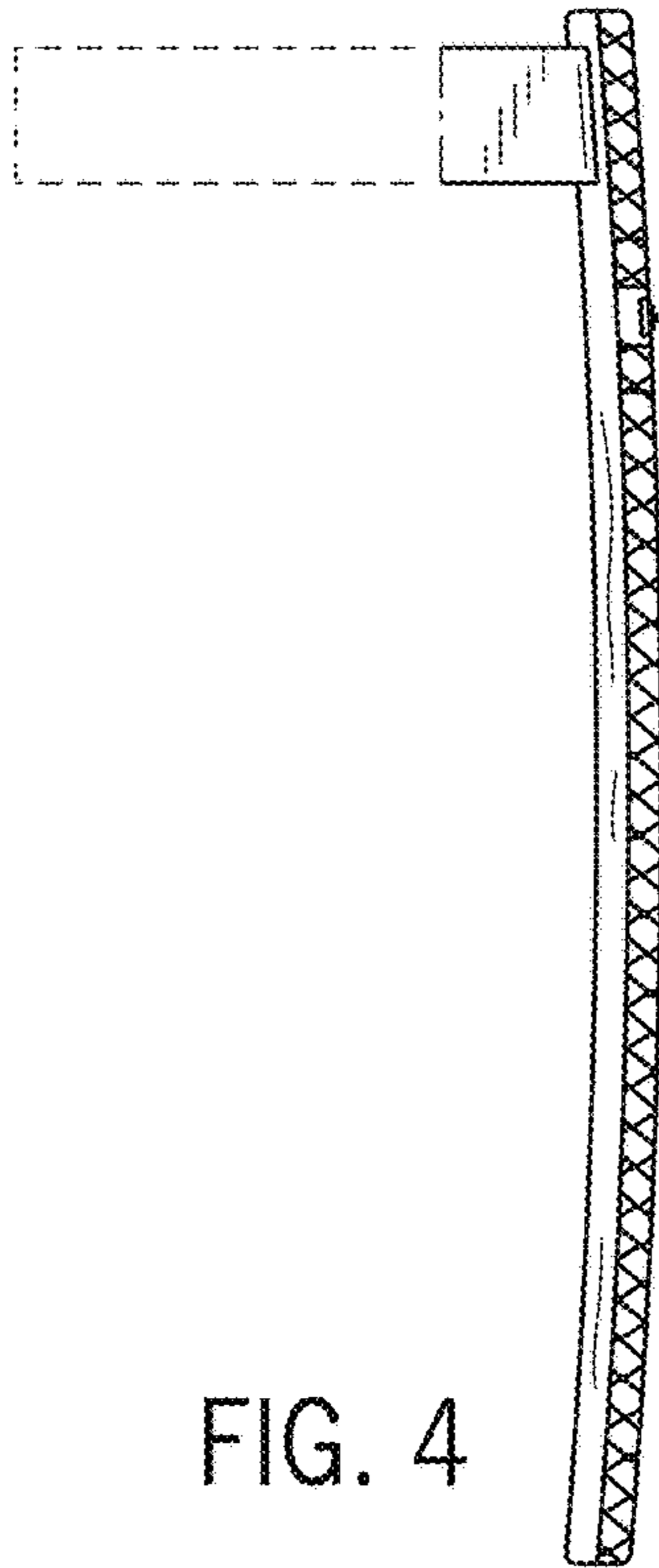

FIG. 2

FIG. 3





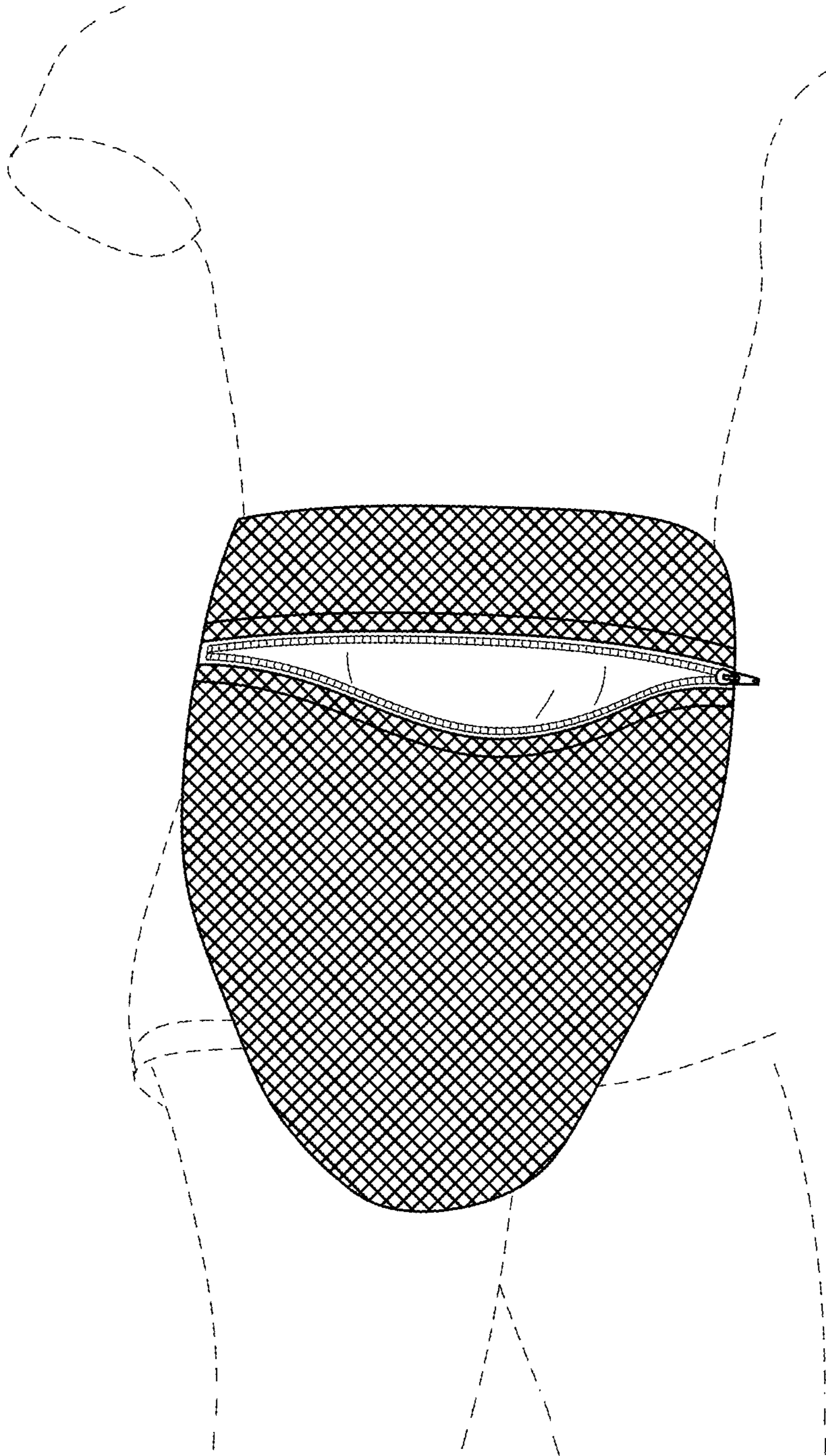

FIG. 8