



US00D808594S

(12) **United States Design Patent**
Tien

(10) **Patent No.:** **US D808,594 S**

(45) **Date of Patent:** **** Jan. 23, 2018**

(54) **QUICK RELEASE BODY ARMOR**
(71) Applicant: **Spencer Tien**, Irwindale, CA (US)
(72) Inventor: **Spencer Tien**, Irwindale, CA (US)

8,826,462 B2 * 9/2014 Storms, Jr. A41D 1/04
2/102
8,898,914 B2 * 12/2014 Bruder F41G 1/467
124/87
D766,514 S * 9/2016 Deng D29/101.4

(**) Term: **15 Years**

* cited by examiner

(21) Appl. No.: **29/587,159**

Primary Examiner — Randall H Gholson

(22) Filed: **Dec. 9, 2016**

(74) *Attorney, Agent, or Firm* — Clement Cheng

(51) **LOC (11) Cl.** **29-02**

(52) **U.S. Cl.**

USPC **D29/101.4**

(58) **Field of Classification Search**

USPC D29/100, 101, 101.2, 101.3, 101.4, 122,
D29/124; D2/626, 829, 830, 860;
362/108; D21/805; 441/88, 106, 108,
441/111, 117; 182/3; 2/48, 51, 92, 102,
2/103, 105, 913, 914, 915

CPC A41D 1/00; A45F 3/00

See application file for complete search history.

(57) **CLAIM**

The ornamental design for a quick release body armor, as shown and described.

DESCRIPTION

FIG. 1 is a perspective view.

FIG. 2 is a front view.

FIG. 3 is a rear view.

FIG. 4 is a left side view.

FIG. 5 is a right side view.

FIG. 6 is a top view; and,

FIG. 7 is a bottom view.

The broken lines in the drawings show unclaimed subject matter only and form no part of the claimed design.

(56) **References Cited**

U.S. PATENT DOCUMENTS

7,424,748 B1 * 9/2008 McDunn F41H 5/013
2/102
8,353,065 B1 * 1/2013 Crye F41H 1/02
2/102

1 Claim, 6 Drawing Sheets

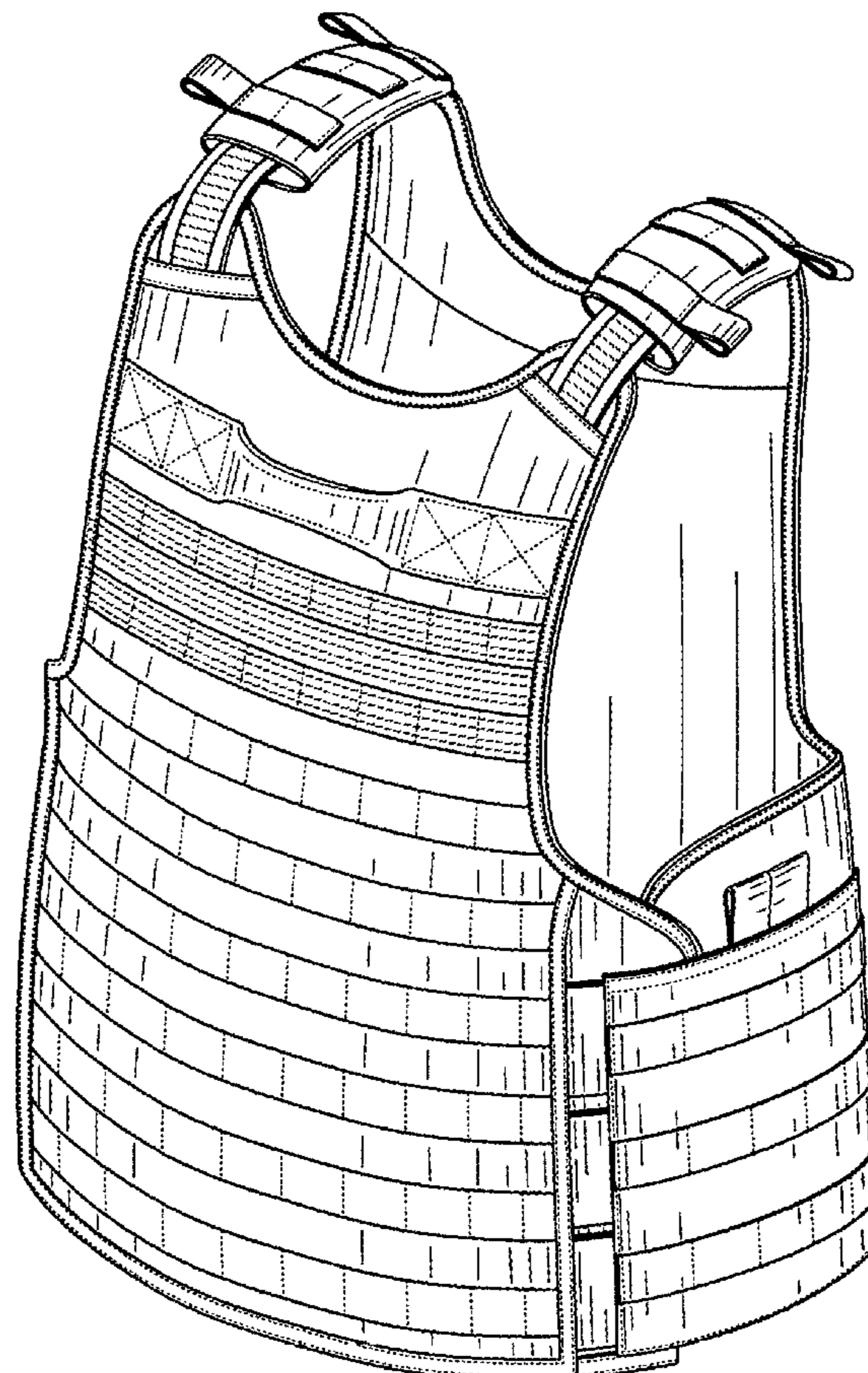

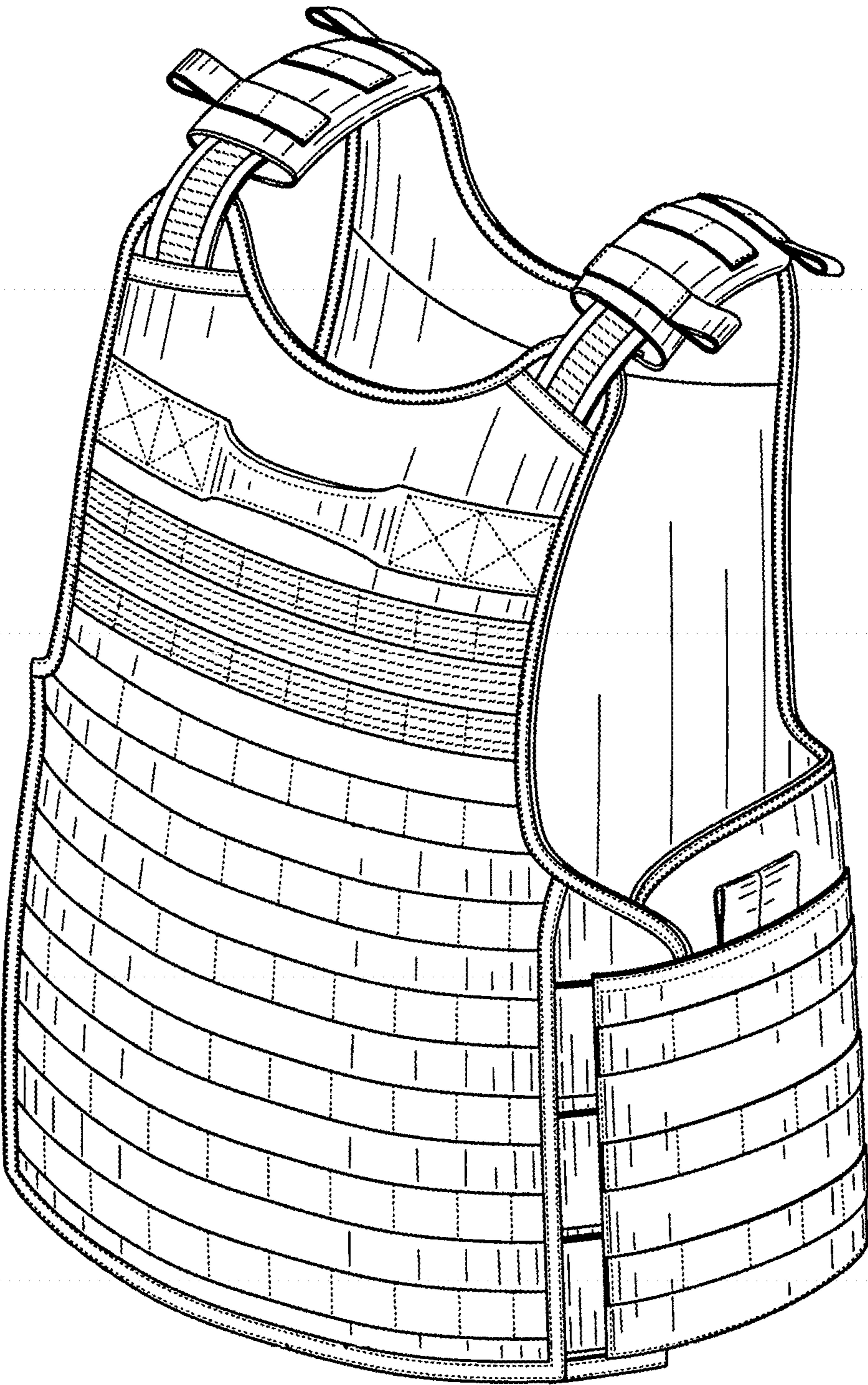

FIG. 1

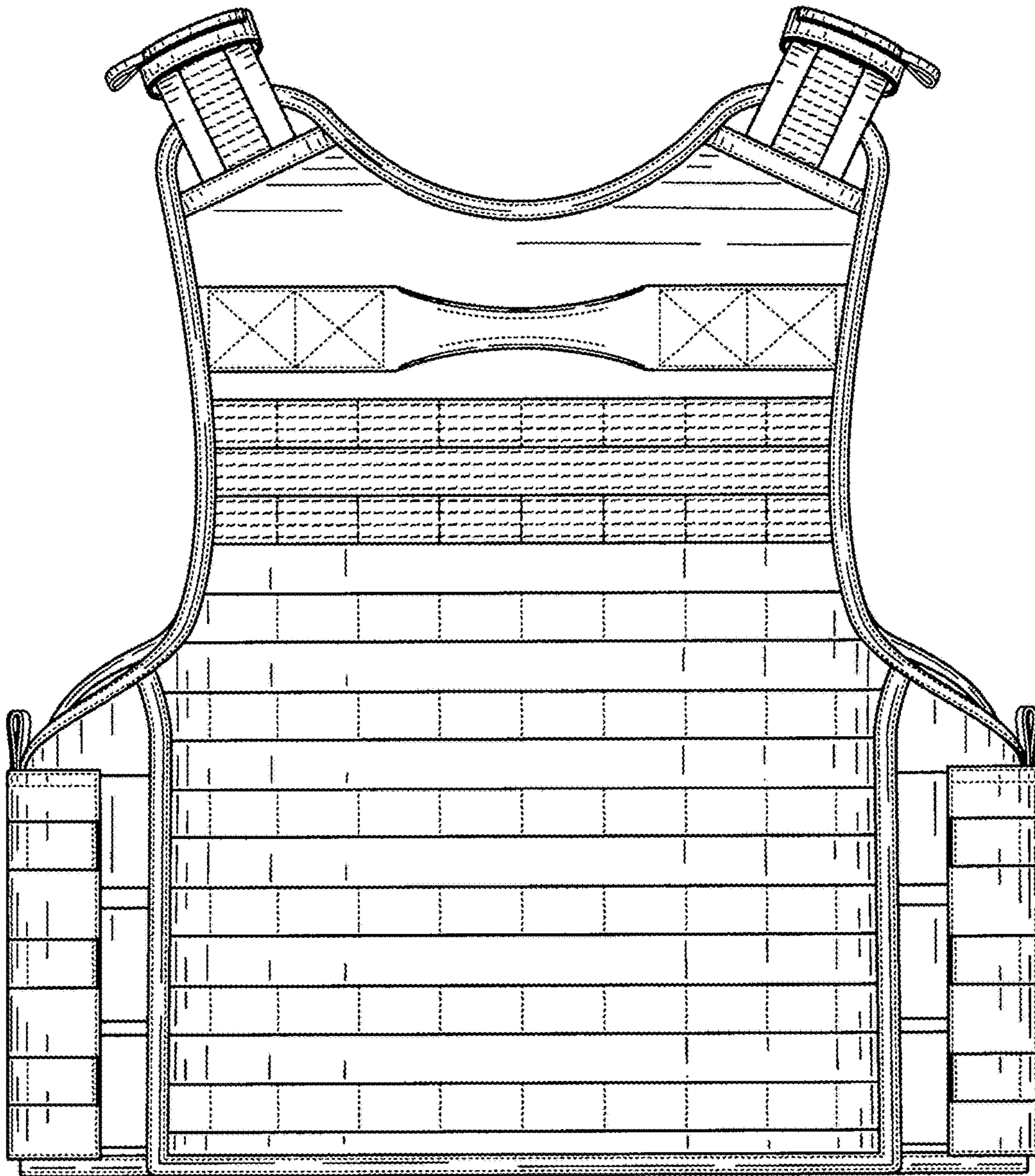

FIG. 2

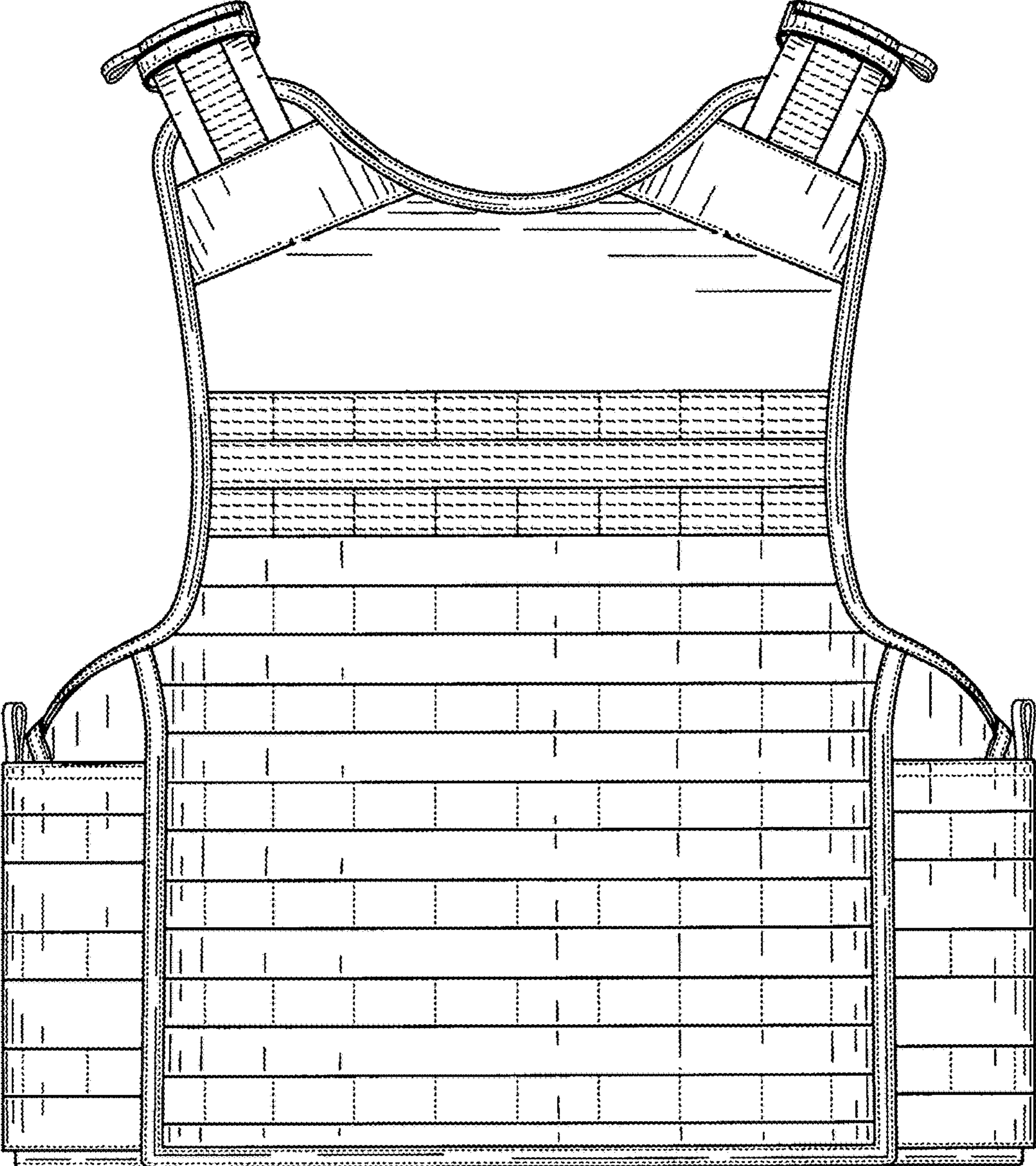

FIG. 3

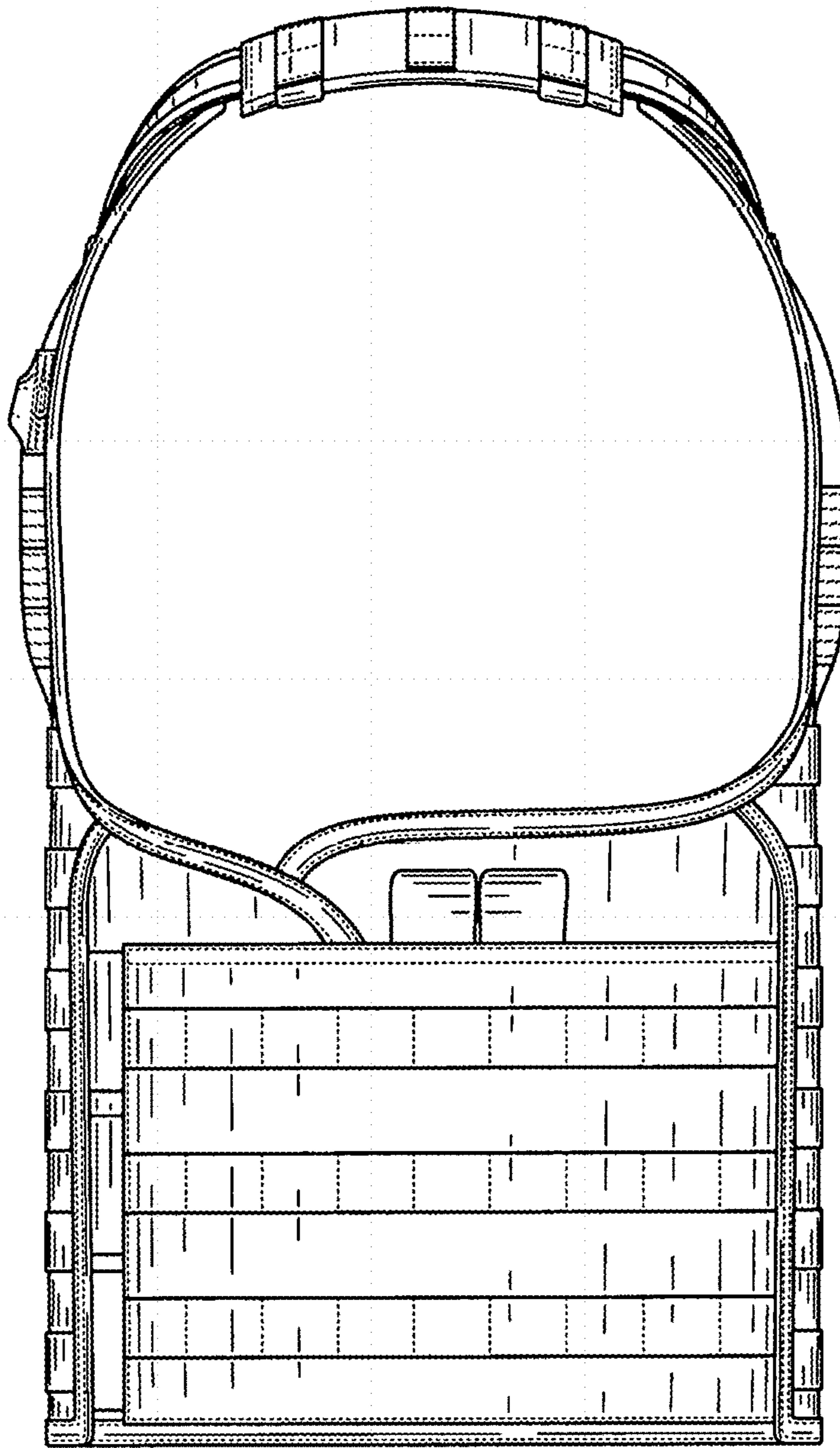

FIG. 4

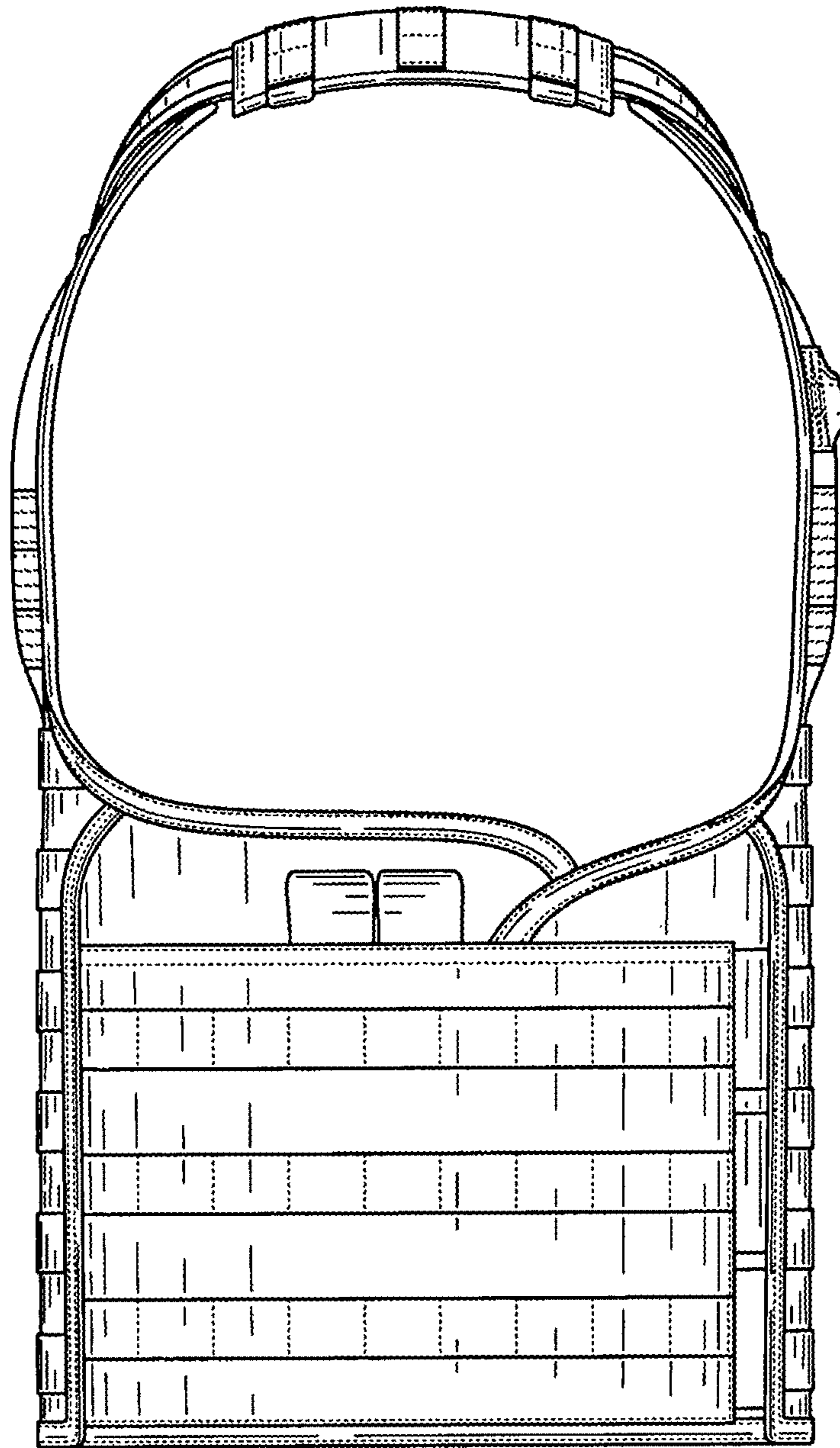

FIG. 5

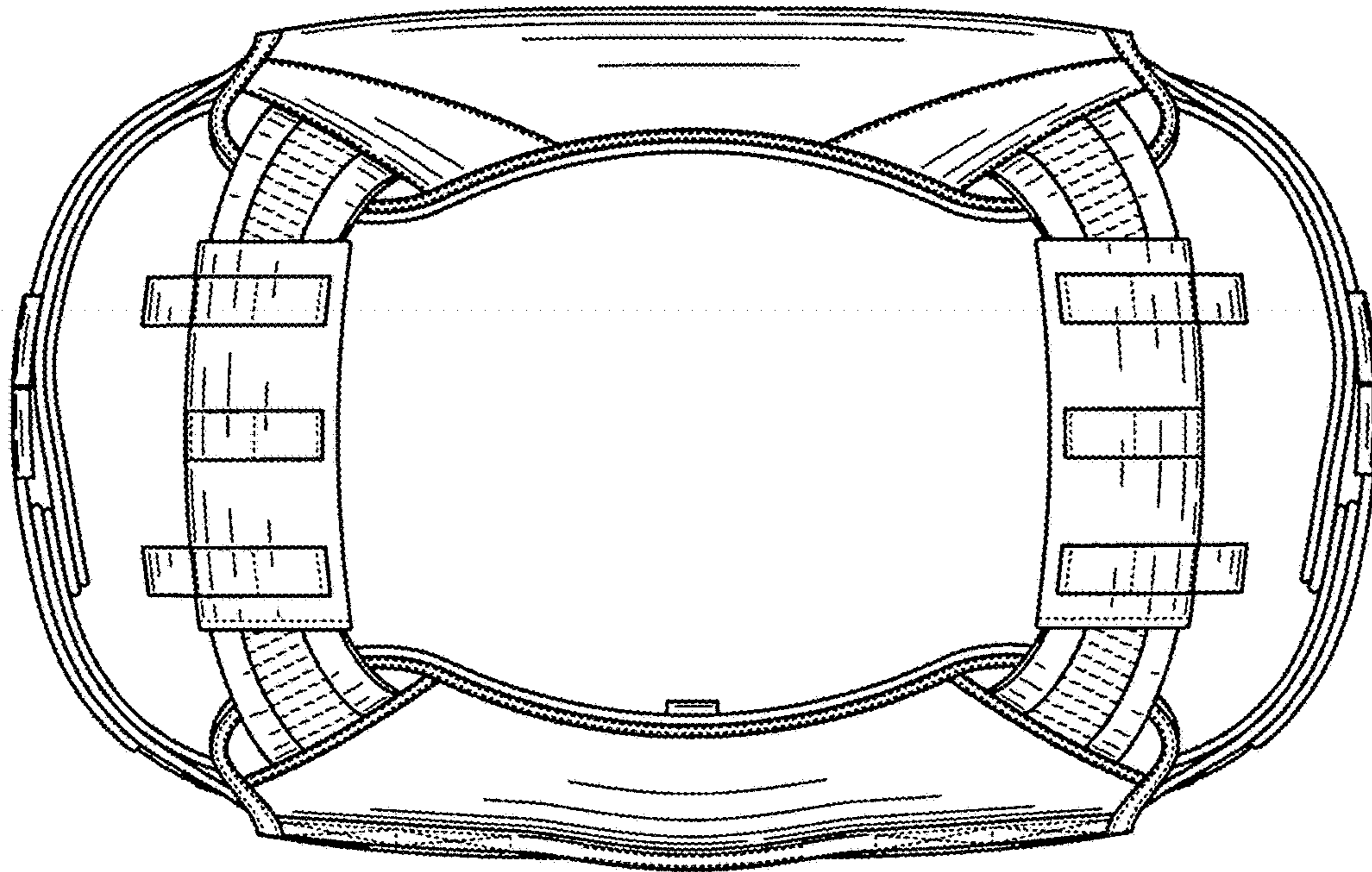

FIG. 6

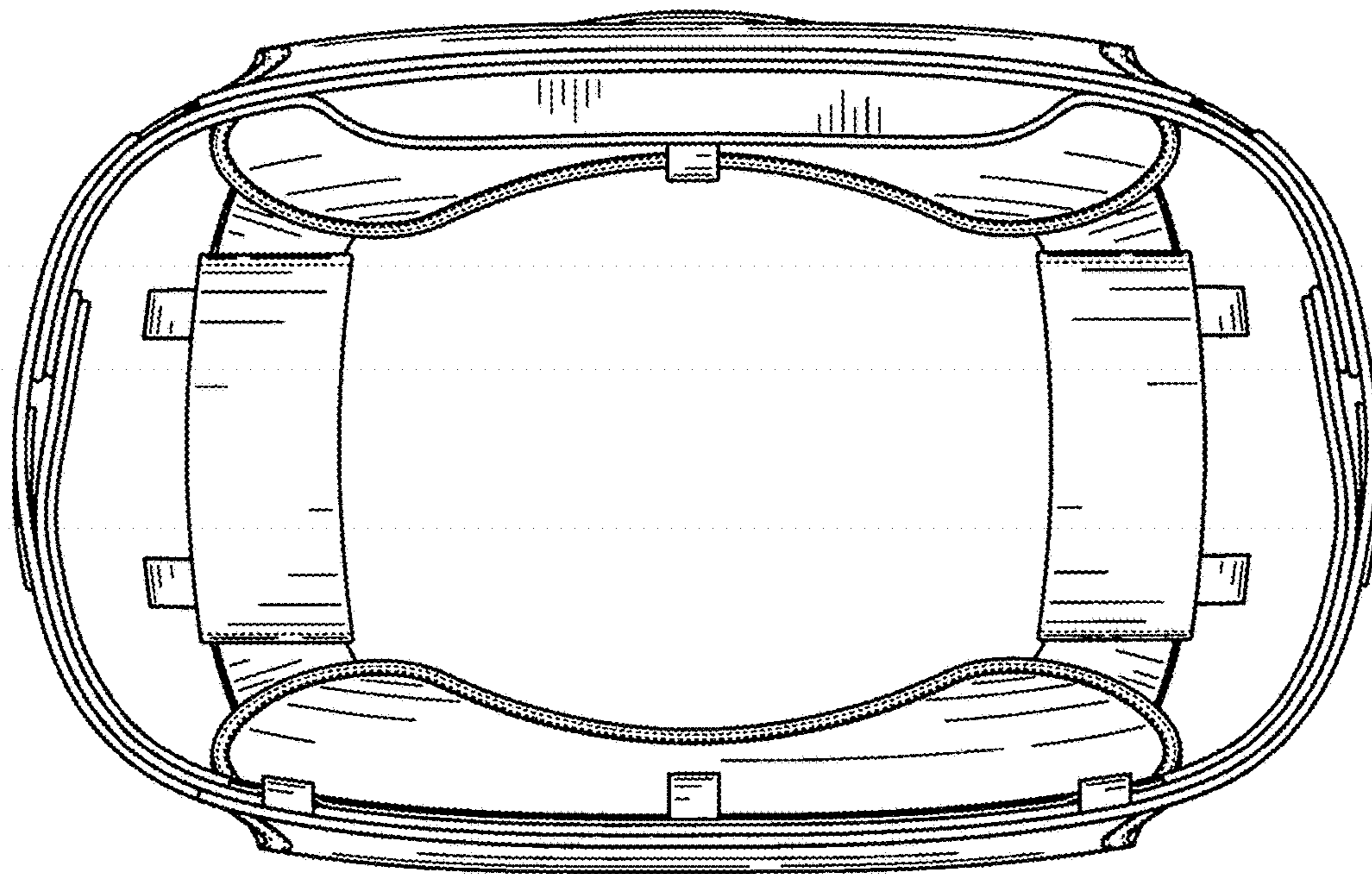

FIG. 7