



US00D808521S

(12) **United States Design Patent**
Bottom et al.

(10) **Patent No.:** **US D808,521 S**
(45) **Date of Patent:** **** Jan. 23, 2018**

(54) **BOUGIE**

(71) Applicant: **Intersurgical AG**, Vaduz (LI)

(72) Inventors: **David Simon Bottom**, Wokingham (GB); **Andrew Neil Miller**, Crowthorne (GB); **Richard Levitan**, Orford, NH (US)

(73) Assignee: **Intersurgical AG**, Vaduz (LI)

(**) Term: **15 Years**

(21) Appl. No.: **29/583,389**

(22) Filed: **Nov. 4, 2016**

(51) **LOC (11) Cl.** **24-02**

(52) **U.S. Cl.**
USPC **D24/127**

(58) **Field of Classification Search**
USPC D24/108, 112, 113, 114, 127, 128, 129,
D24/130, 133, 141, 146, 147, 152, 186,
(Continued)

(56) **References Cited**

U.S. PATENT DOCUMENTS

D344,131 S * 2/1994 Hubbell D24/107
5,766,202 A * 6/1998 Jones A61M 29/00
604/270

(Continued)

OTHER PUBLICATIONS

Armstrong Medical, AviAir Intubating bougie, undated online product page, retrieved Aug. 22, 2017 from URL:<http://www.armstrongmedical.net/anaesthesia/airway-management/aviair>.*

(Continued)

Primary Examiner — Sheryl Lane
Assistant Examiner — Calvin E Vansant

(74) *Attorney, Agent, or Firm* — LeClairRyan, a Professional Corporation

(57) **CLAIM**

The ornamental design for a bougie, as shown and described.

DESCRIPTION

FIG. 1 is a right front perspective view of a bougie.
FIG. 2 is a left side view of the bougie shown in FIG. 1.
FIG. 3 is a bottom plan view of the bougie shown in FIG. 1.
FIG. 4 is a front view of the bougie shown in FIG. 1.
FIG. 5 is an enlarged view of the curved tip of the bougie shown in FIG. 1.
FIG. 6 is an enlarged view of the flat tip of the bougie shown in FIG. 1.
FIG. 7 is an enlarged cut away view of the main body of the bougie shown in FIG. 1.
FIG. 8 is a right front perspective view of a second embodiment of a bougie.
FIG. 9 is a left side view of the bougie shown in FIG. 8.
FIG. 10 is a bottom plan view of the bougie shown in FIG. 8.
FIG. 11 is a front view of the bougie shown in FIG. 8.
FIG. 12 is an enlarged view of the curved tip of the bougie shown in FIG. 8.
FIG. 13 is an enlarged view of the flat tip of the bougie shown in FIG. 8.
FIG. 14 is a right front perspective view of a third embodiment of a bougie.
FIG. 15 is a left side view of the bougie shown in FIG. 14.
FIG. 16 is a bottom plan view of the bougie shown in FIG. 14.
FIG. 17 is a front view of the bougie shown in FIG. 14; and, FIG. 18 is a rear view of the bougie shown in FIG. 14.
The broken lines represent portions of the bougie that form no part of the claimed design.

1 Claim, 18 Drawing Sheets

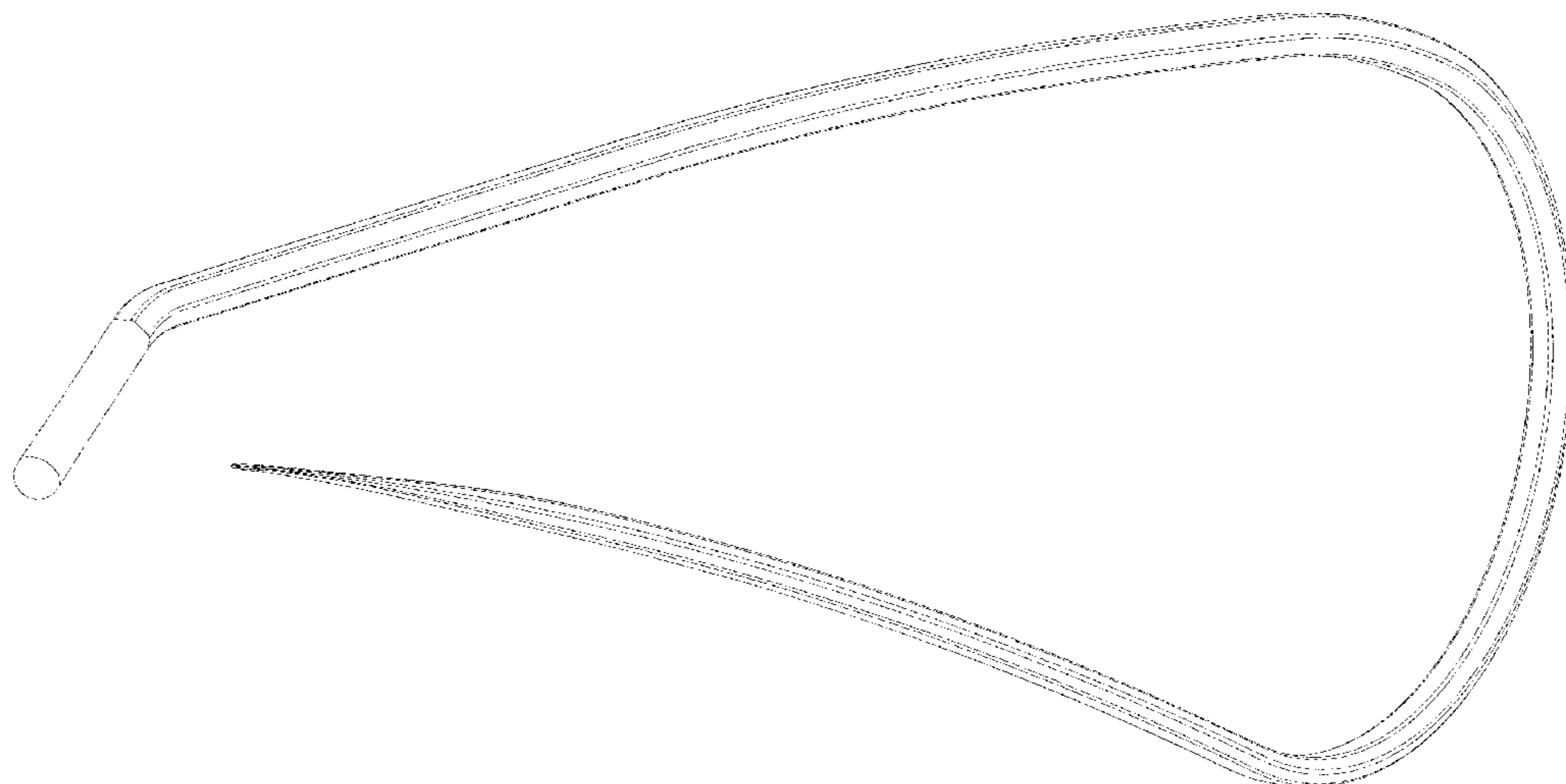

(58) **Field of Classification Search**

USPC D24/214, 215; D23/129, 223, 249, 259,
D23/262
CPC .. A61M 2005/1583; A61M 2005/3227; A61M
25/0136; A61M 25/0606; A61M 25/0612;
A61M 25/0637; A61M 25/0631; A61M
5/158; A61M 5/1582; A61M 5/3243;
A61B 1/00094; A61F 2002/9517
See application file for complete search history.

D772,408 S * 11/2016 Alexander D24/135
D787,057 S * 5/2017 Khouri D24/147
D792,589 S * 7/2017 Alexander D24/135
2005/0090890 A1 4/2005 Wu et al.
2005/0267448 A1 12/2005 Bonnet et al.
2007/0239119 A1* 10/2007 Lipov A61B 17/3417
604/272
2013/0096482 A1 4/2013 Bertrand et al.
2015/0066071 A1* 3/2015 Alexander A61F 5/08
606/199
2015/0290414 A1* 10/2015 Vasan A61M 16/0488
600/191
2017/0196690 A1* 7/2017 Racchini A61F 2/2436

(56) **References Cited**

U.S. PATENT DOCUMENTS

6,010,520 A * 1/2000 Pattison A61M 29/00
606/191
D485,358 S * 1/2004 Woo D24/135
D571,008 S * 6/2008 Wu D24/133
D575,396 S * 8/2008 Wu D24/133
D666,712 S * 9/2012 Laurence D24/130
D752,213 S * 3/2016 Paul D24/127

OTHER PUBLICATIONS

Insight Medical, Tracheal Tube Introducers, online product page,
retrieved Aug. 22, 2017 from URL:[http://www.insightmedical.net/
airway-management/tracheal-tube-introducers/](http://www.insightmedical.net/airway-management/tracheal-tube-introducers/).*

* cited by examiner

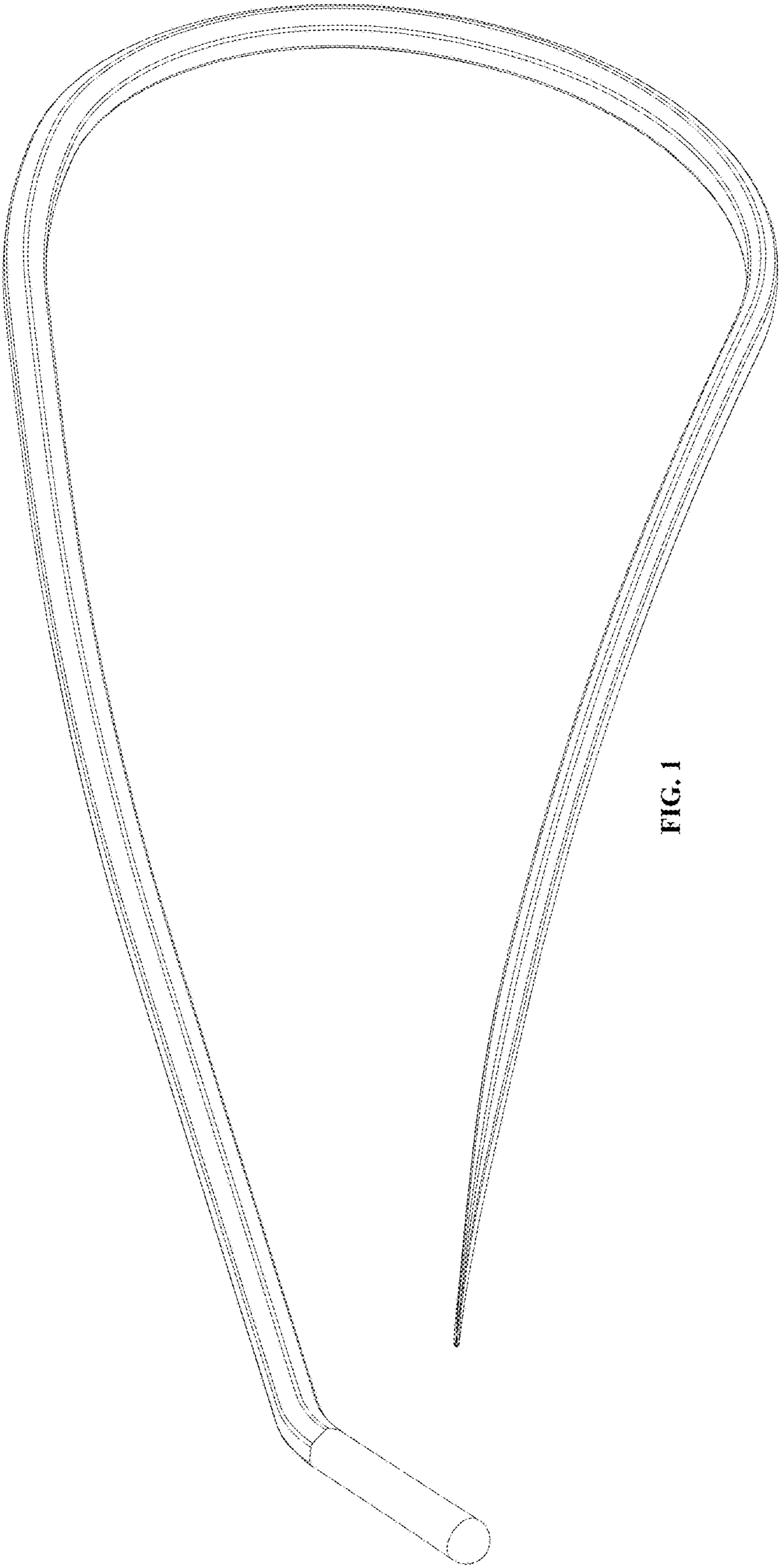

FIG. 1

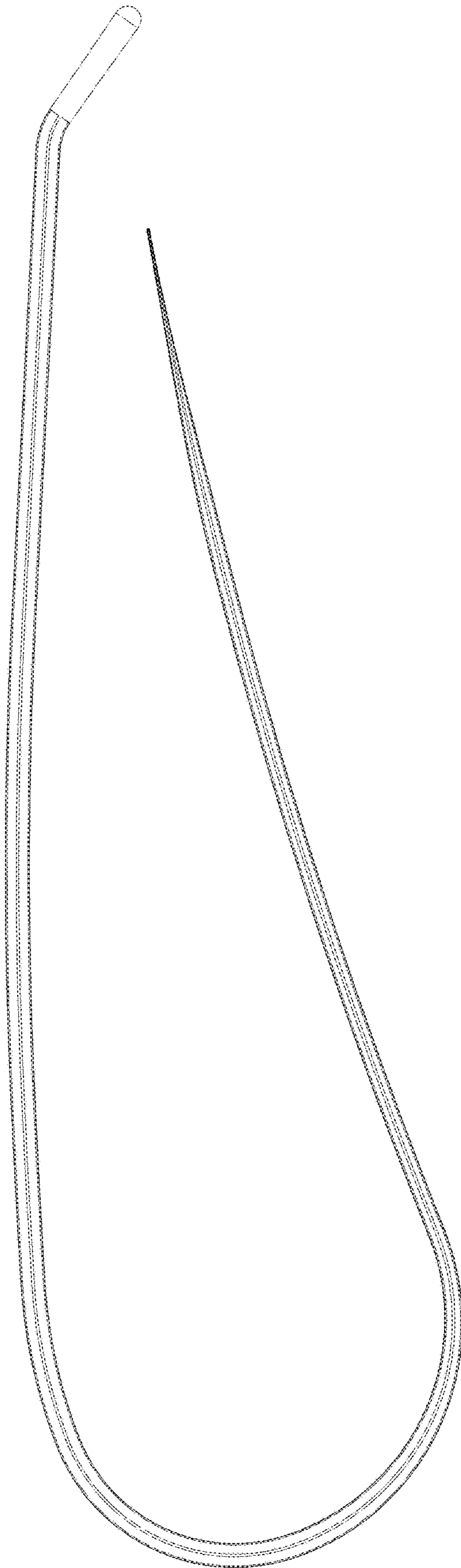

FIG. 2

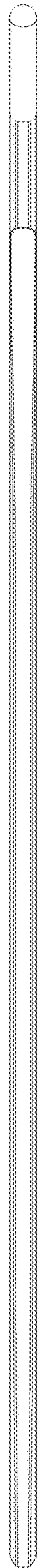

FIG. 3

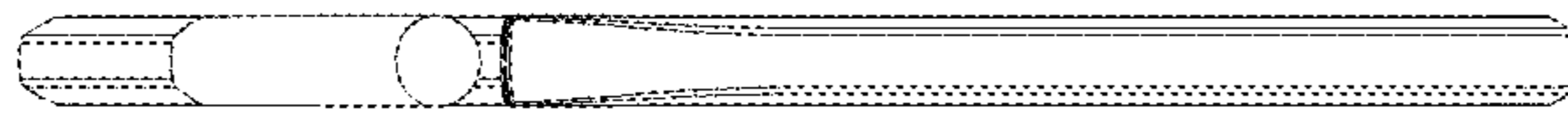

FIG. 4



FIG. 5

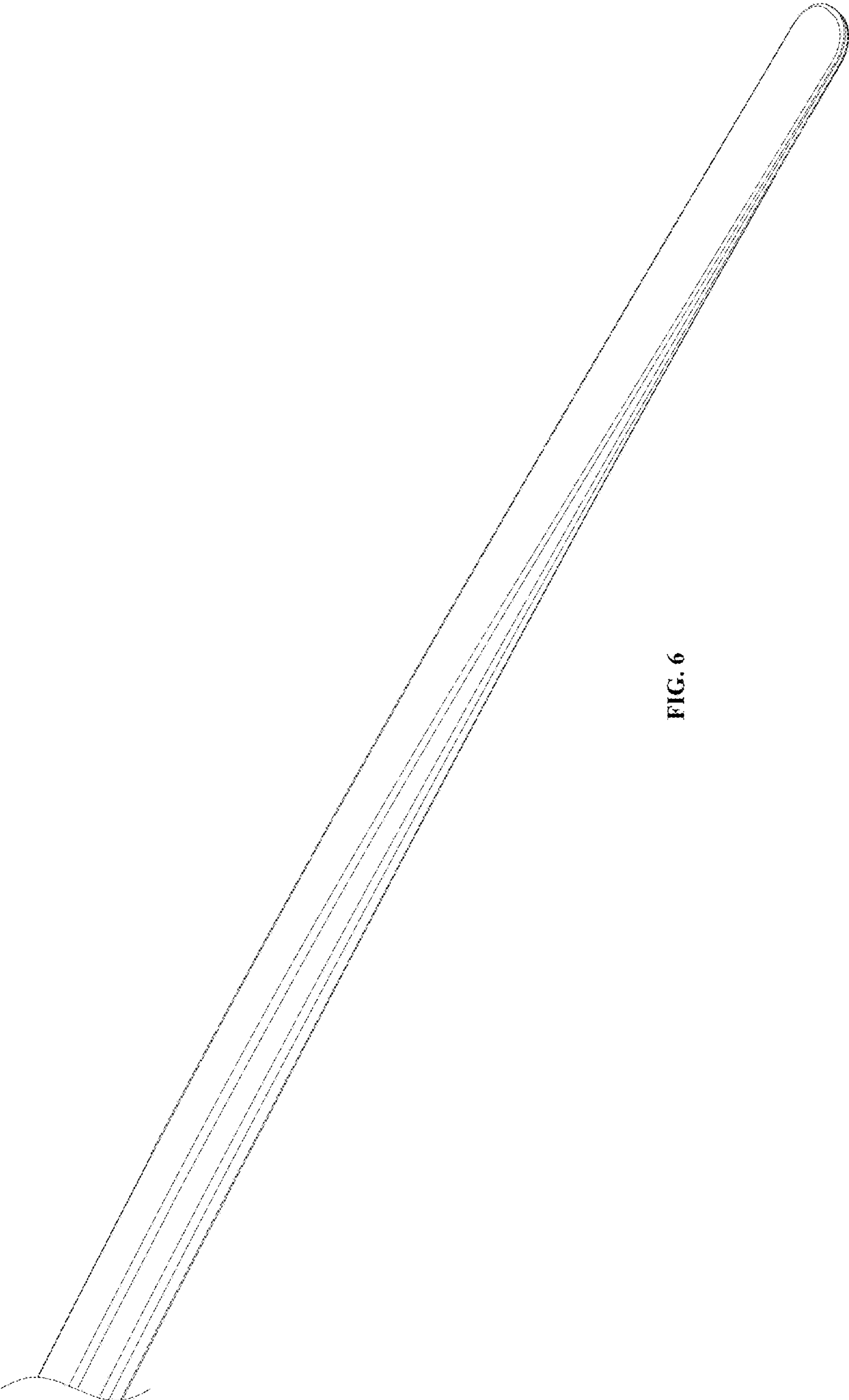

FIG. 6

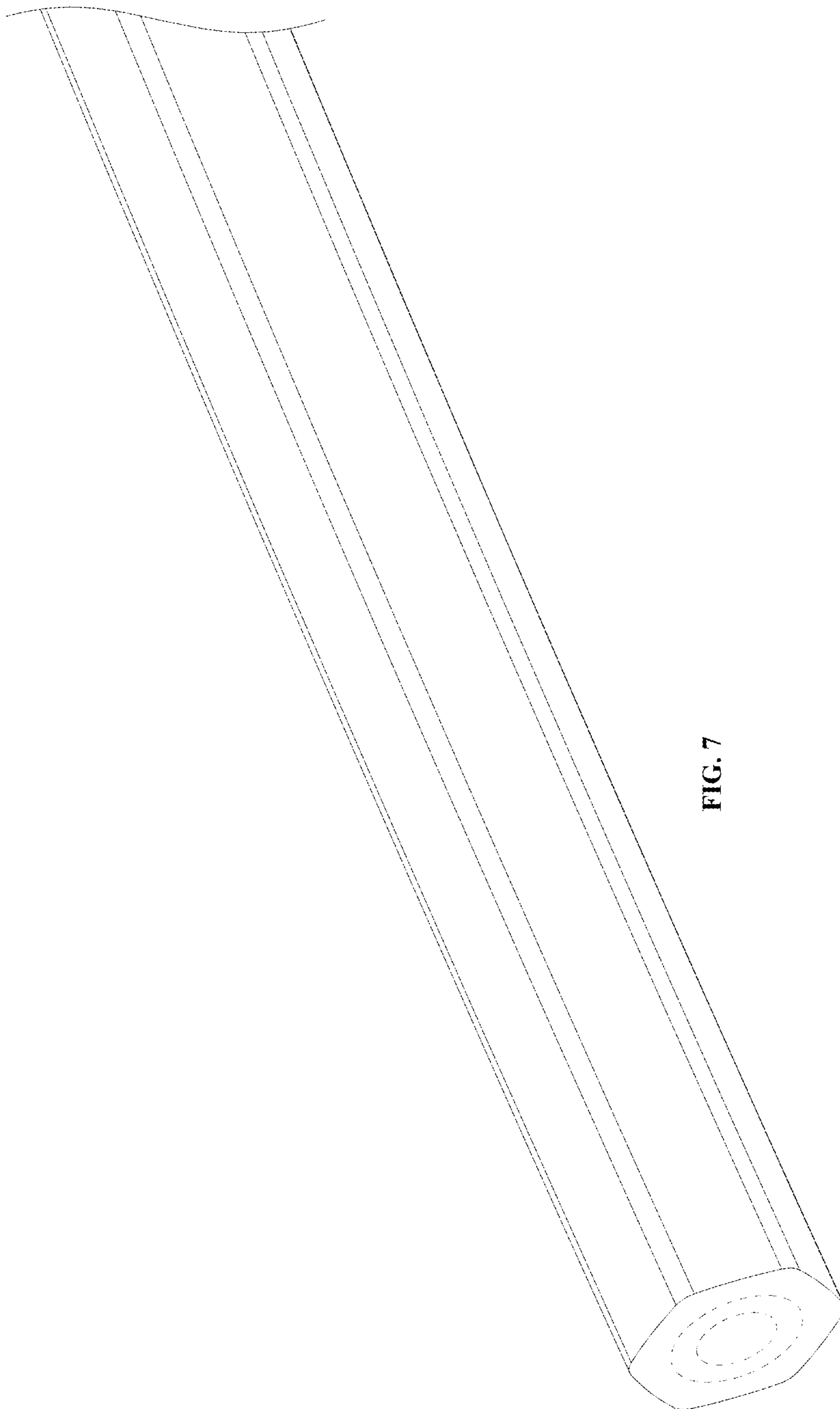

FIG. 7

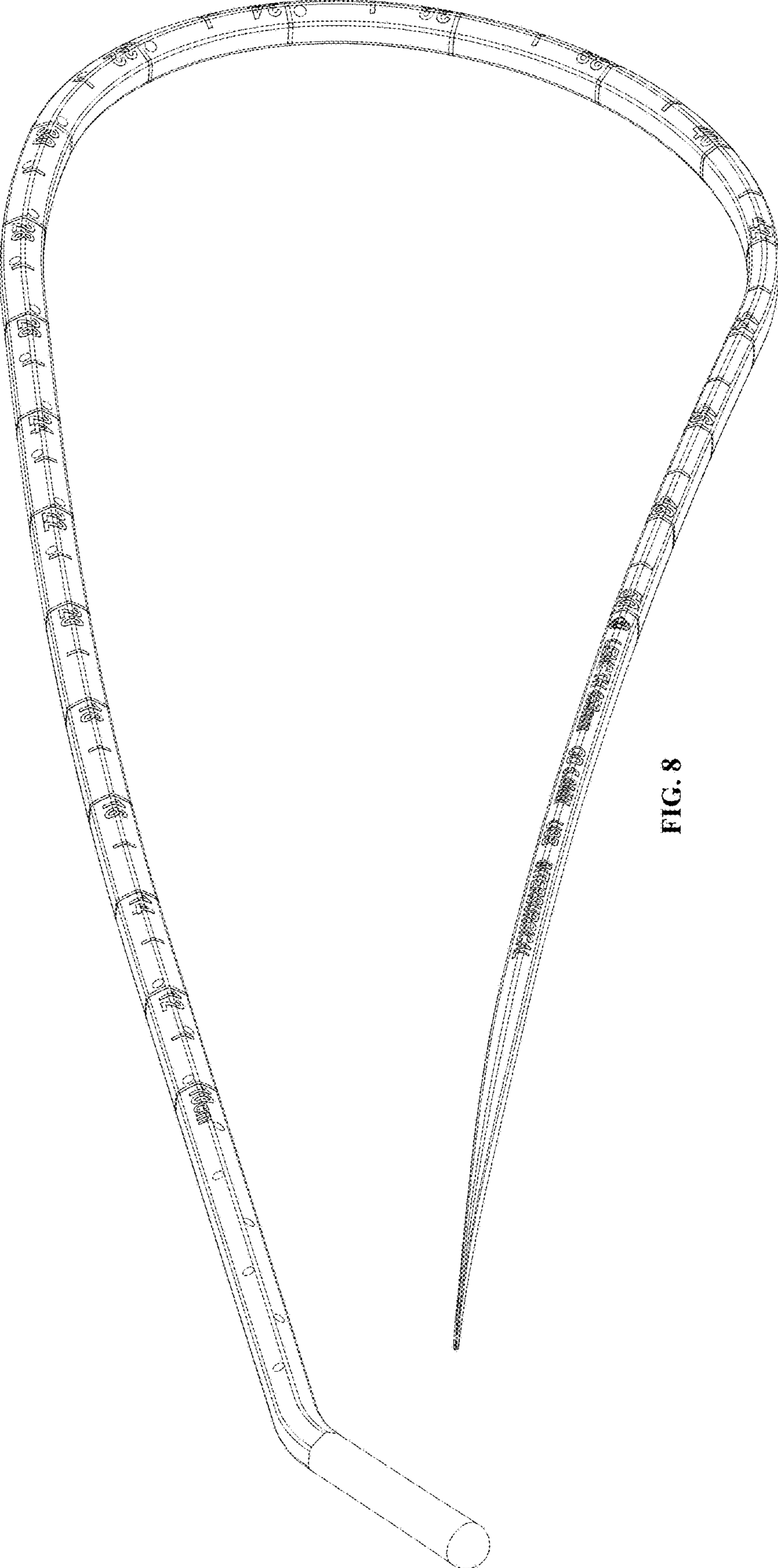

FIG. 8

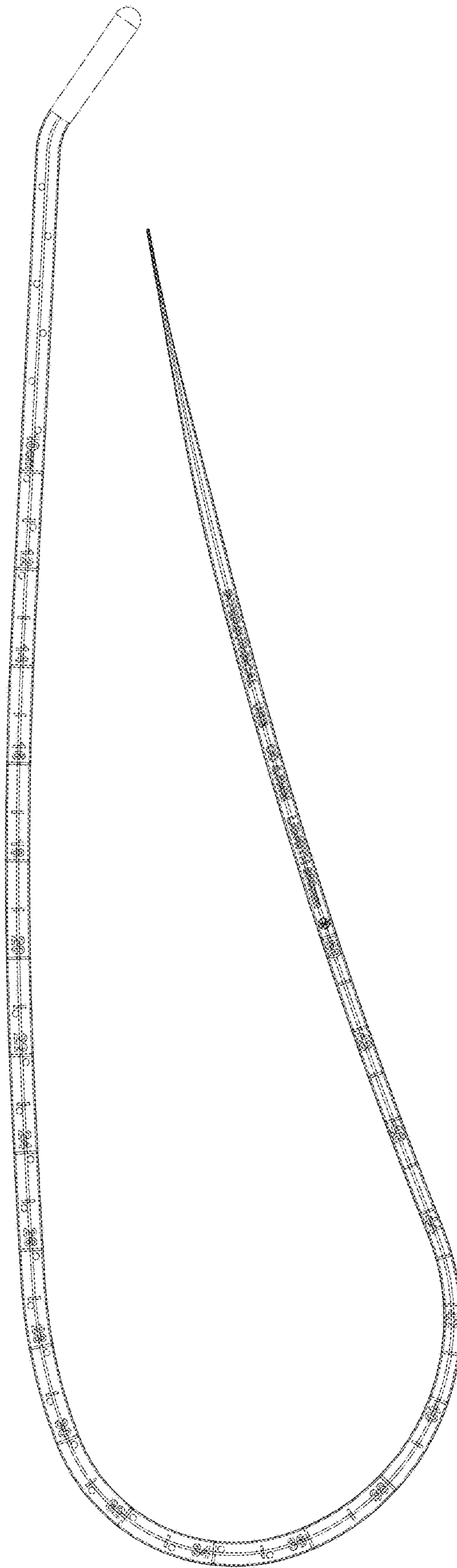

FIG. 9

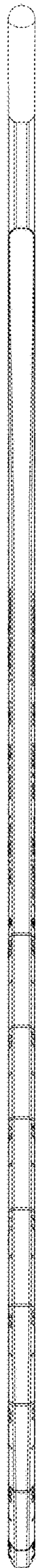

FIG. 10

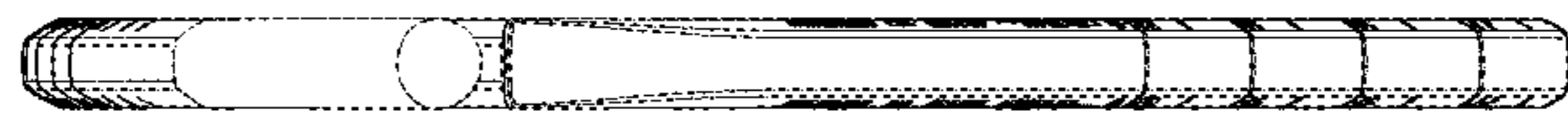

FIG. 11

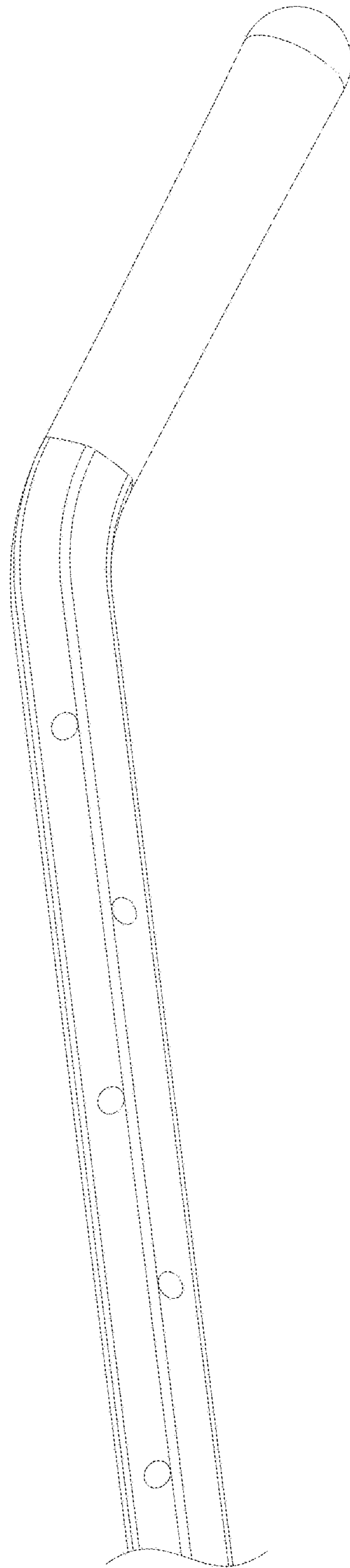

FIG. 12

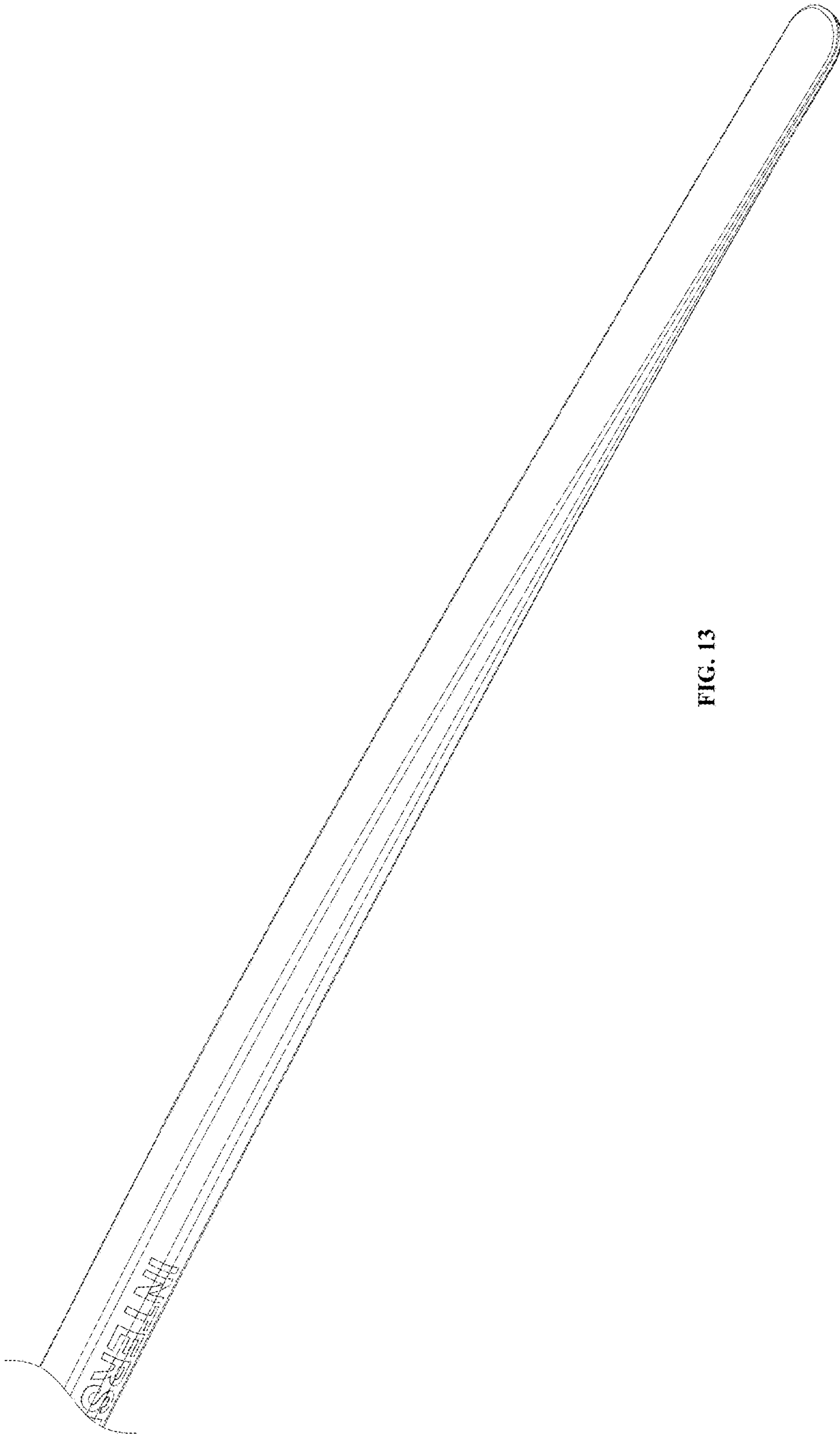

FIG. 13

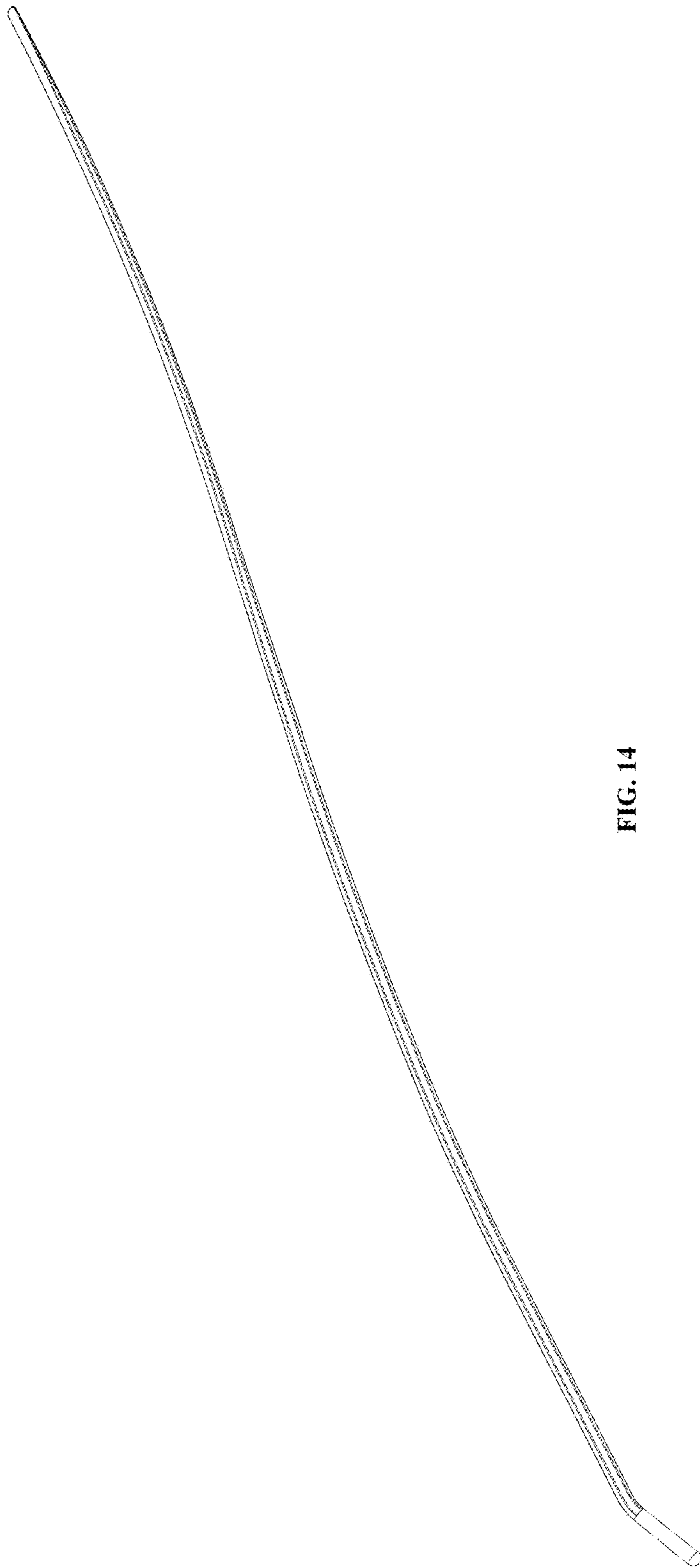

FIG. 14

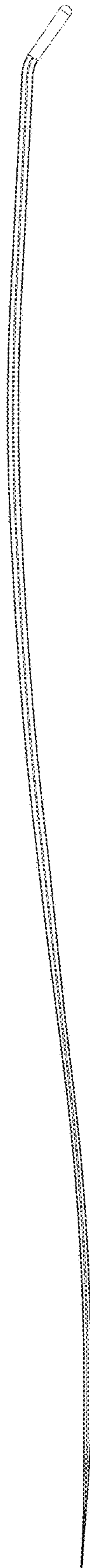

FIG. 15

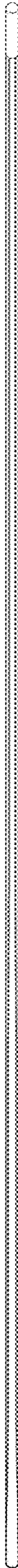

FIG. 16

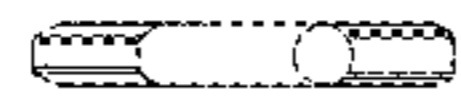

FIG. 17

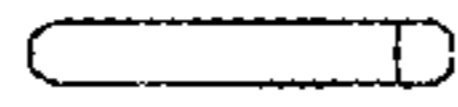

FIG. 18