



US00D808317S

(12) **United States Design Patent** (10) **Patent No.:** **US D808,317 S**
Piscitelli et al. (45) **Date of Patent:** **** Jan. 23, 2018**

(54) **VEHICLE FOG BEZEL**

(56) **References Cited**

(71) Applicants: **Chris Piscitelli**, West Bloomfield, MI (US); **Vincent J. Galante**, Lake Orion, MI (US)

U.S. PATENT DOCUMENTS

D722,282 S	*	2/2015	Loeb	D12/91
D743,850 S	*	11/2015	Howell	D12/163
D748,547 S	*	2/2016	Battams	D12/190
D748,548 S	*	2/2016	Battams	D12/190
D763,152 S	*	8/2016	Frascella	D12/190
D784,857 S	*	4/2017	Ishii	D12/91
D788,659 S	*	6/2017	Jelec	D12/163
D790,400 S	*	6/2017	Zavatski	D12/91

(72) Inventors: **Chris Piscitelli**, West Bloomfield, MI (US); **Vincent J. Galante**, Lake Orion, MI (US)

(73) Assignee: **FCA US LLC**, Auburn Hills, MI (US)

* cited by examiner

(**) Term: **15 Years**

Primary Examiner — Melody N. Brown

(21) Appl. No.: **29/594,856**

(74) *Attorney, Agent, or Firm* — Ralph E. Smith

(22) Filed: **Feb. 23, 2017**

(57) **CLAIM**

The ornamental design for a vehicle fog bezel, as shown and described.

Related U.S. Application Data

DESCRIPTION

(63) Continuation-in-part of application No. 29/568,731, filed on Jun. 21, 2016.

(51) **LOC (11) Cl.** **12-16**

(52) **U.S. Cl.**
USPC **D12/190; D12/163**

(58) **Field of Classification Search**
USPC D12/163, 190, 196, 86, 90-92, 171, 169,
D12/216, 98; 180/68.1, 68.6;
293/193.11
CPC B62D 25/08; B62B 9/16; B60K 11/08;
B60R 19/52; B60J 10/35; B60J 10/0011;
B60J 10/02

FIG. 1 is a front perspective view of a vehicle fog bezel showing our new design;
FIG. 2 is a side view thereof;
FIG. 3 is an opposite side view thereof;
FIG. 4 is a front view thereof;
FIG. 5 is a rear view thereof;
FIG. 6 is a top view thereof; and,
FIG. 7 is a bottom view thereof.

It will be understood that the broken lines shown in the drawings illustrate portions of the vehicle fog bezel that form no part of claimed design.

See application file for complete search history.

1 Claim, 5 Drawing Sheets

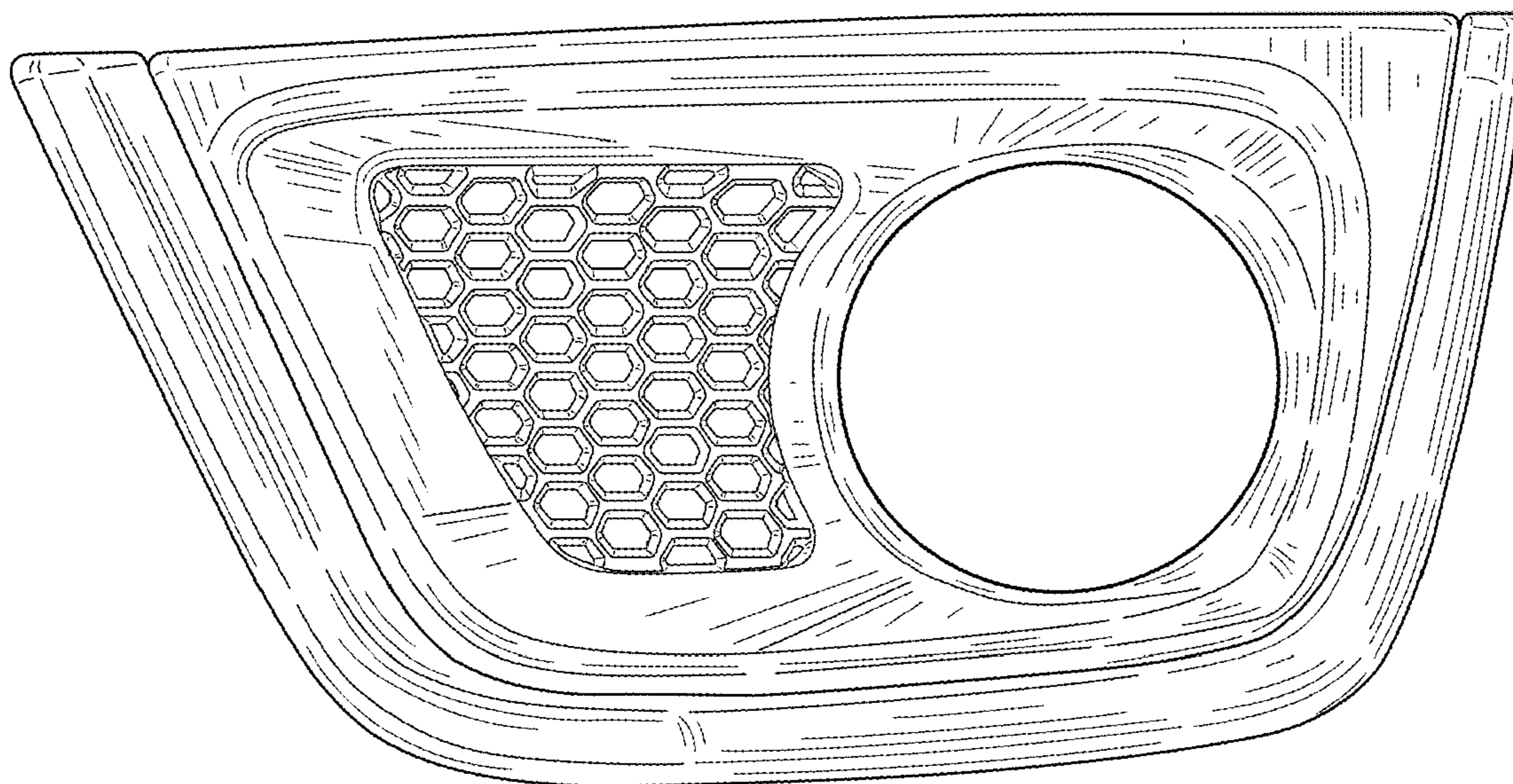

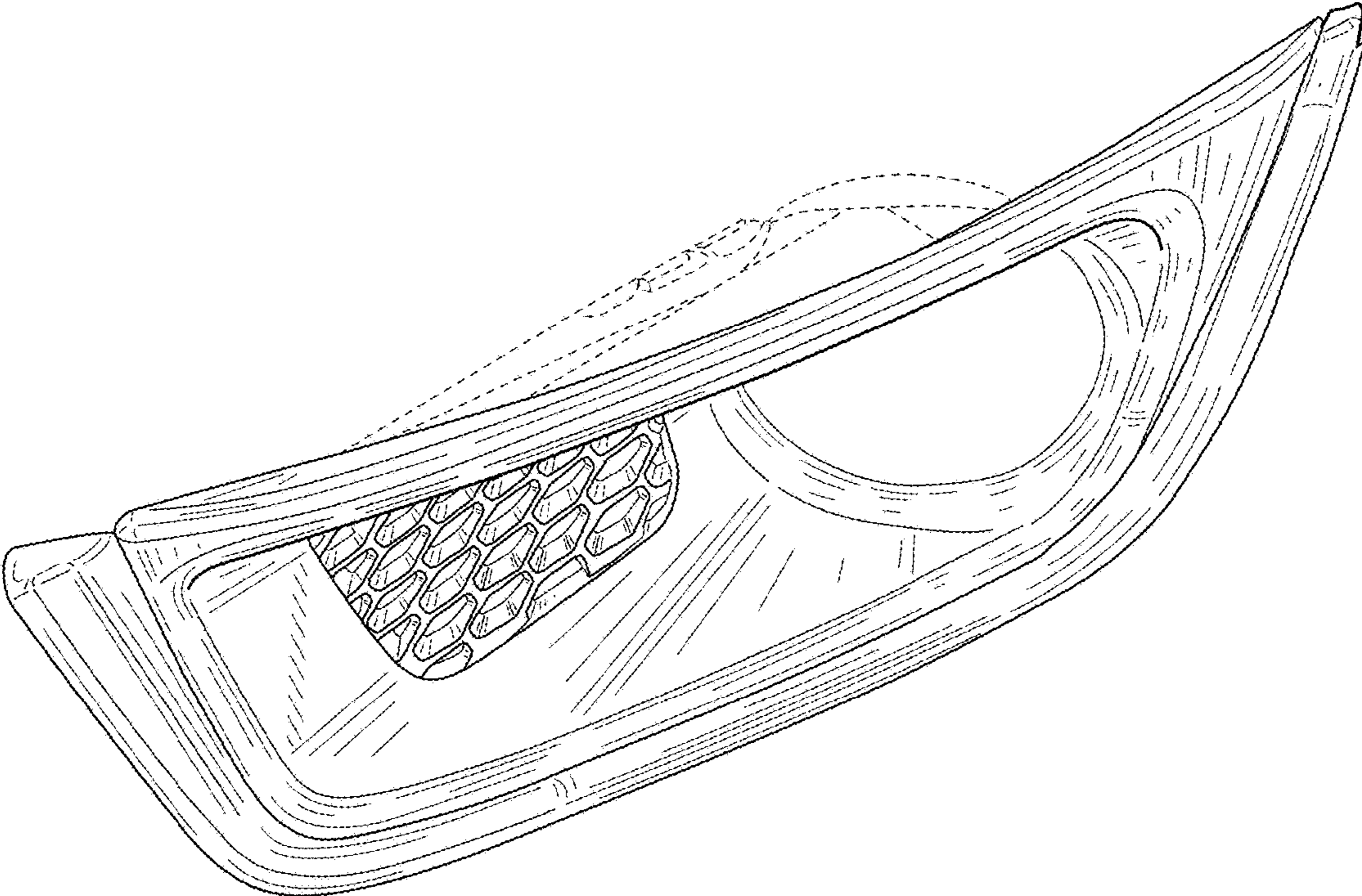

FIG. 1

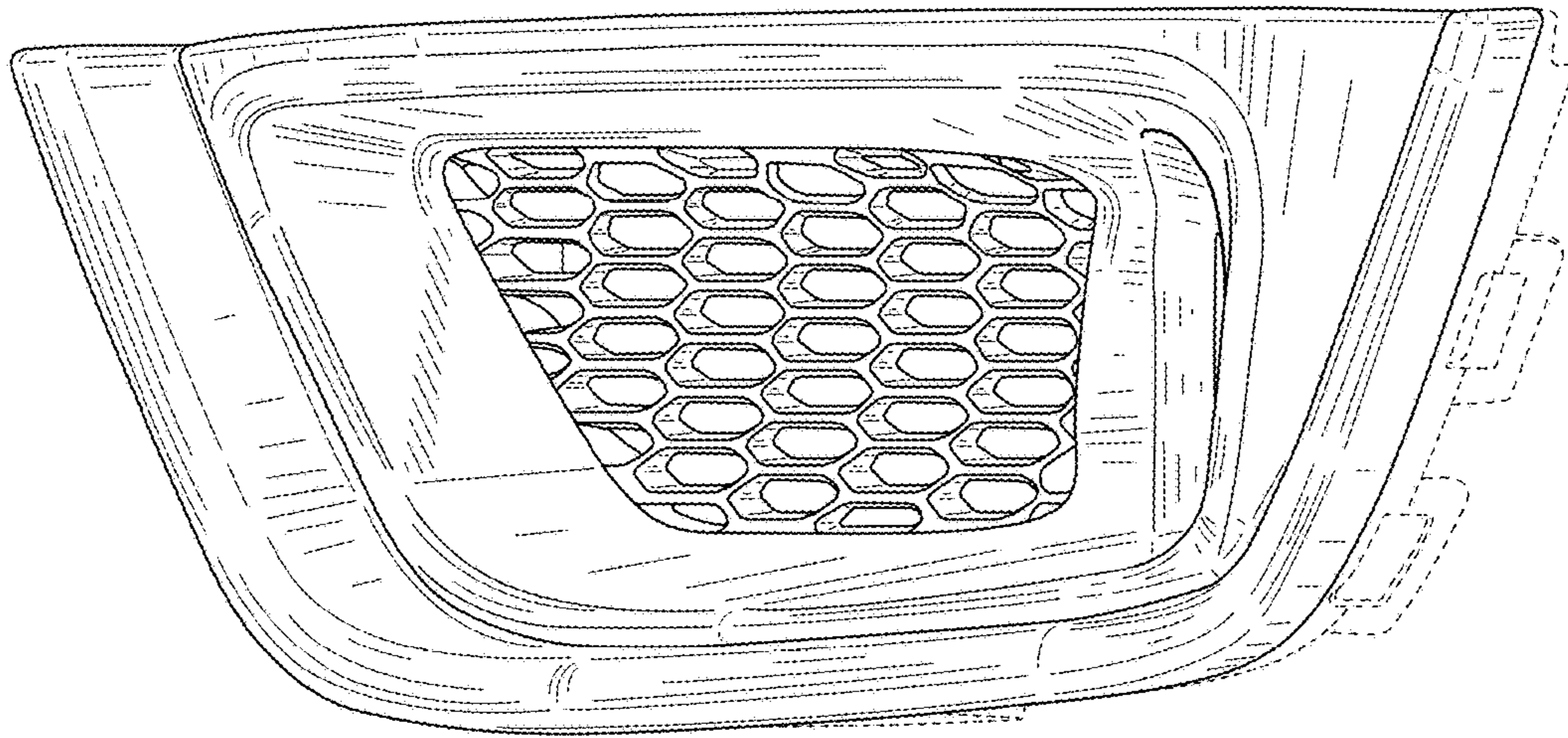

FIG. 2

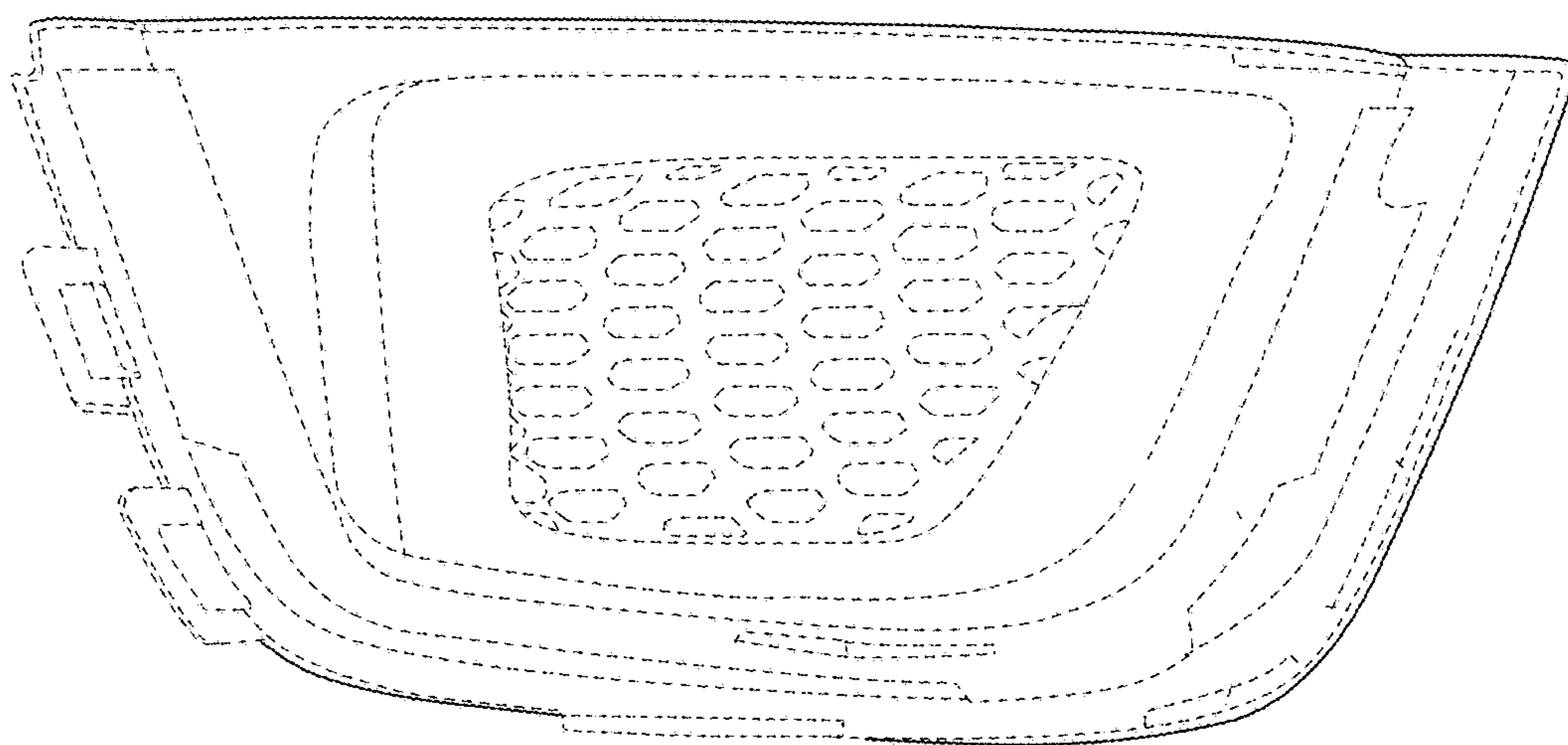

FIG. 3

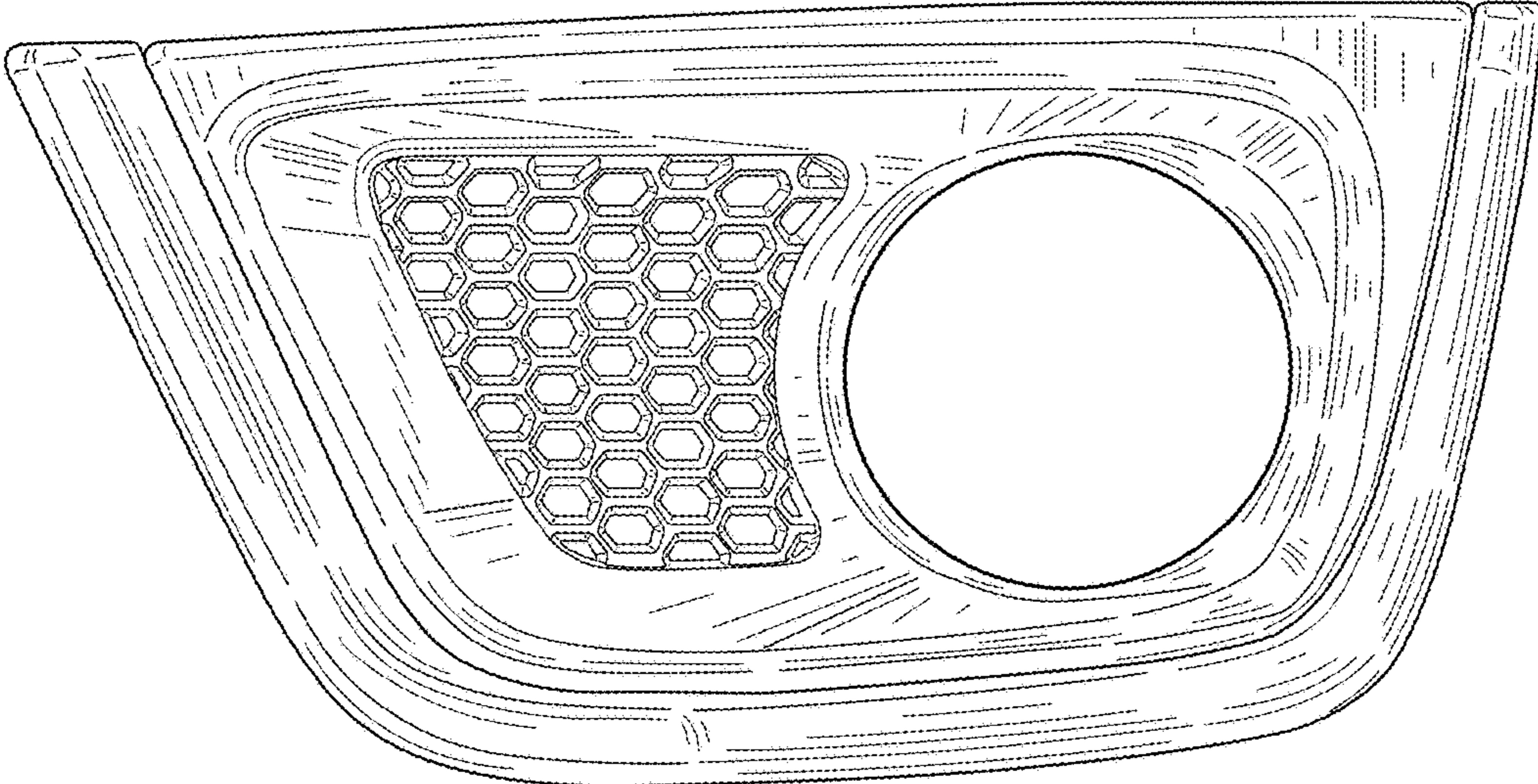

FIG. 4

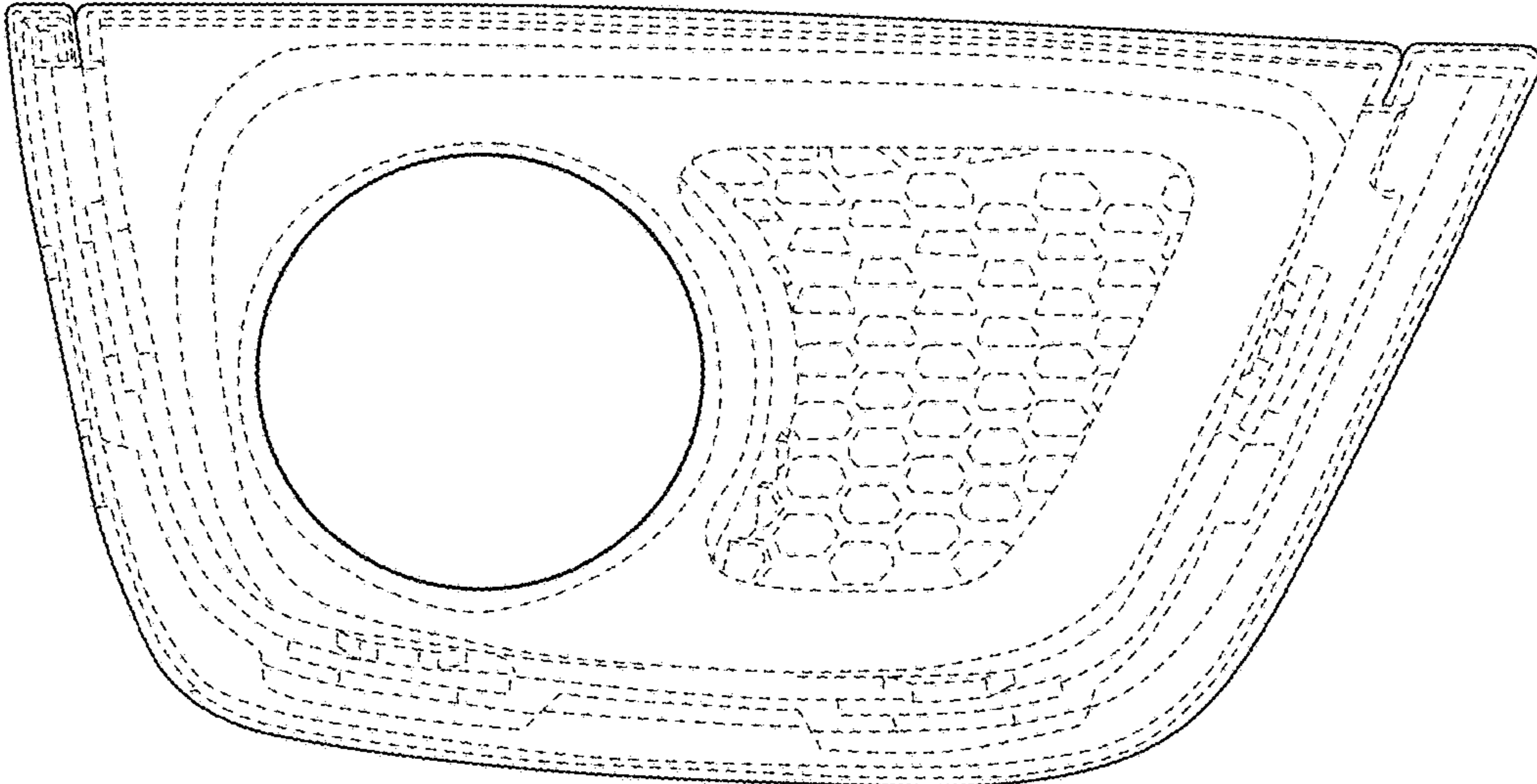

FIG. 5

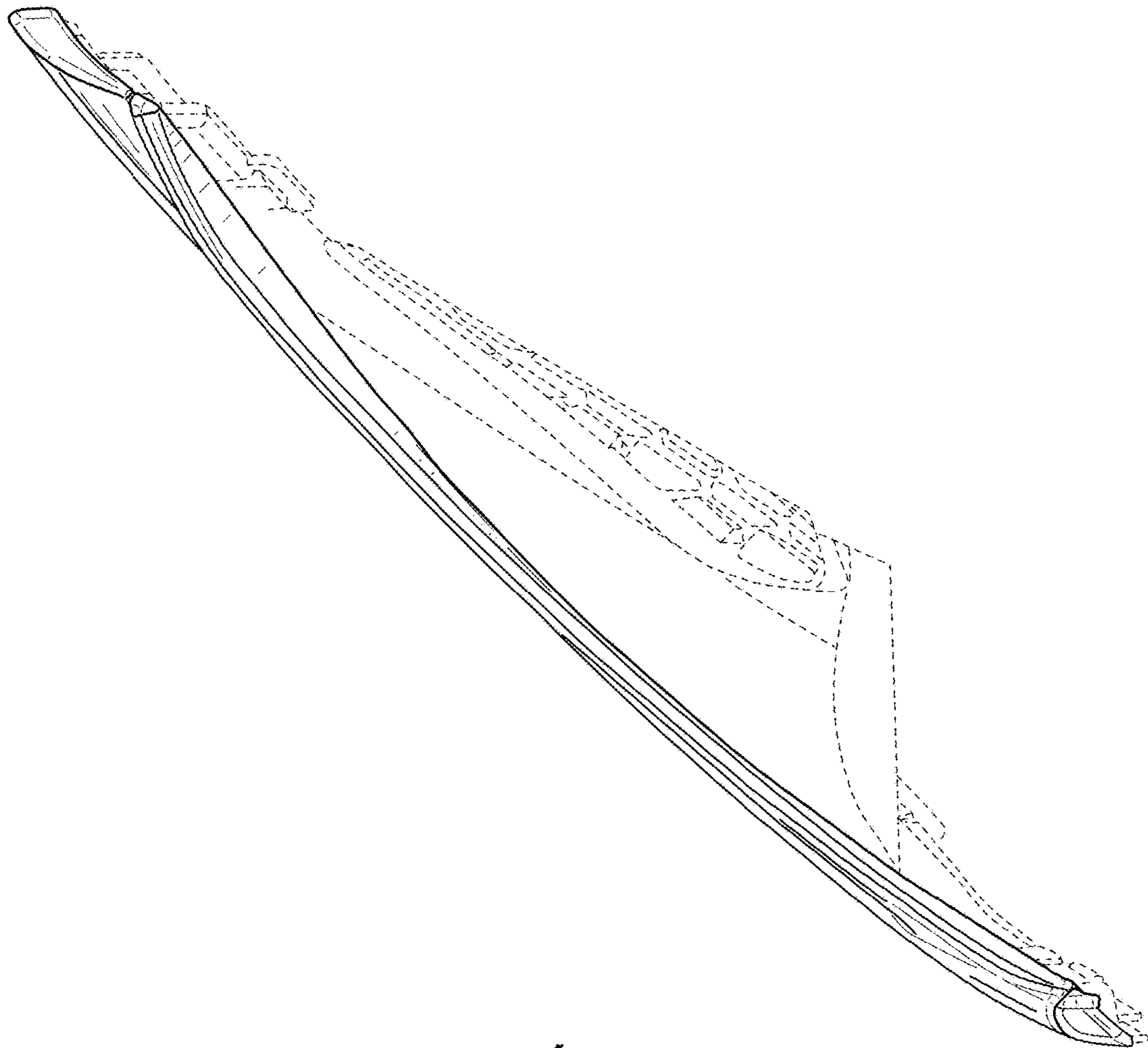

FIG. 6

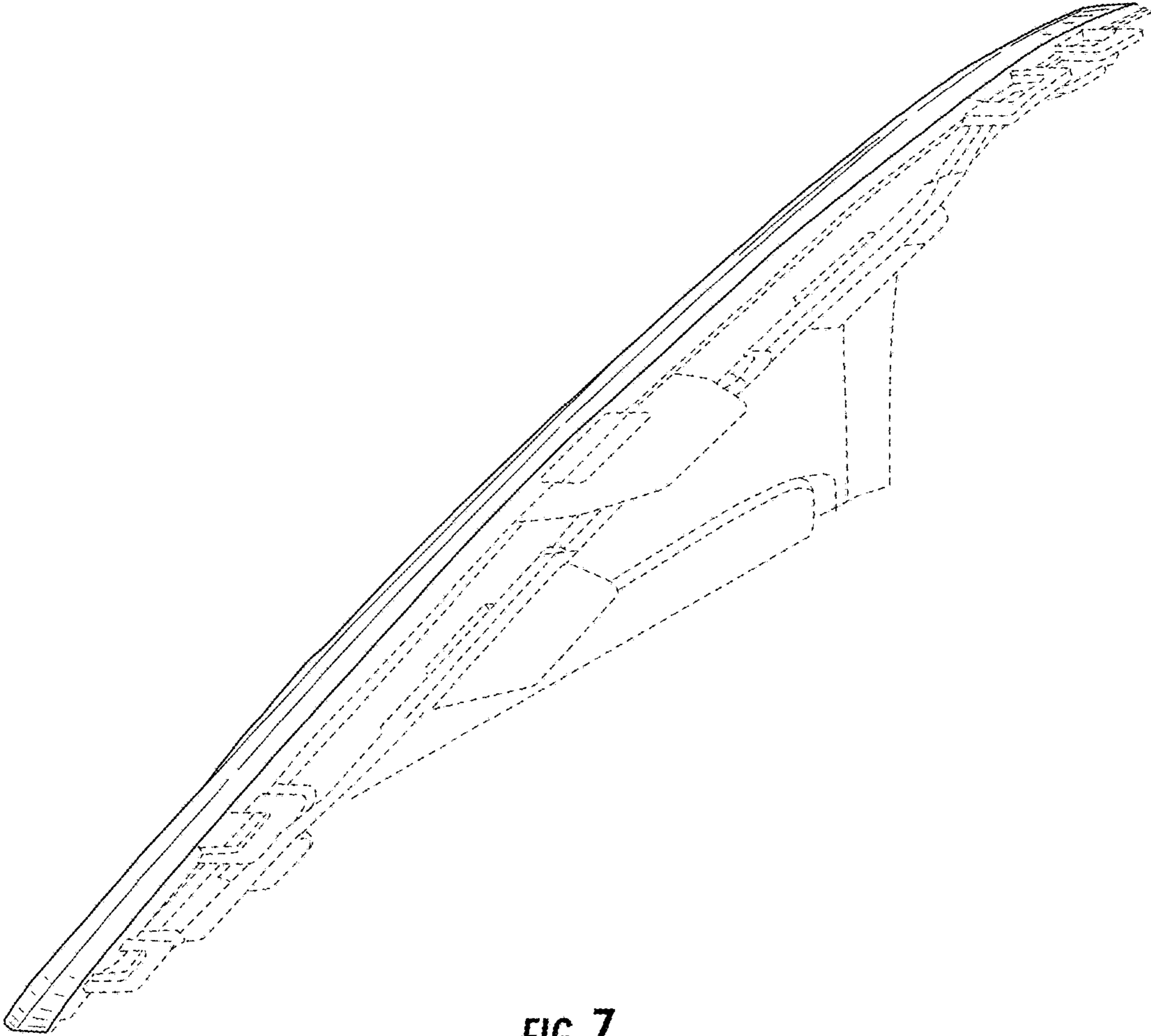

FIG. 7