



US00D808239S

(12) **United States Design Patent**
Bloch

(10) **Patent No.:** **US D808,239 S**

(45) **Date of Patent:** **** Jan. 23, 2018**

(54) **KNIFE AND ASSOCIATED SHEATH**

(71) Applicant: **Outdoor Edge Cutlery Corporation,**
Denver, CO (US)

(72) Inventor: **David R. Bloch,** Morrison, CO (US)

(73) Assignee: **OUTDOOR EDGE CUTLERY**
CORPORATION, Denver, CO (US)

(**) Term: **15 Years**

(21) Appl. No.: **29/590,130**

(22) Filed: **Jan. 6, 2017**

(51) **LOC (11) Cl.** **08-03**

(52) **U.S. Cl.**
USPC **D8/98; D22/118**

(58) **Field of Classification Search**
USPC D8/14, 98, 99, 100, 105, 107; D22/118;
D11/214, 215, 216

(Continued)

(56) **References Cited**

U.S. PATENT DOCUMENTS

D300,112 S * 3/1989 Osterhout D8/107
4,998,550 A * 3/1991 Archambault A47L 15/4257
134/200

(Continued)

OTHER PUBLICATIONS

“5 in 1 Outdoor Survival Gear Escape Paracord Bracelet Flint/Whistle/Compass/Scraper,” believed to be on sale at least by Aug. 17, 2016, retrieved from https://www.boardwalkbuy.com/products/5-in-1-outdoor-survival-gear-escape-paracord-bracelet-flint-whistle-compass-scraper?utm_medium=cpc&utm_source=googlepla&gclid=CjwKEAajwItC9BRDRvMfD2N66nIISJACq8591rKgFVKcoy8Fg9KD9-v2gMf9_vb1Aw8oOEvLi6Bt1uRoClwPw_wcB, 4 pages.

(Continued)

Primary Examiner — Philip S Hyder

(74) *Attorney, Agent, or Firm* — Lewis Brisbois Bisgaard & Smith LLP; Craig W. Mueller

(57) **CLAIM**

The ornamental design for a knife and associated sheath, as shown and described.

DESCRIPTION

FIG. 1 is a perspective view of the knife and associated sheath shown in a first position of use, wherein a portion of the knife is located within the sheath;

FIG. 2 is a front elevation view thereof;

FIG. 3 is a rear elevation view thereof;

FIG. 4 is a left elevation view thereof;

FIG. 5 is a right elevation view thereof;

FIG. 6 is a top plan view thereof;

FIG. 7 is a bottom plan view thereof;

FIG. 8 is a perspective view of the knife and associated sheath shown in a second position of use, wherein the knife is spaced from the sheath;

FIG. 9 is a front elevation thereof;

FIG. 10 is a rear elevation view thereof;

FIG. 11 is a left elevation view thereof;

FIG. 12 is a right elevation view thereof;

FIG. 13 is a top plan view thereof;

FIG. 14 is a bottom plan view thereof;

FIG. 15 is a perspective view of the knife and associated sheath interconnected to a bracelet shown in a first position of use, wherein a portion of the knife is located within the sheath;

FIG. 16 is a front elevation view thereof;

FIG. 17 is a rear elevation view thereof;

FIG. 18 is a left elevation view thereof;

FIG. 19 is a right elevation view thereof;

FIG. 20 is a top plan view thereof;

FIG. 21 is a bottom plan view thereof;

FIG. 22 is a perspective view of the knife and associated sheath interconnected to a bracelet shown in a second position of use, wherein the knife is spaced from the sheath;

FIG. 23 is a front elevation view thereof;

FIG. 24 is a rear elevation view thereof;

FIG. 25 is a left elevation view thereof;

FIG. 26 is a right elevation view thereof;

(Continued)

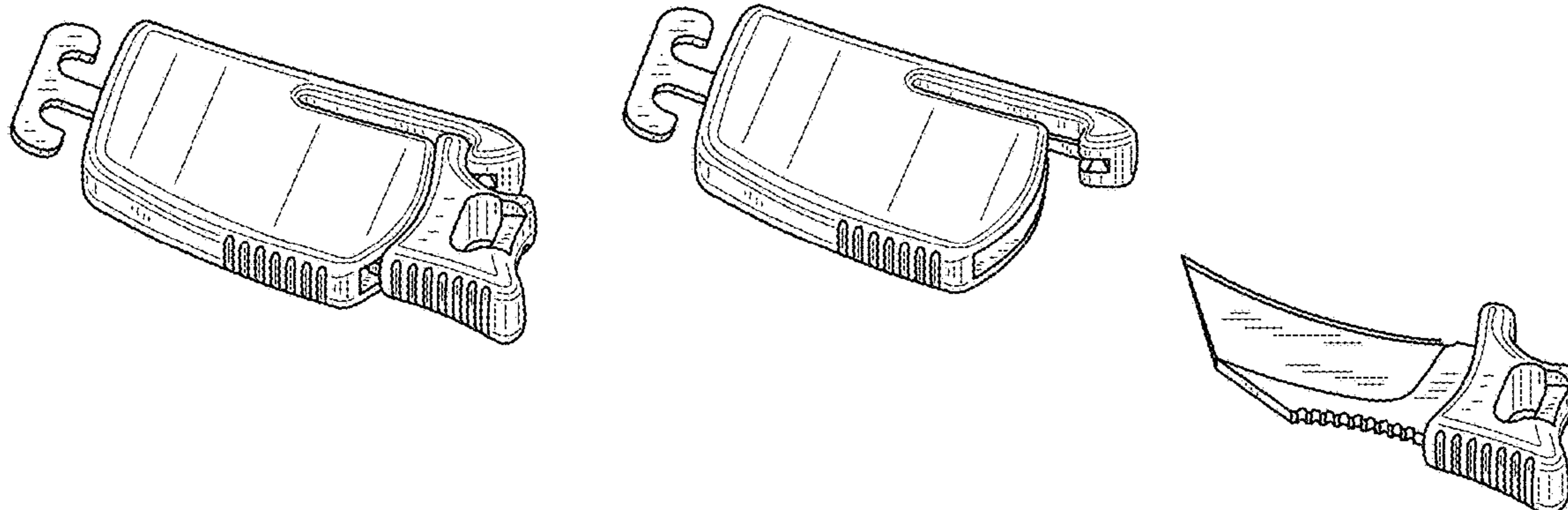

FIG. 27 is top plan view thereof; and, FIG. 28 is a bottom plan view thereof. The broken lines depict environment and form no part of the claimed invention.

1 Claim, 15 Drawing Sheets

(58) Field of Classification Search

CPC .. B26B 3/00; B26B 3/06; B26B 29/00; B26B 29/02; B26B 11/00

See application file for complete search history.

(56) References Cited

U.S. PATENT DOCUMENTS

D321,548 S * 11/1991 Collins D22/118

5,092,046 A * 3/1992 Collins B26B 29/025
224/232
5,511,311 A * 4/1996 Collins B26B 1/08
224/232
5,915,793 A * 6/1999 Serpa B26B 29/025
224/232
6,442,843 B1 * 9/2002 Jue B26B 3/06
224/232
D465,542 S * 11/2002 Bloch D22/118
D723,132 S * 2/2015 Borland D22/118
D770,327 S * 11/2016 Chan D11/216

OTHER PUBLICATIONS

“Hidetoshi Nakayama Knife Archives,” believed to be on sale at least by Aug. 17, 2016, retrieved from <http://www.artknives.com/hidetoshi-nakayama-archives.html>, 6 pages.

* cited by examiner

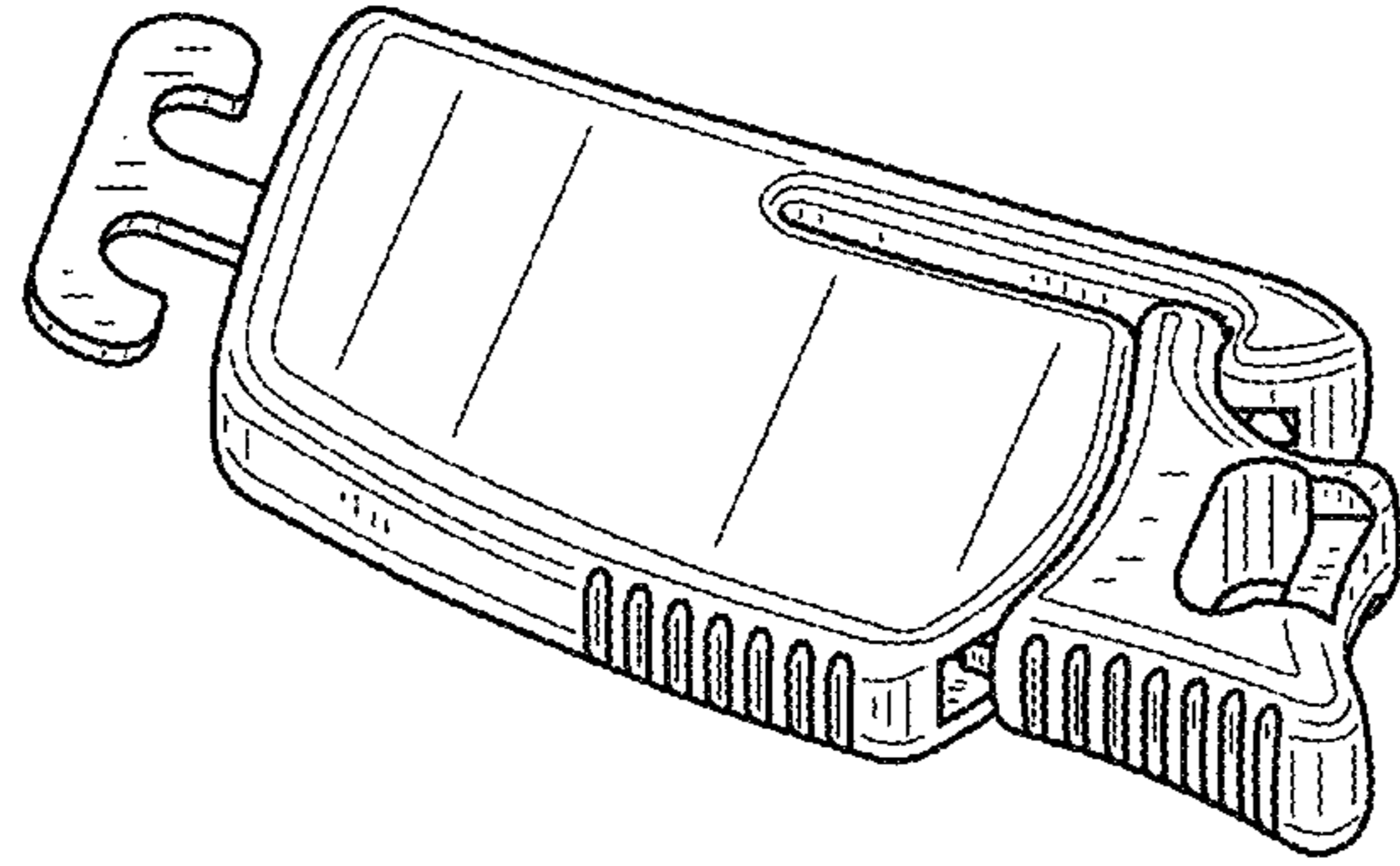

FIG.1

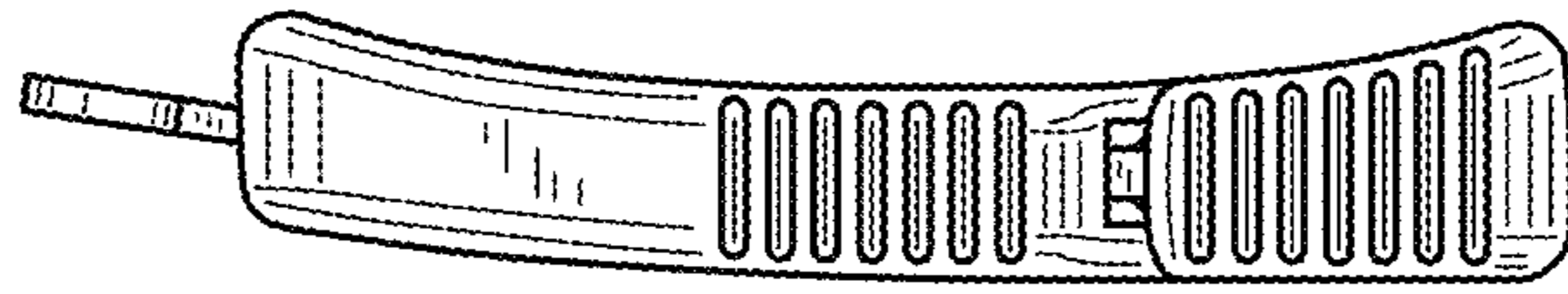

FIG.2

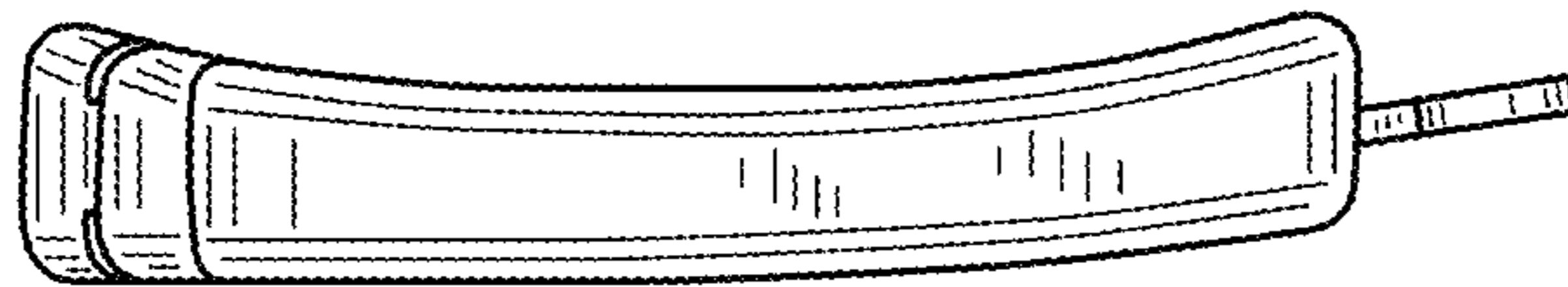

FIG.3

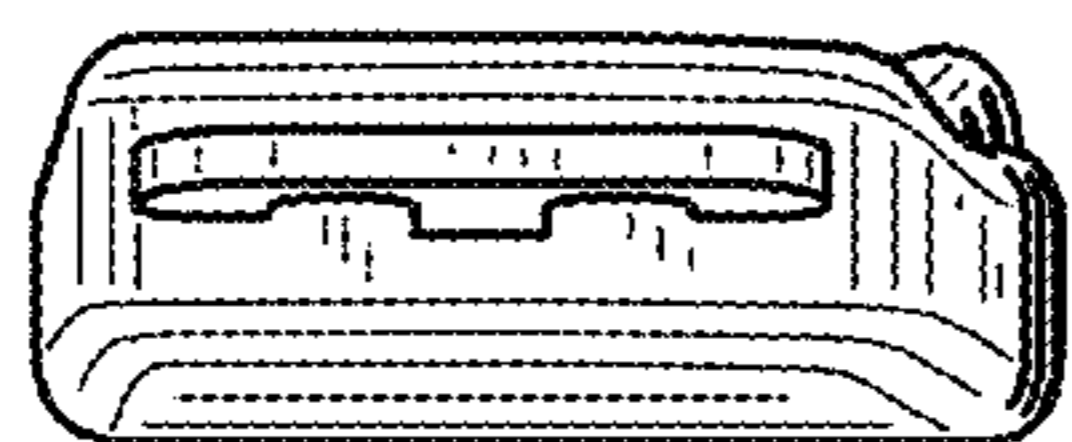

FIG. 4

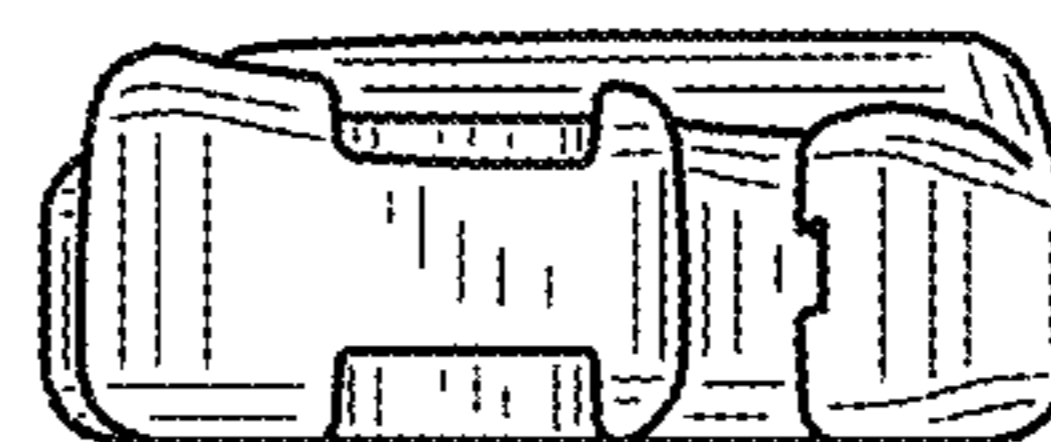

FIG. 5

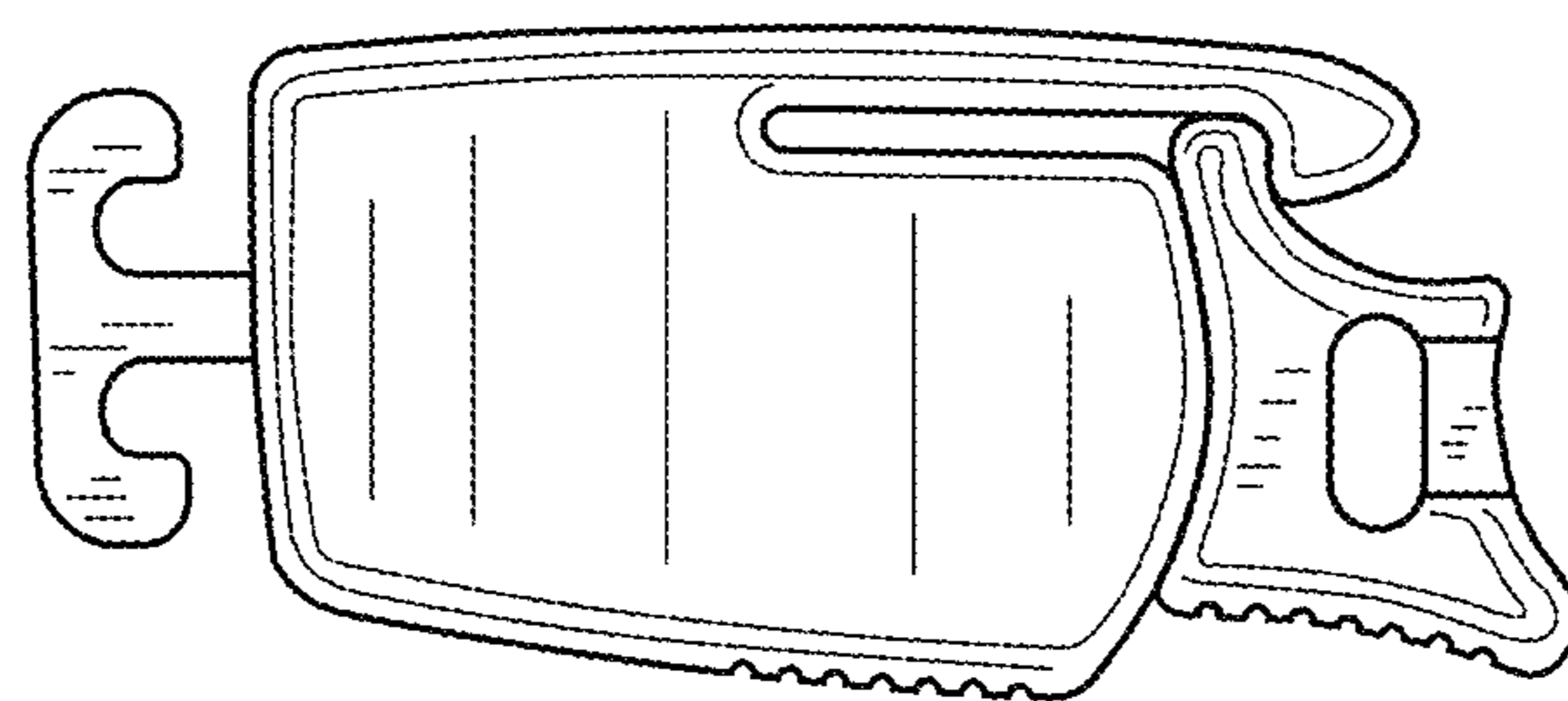

FIG. 6

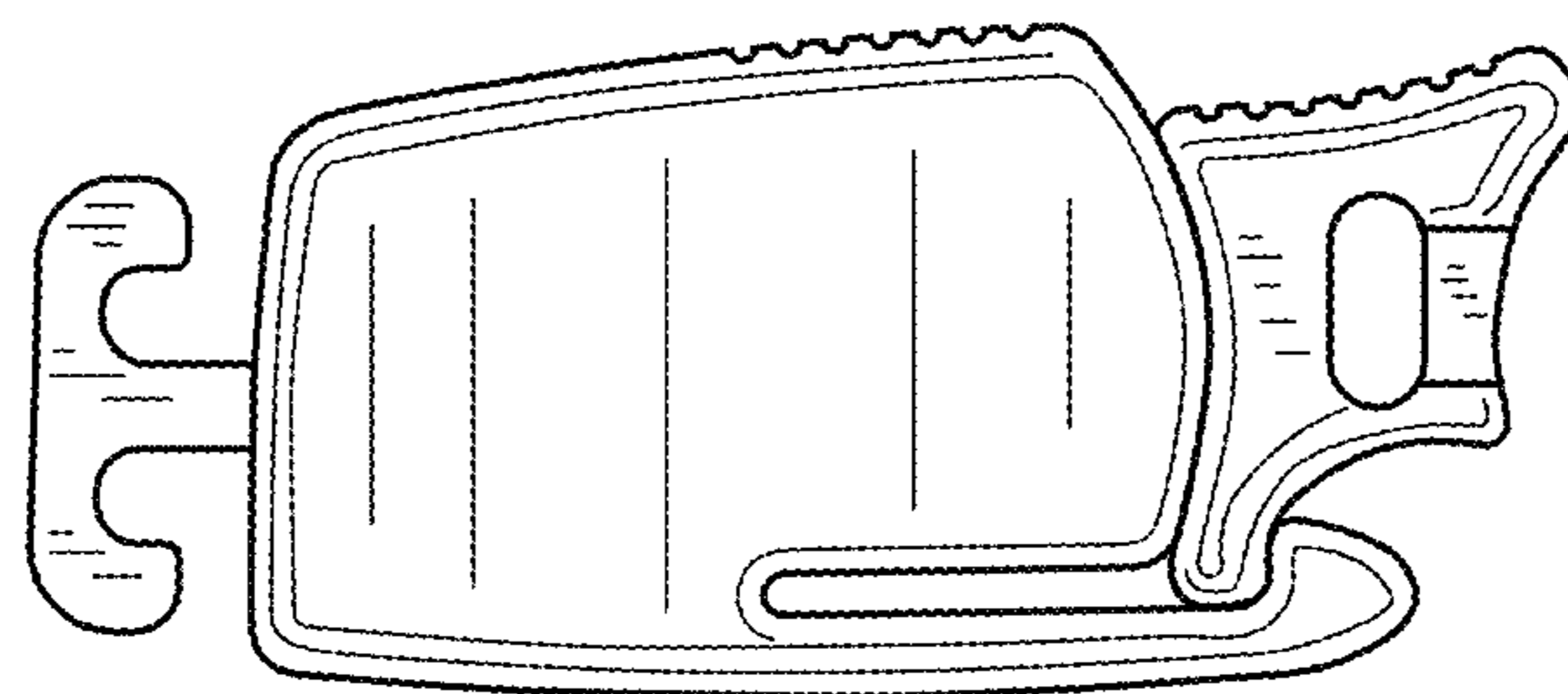

FIG. 7

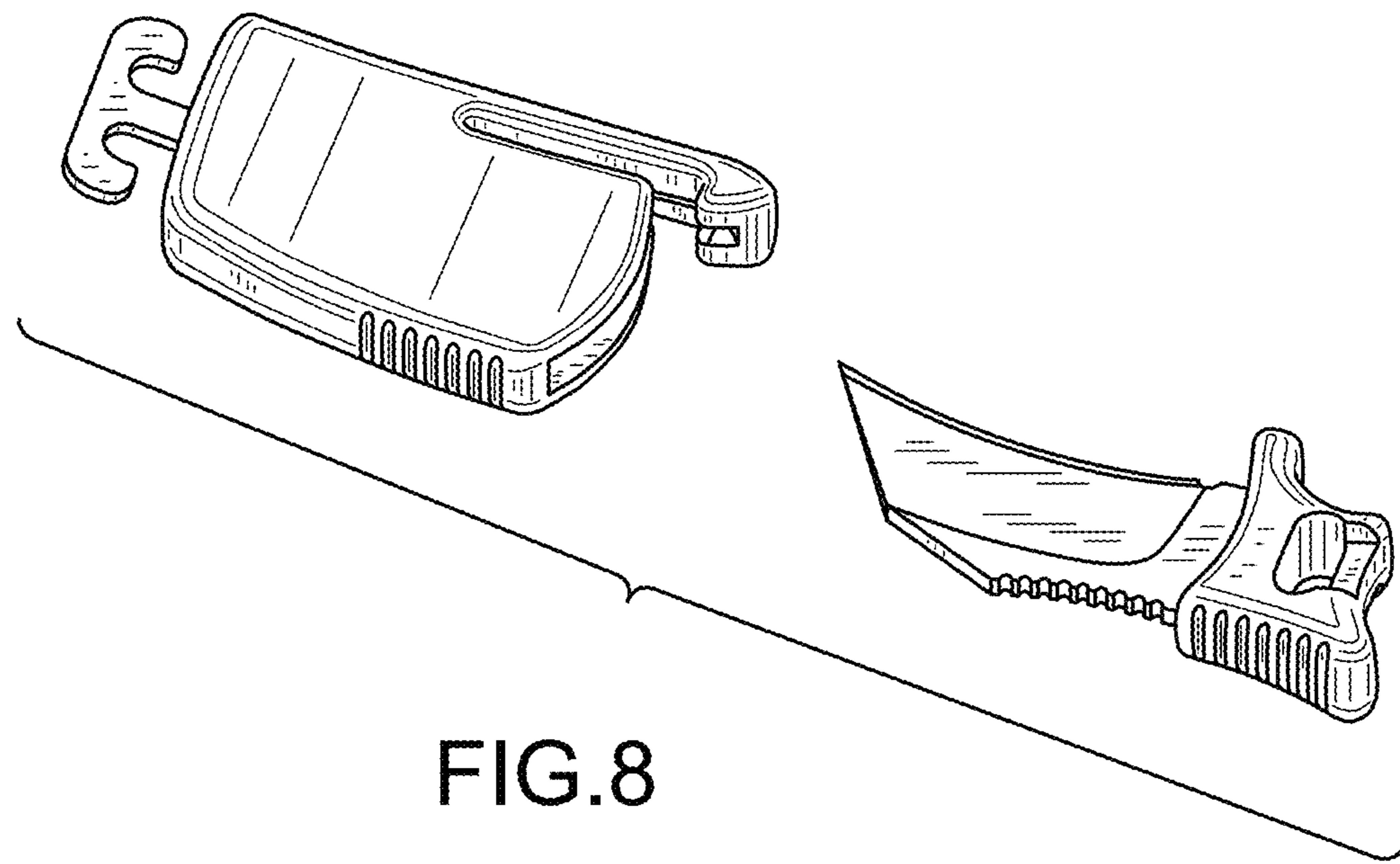

FIG. 8

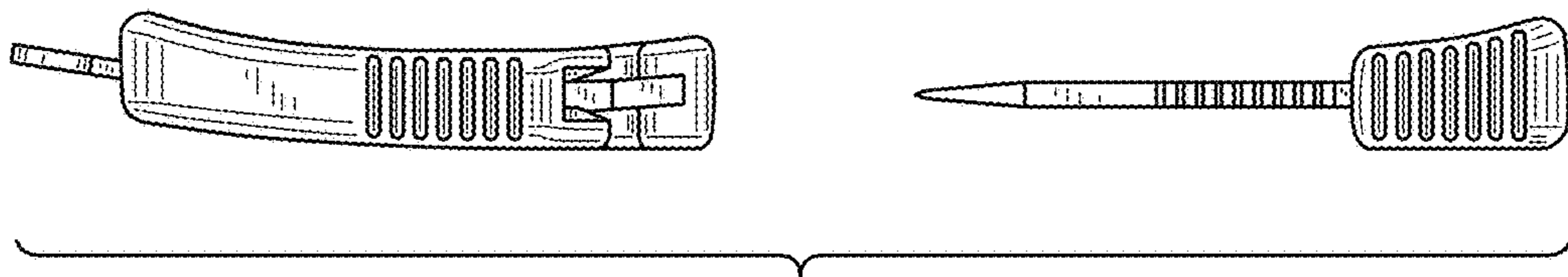

FIG.9

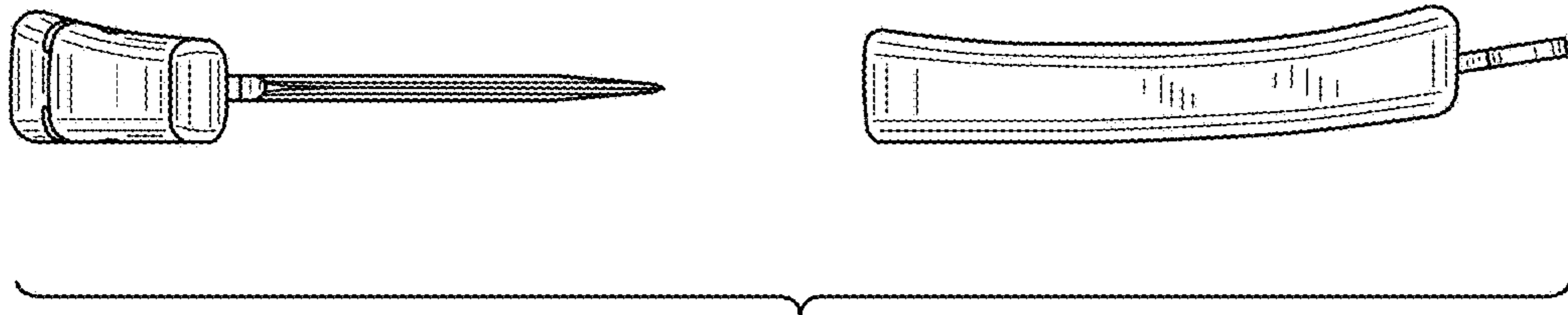

FIG.10



FIG. 11

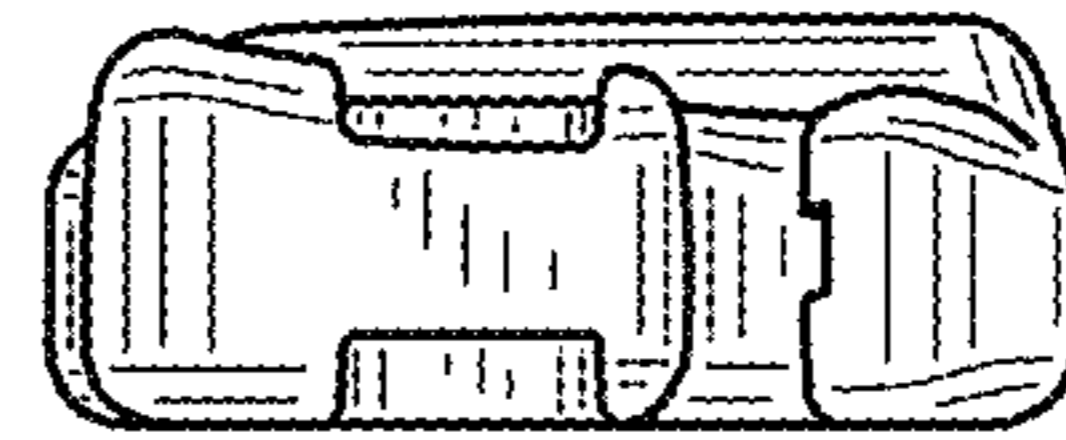

FIG. 12

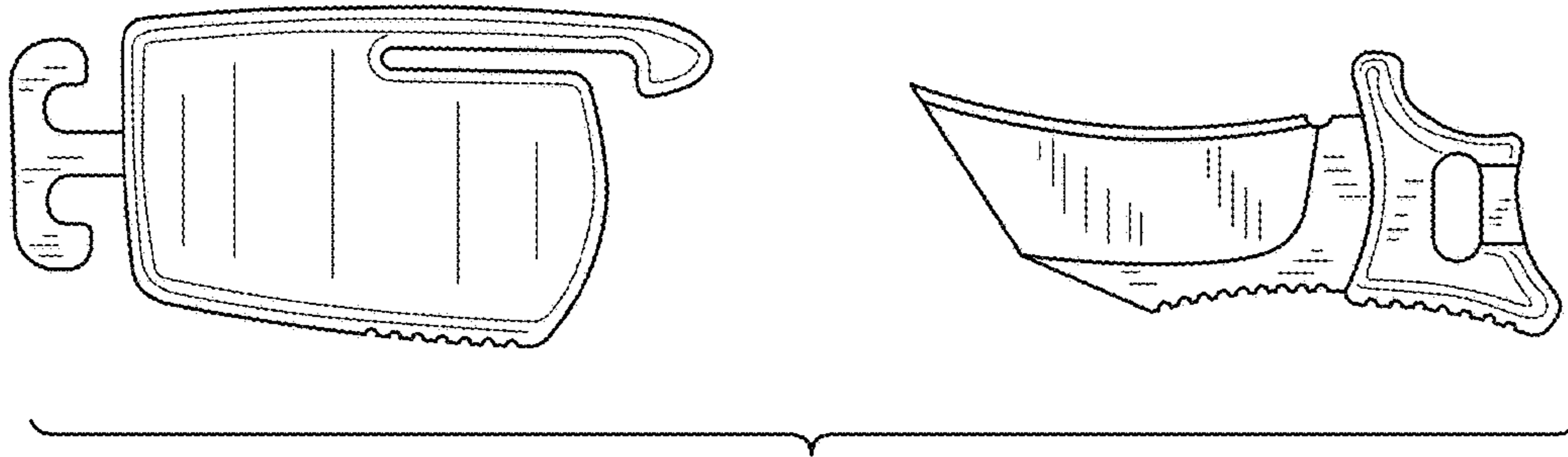

FIG.13

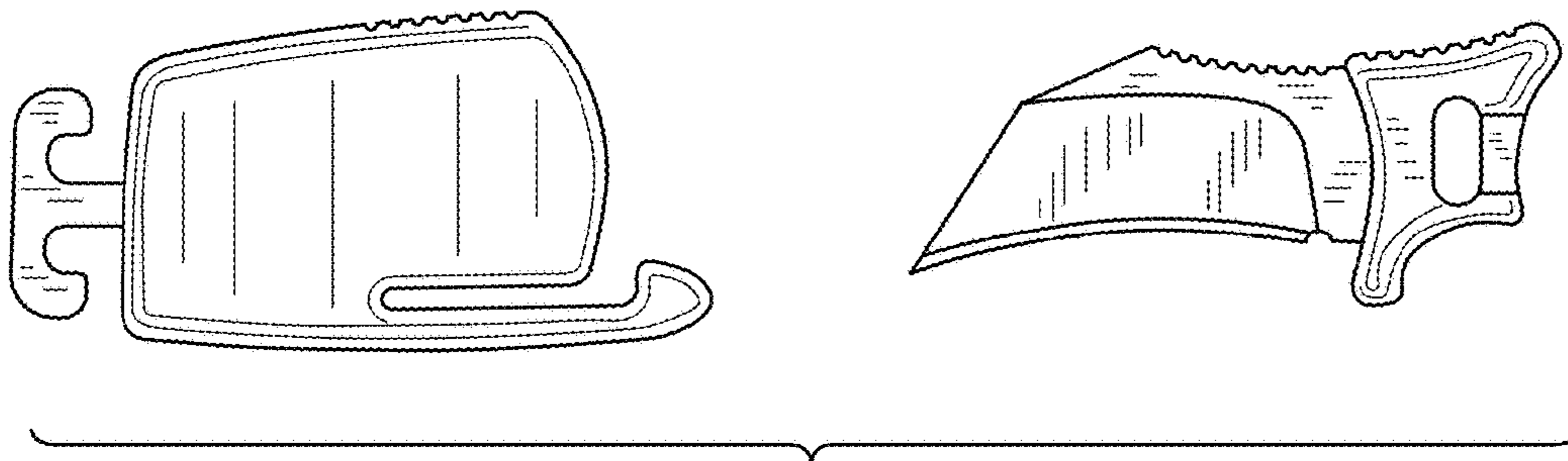

FIG.14

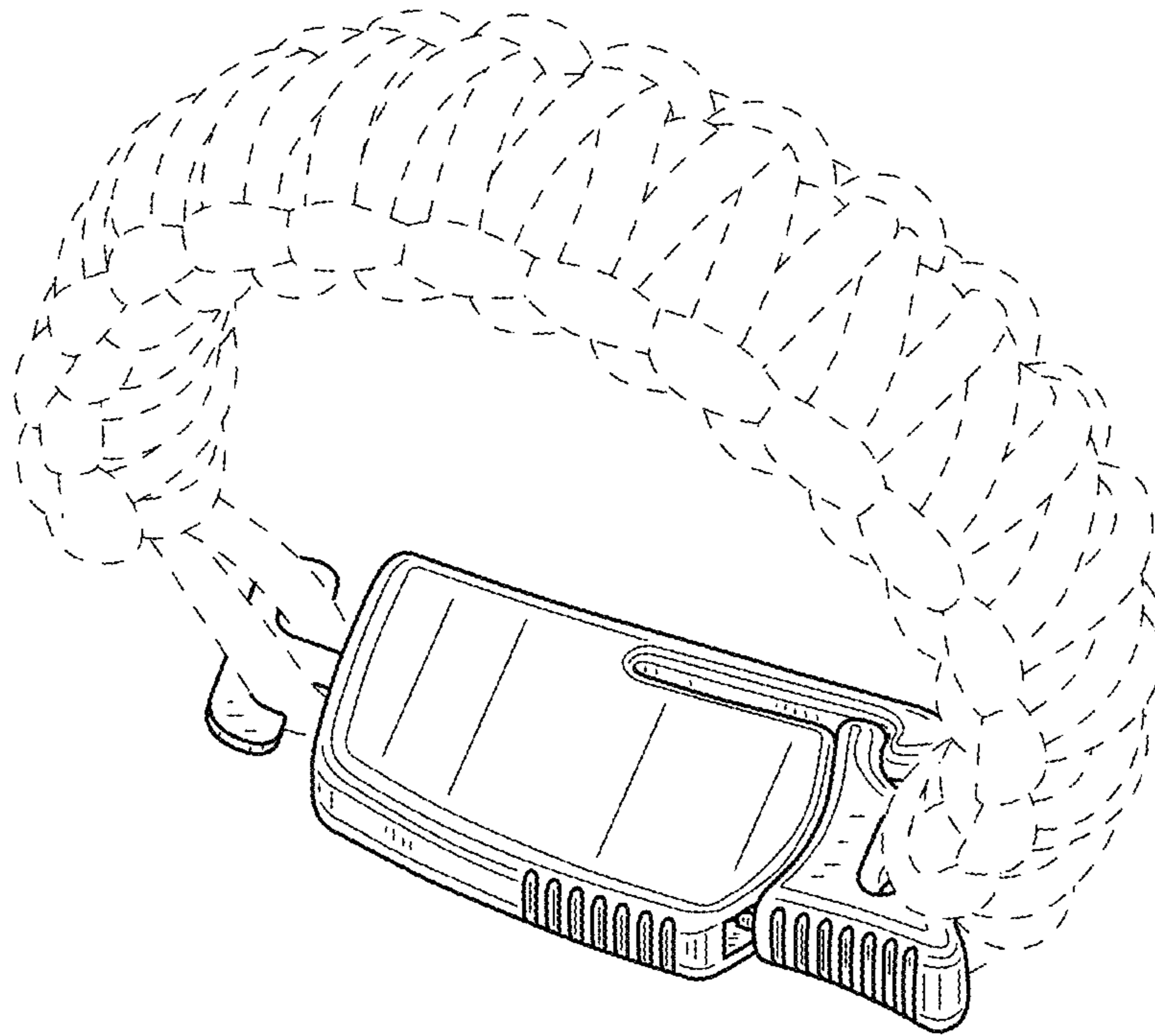

FIG.15

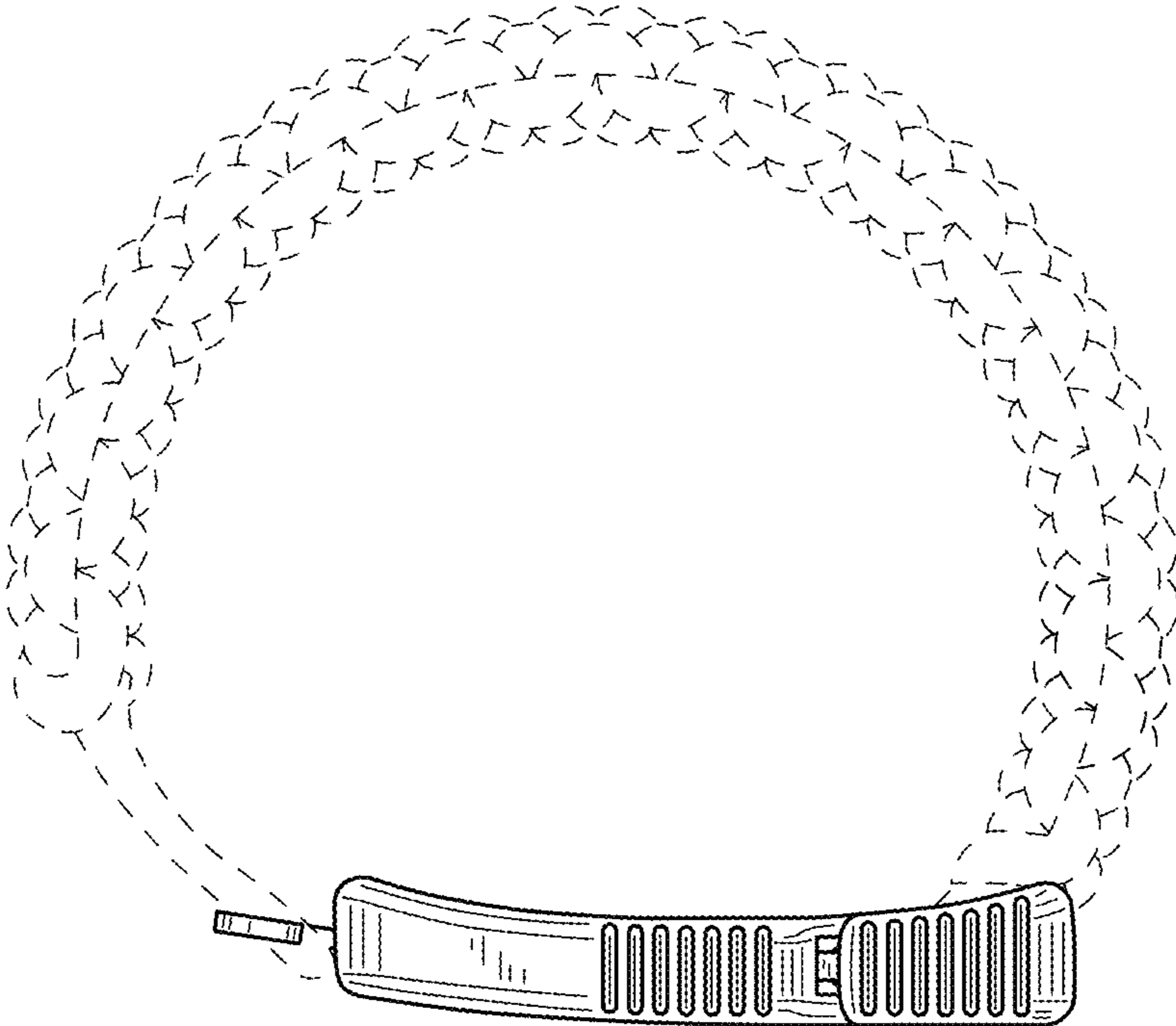

FIG.16

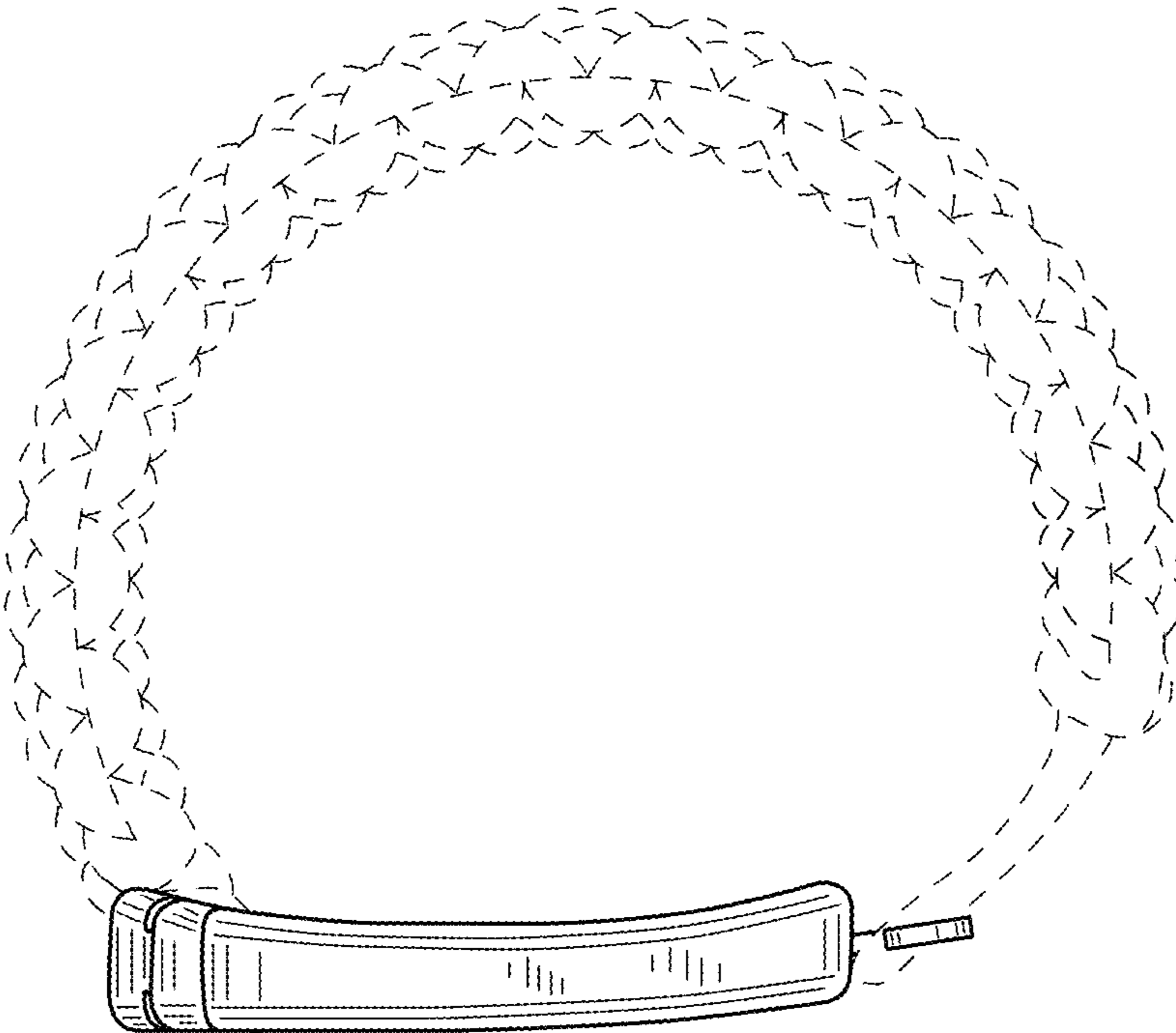

FIG.17

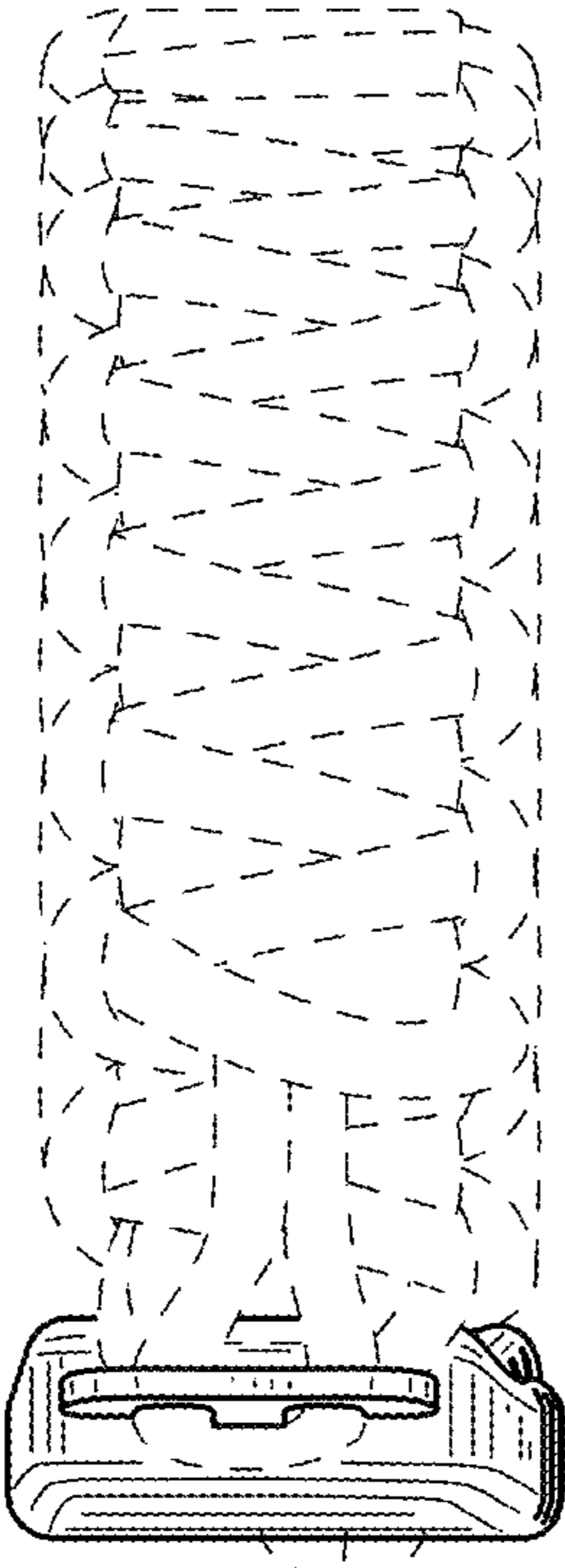

FIG. 18

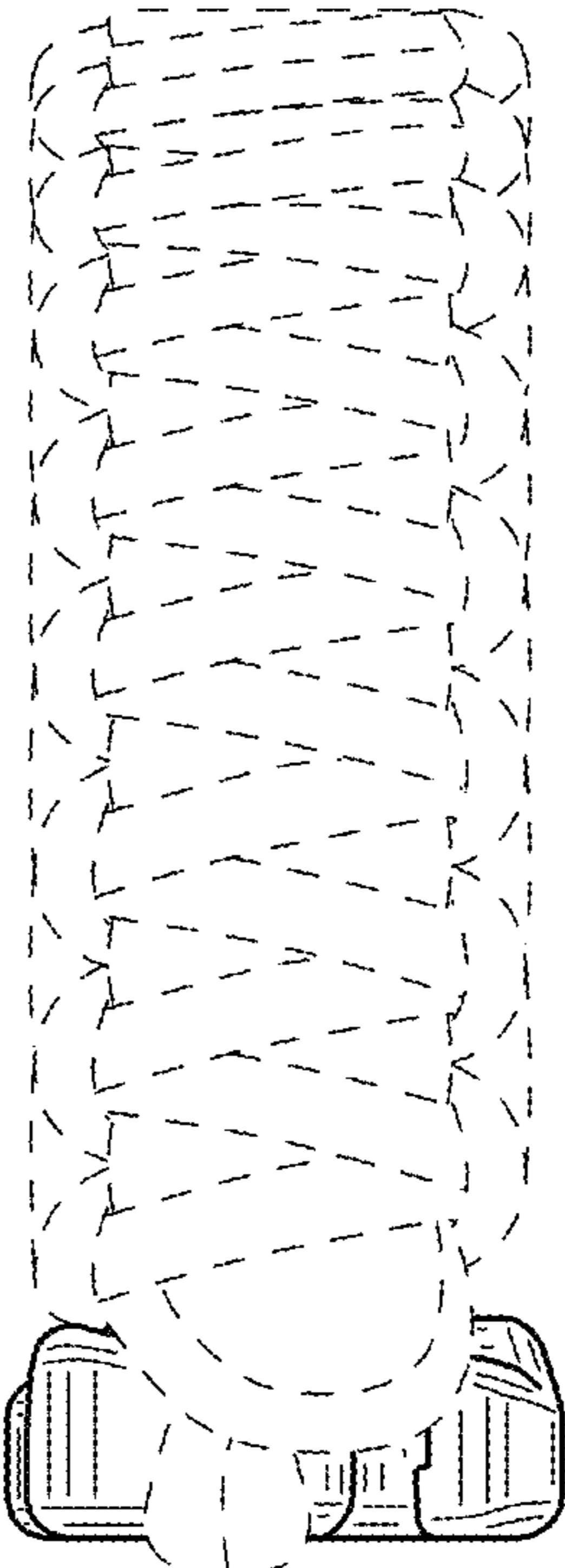

FIG. 19

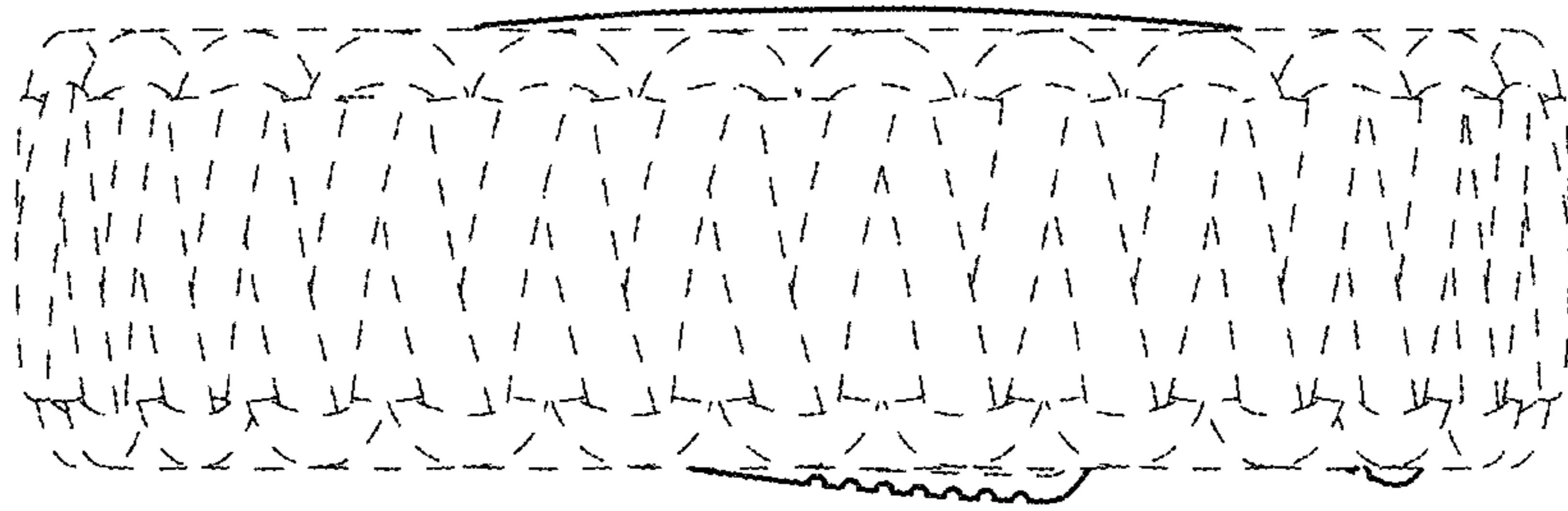

FIG. 20

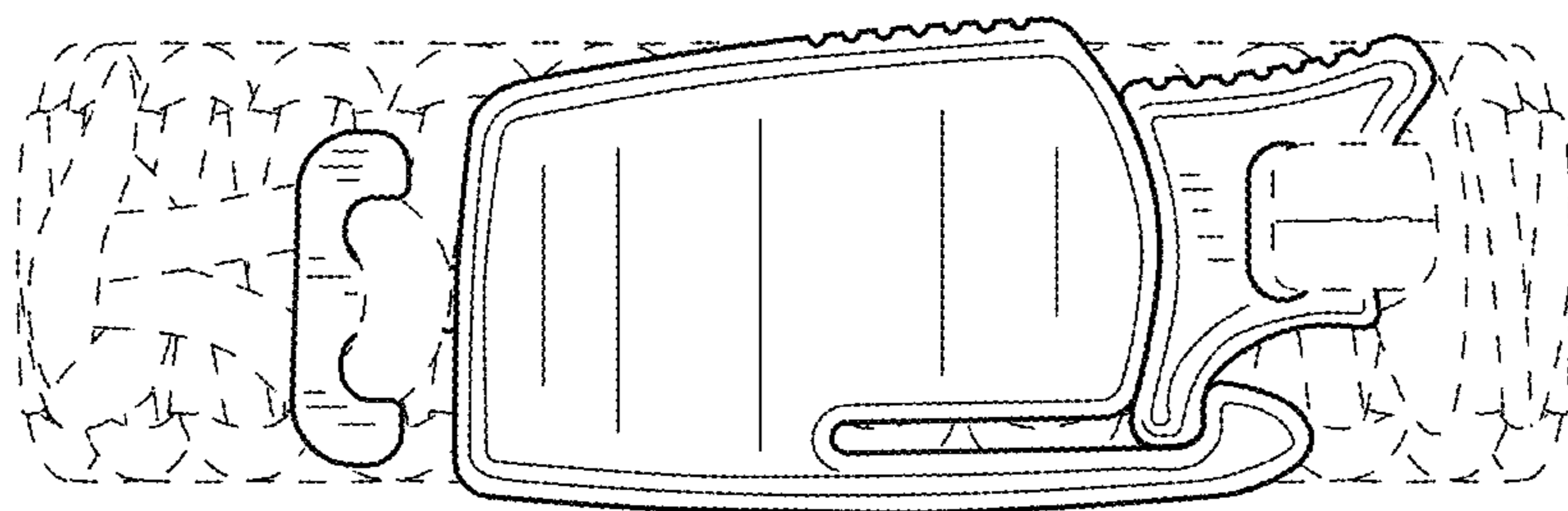

FIG. 21

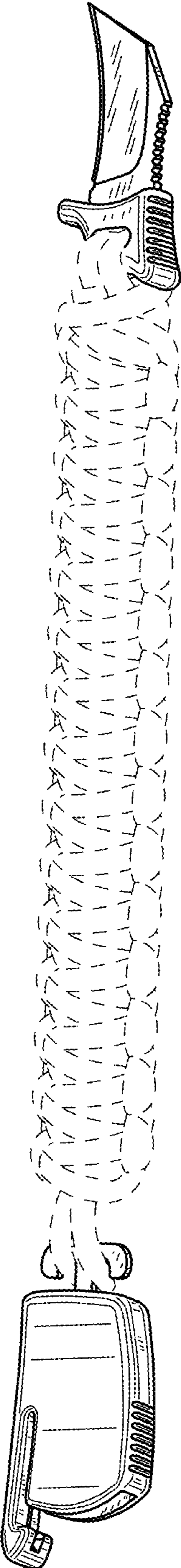

FIG.22

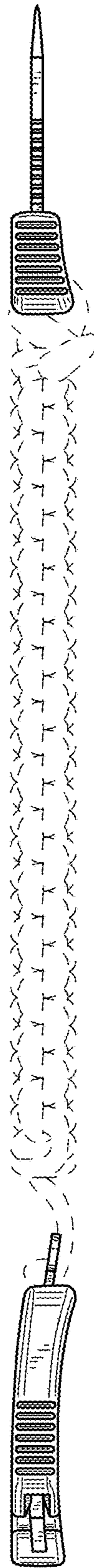

FIG. 23

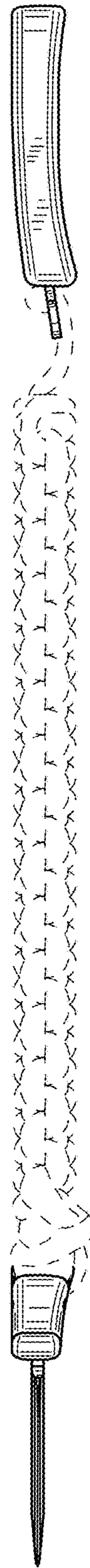

FIG. 24

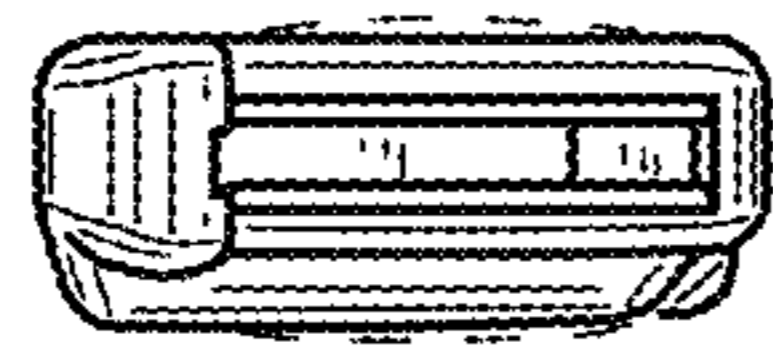

FIG.25

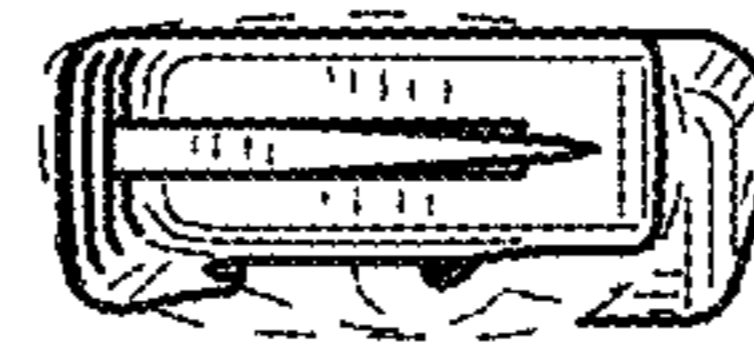

FIG.26

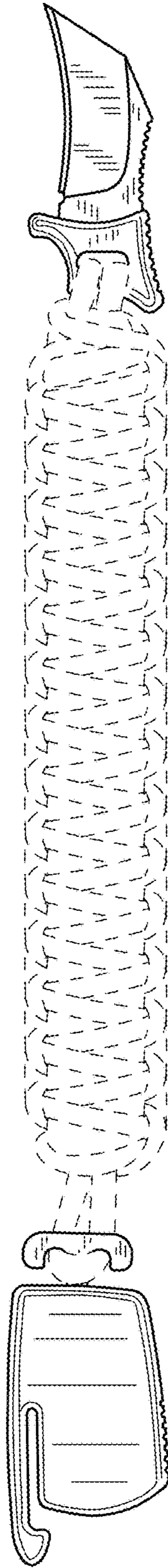

FIG. 27

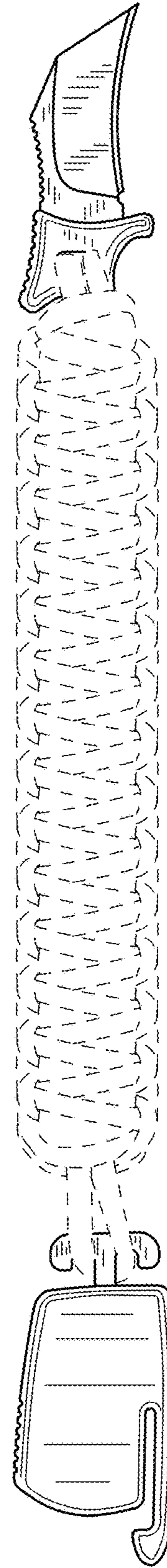

FIG. 28