



US00D808220S

(12) **United States Design Patent** (10) **Patent No.:** **US D808,220 S**
Burns et al. (45) **Date of Patent:** **** Jan. 23, 2018**

(54) **GROWLER BOTTLE**

FOREIGN PATENT DOCUMENTS

(71) Applicant: **Can't Live Without It, LLC**, New York, NY (US)

CN 202464499 10/2012
CN 202642309 2/2013

(Continued)

(72) Inventors: **Clay Allen Burns**, New York, NY (US); **Sarah Kauss**, New York, NY (US); **James Best**, Hewitt, NJ (US)

OTHER PUBLICATIONS

(73) Assignee: **CAN'T LIVE WITHOUT IT, LLC**, New York, NY (US)

Glass Milk Bottle; <http://betterbeveragebottles.com/17-oz-glass-water-bottle-virtually-unbreakable-with-thick-sides/>.

(Continued)

(**) Term: **15 Years**

Primary Examiner — Marianne Pandozzi

(21) Appl. No.: **29/585,032**

Assistant Examiner — Jae Liang

(22) Filed: **Nov. 18, 2016**

(74) *Attorney, Agent, or Firm* — Dentons US LLP

(51) **LOC (11) Cl.** **07-01**

(57) **CLAIM**

(52) **U.S. Cl.**

An ornamental design for a growler bottle, as shown and described.

USPC **D7/510; D7/511; D7/523**

(58) **Field of Classification Search**

DESCRIPTION

USPC D7/507, 509, 510, 511, 523, 529, 531, D7/532, 533, 534, 608, 300.2, 591, 598, D7/601, 602, 387, 392.1, 396.2, 396.1, D7/398, 399, 397, 400, 516, 518, 519; D9/435, 436, 519, 549, 552, 556, 559, D9/439, 440, 434; D21/386; D24/196, D24/197; 220/592.16, 292.17, 705, 710, 220/495.03

FIG. 1 is a front perspective view of a first embodiment of a growler bottle showing our new design; FIG. 2 is a front elevational view thereof; FIG. 3 is a rear elevational thereof; FIG. 4 is a left-side elevational view thereof; FIG. 5 is a right-side elevational view thereof; FIG. 6 is a top view thereof; FIG. 7 is a bottom view thereof; FIG. 8 is a front perspective view of a second embodiment of a growler bottle; FIG. 9 is a front elevational view thereof; FIG. 10 is a rear elevational view thereof; FIG. 11 is a left-side elevational view thereof; FIG. 12 is a right-side elevational view thereof; FIG. 13 is a top view thereof; and, FIG. 14 is a bottom view thereof.

CPC A47G 19/22; A47G 19/2211; A47G 19/2216; A47G 19/2222; A47G 19/2233

See application file for complete search history.

The broken lines in the drawing depict portions of the growler bottle that form no part of the claimed design.

(56) **References Cited**

U.S. PATENT DOCUMENTS

D39,921 S * 4/1909 Boldt D9/500
D114,660 S * 5/1939 Kerckoff D9/500
D216,080 S * 11/1969 Lawton D9/501
3,643,829 A 2/1972 Lachner
4,310,102 A 1/1982 Walter
D456,266 S 4/2002 Cross et al.

(Continued)

1 Claim, 12 Drawing Sheets

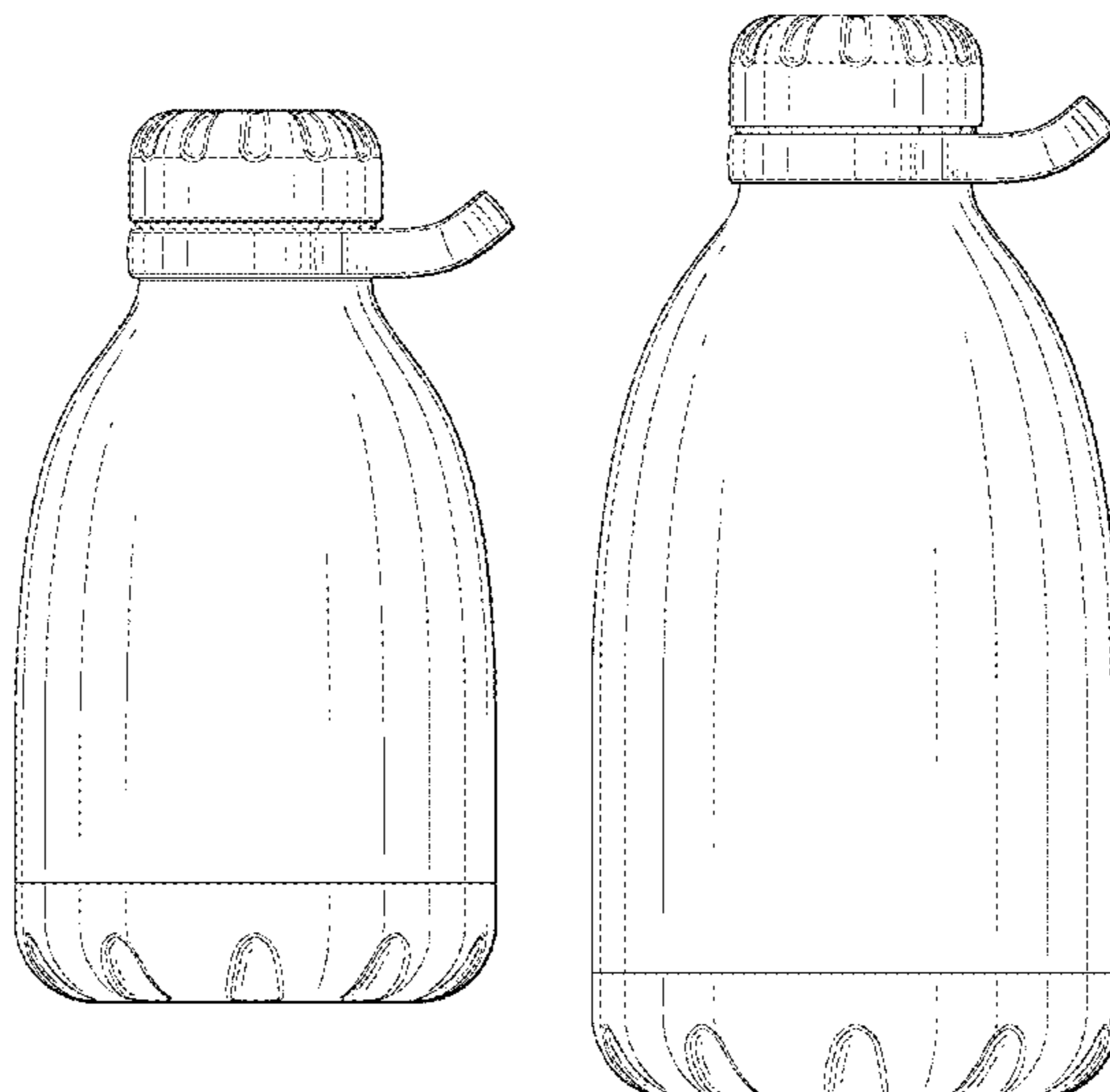

(56)

References Cited

U.S. PATENT DOCUMENTS

D544,300 S * 6/2007 Tien D7/510
 D554,000 S * 10/2007 Walsh B65D 1/0207
 D9/772
 D571,665 S 6/2008 Sanders
 D581,278 S * 11/2008 Shibata D9/453
 D611,833 S 3/2010 Taylor et al.
 D621,220 S * 8/2010 Lown D7/300.1
 D639,114 S * 6/2011 Swinford D7/396.2
 D655,136 S 3/2012 Goodman
 D656,403 S * 3/2012 Bernstein D9/529
 D658,450 S * 5/2012 Ying D7/608
 D664,856 S * 8/2012 Ring D9/453
 D672,198 S * 12/2012 Soltz D7/507
 D672,609 S * 12/2012 Aziz D7/507
 D683,187 S * 5/2013 Gold D7/510
 D686,871 S * 7/2013 Lane D7/392.1
 D700,012 S * 2/2014 Hurley D7/392.1
 D724,385 S * 3/2015 Hurley D7/511
 D731,856 S * 6/2015 Hill A47G 19/2266
 D7/532
 D748,943 S * 2/2016 Miller D7/392.1
 D756,702 S * 5/2016 Joseph D7/392.1
 D758,189 S * 6/2016 Roth D7/392.1
 D774,363 S * 12/2016 Seiders D7/608
 D774,826 S * 12/2016 Boroski D7/510
 2015/0251811 A1 9/2015 Glaser et al.

FOREIGN PATENT DOCUMENTS

CN 103482182 1/2014
 DE 202008007805 10/2008

OTHER PUBLICATIONS

Glass Milk Bottle Plastic Handles; <http://www.redhillgeneralstore.com/housewares/kitchen/kitacc/Glass-Milk-Bottles.htm>.
 Stainless Steel Water Bottle; <http://www.giftbazaar.in/stainless-steel-water-bottle-single-wall-blue-750-ml.html>.
 Water Bottle Polycarbonate; <http://www.ebay.com/itm/Water-Bottle-Polycarbonate-Natural-Blue-1-89-L-64-oz-Square-With-Red-Handle-USA-/301088813816>.
 Metal Water Storage Bottle with Handle; <http://www.ebay.com/itm/Metal-Water-Storage-Bottle-With-Handle-/262572399593>.
 AquaFlask; <http://www.theaquafask.com/shop-2/aquafask-insulated-double-wall-stainless-steel-water-bottle-with-handle-27-ounce-glossy-stainless-steel>.
 Personalized Stainless Steel Water Bottles; <https://ecopromotionsonline.com/products/bpa-free-drinkware-reusable-water-bottles-new-eco-friendly-products/personalized-stainles-0>.
 Goodlife Water Bottle; <http://travel.spotcoolstuff.com/water-bottle-review-comparison/goodlife-sigg-nalgene-gaiam-kor-one>.
 Stainless Steel Sports Bottle; http://www.diytrade.com/china/pd/7276391/Double_wall_Stainless_Steel_Sports_Bottle.html.
 Chilly's Bottle; <https://www.chillysbottles.com/>.
 Brimmalife; <http://brimmalife.com/collections/frontpage/products/brimma-17-oz-stainless-steel-water-bottle>.

* cited by examiner

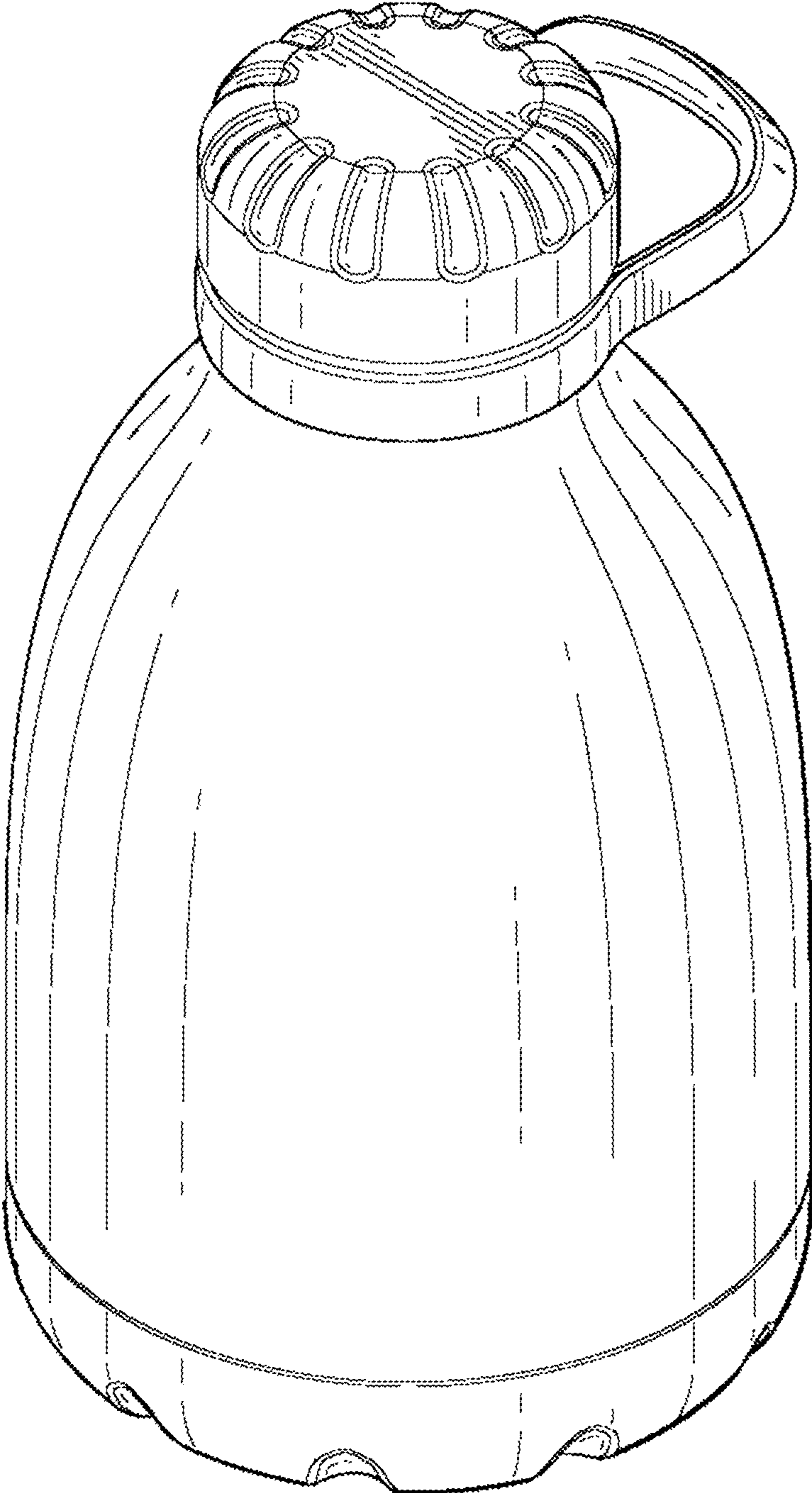

FIG. 1

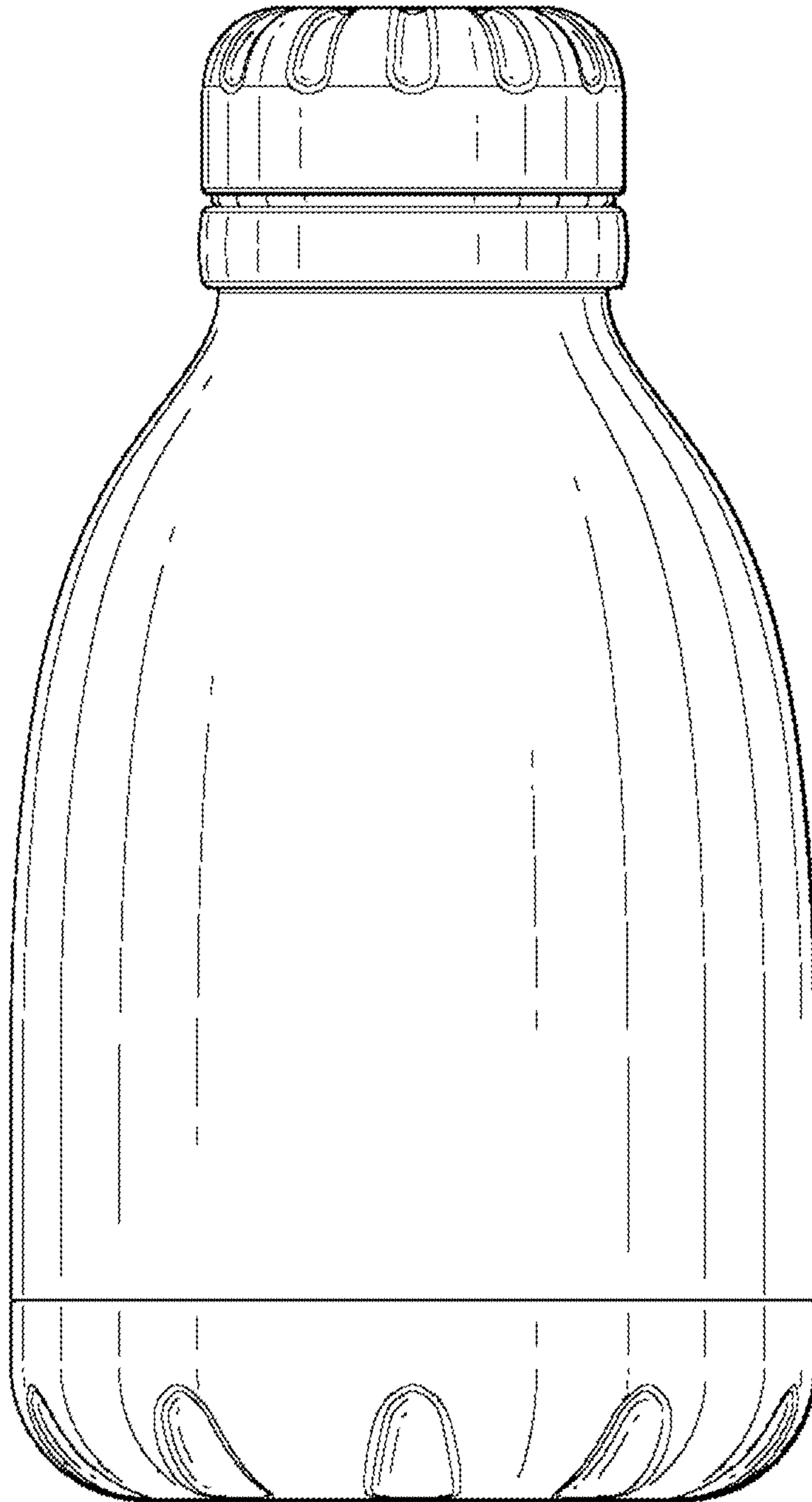

FIG. 2

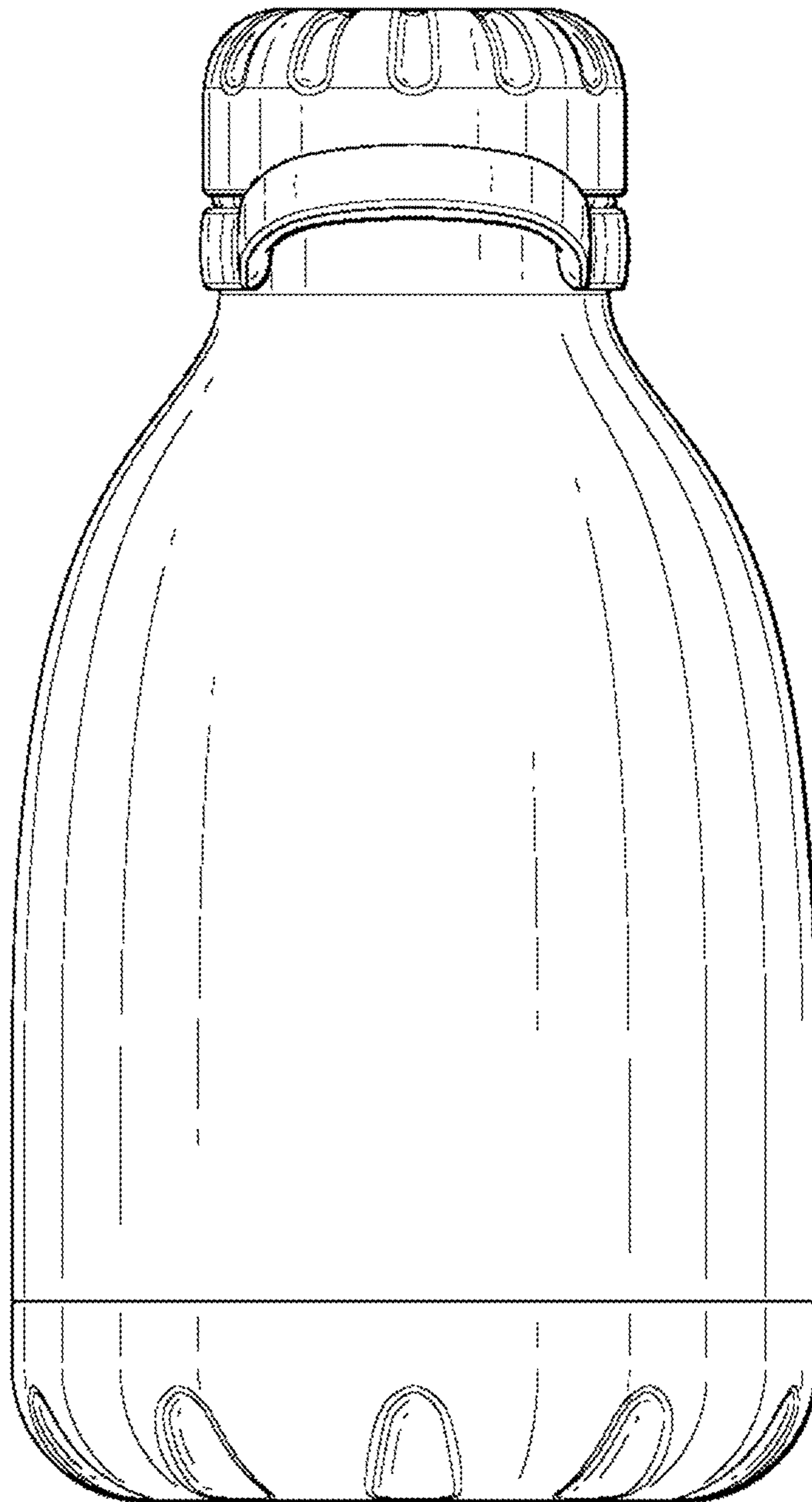

FIG. 3

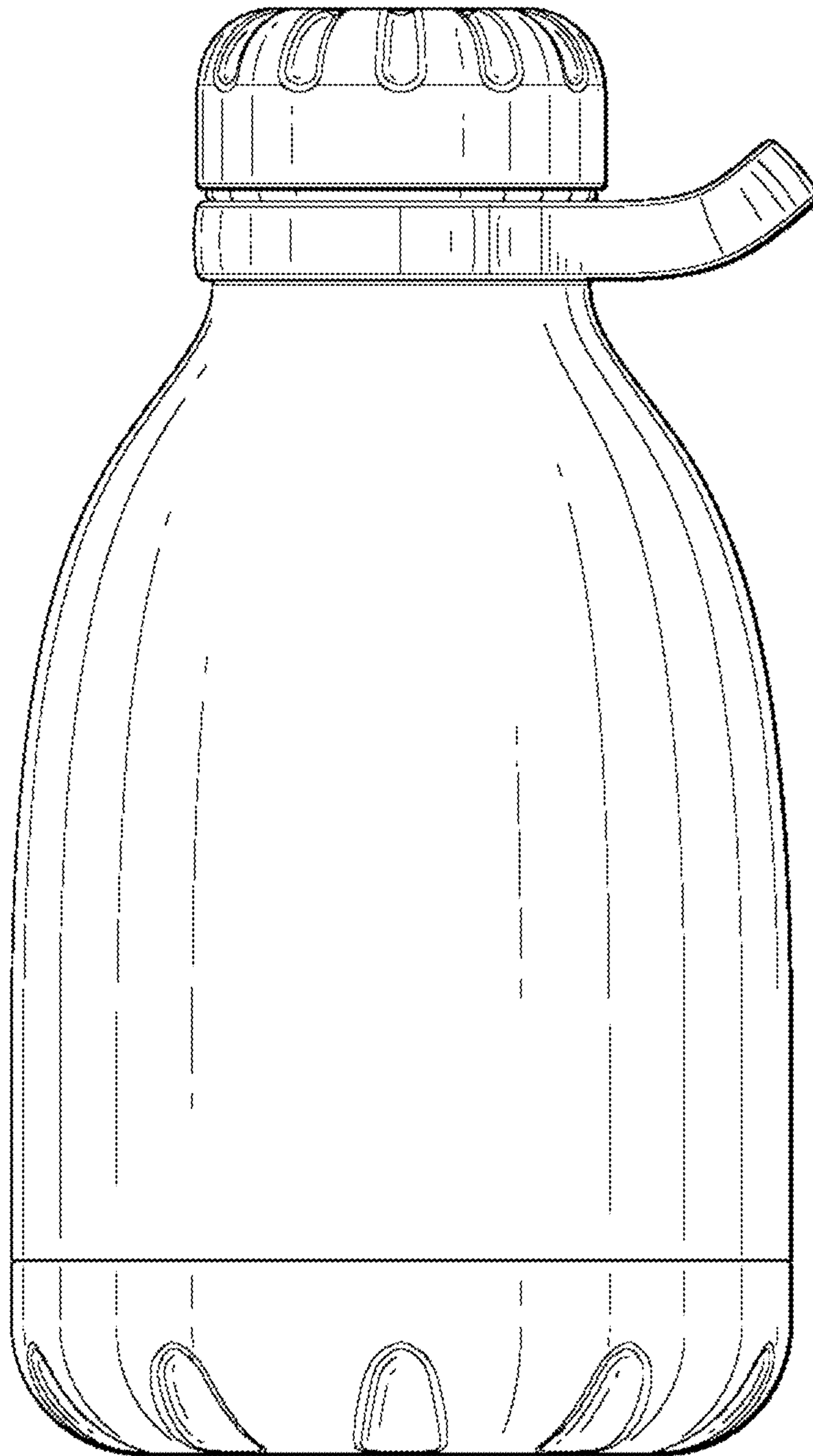

FIG. 4

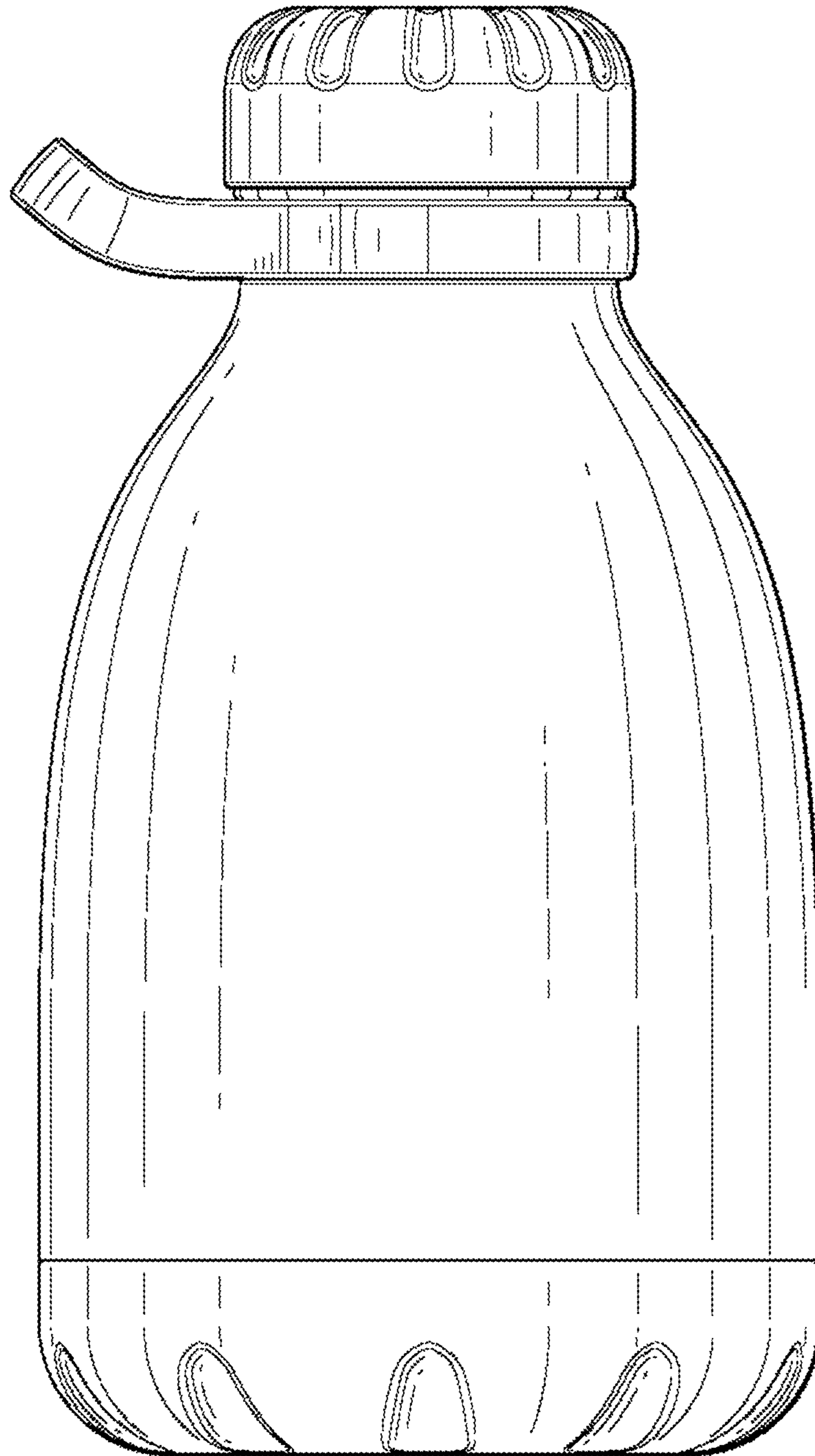

FIG. 5

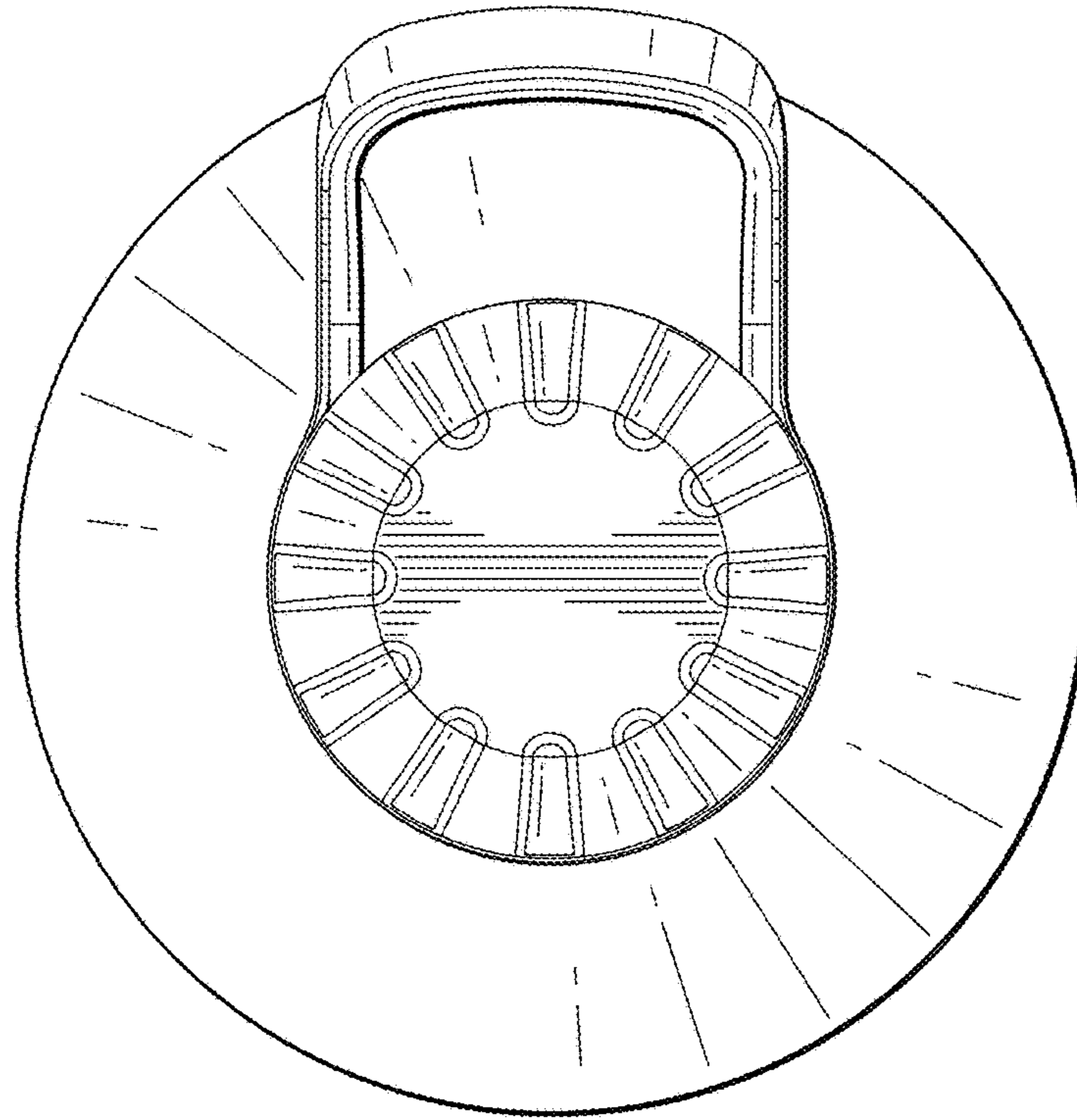

FIG. 6

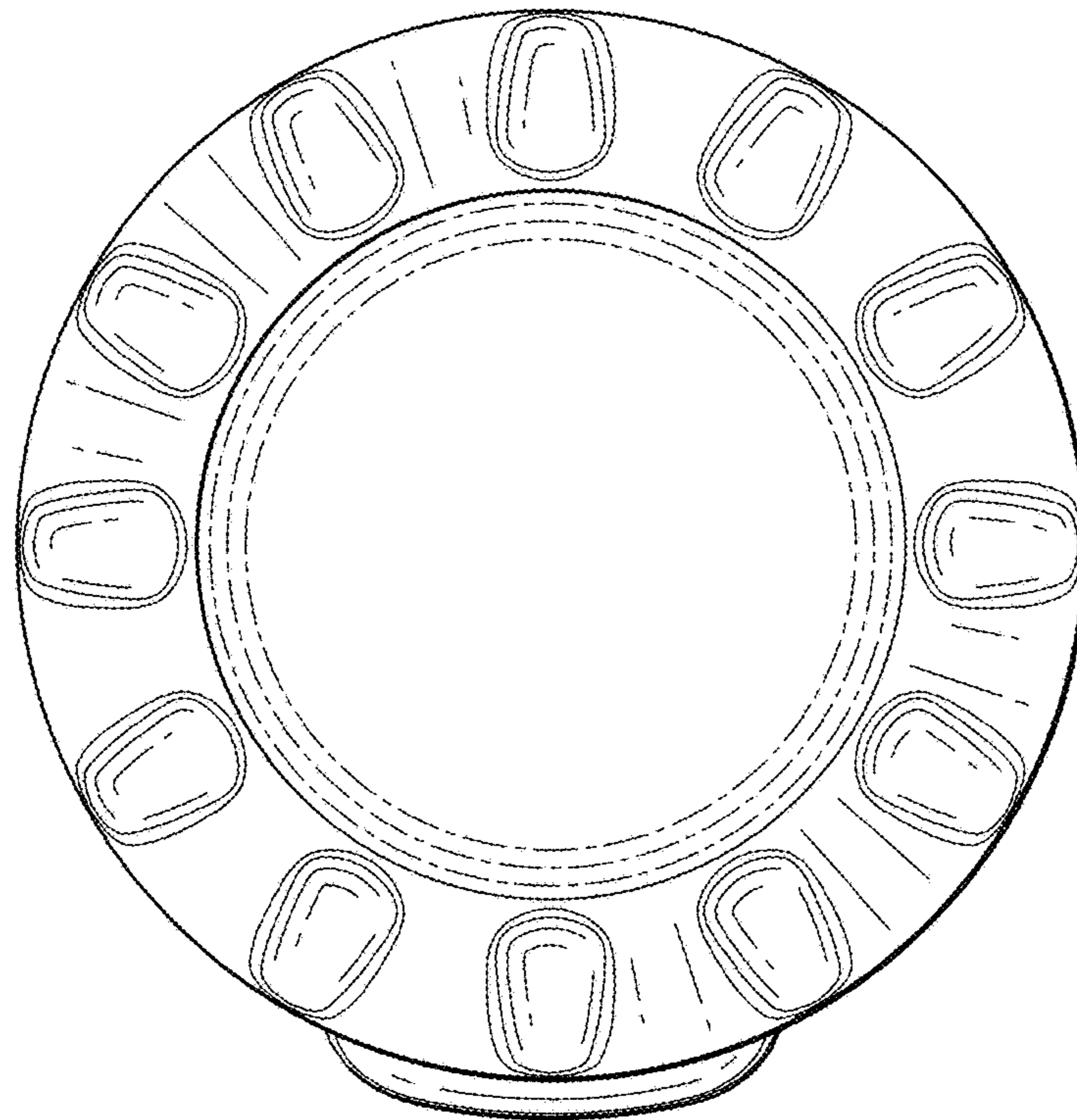

FIG. 7

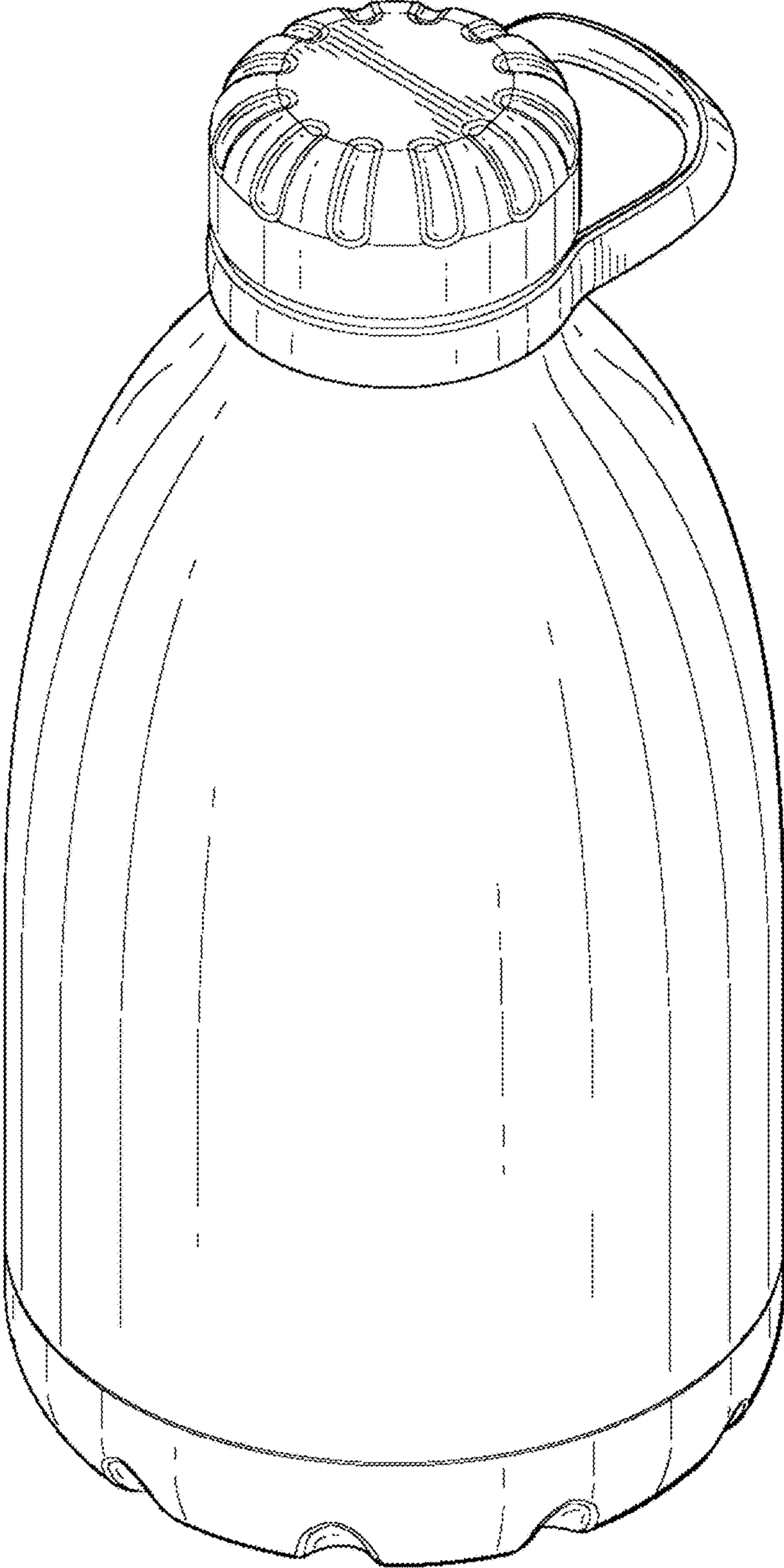

FIG. 8

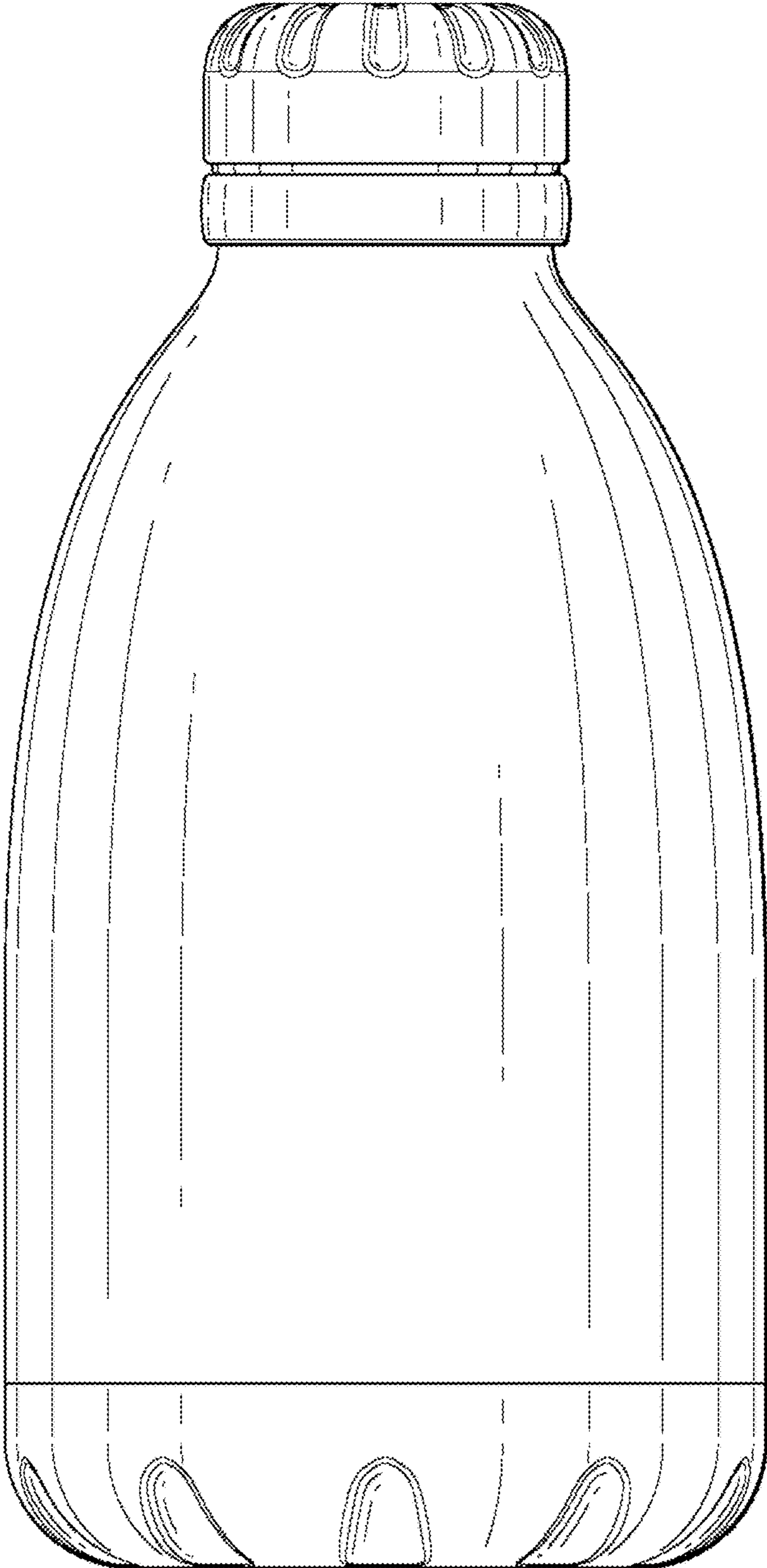

FIG. 9

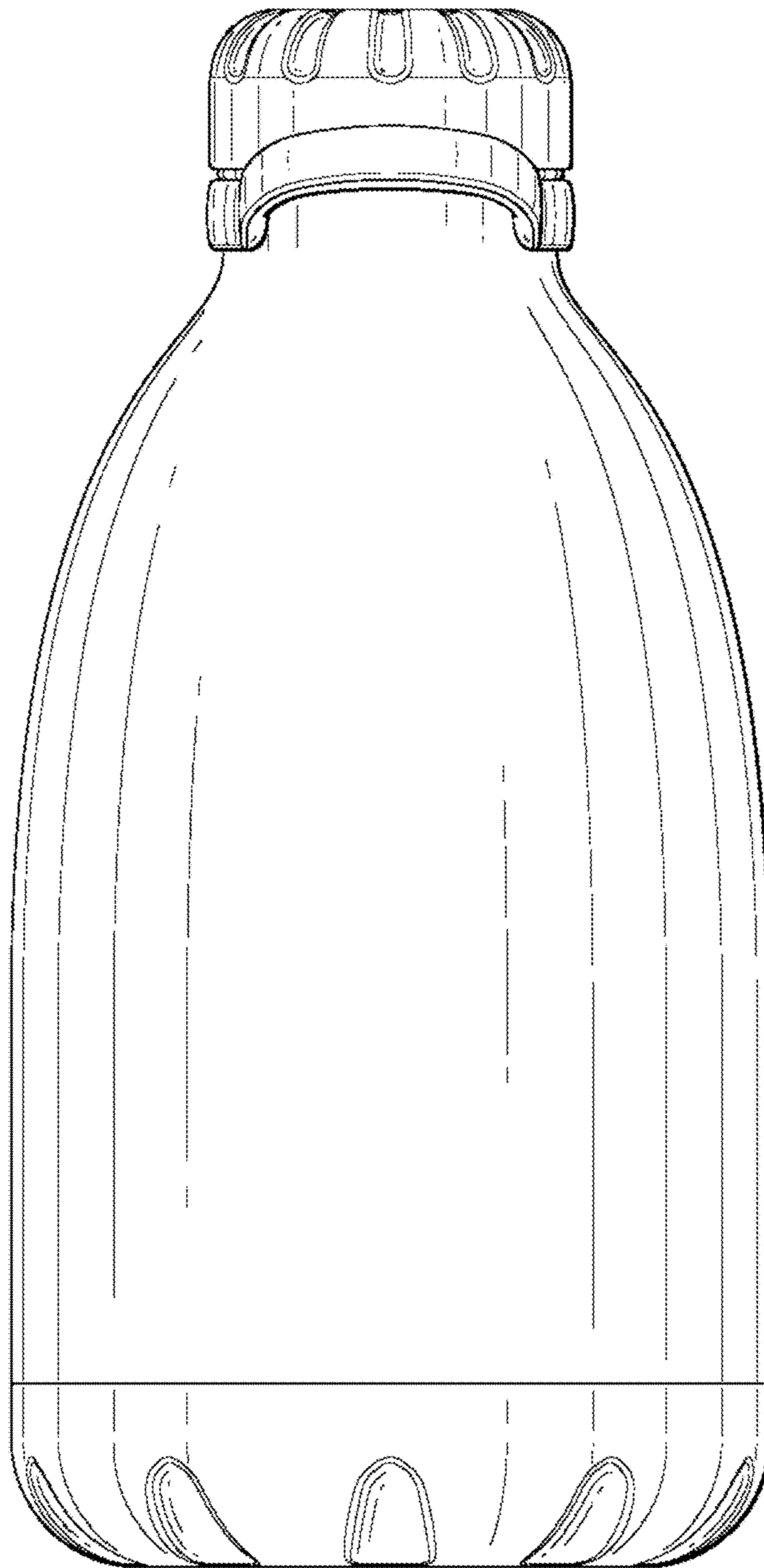

FIG. 10

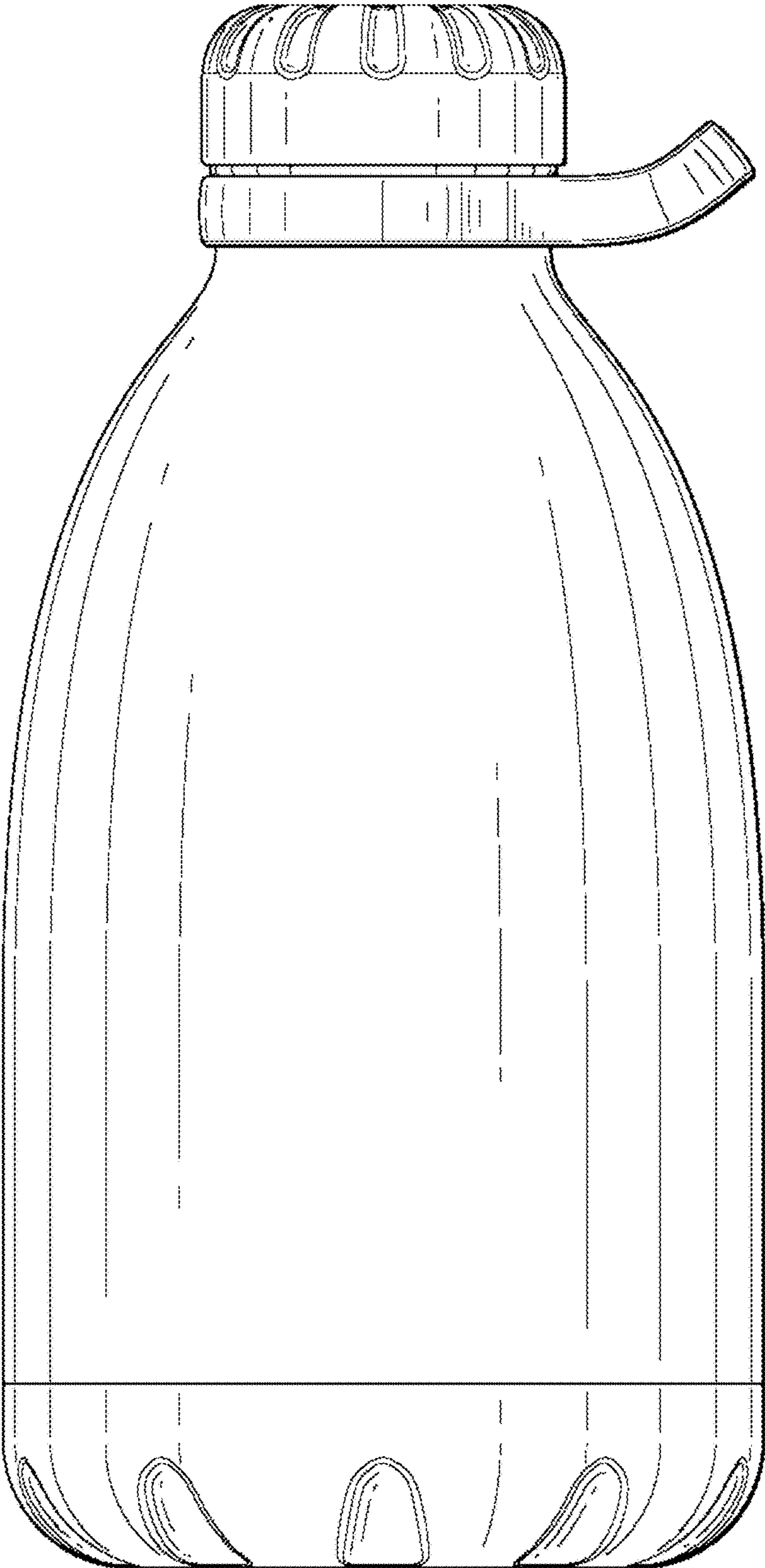

FIG. 11

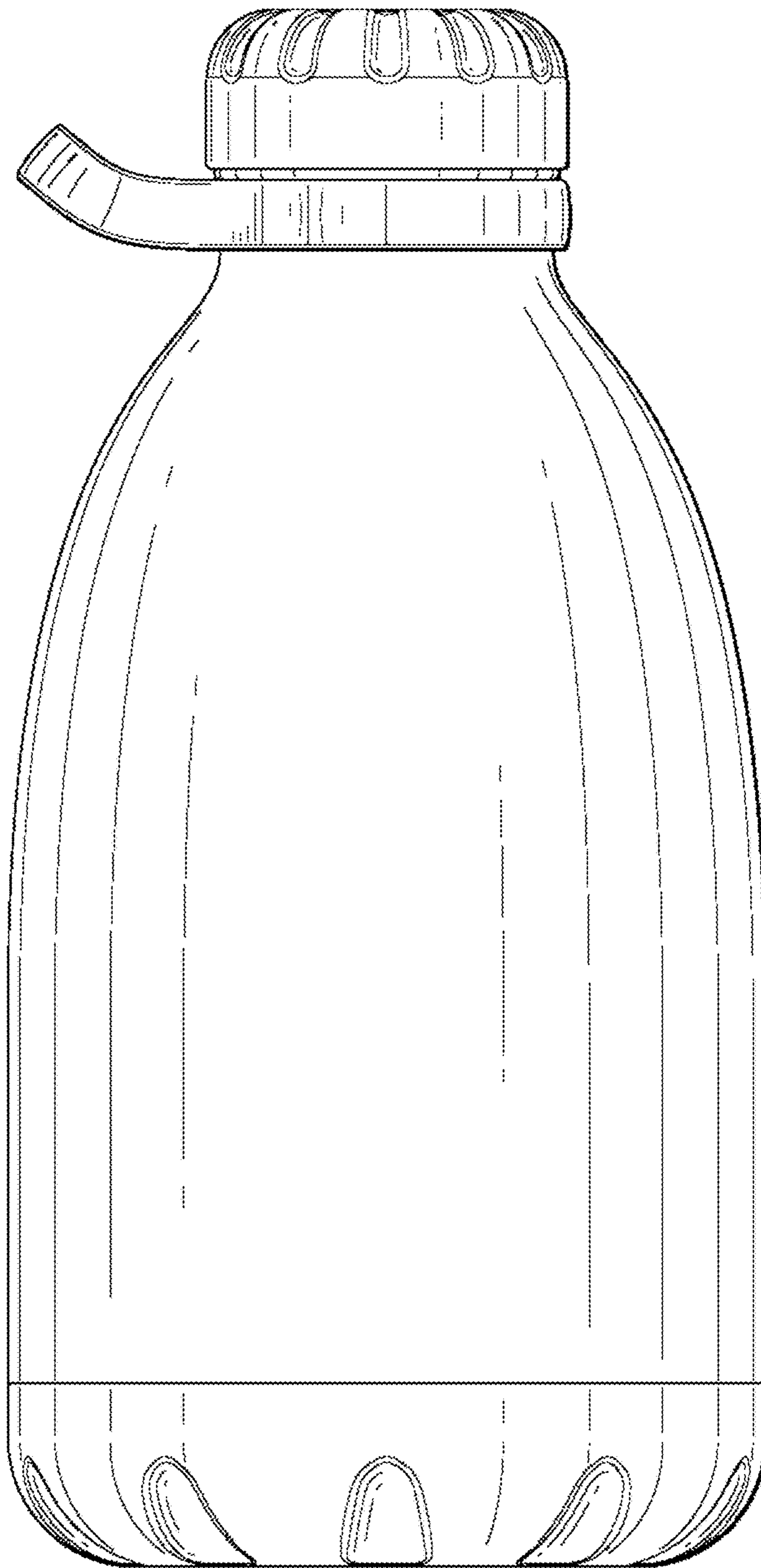

FIG. 12

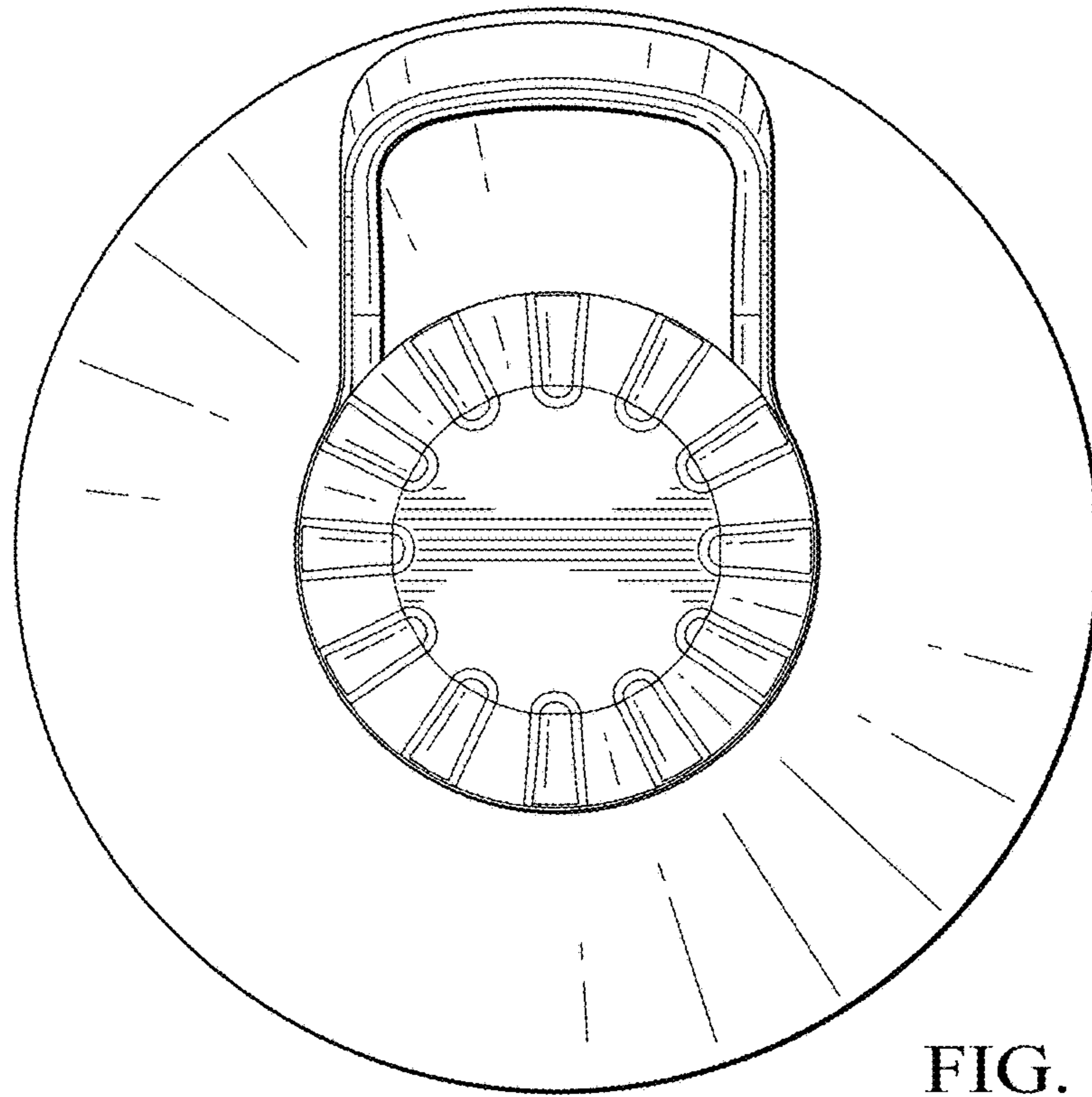

FIG. 13

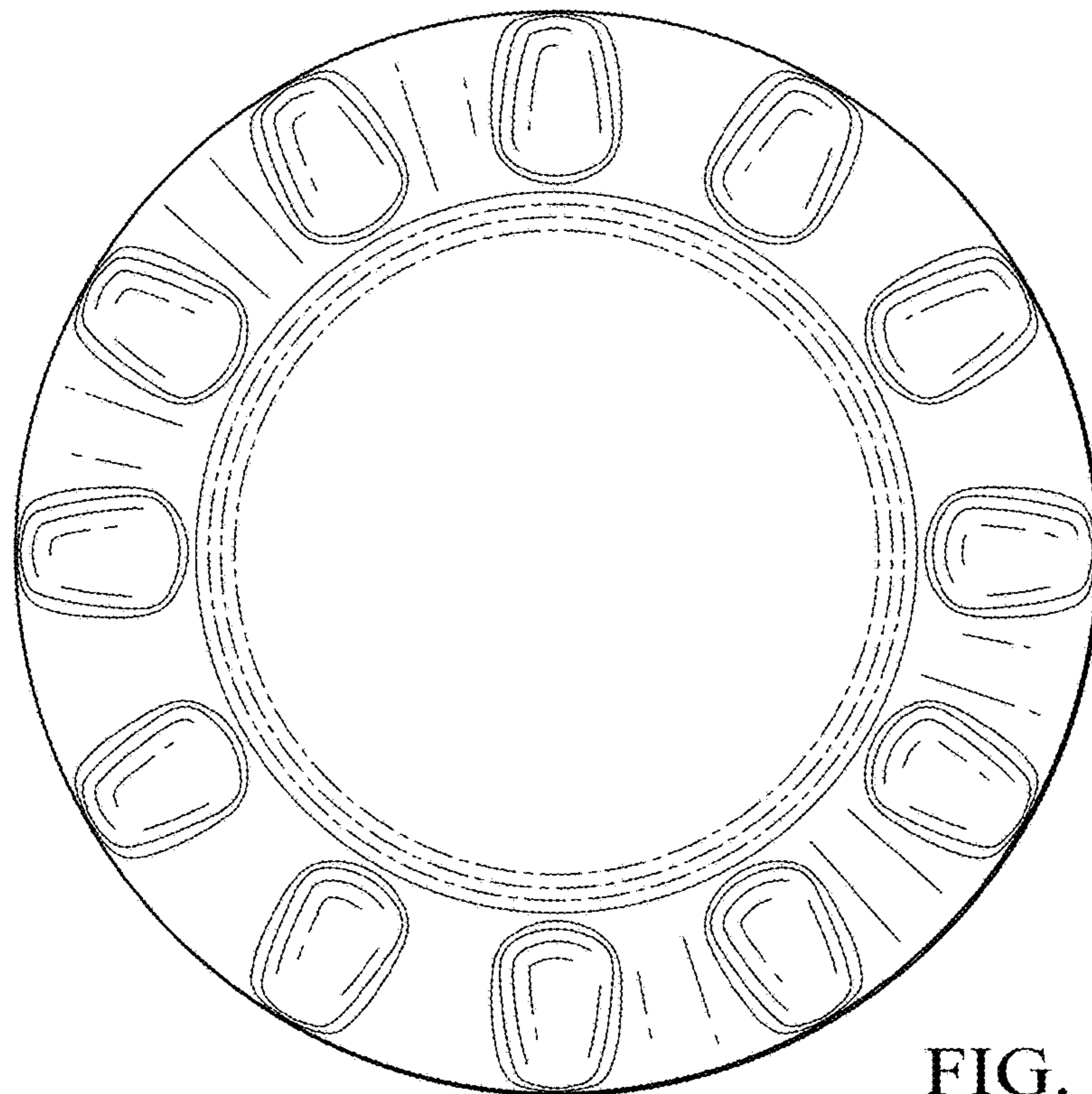

FIG. 14