



US00D808214S

(12) **United States Design Patent** (10) **Patent No.:** **US D808,214 S**  
**Yan** (45) **Date of Patent:** **\*\* Jan. 23, 2018**

(54) **CUP LID**

(56) **References Cited**

(71) Applicant: **ANHUI HENGXIN ENVIRONMENTAL PROTECTION AND NEW MATERIAL CO., LTD,**  
Hefei (CN)

U.S. PATENT DOCUMENTS

D539,649	S	*	4/2007	Smith	.....	D9/435
D540,165	S	*	4/2007	Hollis	.....	D9/435
D540,167	S	*	4/2007	Smith	.....	D9/435
D592,056	S	*	5/2009	Tedford, Jr.	.....	D9/447
D635,855	S	*	4/2011	Smith	.....	D9/447
D752,436	S	*	3/2016	Crudgington	.....	D9/434
2015/0191282	A1	*	7/2015	Crudgington	.....	B29D 99/0096 220/254.7

(72) Inventor: **Deping Yan,** Hefei (CN)

(73) Assignee: **ANHUI HENGXIN ENVIRONMENTAL PROTECTION AND NEW MATERIAL CO., LTD,**  
Hefei (CN)

\* cited by examiner

*Primary Examiner* — Daniel Bui

*Assistant Examiner* — Andrew Kerr

(\*\*) Term: **15 Years**

(74) *Attorney, Agent, or Firm* — Maschoff Brennan

(21) Appl. No.: **29/578,334**

(57) **CLAIM**

The ornamental design for a cup lid, as shown and described.

(22) Filed: **Sep. 20, 2016**

**DESCRIPTION**

(30) **Foreign Application Priority Data**

Jul. 15, 2016 (CN) ..... 201630324939.3

(51) **LOC (11) Cl.** ..... **07-99**

(52) **U.S. Cl.**  
USPC ..... **D7/396.2; D7/510; D7/511**

(58) **Field of Classification Search**  
USPC ..... D7/396.2, 509; D9/434-436, 438, 443,  
D9/446, 447, 449, 450, 452-454, 715,  
D9/716

FIG. 1 is a front elevational view of a cup lid, showing our new design.

FIG. 2 is a rear elevational view thereof.

FIG. 3 is a left elevational view thereof.

FIG. 4 is a right elevational view thereof.

FIG. 5 is a top elevational view thereof.

FIG. 6 is a bottom elevational view thereof.

FIG. 7 is a perspective view of front side thereof.

FIG. 8 is another perspective view of front side thereof.

FIG. 9 is a perspective view of rear side thereof; and,

FIG. 10 is a cross-sectional view thereof, taken along line 10-10 of FIG. 2.

CPC ..... A47G 23/02; B65D 23/10; B65D 23/12  
See application file for complete search history.

**1 Claim, 10 Drawing Sheets**

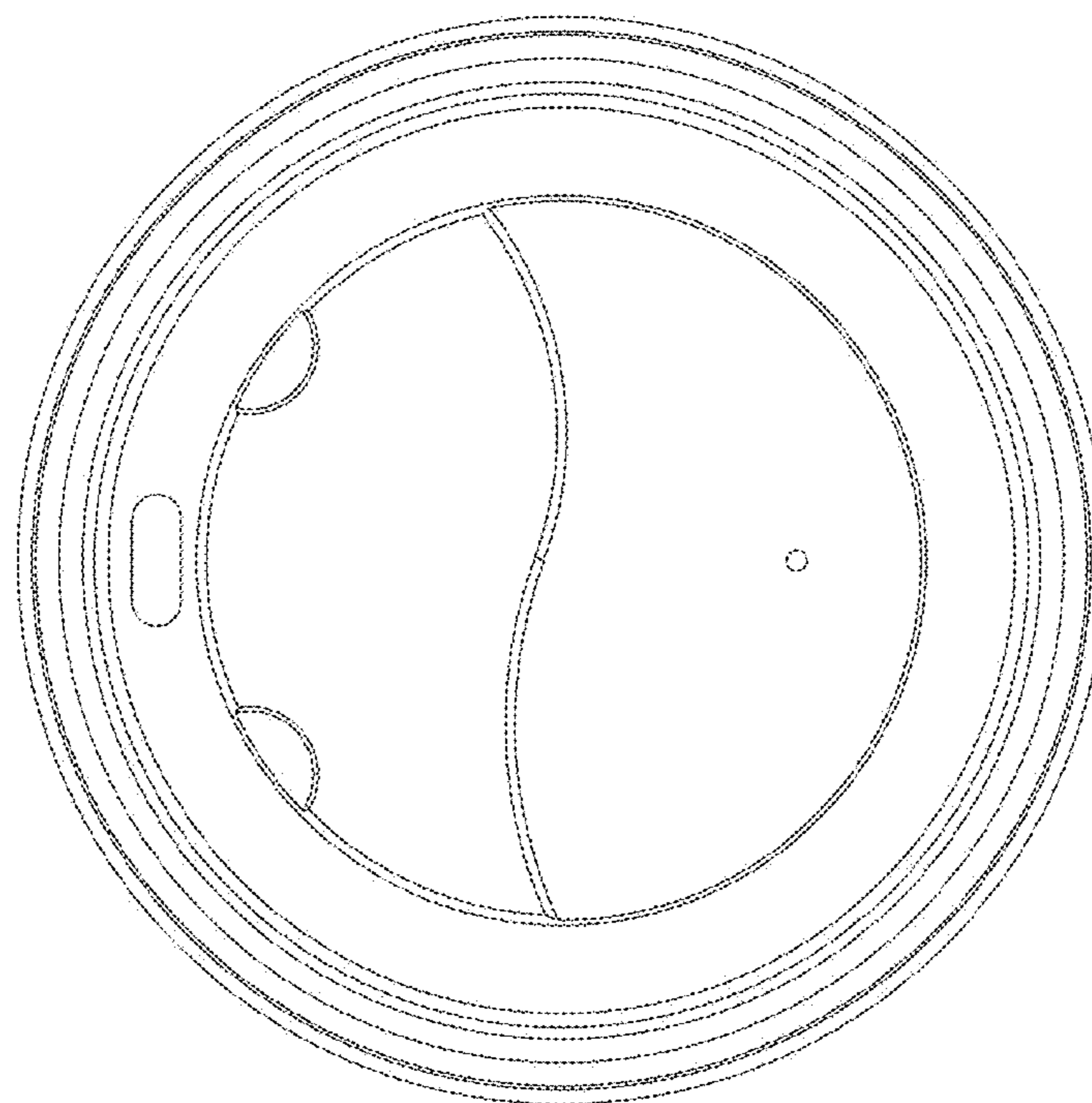

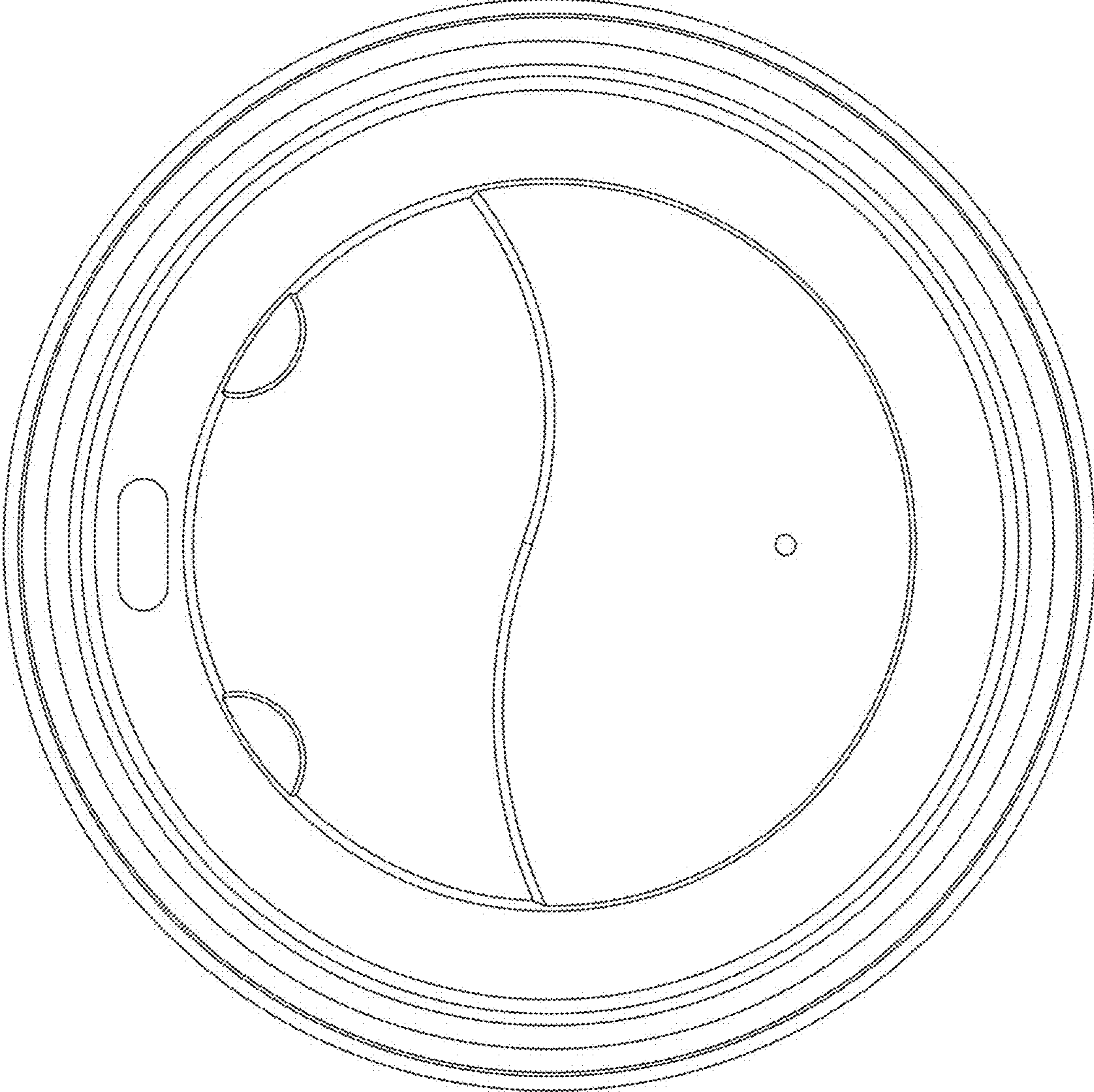

FIG. 1

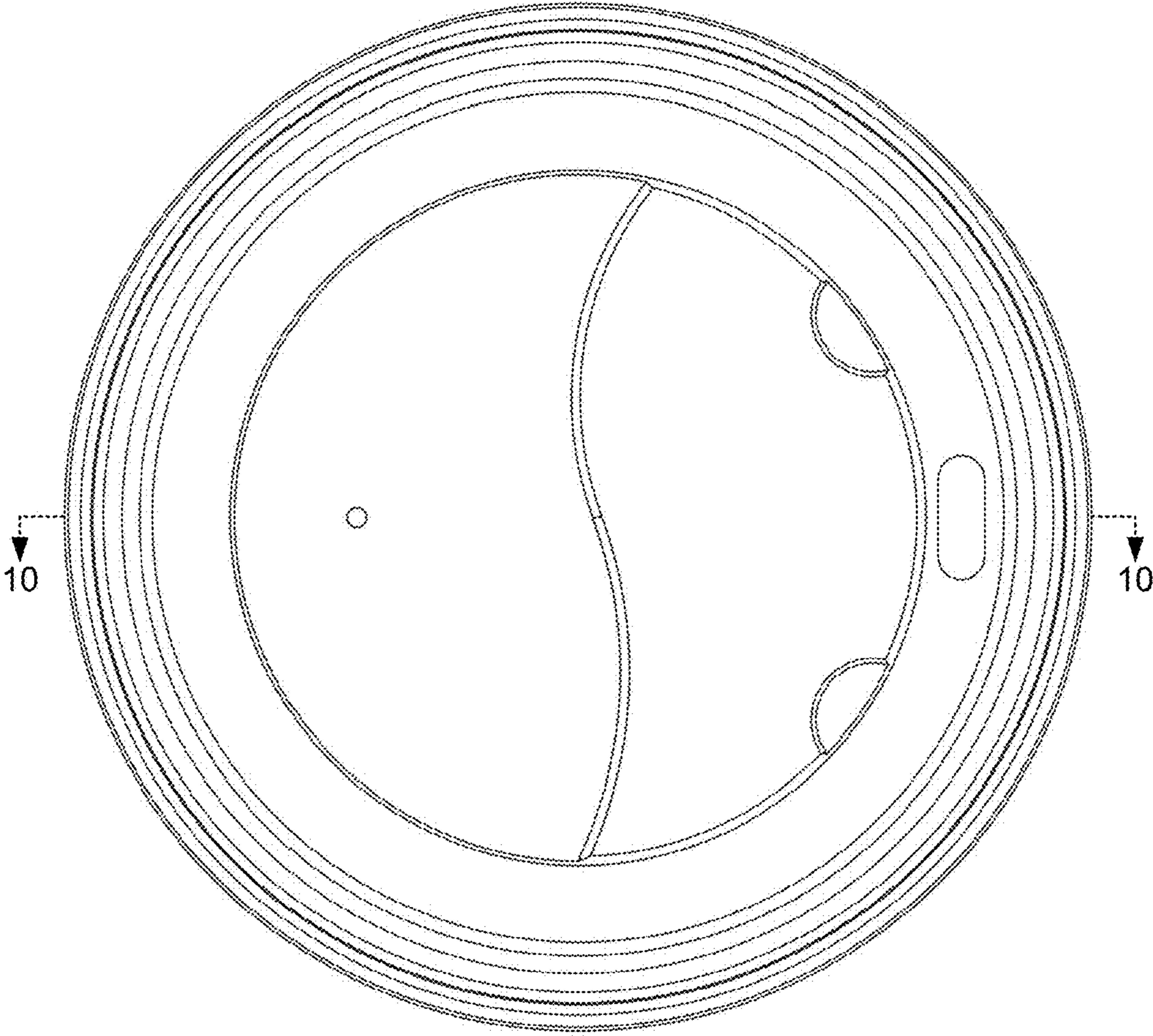

FIG 2

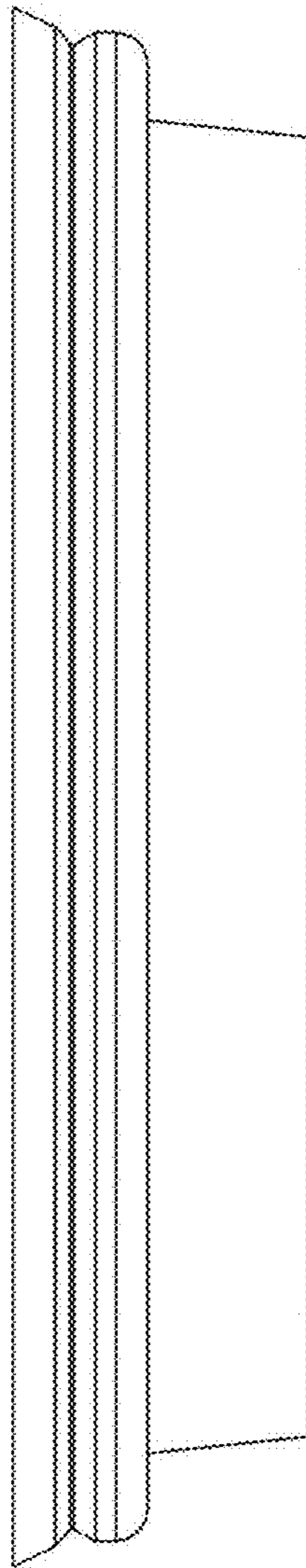

FIG. 3

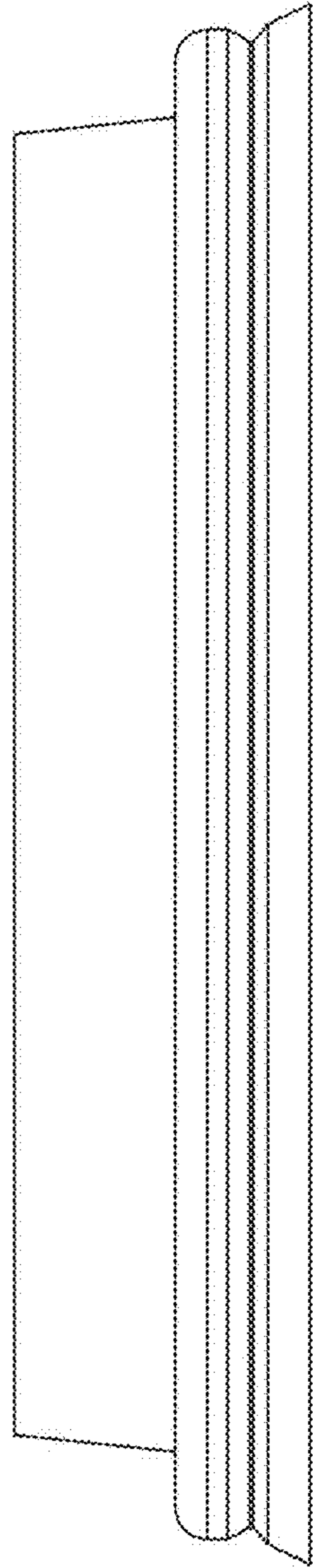

FIG. 4

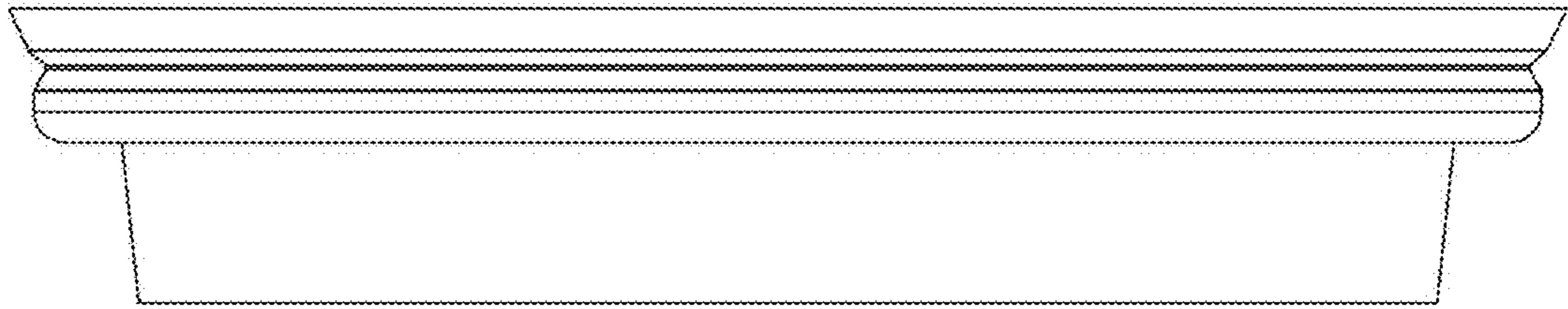

FIG. 5

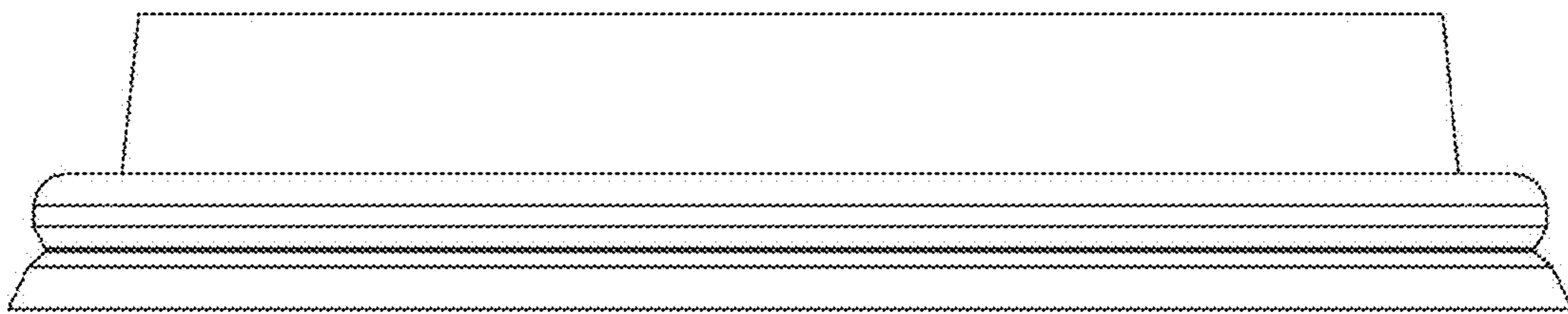

FIG. 6

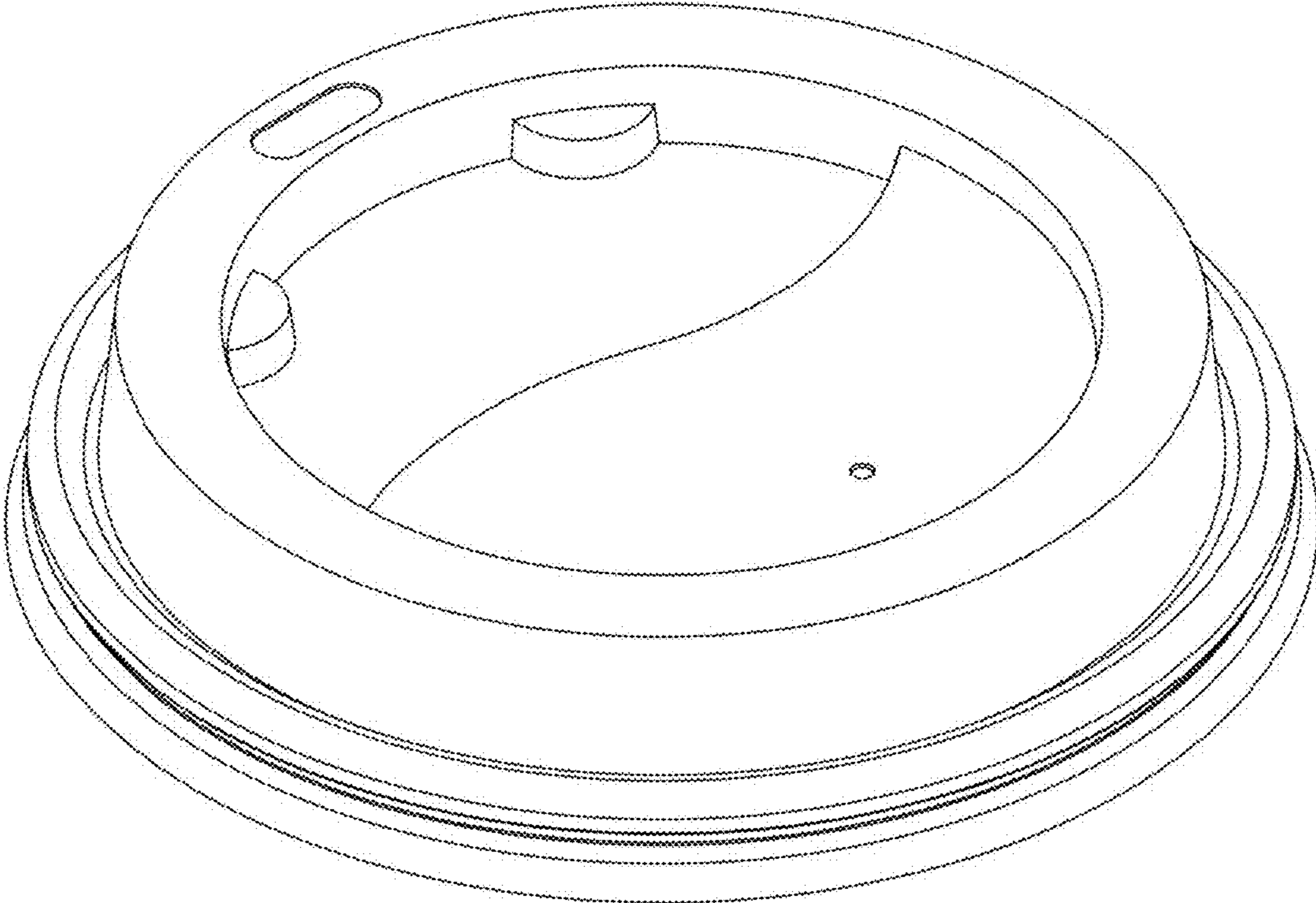

FIG. 7



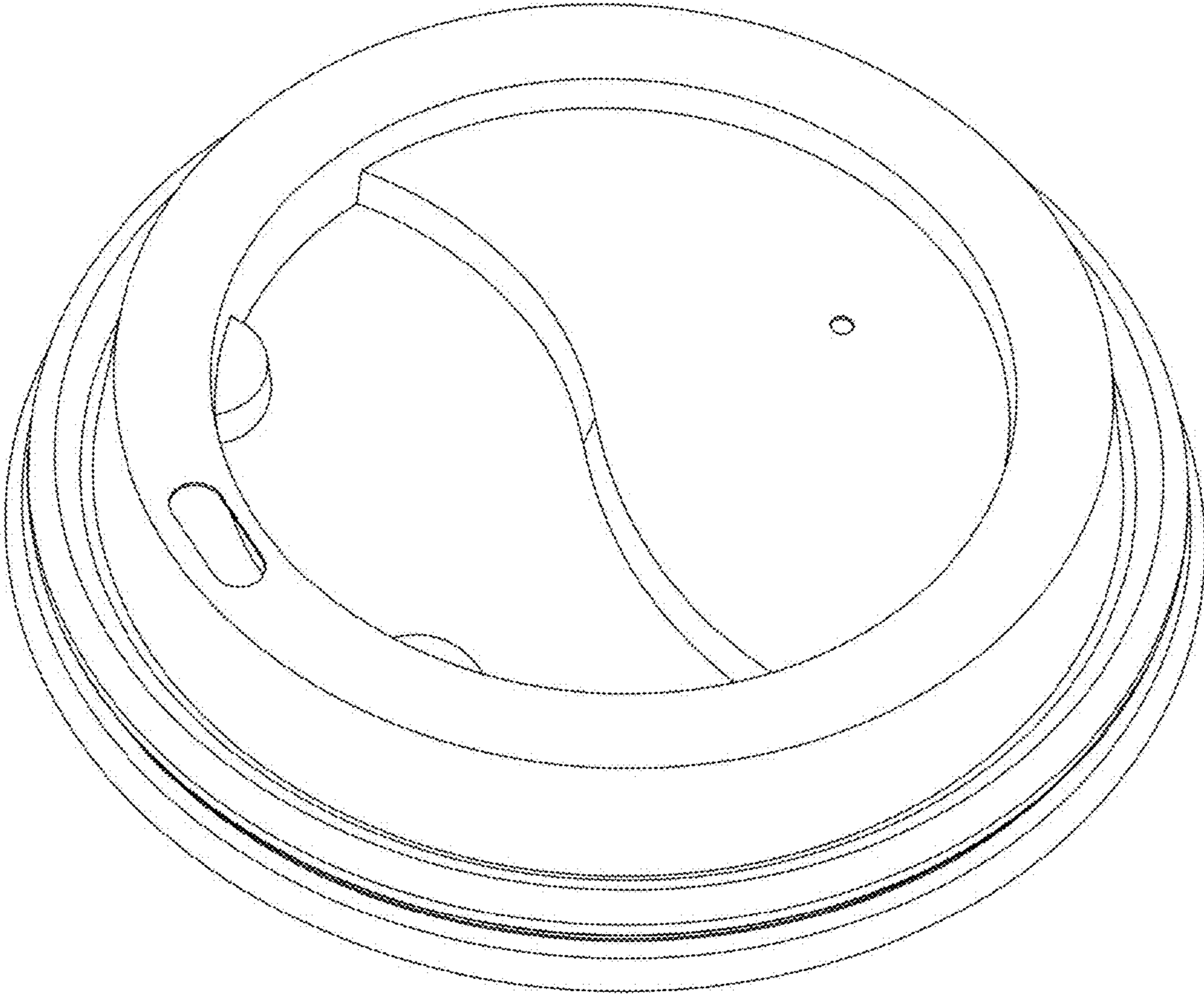

FIG. 8

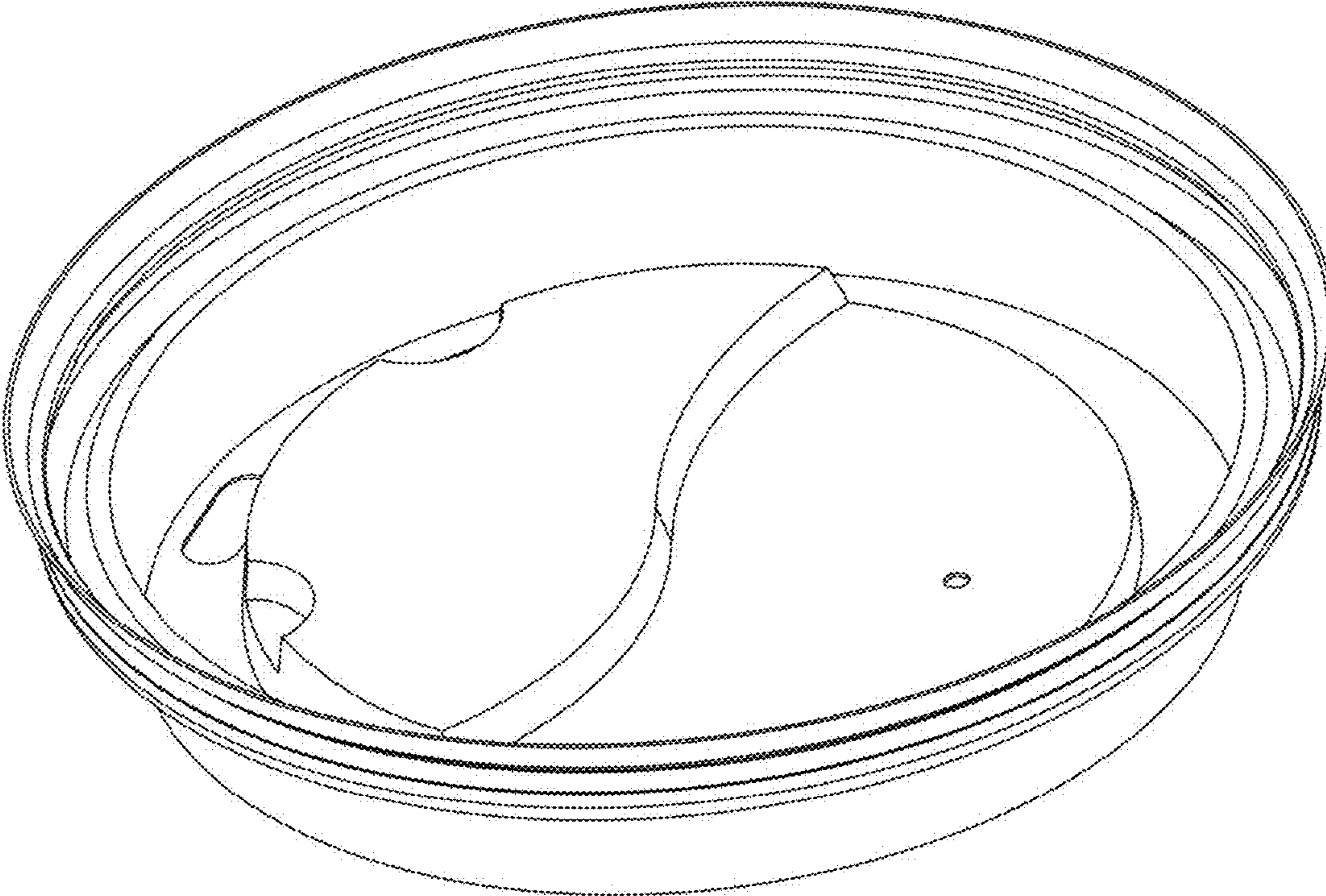

FIG. 9

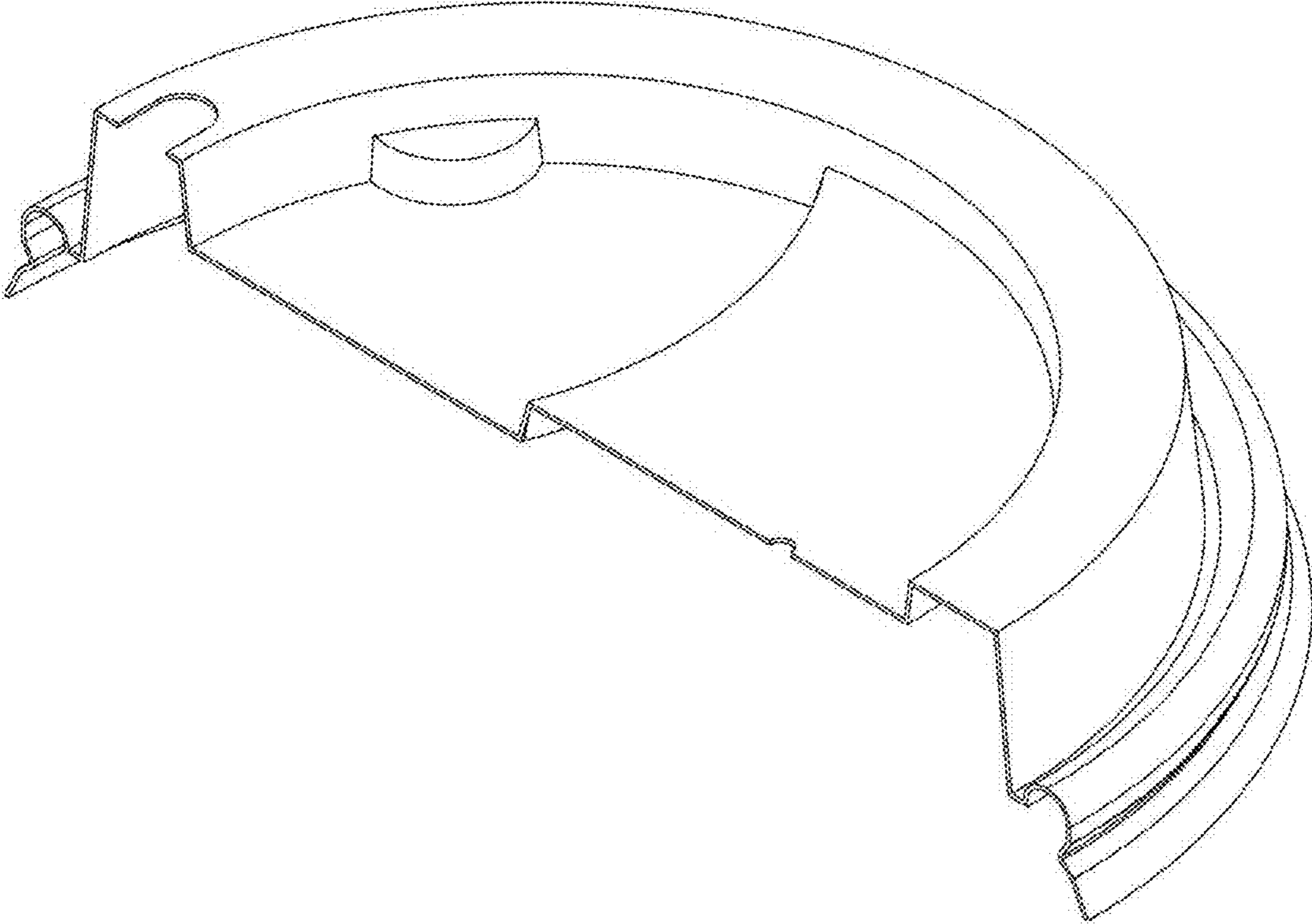

FIG. 10