



US00D808175S

(12) **United States Design Patent** (10) **Patent No.:** **US D808,175 S**
Seiders et al. (45) **Date of Patent:** **** Jan. 23, 2018**

(54) **DUFFEL BAG**
(71) Applicant: **YETI Coolers, LLC**, Austin, TX (US)
(72) Inventors: **Roy Joseph Seiders**, Austin, TX (US);
Erik Steven Larson, Austin, TX (US);
Derek G. Sullivan, Austin, TX (US);
Alex Baires, Austin, TX (US); **Jeff Munie**, Austin, TX (US)

7,207,426 B2 4/2007 Godshaw et al.
D548,966 S 8/2007 Aliberti et al.
7,334,684 B1 2/2008 Fontanilla et al.
7,344,028 B2 3/2008 Hanson
D575,059 S 8/2008 Cappiello et al.
7,597,478 B2 10/2009 Pruchnicki et al.
D609,466 S * 2/2010 Stulman D3/232
D620,708 S 8/2010 Sanz
(Continued)

(73) Assignee: **YETI Coolers, LLC**, Austin, TX (US)
(**) Term: **15 Years**

FOREIGN PATENT DOCUMENTS

CA 2300014 A1 8/2001
CA 2327764 A1 6/2002
(Continued)

(21) Appl. No.: **29/580,487**
(22) Filed: **Oct. 10, 2016**
(51) **LOC (11) Cl.** **03-01**
(52) **U.S. Cl.**
USPC **D3/318**
(58) **Field of Classification Search**
USPC D3/232, 246, 318, 327
CPC ... A45F 4/02; A45F 3/04; A45C 1/024; A45C
3/06
See application file for complete search history.

OTHER PUBLICATIONS

Amazon, "Seattle Sports FrostPak Soft Cooler", First reviewed Jun. 17, 2014, Accessed Jan. 31, 2016. (<https://www.amazon.com/Seattle-Sports-FrostPak-Soft-Cooler/dp/BOOLGZ28FI>).

Primary Examiner — Holly H Baynham
(74) *Attorney, Agent, or Firm* — Banner & Witcoff, Ltd.

(56) **References Cited**

U.S. PATENT DOCUMENTS

4,805,748 A * 2/1989 Gerch A45C 3/00
150/163
D307,668 S 5/1990 Young
5,005,679 A 4/1991 Hjelle
5,007,250 A 4/1991 Musielak
5,140,833 A 8/1992 Whalen
D434,900 S 12/2000 Spence, Jr. et al.
6,338,180 B1 1/2002 Massard
6,409,066 B1 6/2002 Schneider et al.
D465,924 S 11/2002 Gisser
D481,540 S 11/2003 Van Himbeeck
D495,489 S 9/2004 Messina-Brown
D509,959 S 9/2005 Nykoluk
D516,307 S 3/2006 Koenig et al.
D535,820 S * 1/2007 Kamiya D3/246

DESCRIPTION

FIG. 1 is a front, right perspective view of a duffel bag showing our new design;
FIG. 2 is a front view thereof;
FIG. 3 is a rear view thereof;
FIG. 4 is a right side view thereof;
FIG. 5 is a left side view thereof;
FIG. 6 is a top view thereof; and,
FIG. 7 is a bottom view thereof.
The broken lines immediately adjacent to the shaded area represent unclaimed boundaries of the design.

1 Claim, 6 Drawing Sheets

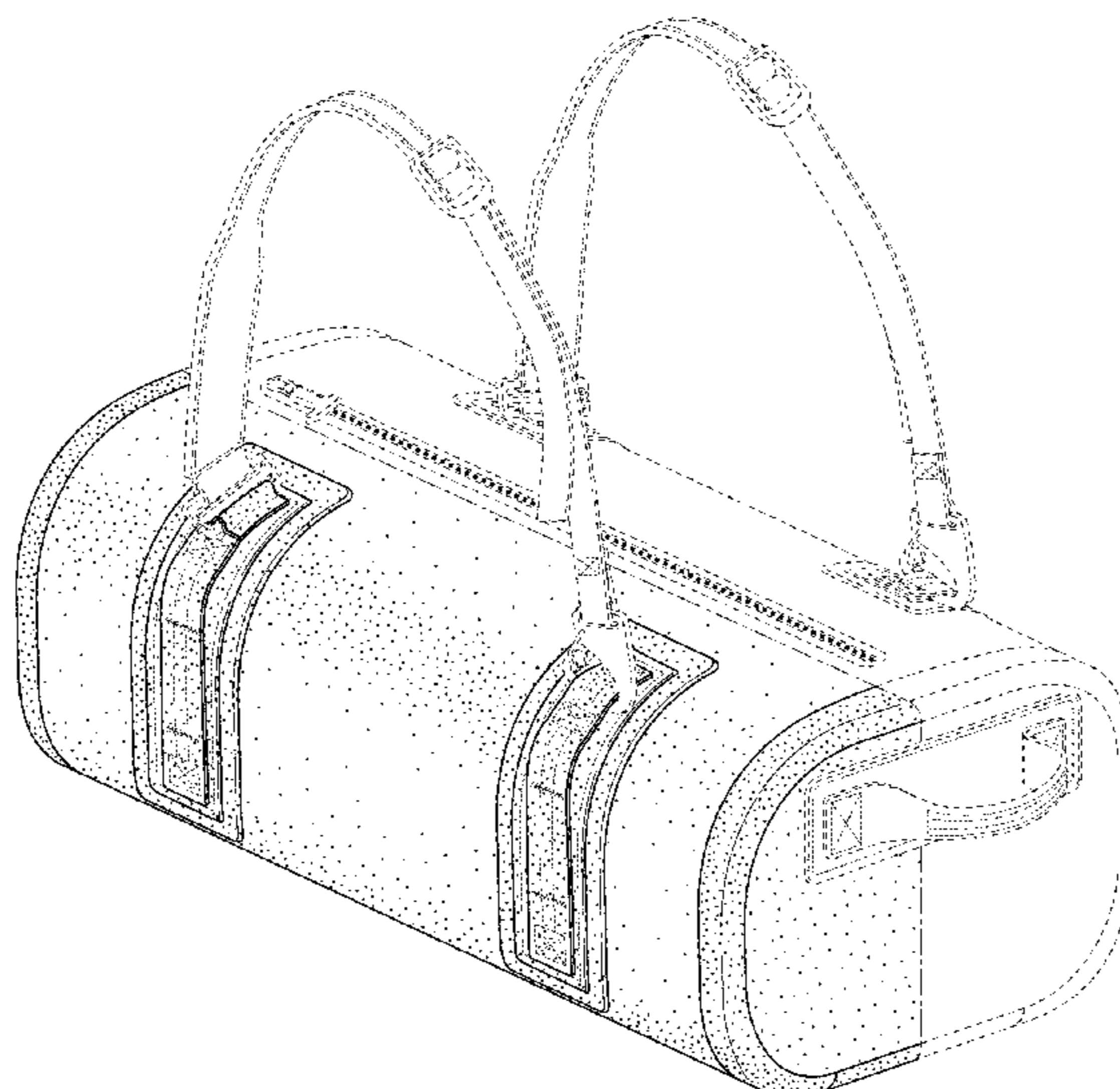

(56)

References Cited

U.S. PATENT DOCUMENTS

7,861,857 B2 1/2011 Vorderkunz
 D632,888 S * 2/2011 Jobert D3/232
 D648,533 S 11/2011 Sosnovsky
 D674,603 S 1/2013 Gerbi
 D688,457 S 8/2013 Harris
 D688,458 S 8/2013 Harris
 D689,283 S 9/2013 Berkowitz
 D692,662 S 11/2013 Pignotti
 D698,150 S 1/2014 Sabounjian
 8,695,770 B2 4/2014 Santy
 D713,639 S 9/2014 Whitlock et al.
 D717,040 S 11/2014 Swartzel et al.
 D725,903 S 4/2015 Kuster et al.
 D727,017 S 4/2015 Aberg et al.
 D732,824 S 6/2015 Tzortzis
 D738,107 S 9/2015 Adler et al.
 D738,108 S 9/2015 Adler et al.
 9,138,036 B2 9/2015 Andreasson et al.
 D740,550 S 10/2015 Shabou
 D740,551 S 10/2015 Shabou
 D740,552 S 10/2015 Shabou
 D742,646 S 11/2015 Amago
 D745,778 S 12/2015 Shabou
 9,215,918 B2 12/2015 Kao et al.
 D747,873 S 1/2016 Peng
 D749,318 S 2/2016 LoNigro
 D758,075 S 6/2016 Quarry et al.
 D761,562 S 7/2016 Venturini Fendi
 D766,571 S 9/2016 Boroski
 D782,820 S * 4/2017 Thompson D3/283
 D785,325 S * 5/2017 Samrelius D3/246
 2005/0263432 A1 12/2005 Hanson
 2006/0065500 A1 3/2006 Herrig
 2008/0142558 A1 6/2008 Dexter
 2014/0248003 A1 9/2014 Mogil et al.

2014/0270591 A1 9/2014 Joly
 2016/0206061 A1 7/2016 Ford
 2016/0278491 A1 9/2016 Amago

FOREIGN PATENT DOCUMENTS

CA 150323 12/2013
 CA 150461 12/2013
 CN 302623928 11/2013
 CN 302852751 6/2014
 CN 302946709 9/2014
 CN 303092550 2/2015
 CN 303620433 3/2016
 EM 002307702-0003 9/2013
 EM 002333591-0015 10/2013
 EM 002348797-0001 11/2013
 EM 002309591-0001 12/2013
 EM 002309591-0002 12/2013
 EM 002309591-0003 12/2013
 EM 002309591-0005 12/2013
 EM 002309591-0006 12/2013
 EM 002309591-0007 12/2013
 EM 002309591-0008 12/2013
 EM 002309591-0009 12/2013
 EM 002520213-0005 8/2014
 EM 002599944-0001 1/2015
 EM 002629964-0001 2/2015
 EM 002119362-0001 4/2015
 EM 002639724-0002 5/2015
 EM 002734988-0003 7/2015
 EM 002734988-0004 7/2015
 EM 002760678-0005 9/2015
 EM 002906594-0010 12/2015
 EM 003146869-0001 8/2016
 EM 003359199-0001 9/2016
 EM 003359199-0002 9/2016
 GB 4041233 8/2015
 JP D1475659 7/2013
 KR 300687326.0000 4/2013
 WO D079659-001 12/2012

* cited by examiner

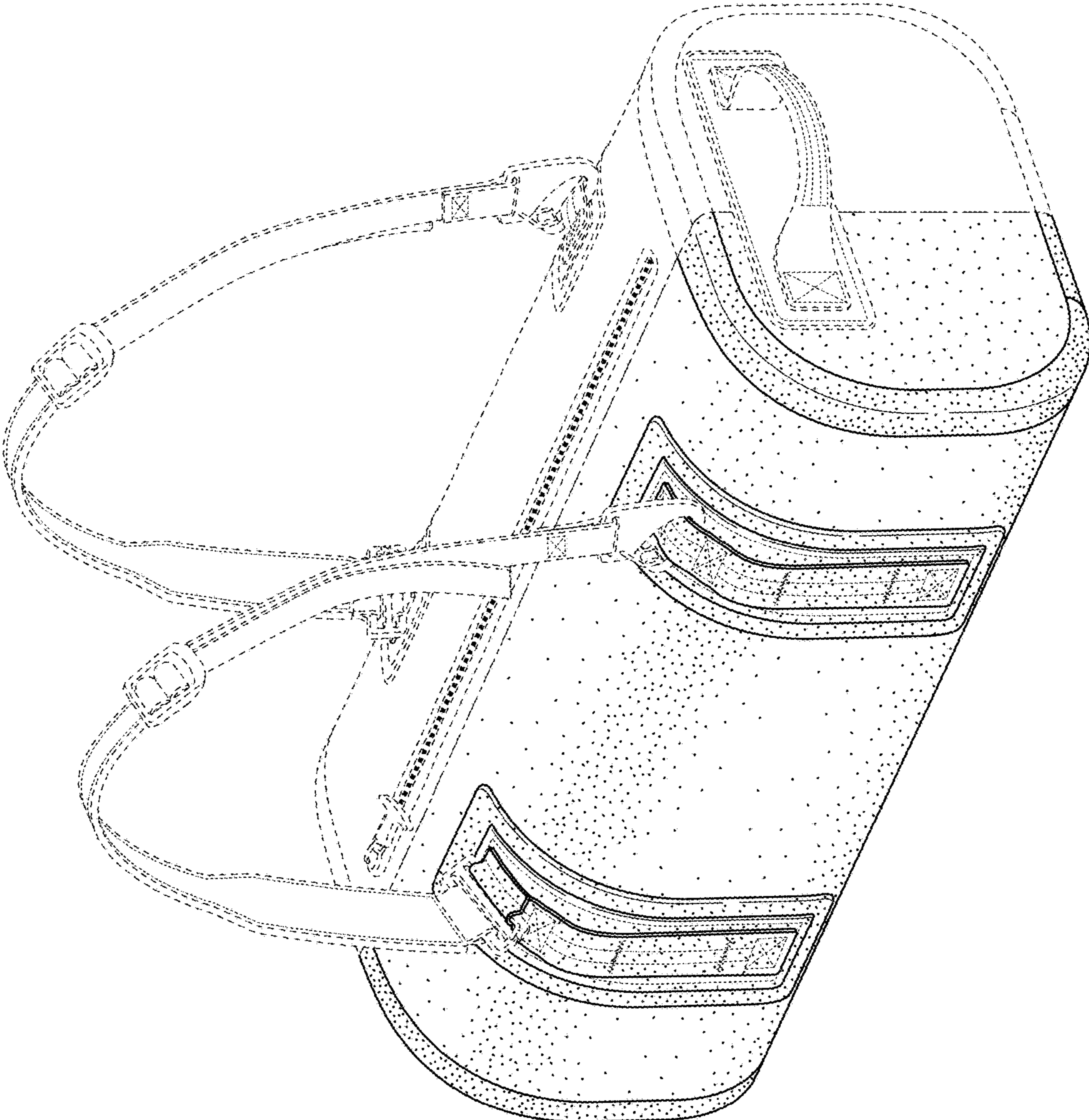

FIG. 1

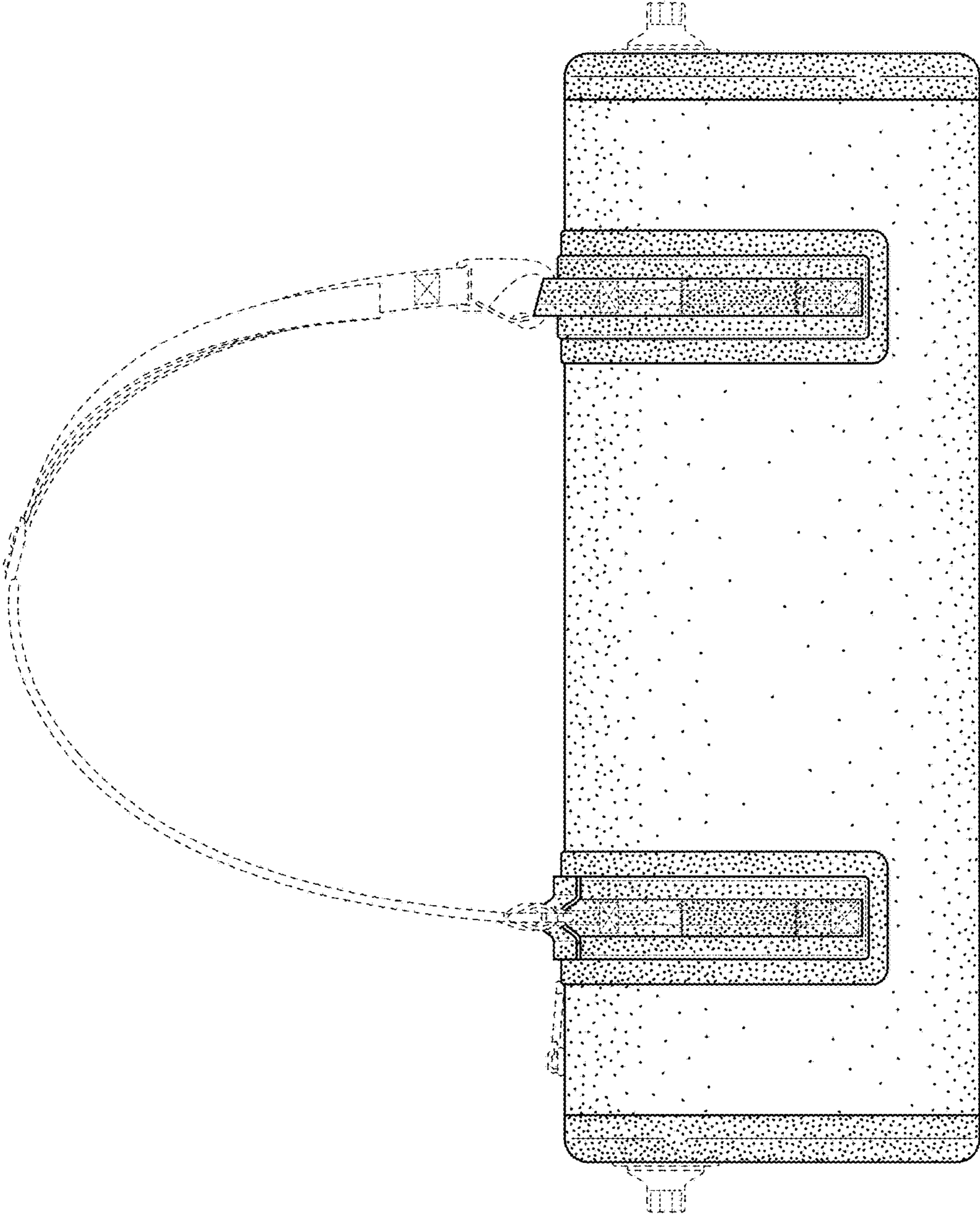

FIG. 2

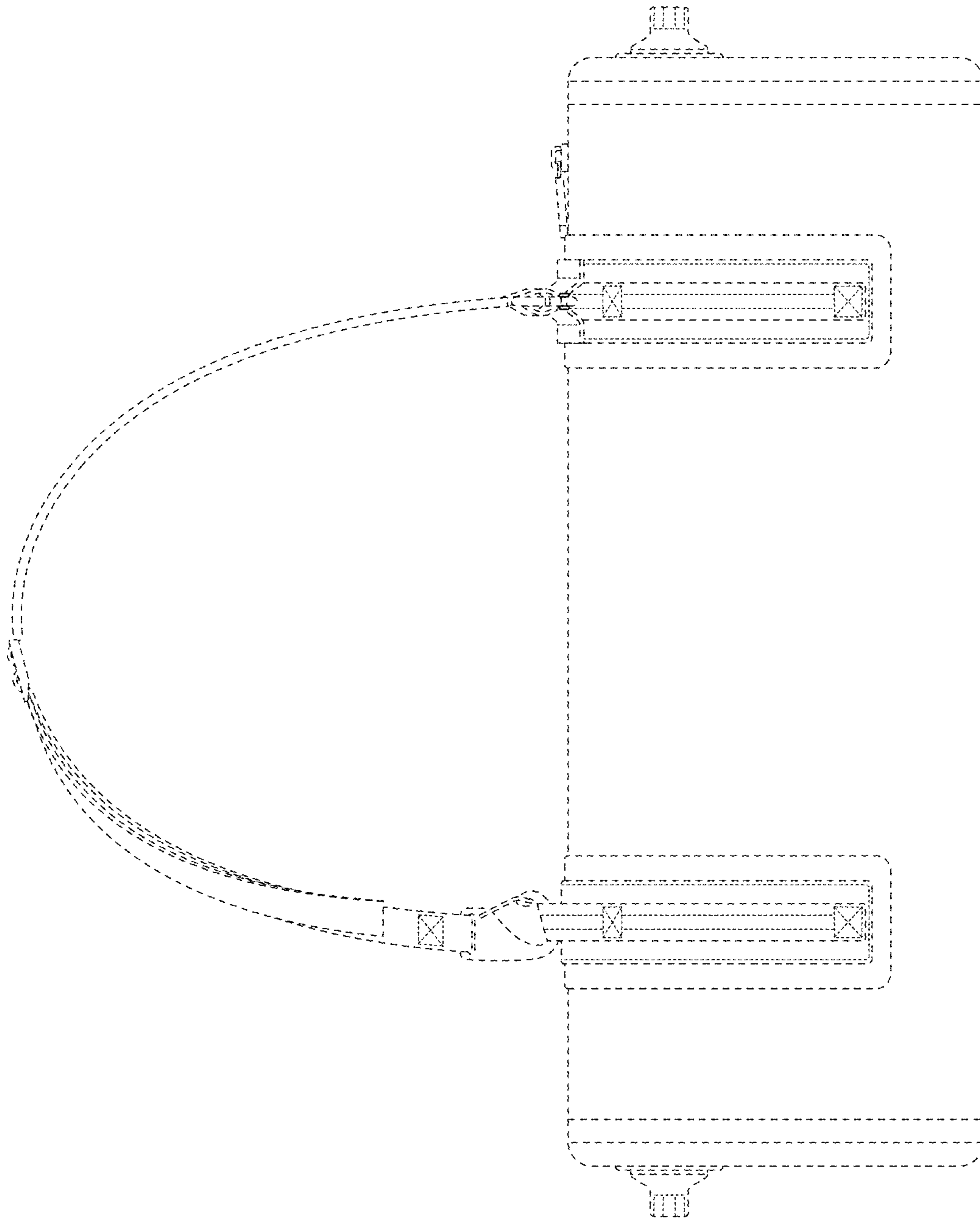

FIG. 3

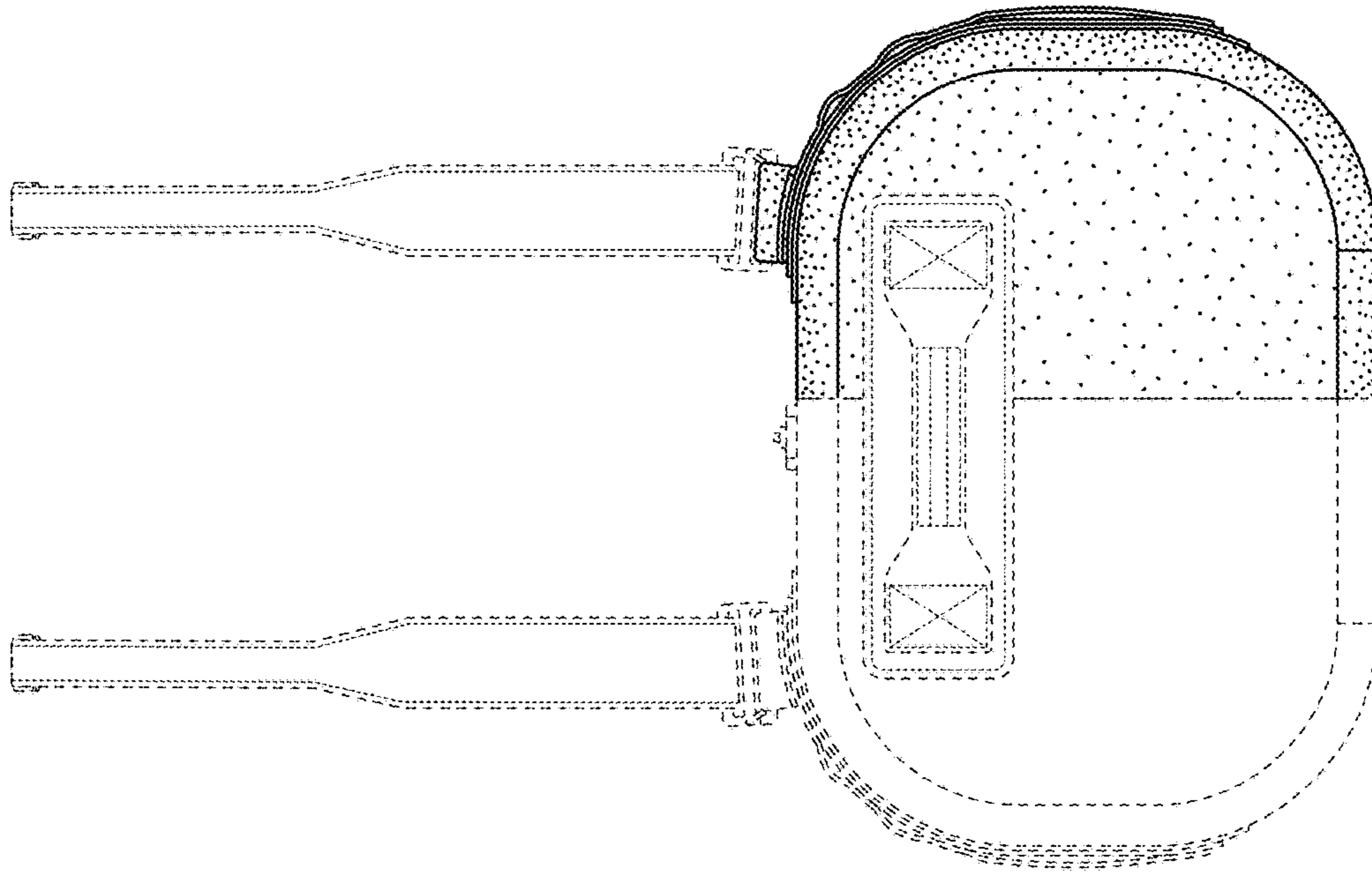

FIG. 5

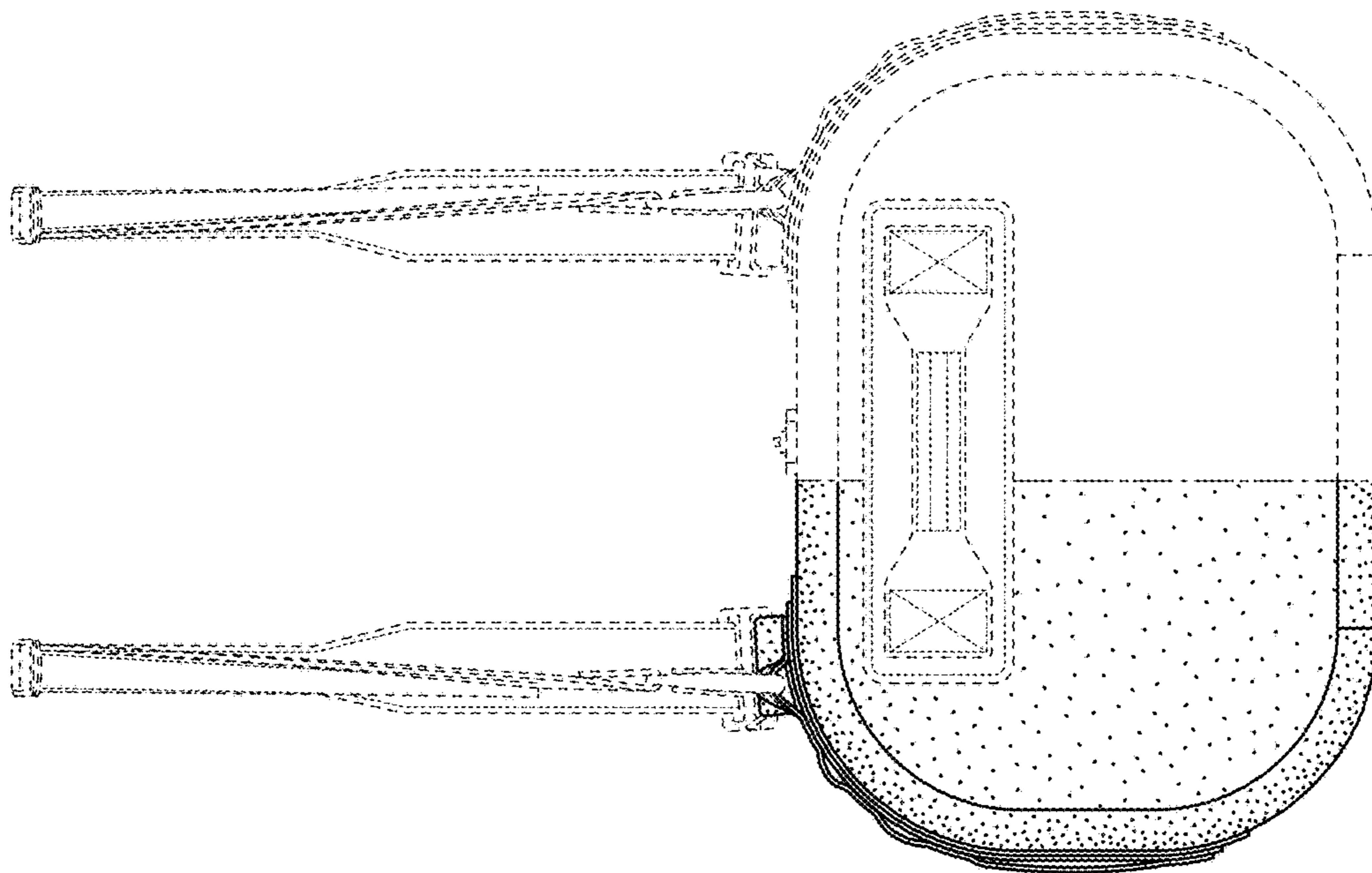

FIG. 4

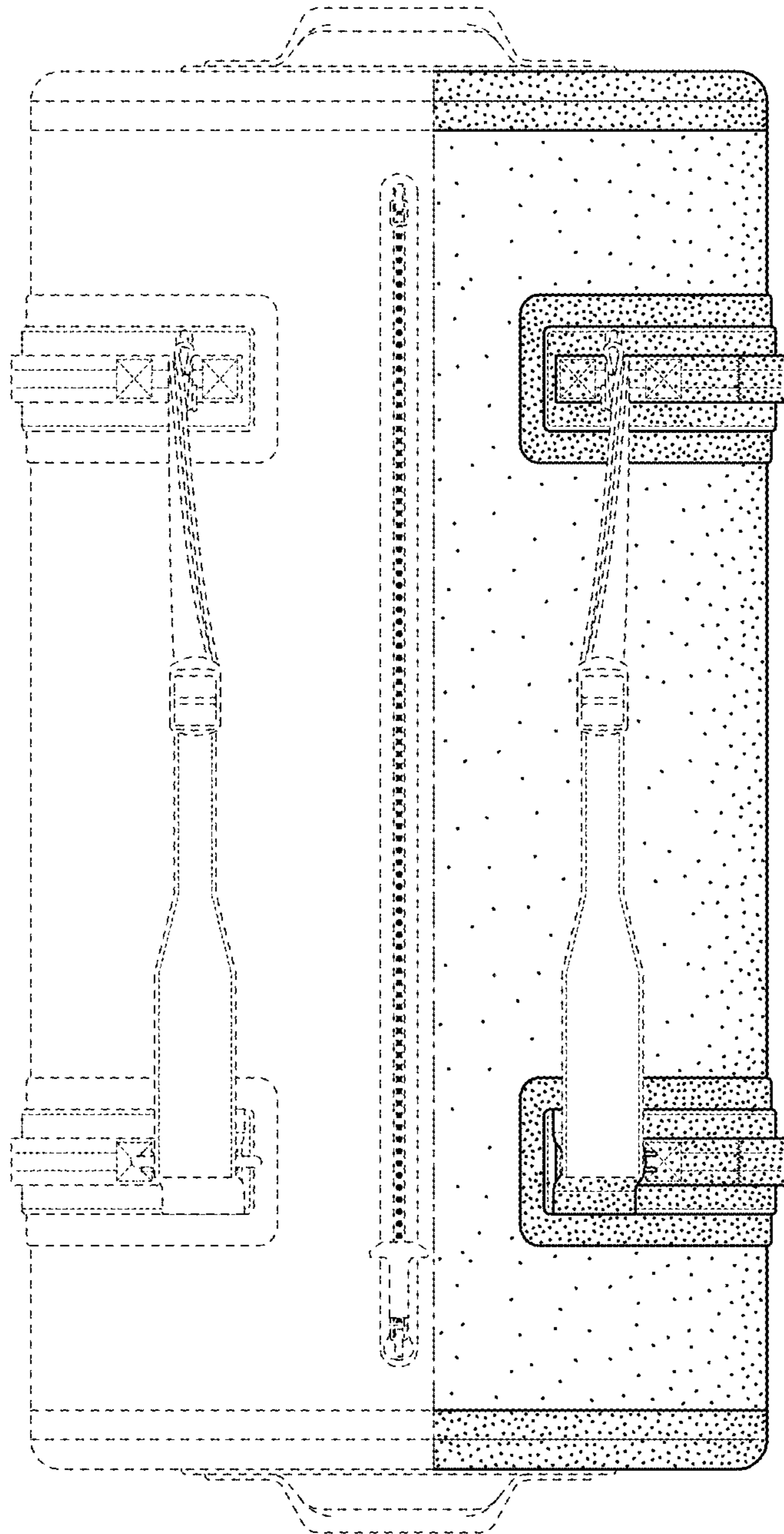

FIG. 6

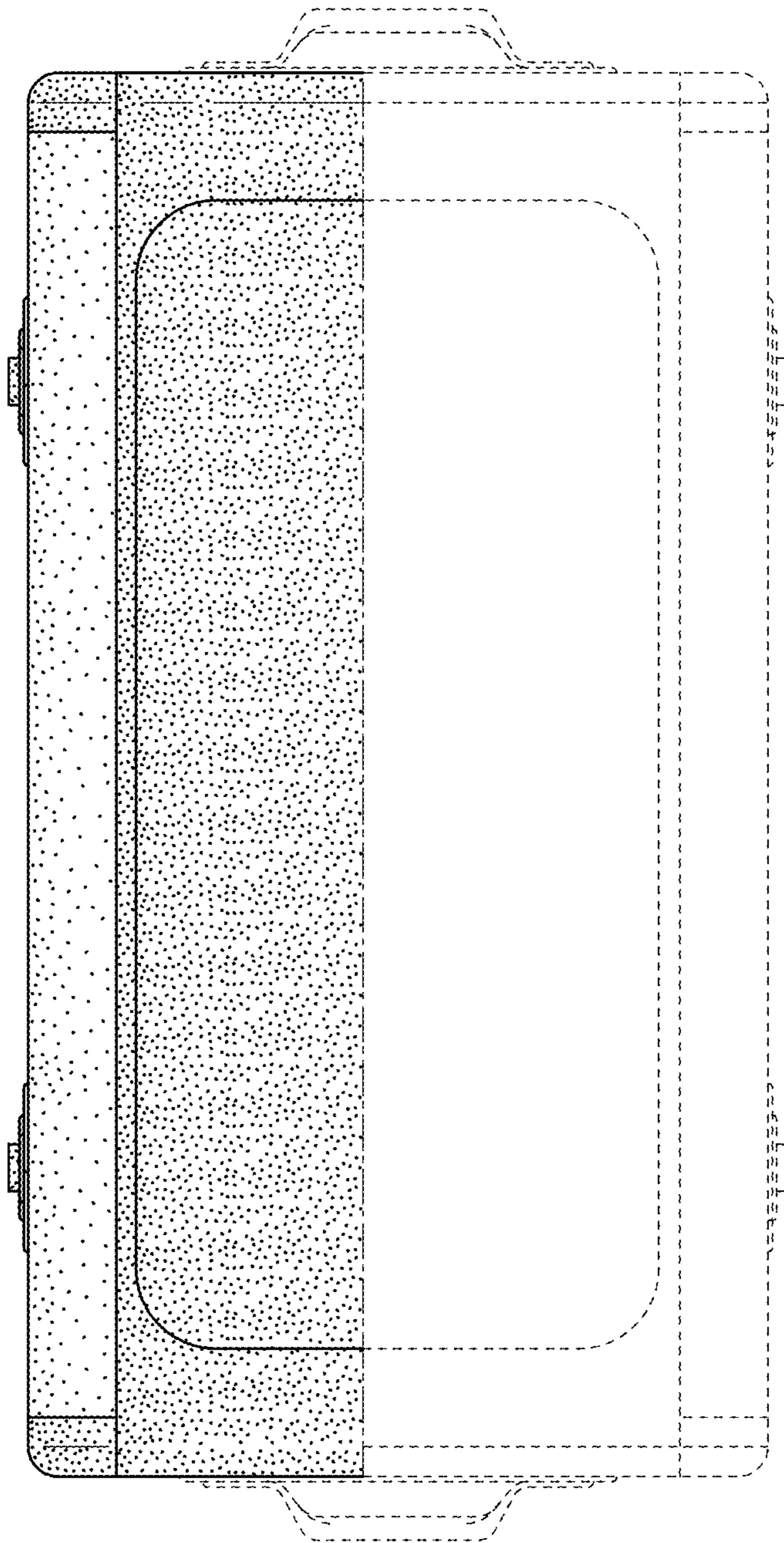

FIG. 7