



US00D808079S

(12) **United States Design Patent**
Diaz

(10) **Patent No.:** **US D808,079 S**
(45) **Date of Patent:** **** Jan. 16, 2018**

(54) **LIQUID SOAP HOLDING BODY WASHER**

D578,709 S * 10/2008 Schulte D21/599
D620,202 S * 7/2010 Chen D28/63
D726,375 S * 4/2015 Huang D28/63
2002/0166189 A1 * 11/2002 Huang A47K 7/028
15/209.1

(71) Applicant: **Victor Diaz**, Perris, CA (US)

(72) Inventor: **Victor Diaz**, Perris, CA (US)

(**) Term: **15 Years**

(21) Appl. No.: **29/583,453**

(22) Filed: **Nov. 4, 2016**

(51) **LOC (11) Cl.** **28-03**

(52) **U.S. Cl.**
USPC **D28/63**

(58) **Field of Classification Search**
USPC D4/127, 128, 130, 136, 137; D28/7, 63,
D28/99; D29/113, 118, 119; D32/40
CPC A47K 7/02
See application file for complete search history.

(56) **References Cited**

U.S. PATENT DOCUMENTS

6,510,577 B1 * 1/2003 Borchers A47K 7/02
15/118
D554,816 S * 11/2007 Lee D28/63
D576,768 S * 9/2008 Schulte D21/599
D578,253 S * 10/2008 Schulte D21/600

FOREIGN PATENT DOCUMENTS

EM 002006445-0004 * 3/2012

* cited by examiner

Primary Examiner — Karen E Eldridge Powers
(74) *Attorney, Agent, or Firm* — RG Patent Consulting,
LLC; Rachel Gilboy

(57) **CLAIM**

The ornamental design for a liquid soap holding body washer, as shown and described.

DESCRIPTION

FIG. 1 is a perspective view of the liquid soap holding body washer showing my new design;
FIG. 2 is a front elevation view thereof;
FIG. 3 is a rear elevation view thereof;
FIG. 4 is a right elevation view thereof;
FIG. 5 is a left elevation view thereof;
FIG. 6 is a top plan view thereof; and,
FIG. 7 is a bottom plan view thereof.

1 Claim, 7 Drawing Sheets

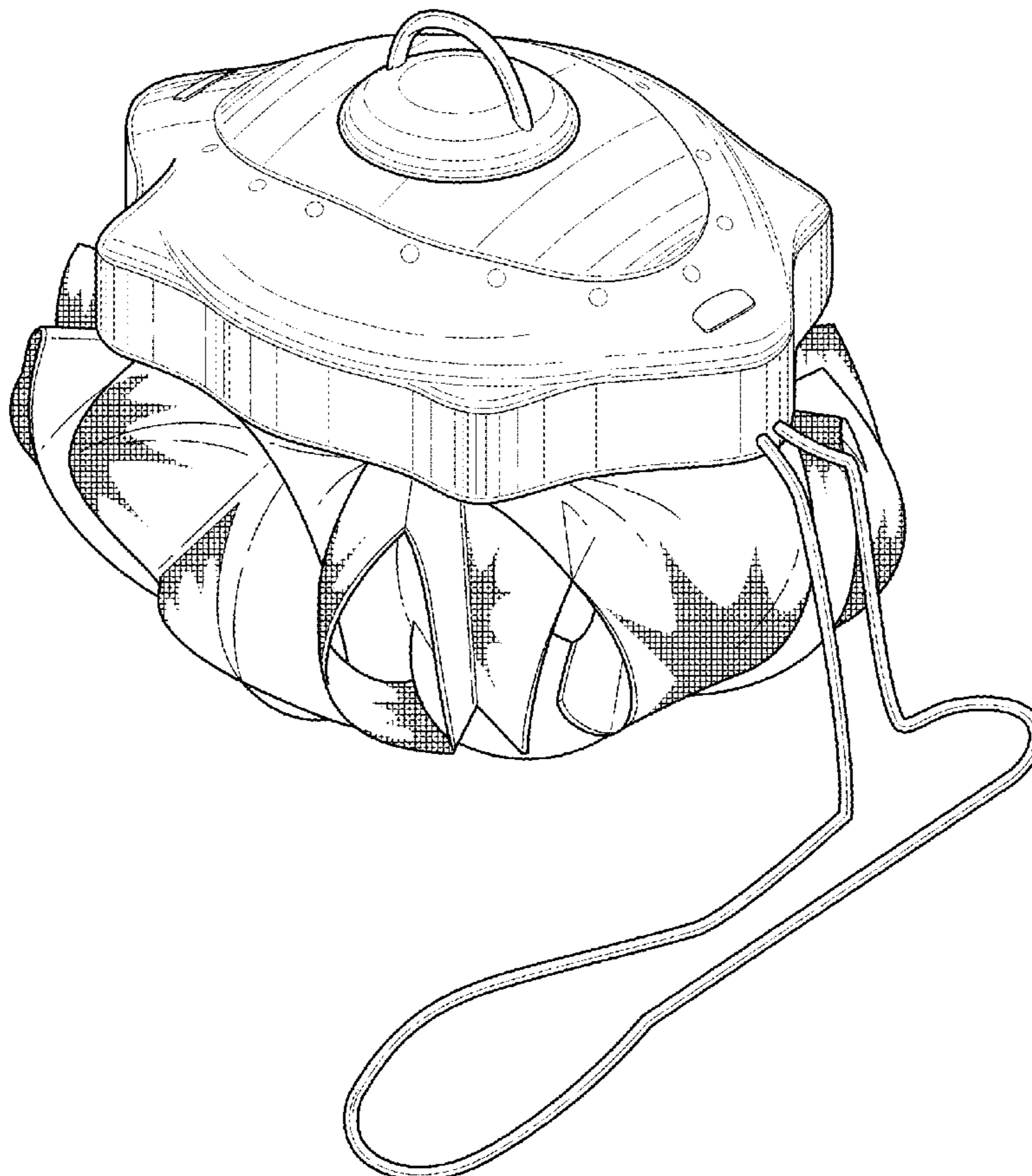

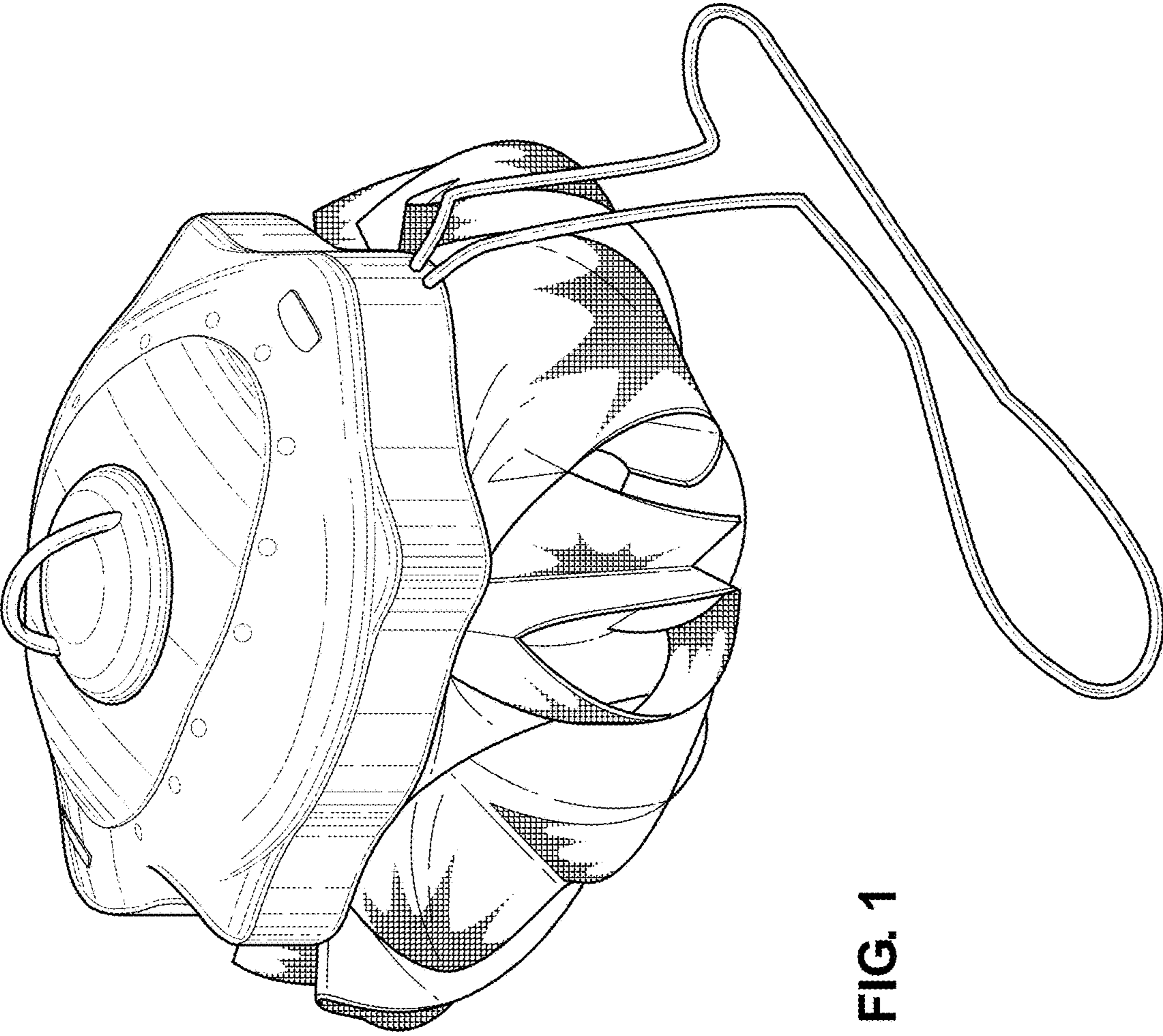

FIG. 1

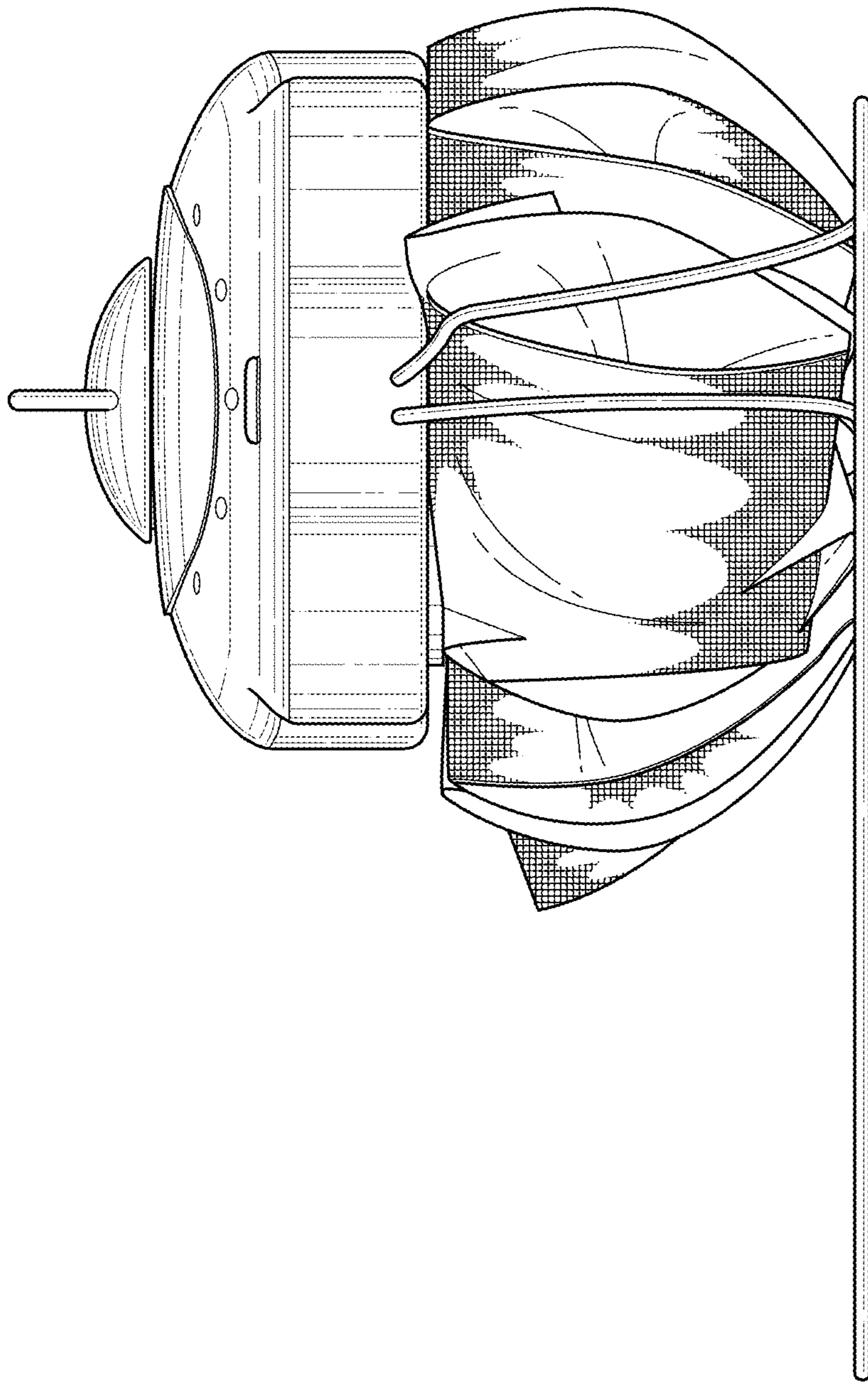

FIG. 2

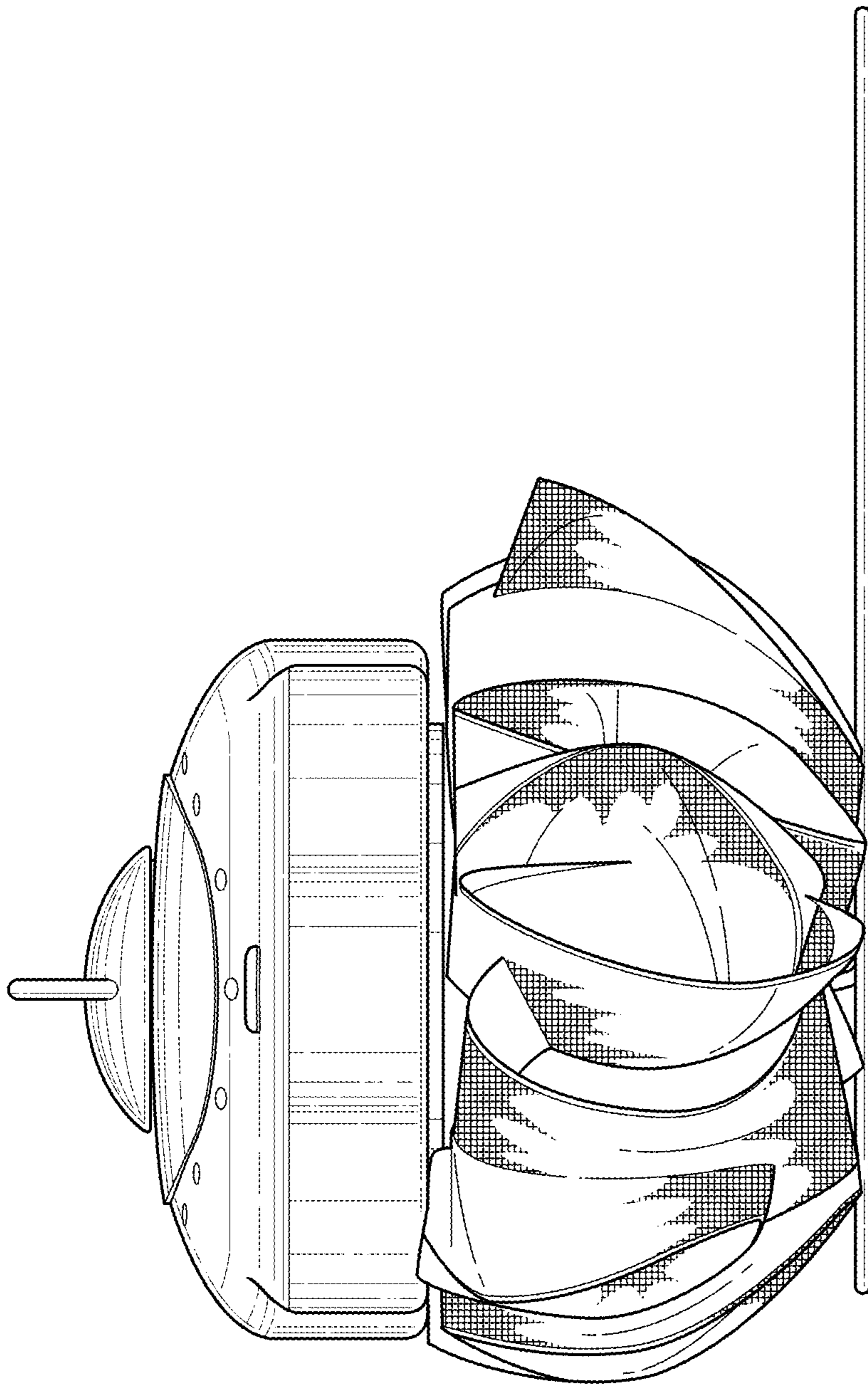

FIG. 3

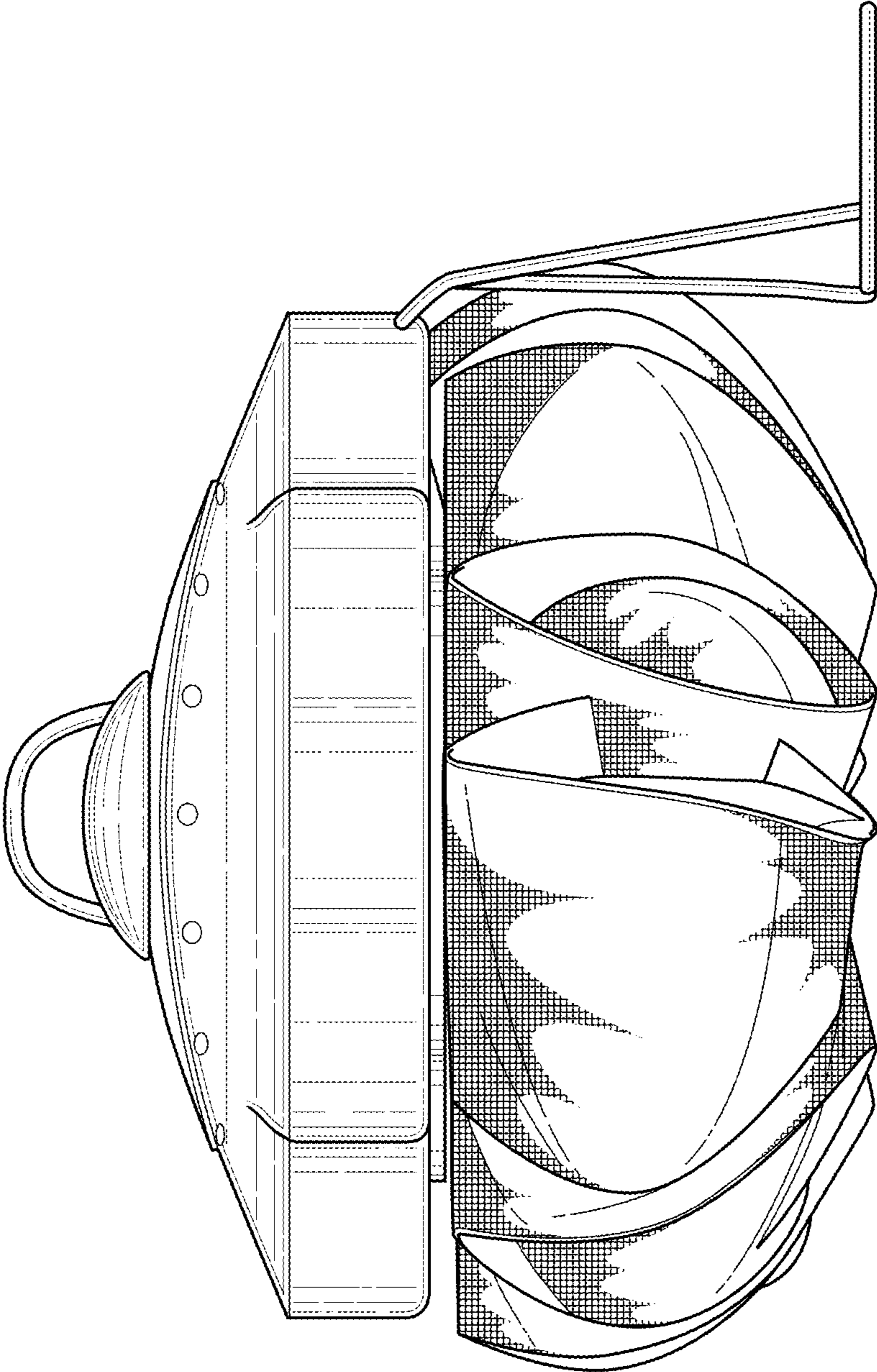

FIG. 4

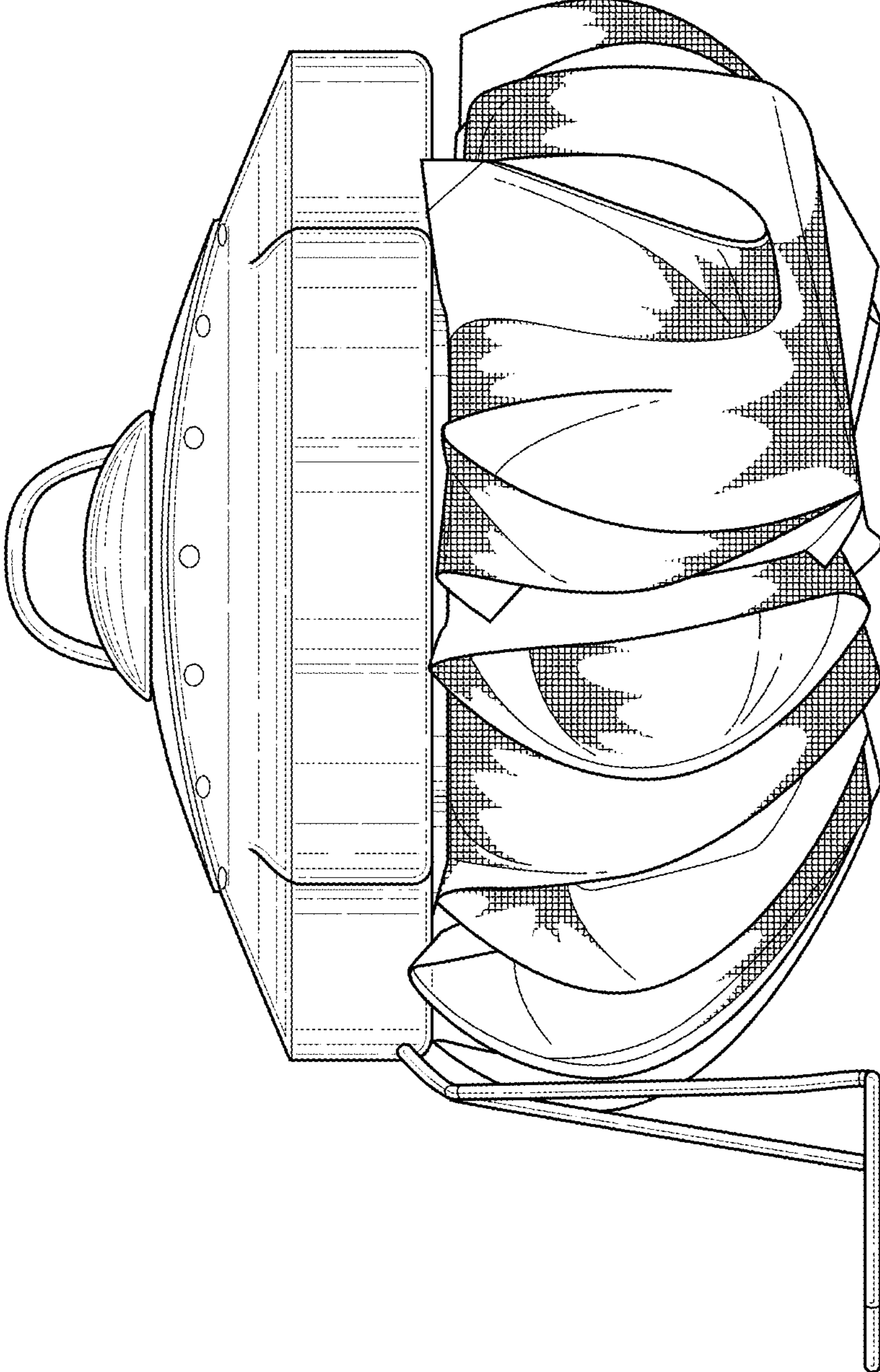

FIG. 5

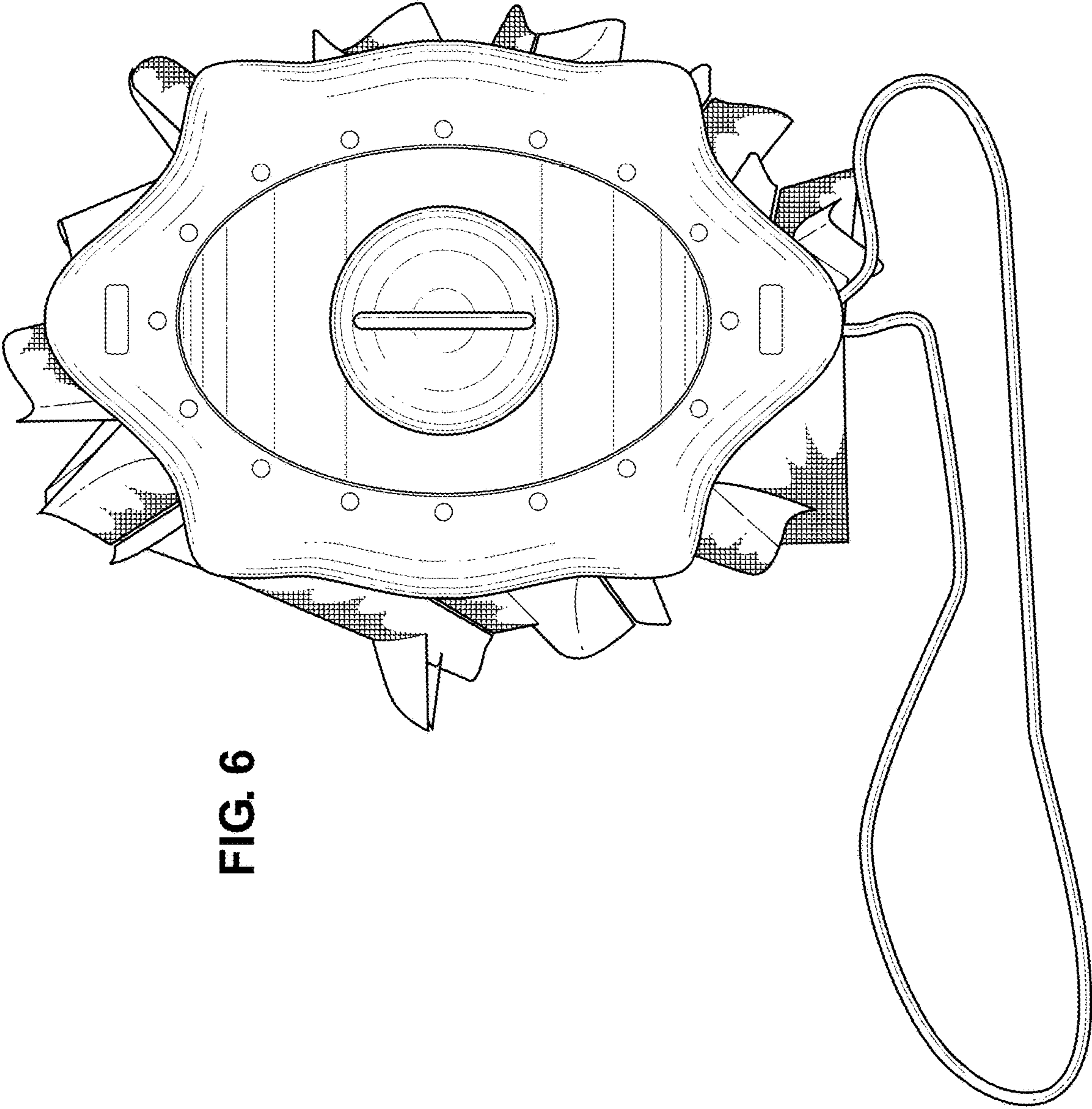

FIG. 6

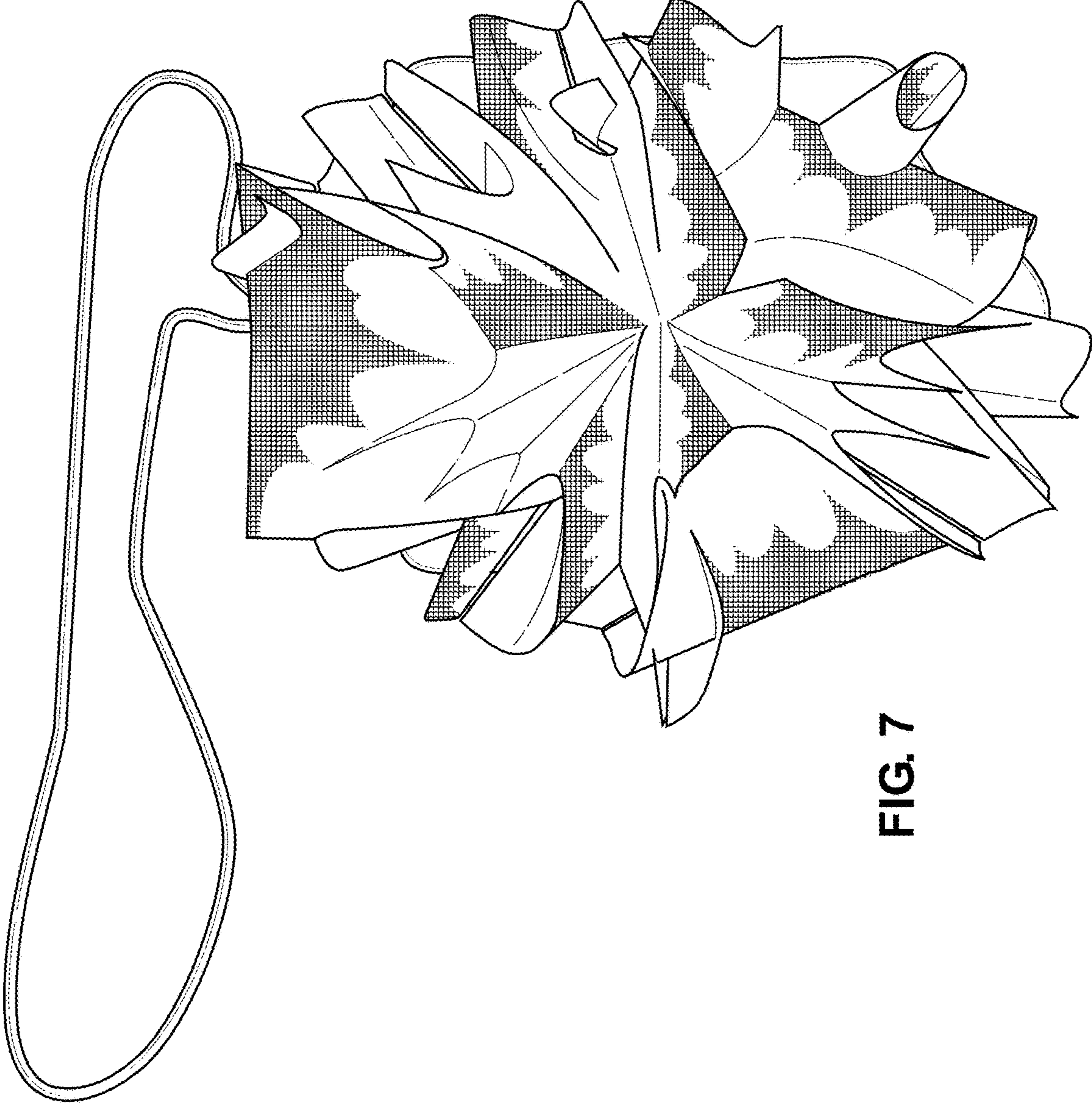

FIG. 7