



US00D808042S

(12) **United States Design Patent**
Lanzafame

(10) **Patent No.:** **US D808,042 S**
(45) **Date of Patent:** **** Jan. 16, 2018**

- (54) **ADJUSTABLE LADDER EXTENSION**
- (71) Applicant: **Philip F. Lanzafame**, Poulsbo, WA (US)
- (72) Inventor: **Philip F. Lanzafame**, Poulsbo, WA (US)
- (73) Assignee: **Phillip F. Lanzafame**, Poulsbo, WA (US)
- (**) Term: **15 Years**
- (21) Appl. No.: **29/576,870**
- (22) Filed: **Sep. 7, 2016**
- (51) **LOC (11) Cl.** **25-04**
- (52) **U.S. Cl.**
USPC **D25/68**
- (58) **Field of Classification Search**
USPC D25/62, 68; 182/107, 108, 109, 111, 182/201, 202, 203, 207, 208, 209, 210, 182/211, 212, 213
CPC E06C 7/06; E06C 7/42; E06C 1/10; E06C 7/02
See application file for complete search history.

- D420,752 S * 2/2000 Hiscock D25/68
- D485,369 S * 1/2004 Ranagan D25/68
- D584,422 S * 1/2009 Dangrow D25/68
- 2008/0190697 A1 * 8/2008 Skurkis E06C 7/44
182/204
- 2011/0214946 A1 * 9/2011 Yeh E06C 7/44
182/201
- 2015/0233180 A1 * 8/2015 Lanzafame E06C 7/426
182/204

* cited by examiner

Primary Examiner — Cynthia Ramirez

Assistant Examiner — Michael Maharajh

(74) *Attorney, Agent, or Firm* — Tucker Ellis LLP; Carlos Garritano

(57) **CLAIM**

The ornamental design for an adjustable ladder extension, as shown and described.

DESCRIPTION

FIG. 1 is a perspective view of an adjustable ladder extension showing my new design;
 FIG. 2 is a rear view of the adjustable ladder extension illustrated in FIG. 1;
 FIG. 3 is a front view of the adjustable ladder extension illustrated in FIG. 1;
 FIG. 4 is a left side view of the adjustable ladder extension illustrated in FIG. 1;
 FIG. 5 is a right side view of the adjustable ladder extension illustrated in FIG. 1;
 FIG. 6 is a top view of the adjustable ladder extension illustrated in FIG. 1; and,
 FIG. 7 is a bottom view of the adjustable ladder extension illustrated in FIG. 1.
 Any broken lines shown are for illustrative purposes only and form no part of the claimed designed.

1 Claim, 7 Drawing Sheets

(56) **References Cited**

U.S. PATENT DOCUMENTS

- 5,107,958 A * 4/1992 Johnson E06C 7/44
182/109
- 5,307,900 A * 5/1994 Noga E06C 7/44
182/111
- D364,930 S * 12/1995 Burge D25/68
- D380,277 S * 6/1997 Bonn D25/68
- 5,758,745 A * 6/1998 Beggs E06C 1/12
182/207
- 5,913,382 A * 6/1999 Martin E06C 7/44
182/107

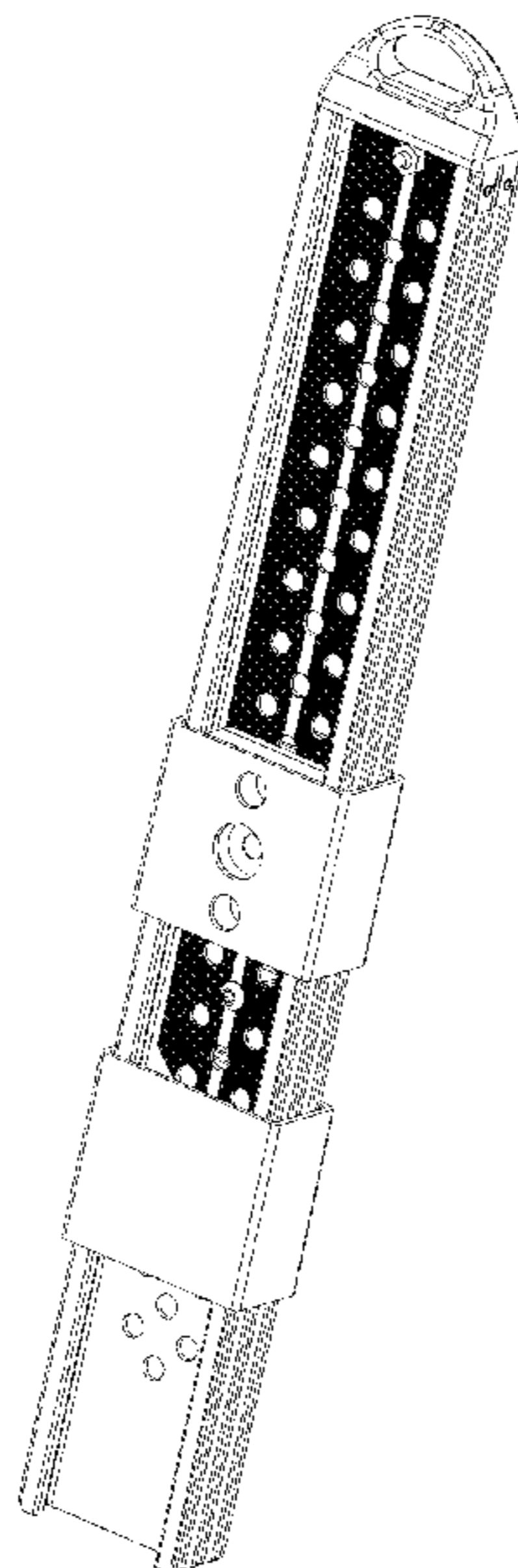

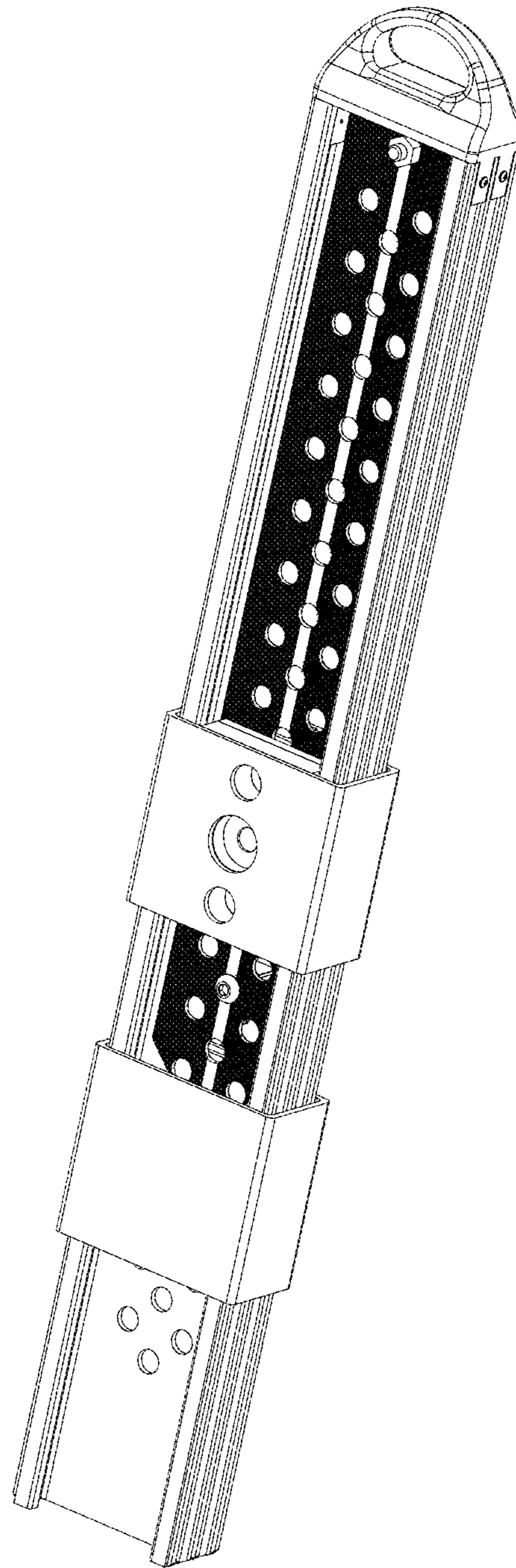

FIG. 1

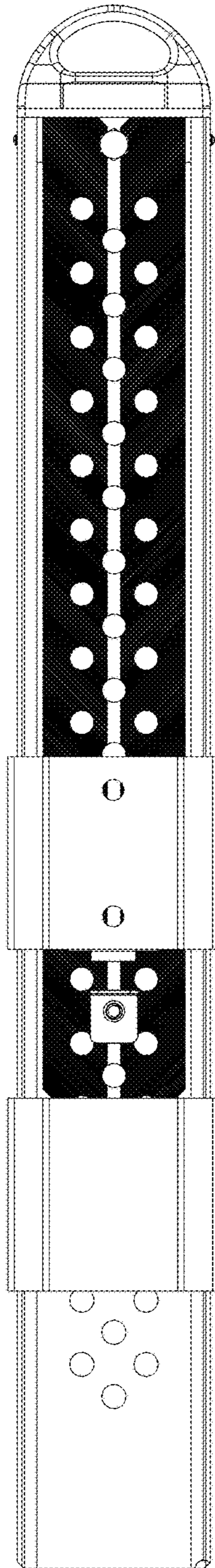

FIG. 2

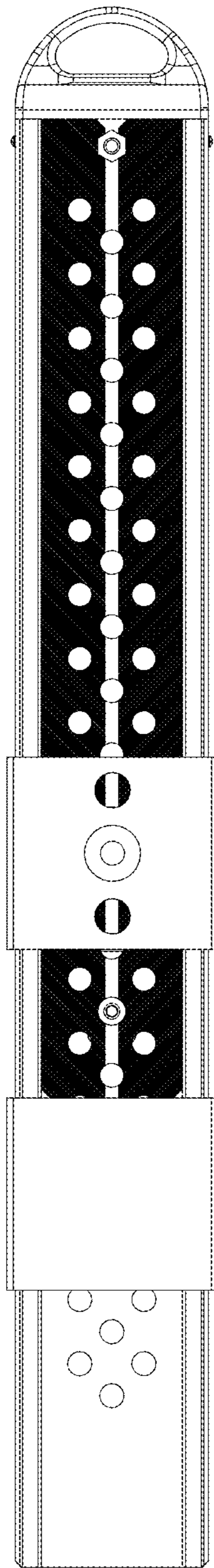

FIG. 3

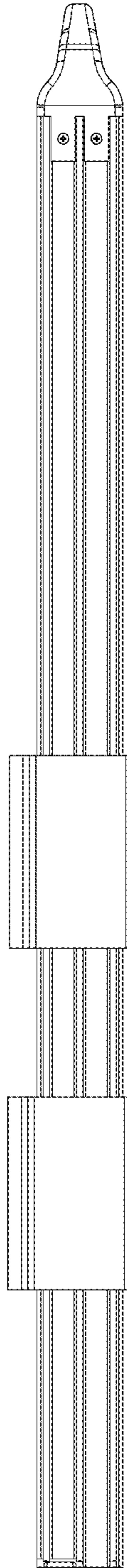

FIG. 4

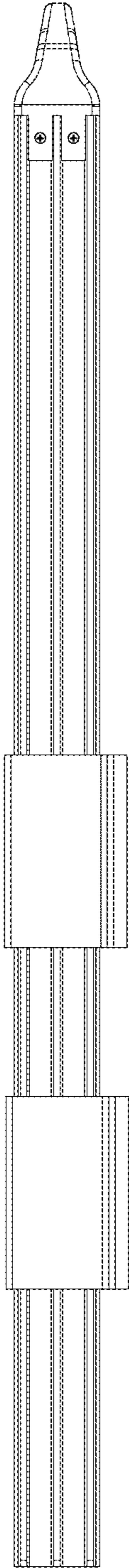

FIG. 5

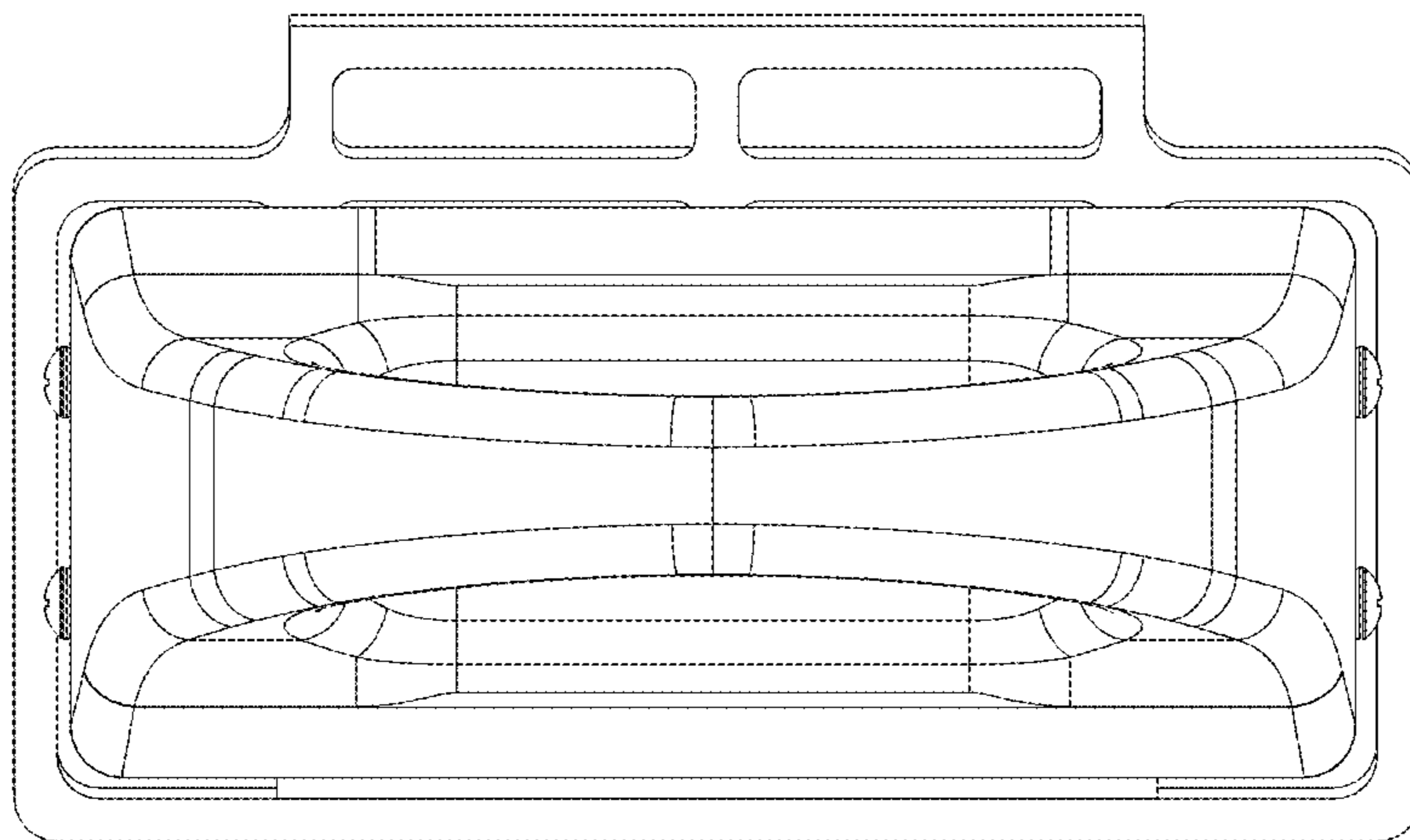

FIG. 6

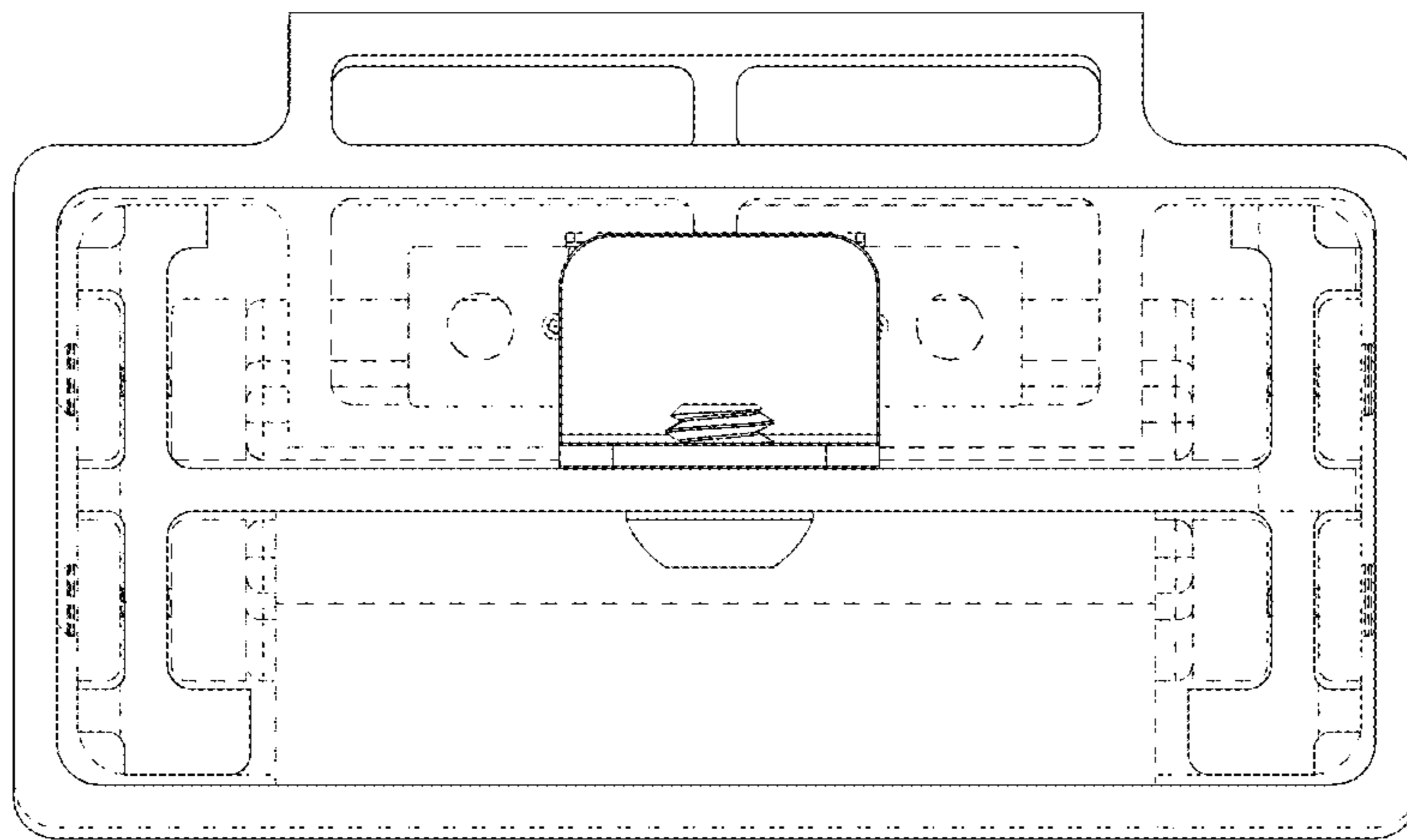

FIG. 7