



US00D807999S

(12) **United States Design Patent**  
**Schuller et al.**

(10) **Patent No.:** **US D807,999 S**  
(45) **Date of Patent:** **\*\* Jan. 16, 2018**

(54) **CARTRIDGE**

- (71) Applicant: **The Procter & Gamble Company**, Cincinnati, OH (US)
- (72) Inventors: **David William Schuller**, Lebanon, OH (US); **Stephen Adam Hughett**, Westerville, OH (US); **Igor Ivanovich Zemskov**, Dublin, OH (US); **Rainer Bernhard Teufel**, Worthington, OH (US)
- (73) Assignee: **The Procter & Gamble Company**, Cincinnati, OH (US)

(\*\*) Term: **15 Years**

(21) Appl. No.: **29/539,629**

(22) Filed: **Sep. 16, 2015**

(51) **LOC (11) Cl.** ..... **28-99**

(52) **U.S. Cl.**  
USPC ..... **D23/366**

(58) **Field of Classification Search**  
USPC ..... D23/355-369; D28/5, 6; 261/DIG. 17, 261/DIG. 42, DIG. 47, DIG. 55, DIG. 65, 261/DIG. 70, DIG. 88, DIG. 89; 392/386, 392/389, 394, 395, 403; 239/34, 44, 45, 239/53, 56; D9/522, 549, 556; D8/399; D7/553.4, 553.8, 357; D11/222

(Continued)

(56) **References Cited**

**U.S. PATENT DOCUMENTS**

- D508,414 S \* 8/2005 Lamb ..... D9/504
- D520,877 S \* 5/2006 Toth ..... D9/522

(Continued)

**OTHER PUBLICATIONS**

U.S. Appl. No. 29/539,630, filed Sep. 16, 2015, Schuller, et al.

*Primary Examiner* — Sandra Snapp

(74) *Attorney, Agent, or Firm* — Abbey A. Lopez

(57) **CLAIM**

The ornamental design for a cartridge, as shown and described.

**DESCRIPTION**

FIG. 1 is a perspective view of a first embodiment of a cartridge;

FIG. 2 is a front elevation view of the cartridge of FIG. 1;

FIG. 3 is a right side elevation view of the cartridge of FIG. 1;

FIG. 4 is a back elevation view of the cartridge of FIG. 1;

FIG. 5 is a left side elevation view of the cartridge of FIG. 1;

FIG. 6 is a top plan view of the cartridge of FIG. 1;

FIG. 7 is a bottom plan view of the cartridge of FIG. 1;

FIG. 8 is a perspective view of a second embodiment of a cartridge;

FIG. 9 is a front elevation view of the cartridge of FIG. 8;

FIG. 10 is a right side elevation view of the cartridge of FIG. 8;

FIG. 11 is a back elevation view of the cartridge of FIG. 8;

FIG. 12 is a left side elevation view of the cartridge of FIG. 8;

FIG. 13 is a top plan view of the cartridge of FIG. 8; and,

FIG. 14 is a bottom plan view of the cartridge of FIG. 8.

The broken lines illustrating portions of the cartridge shown in the drawings are for illustrative purposes only and form no part of the claimed design.

The surfaces or portions not shown in the drawings or described in the specification form no part of the claimed design.

**1 Claim, 2 Drawing Sheets**

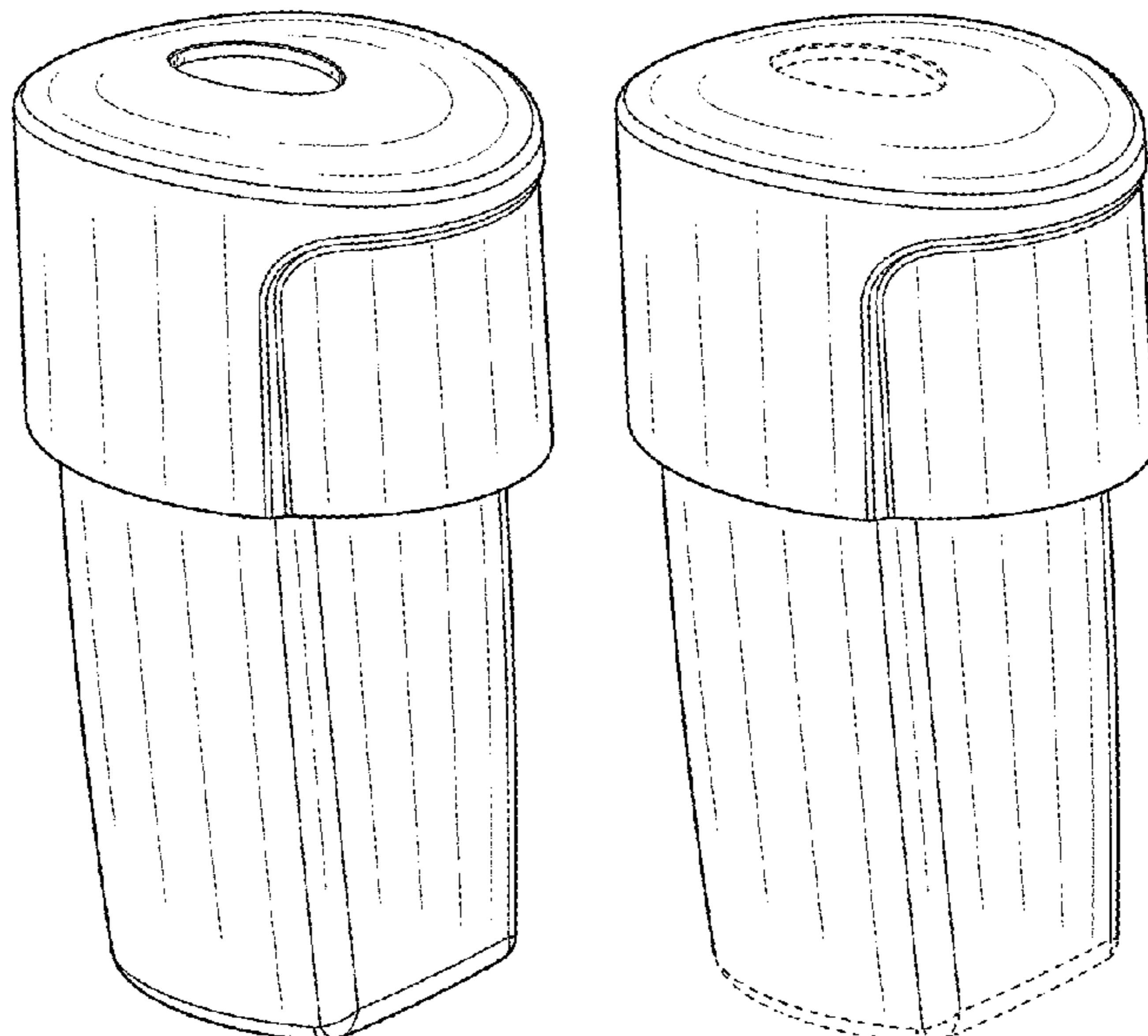

(58) **Field of Classification Search**

CPC ... A61L 9/02; A61L 9/03; A61L 9/034; A61L  
9/04; A61L 9/12; A61L 9/032; A61L  
9/122; A61L 9/127; A61L 9/22

See application file for complete search history.

(56) **References Cited**

U.S. PATENT DOCUMENTS

D535,564 S *	1/2007	Toth .....	D9/522
D564,884 S *	3/2008	Rittman .....	D9/452
D574,249 S *	8/2008	Seum .....	D9/529
D615,410 S *	5/2010	Lett .....	D9/435
D686,500 S *	7/2013	Weil .....	D9/522

\* cited by examiner

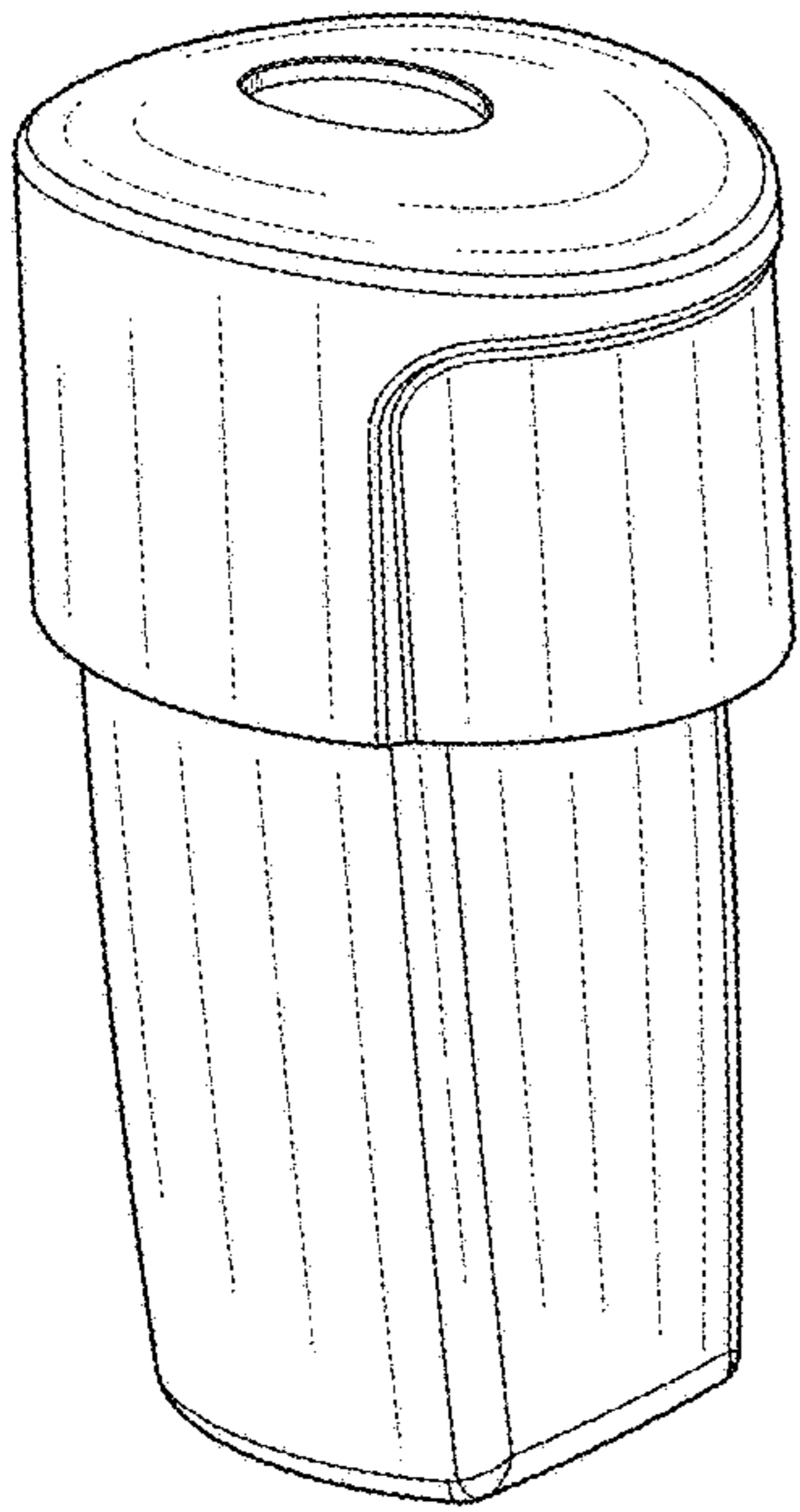

Fig. 1

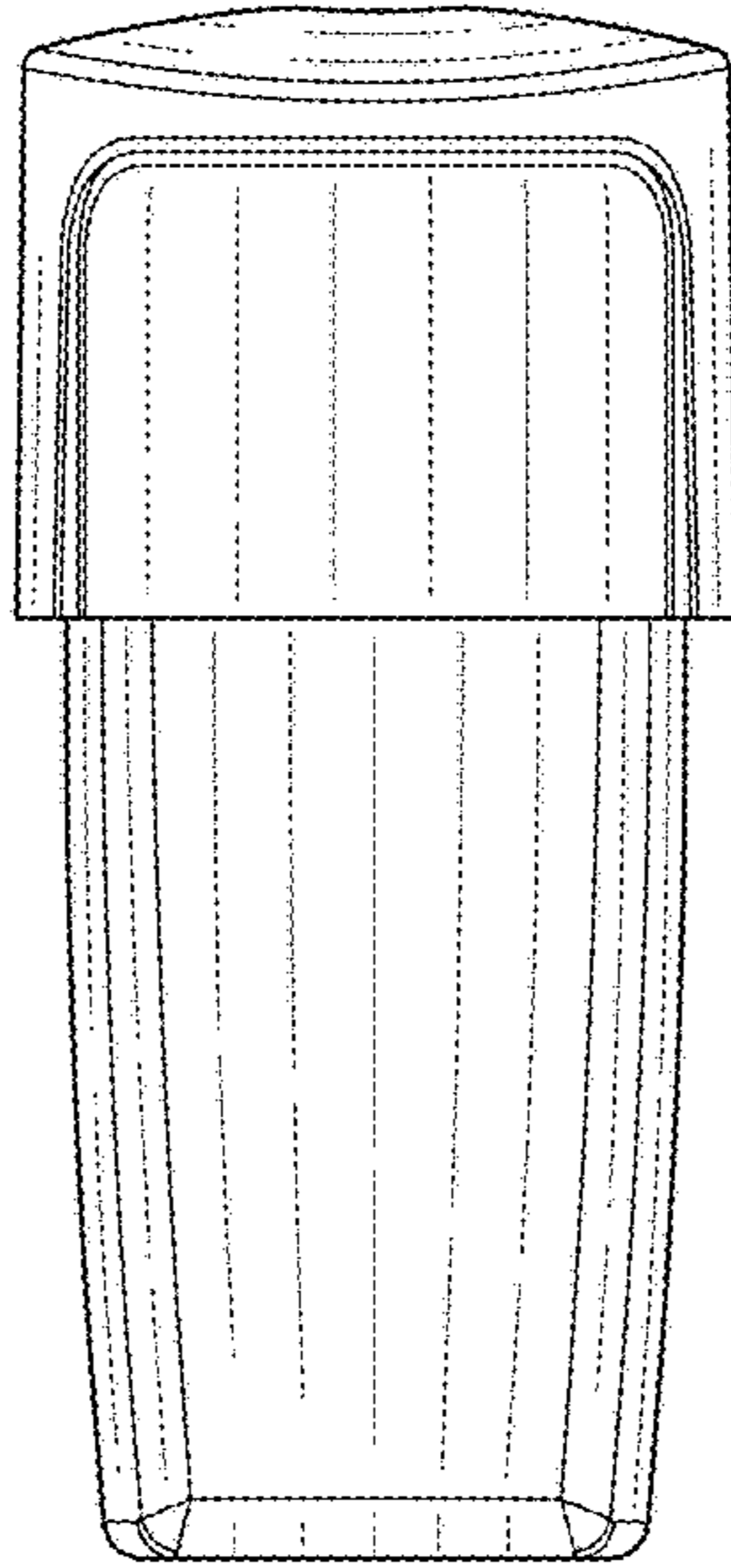

Fig. 2

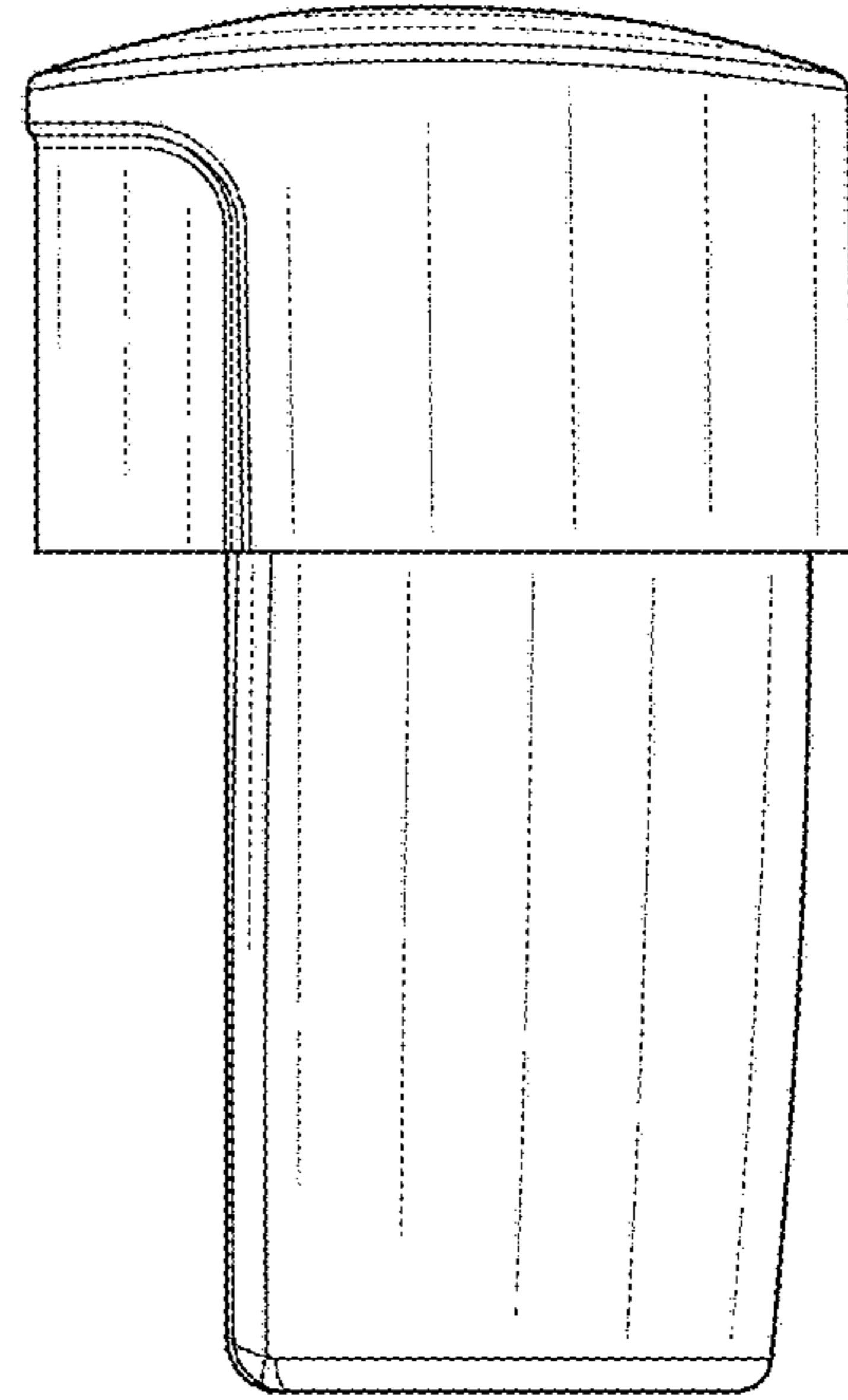

Fig. 3

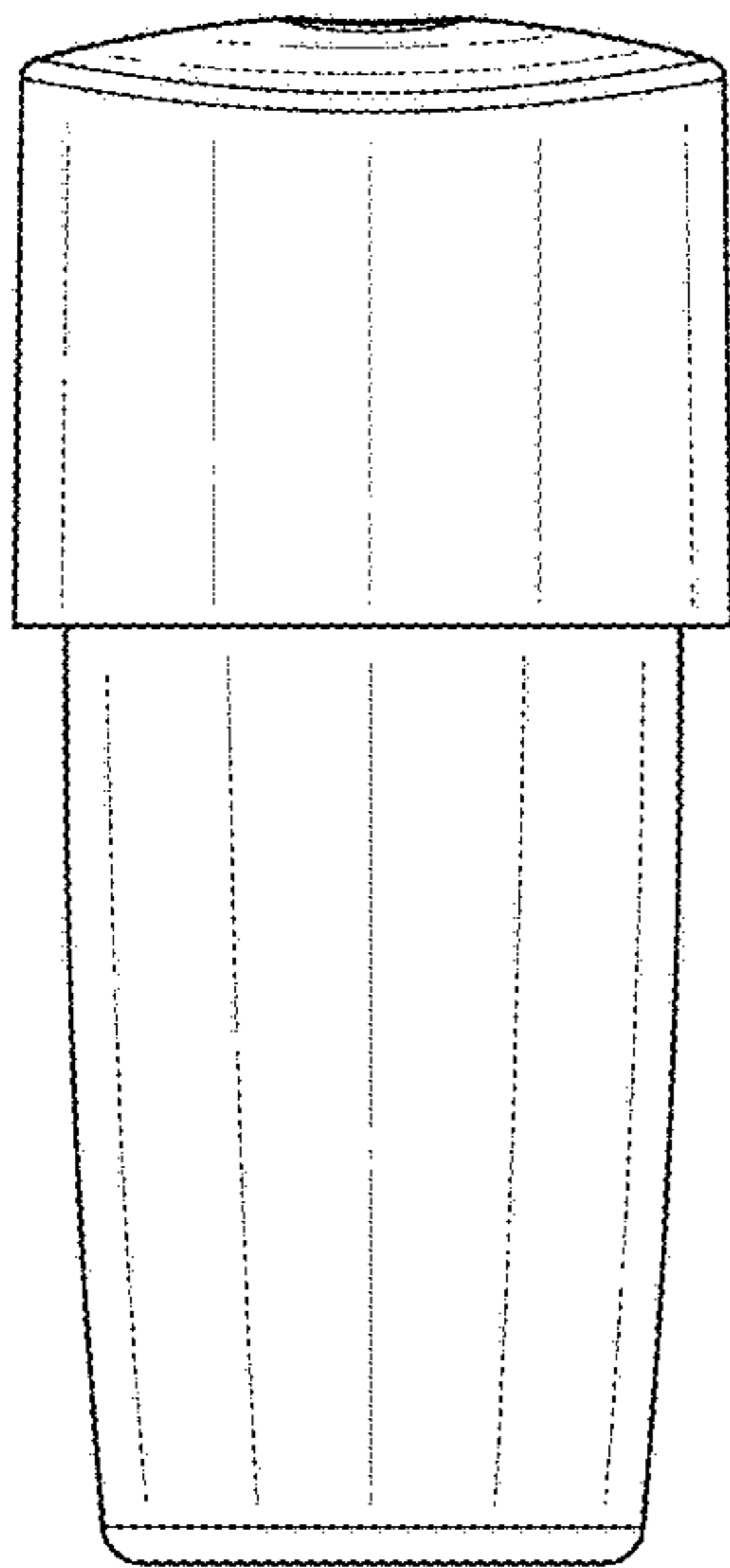

Fig. 4

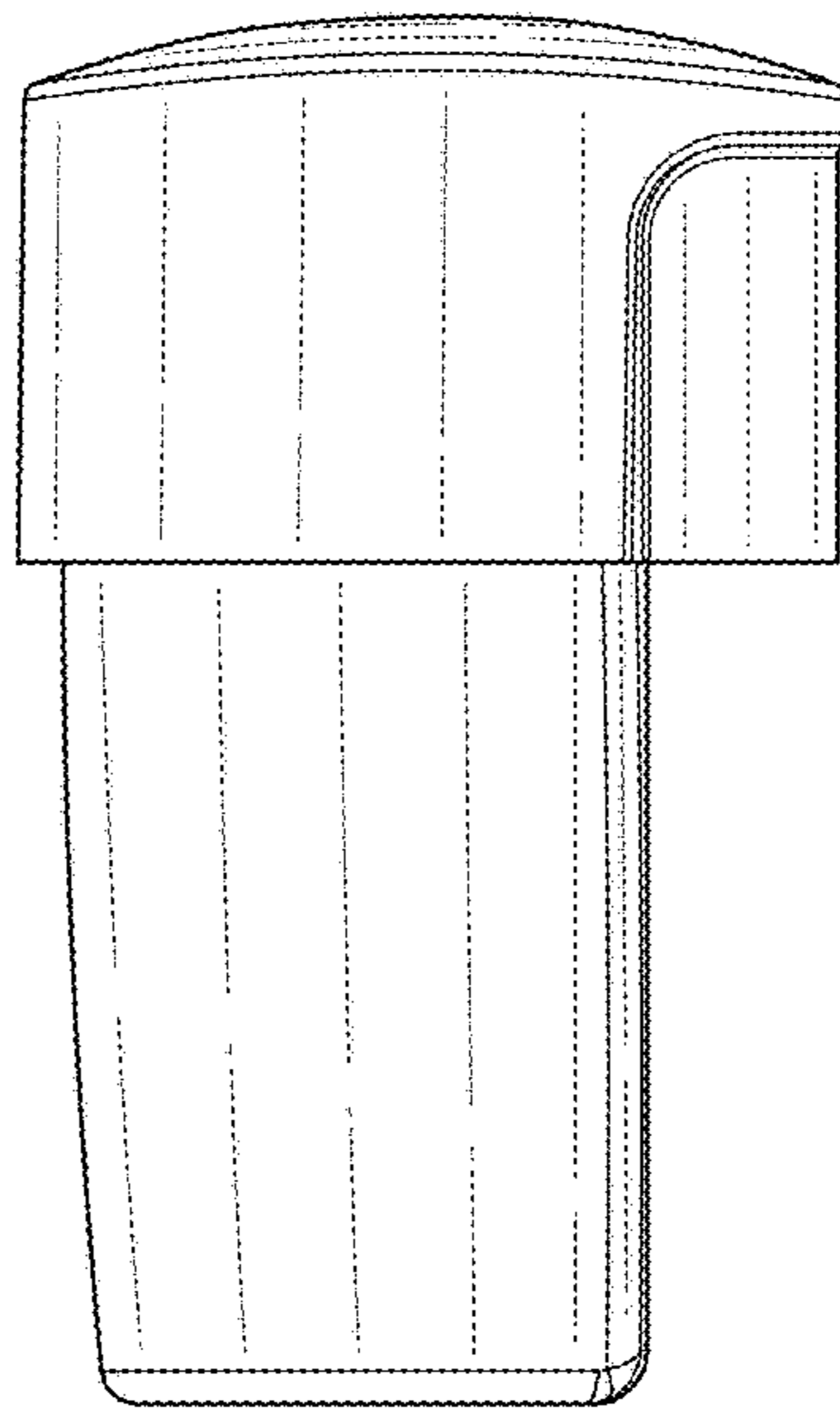

Fig. 5

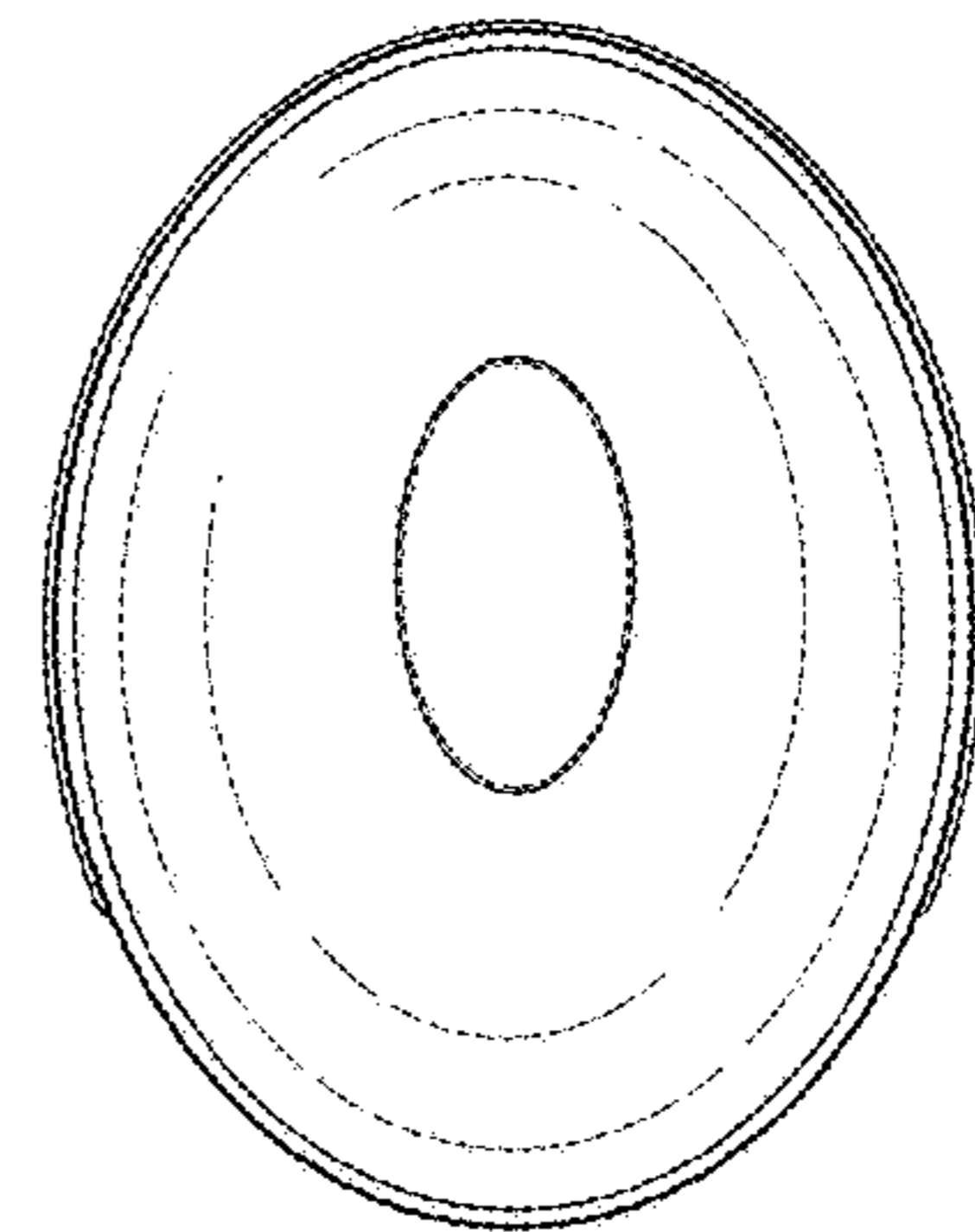

Fig. 6

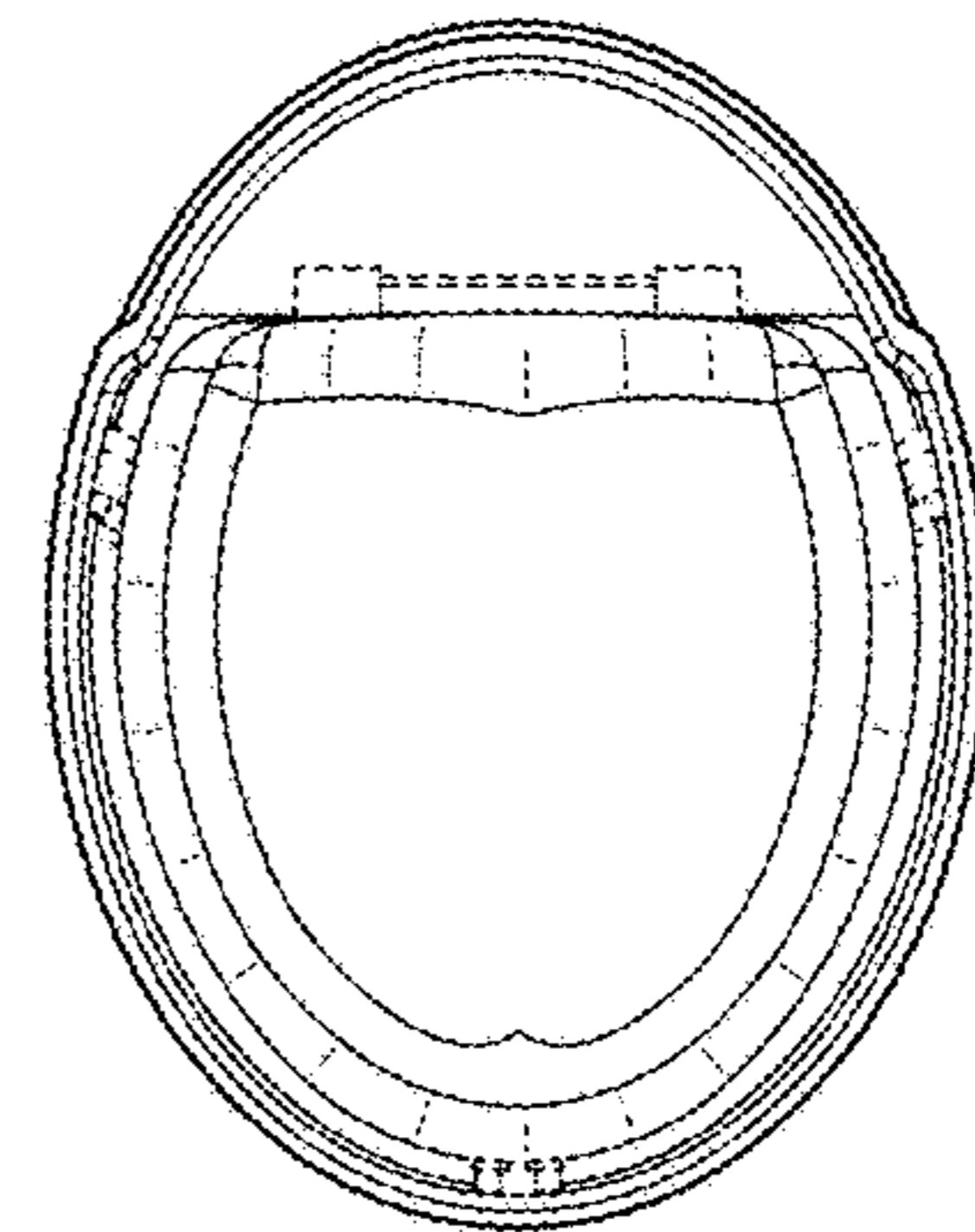

Fig. 7

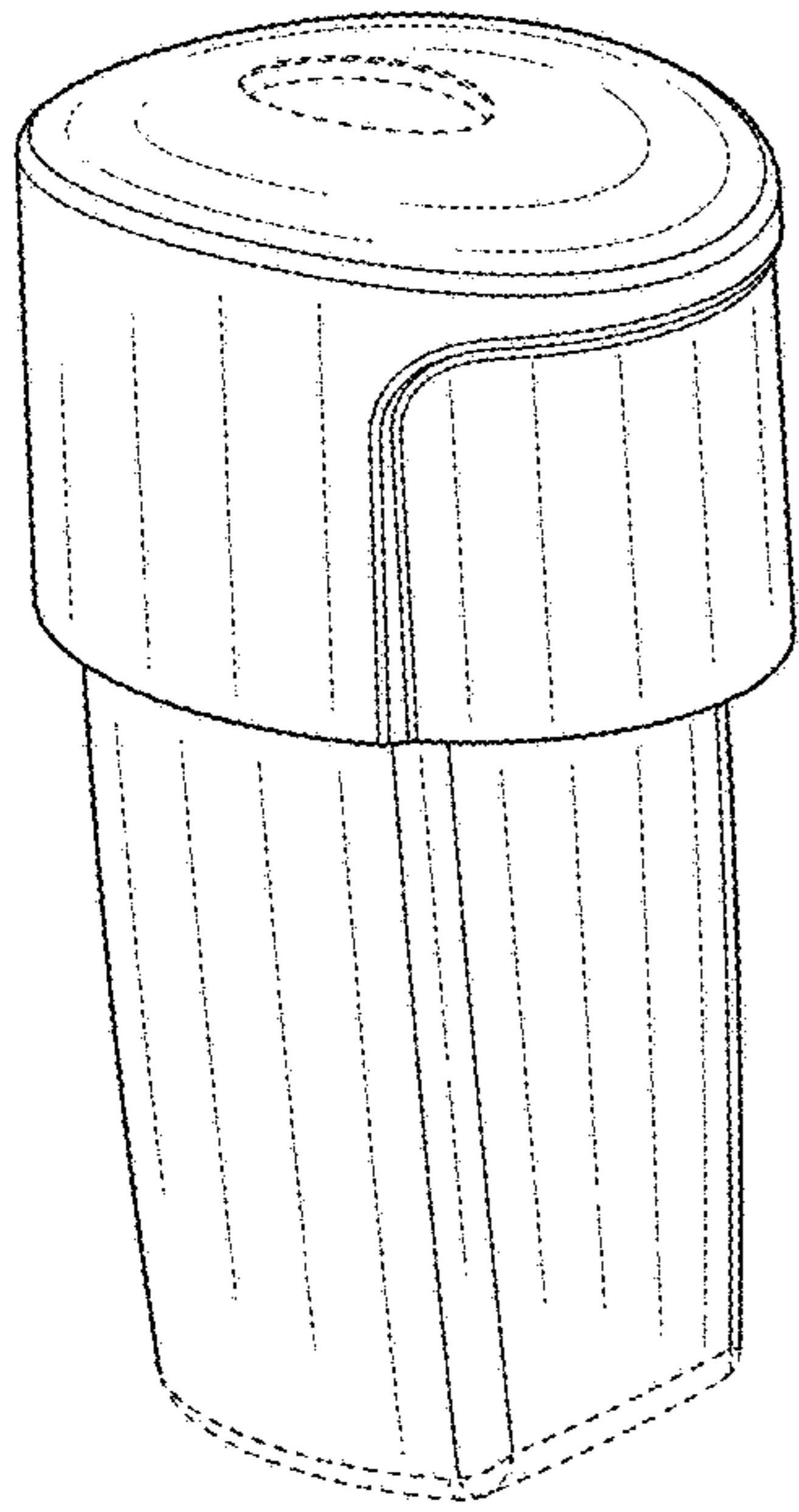

Fig. 8

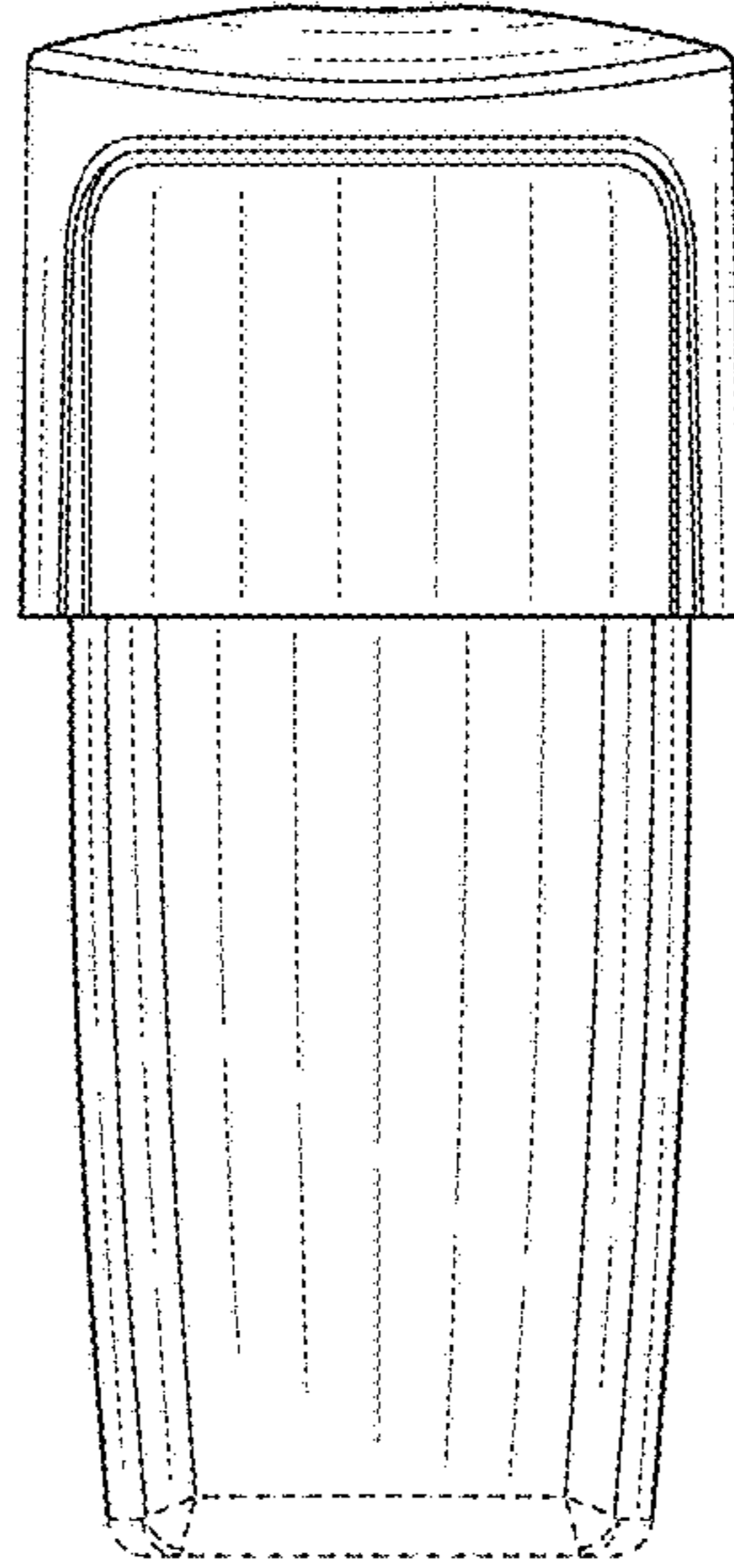

Fig. 9

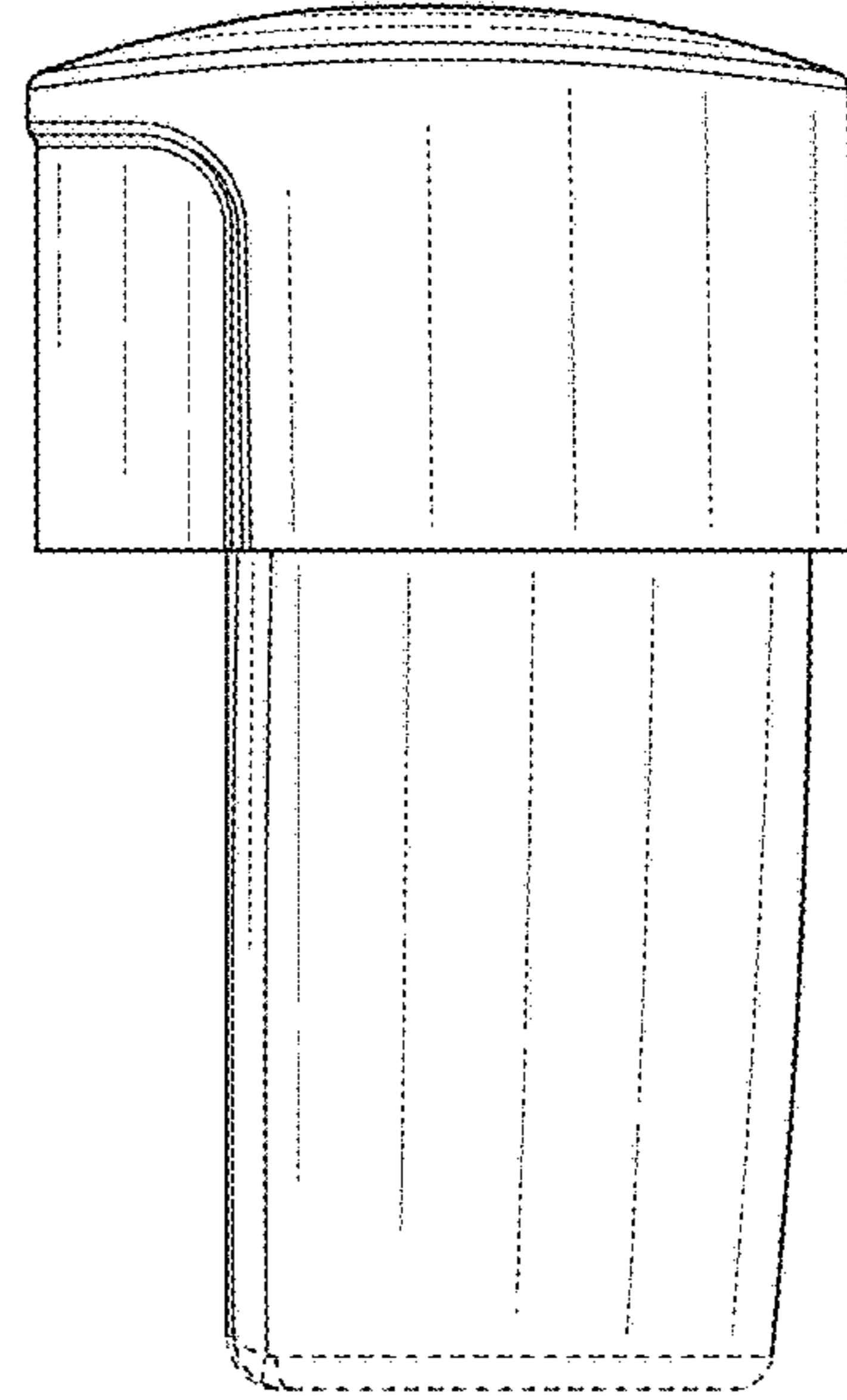

Fig. 10

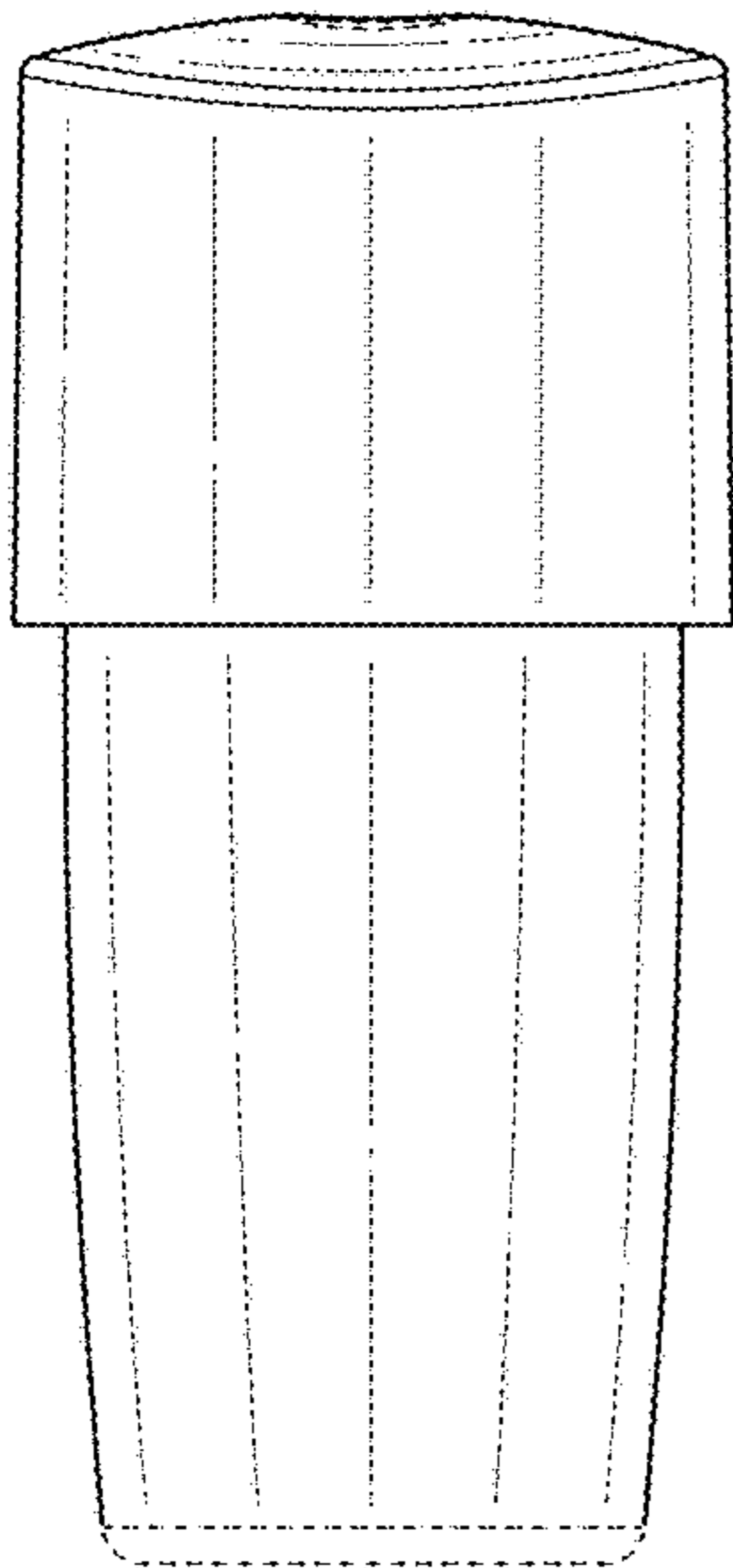

Fig. 11

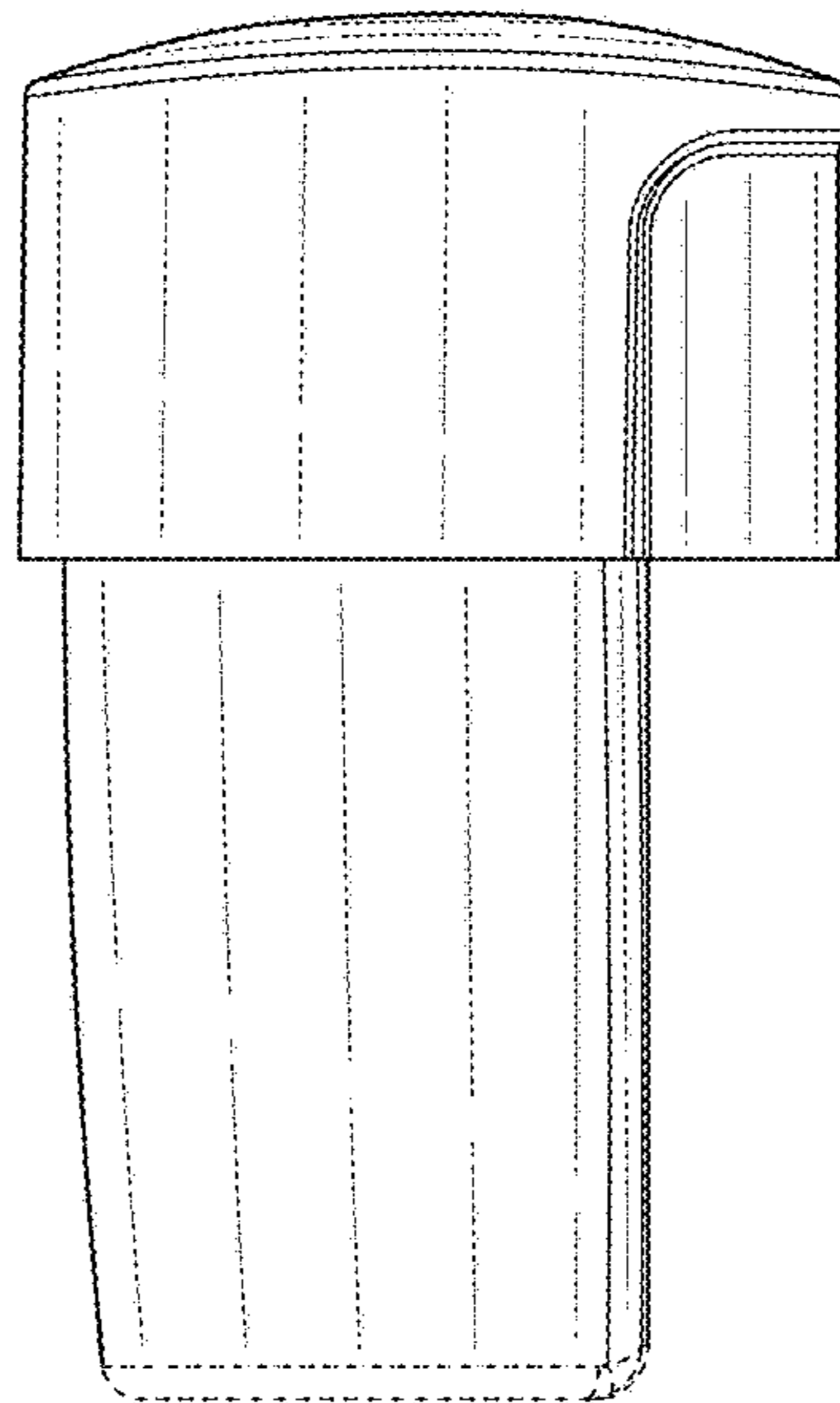

Fig. 12

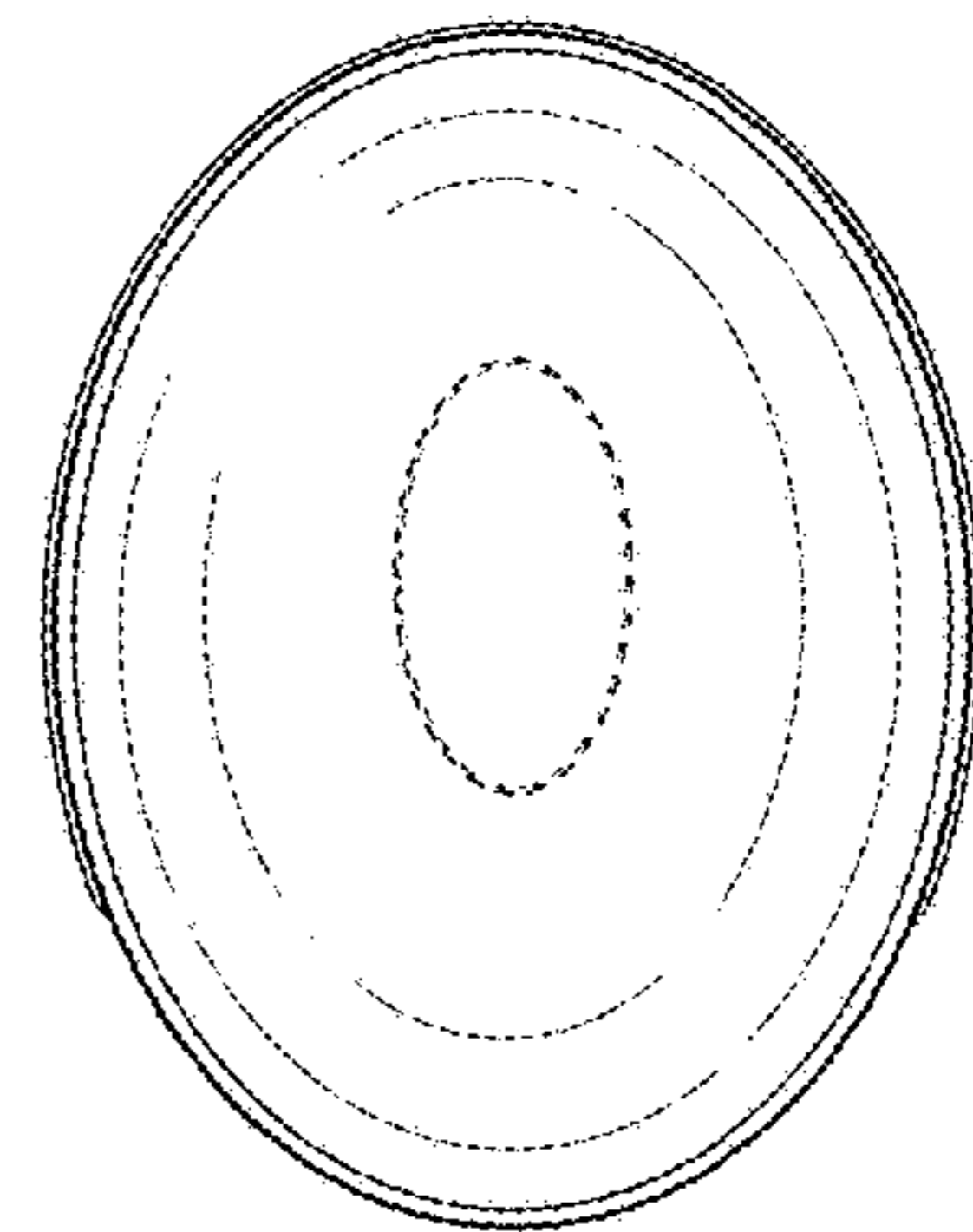

Fig. 13

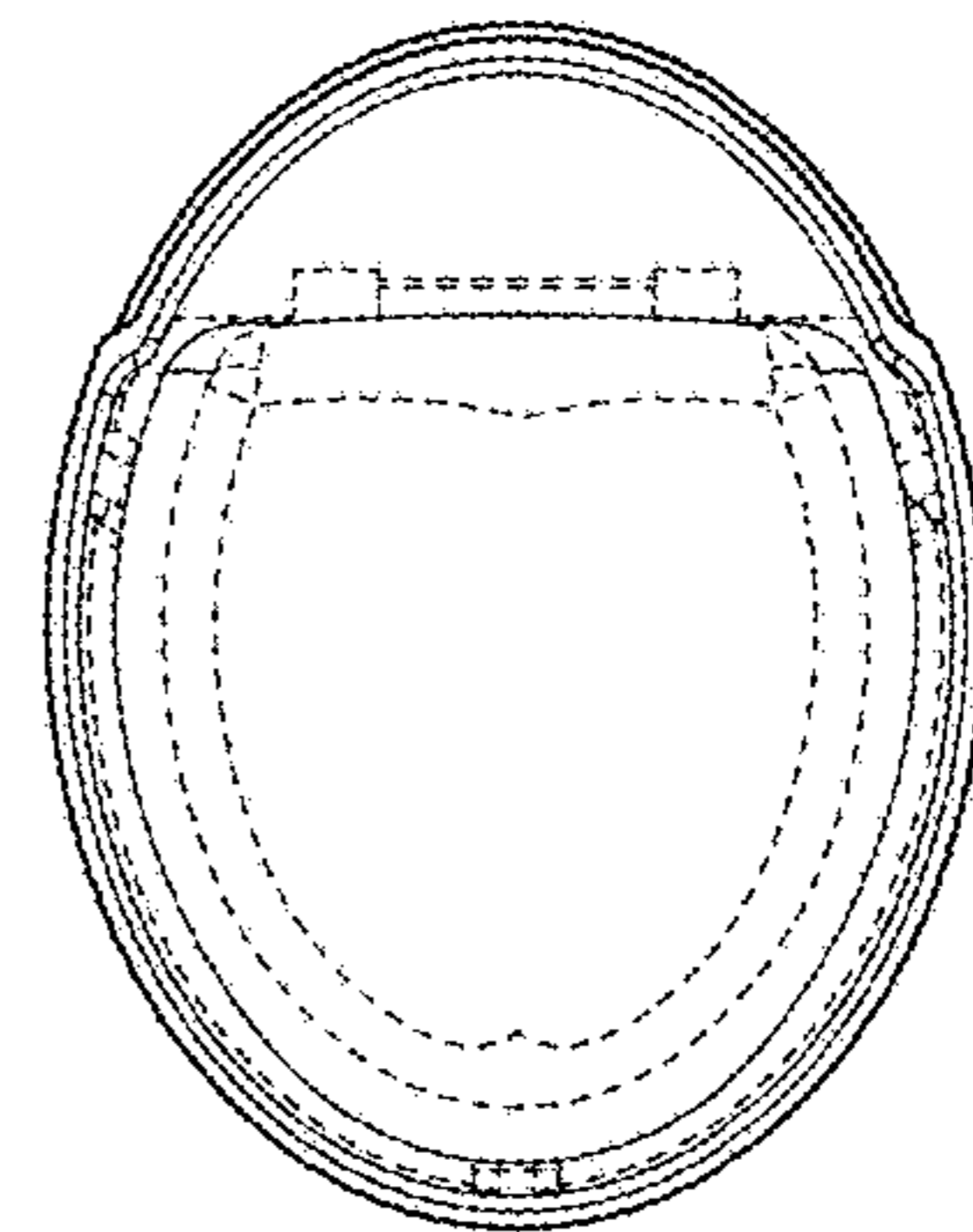

Fig. 14