



US00D807974S

(12) **United States Design Patent**
Appleyard et al.

(10) **Patent No.:** **US D807,974 S**
(45) **Date of Patent:** **** Jan. 16, 2018**

- (54) **LACROSSE PADDLE**
- (71) Applicant: **PensacoLacrosse Paddles LLC**,
Pensacola, FL (US)
- (72) Inventors: **Richard Ray Appleyard**, Pensacola,
FL (US); **Michael Allen Harnack**,
Beijing (CN)
- (**) Term: **15 Years**
- (21) Appl. No.: **29/563,332**
- (22) Filed: **May 4, 2016**
- (51) **LOC (11) Cl.** **21-02**
- (52) **U.S. Cl.**
USPC **D21/724**
- (58) **Field of Classification Search**
USPC D21/722-724, 729-732
CPC B63H 16/04; A63B 67/002; A63B 65/00;
A63B 65/12; A63B 59/20; A63B 60/00;
A63B 60/46; A63B 59/40; A63B 67/22
See application file for complete search history.

- 3,961,792 A * 6/1976 Shankel A63B 67/06
273/402
- 5,018,746 A * 5/1991 Cardoza, Jr. A63B 67/002
473/474
- 5,348,307 A * 9/1994 Duggan A63B 67/22
273/329
- 8,100,733 B1 * 1/2012 Ross B63H 16/04
440/101

* cited by examiner

Primary Examiner — Mitchell Siegel

(56) **References Cited**

U.S. PATENT DOCUMENTS

- 1,189,921 A * 7/1916 Cory A63B 59/20
473/515
- 2,480,264 A * 8/1949 Regenold A63B 59/20
473/515

(57) **CLAIM**

The ornamental design for a lacrosse paddle, as shown and described.

DESCRIPTION

FIG. 1 is a perspective view for a new design for a lacrosse paddle;
 FIG. 2 is a top plan view thereof;
 FIG. 3 is a bottom plan view thereof;
 FIG. 4 is a left end view thereof, the undisclosed opposite end being identical;
 FIG. 5 is a front elevational view thereof; and,
 FIG. 6 is a rear elevational view thereof.

1 Claim, 6 Drawing Sheets

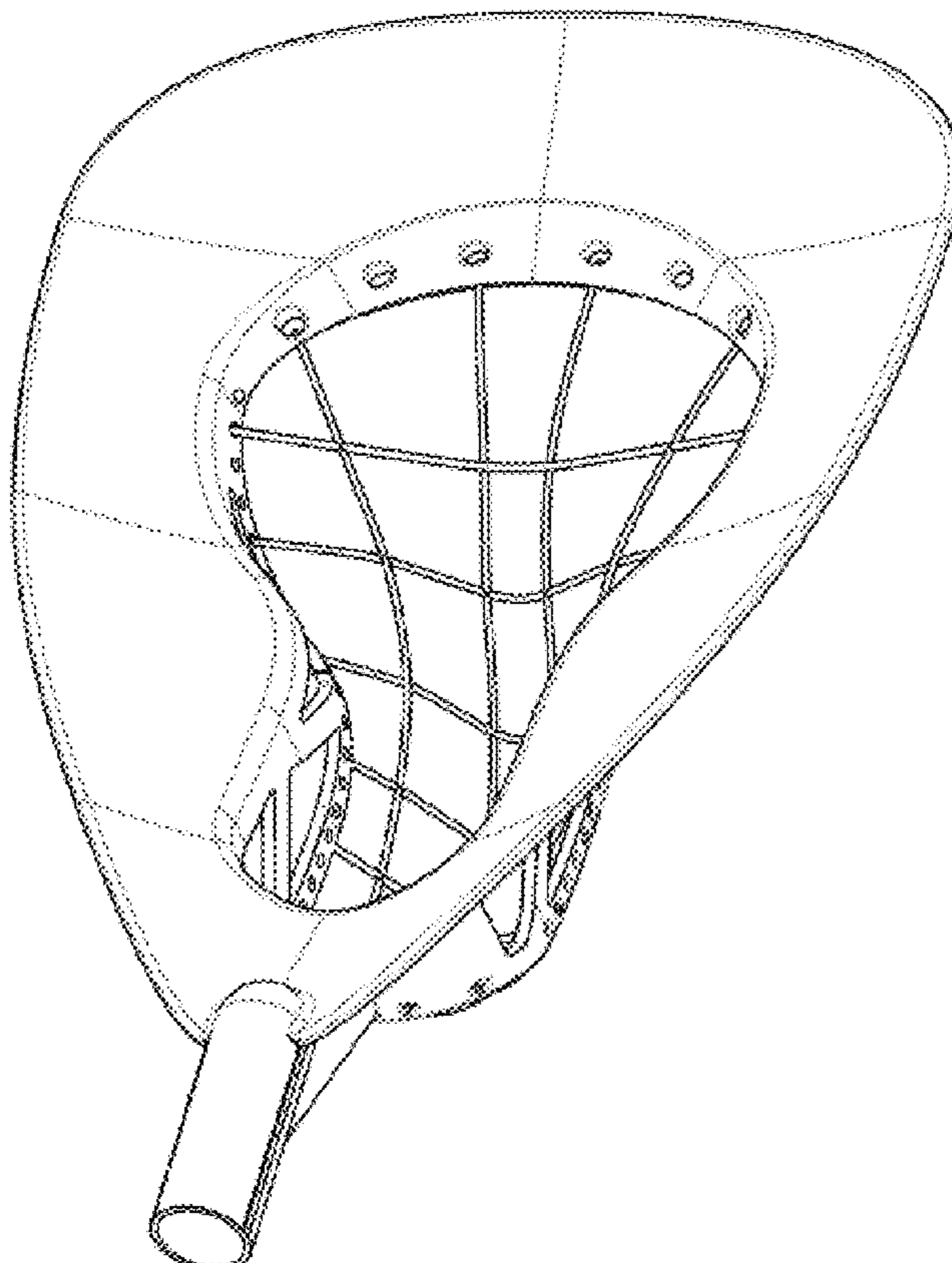

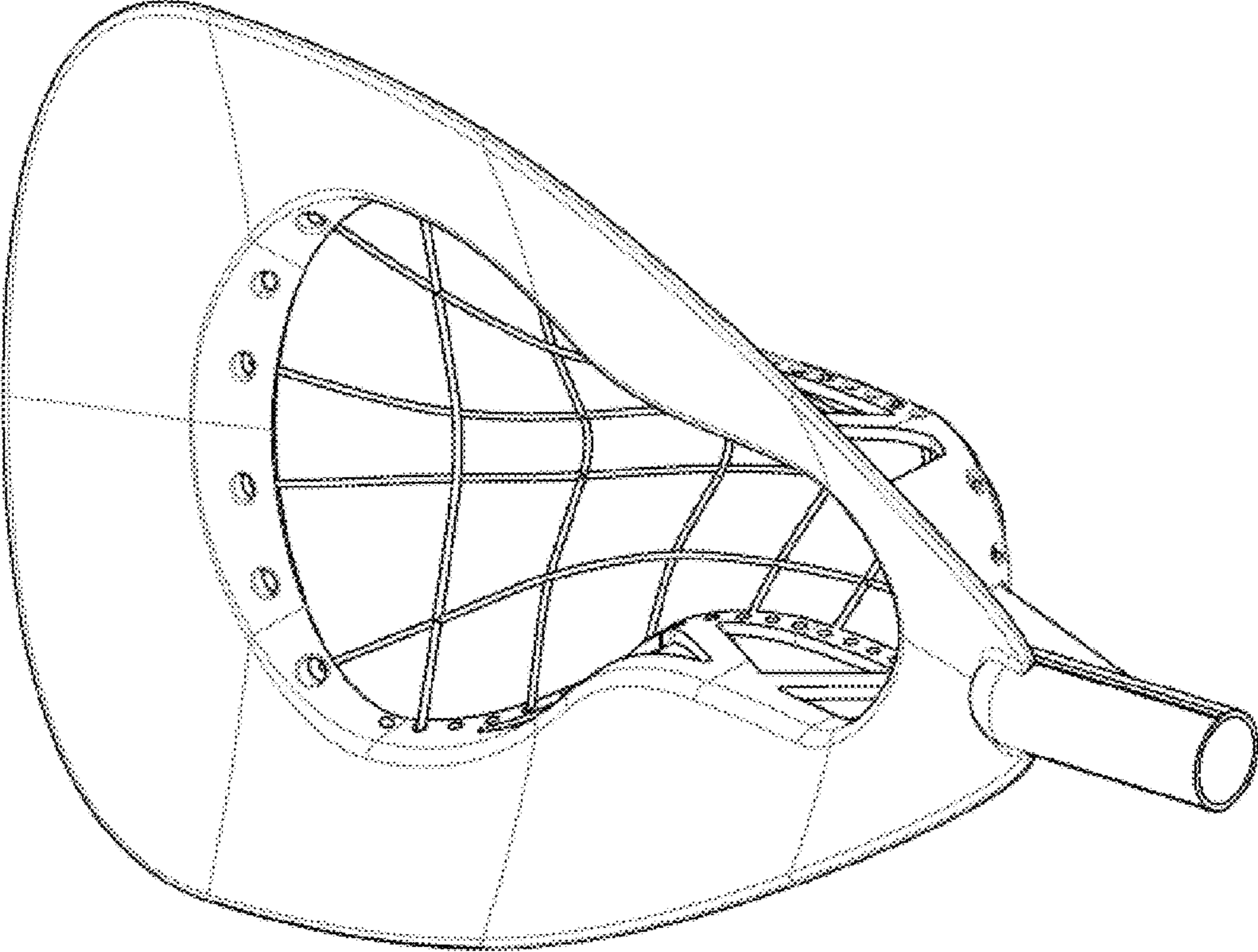

Fig. 1

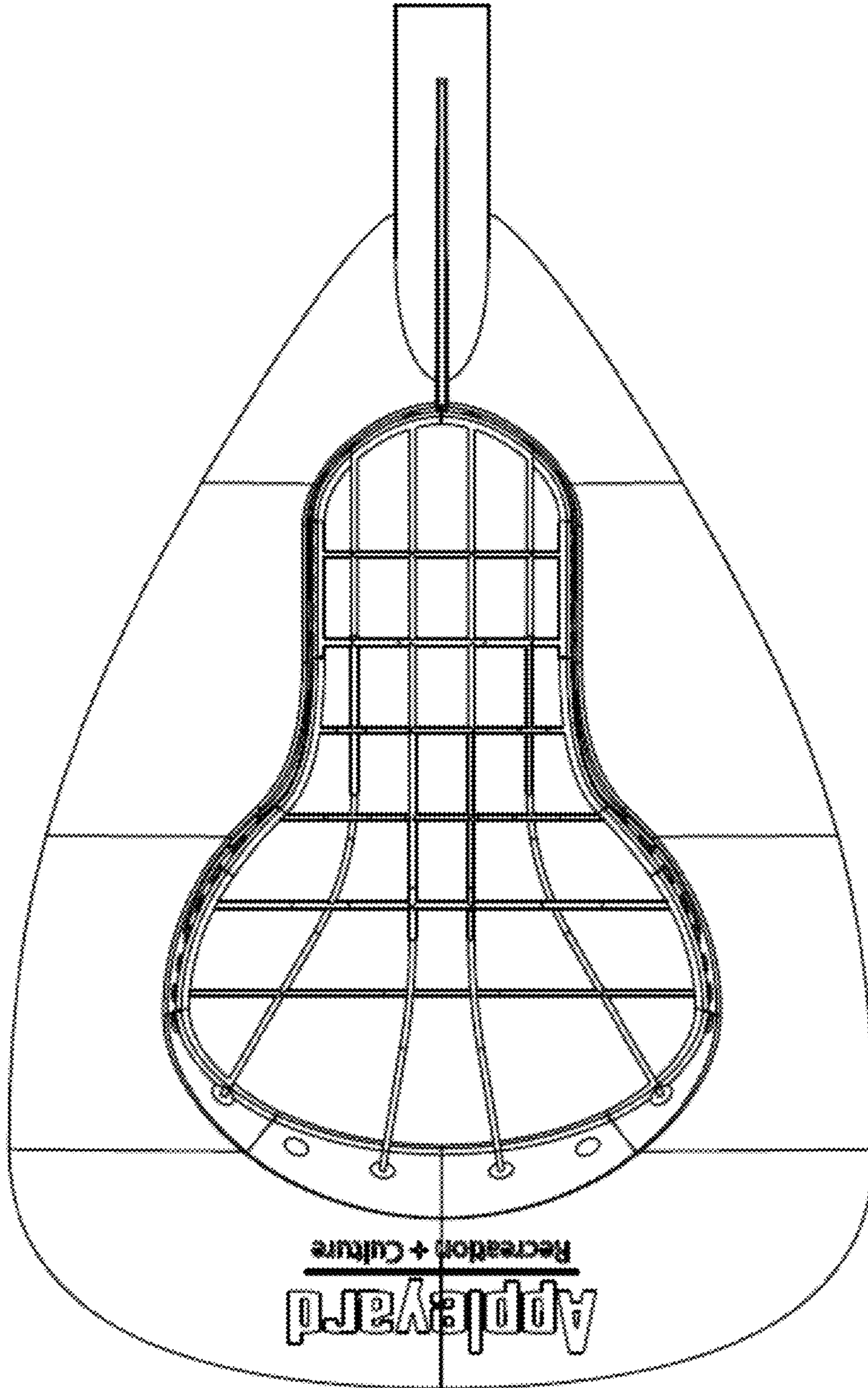

Fig. 2

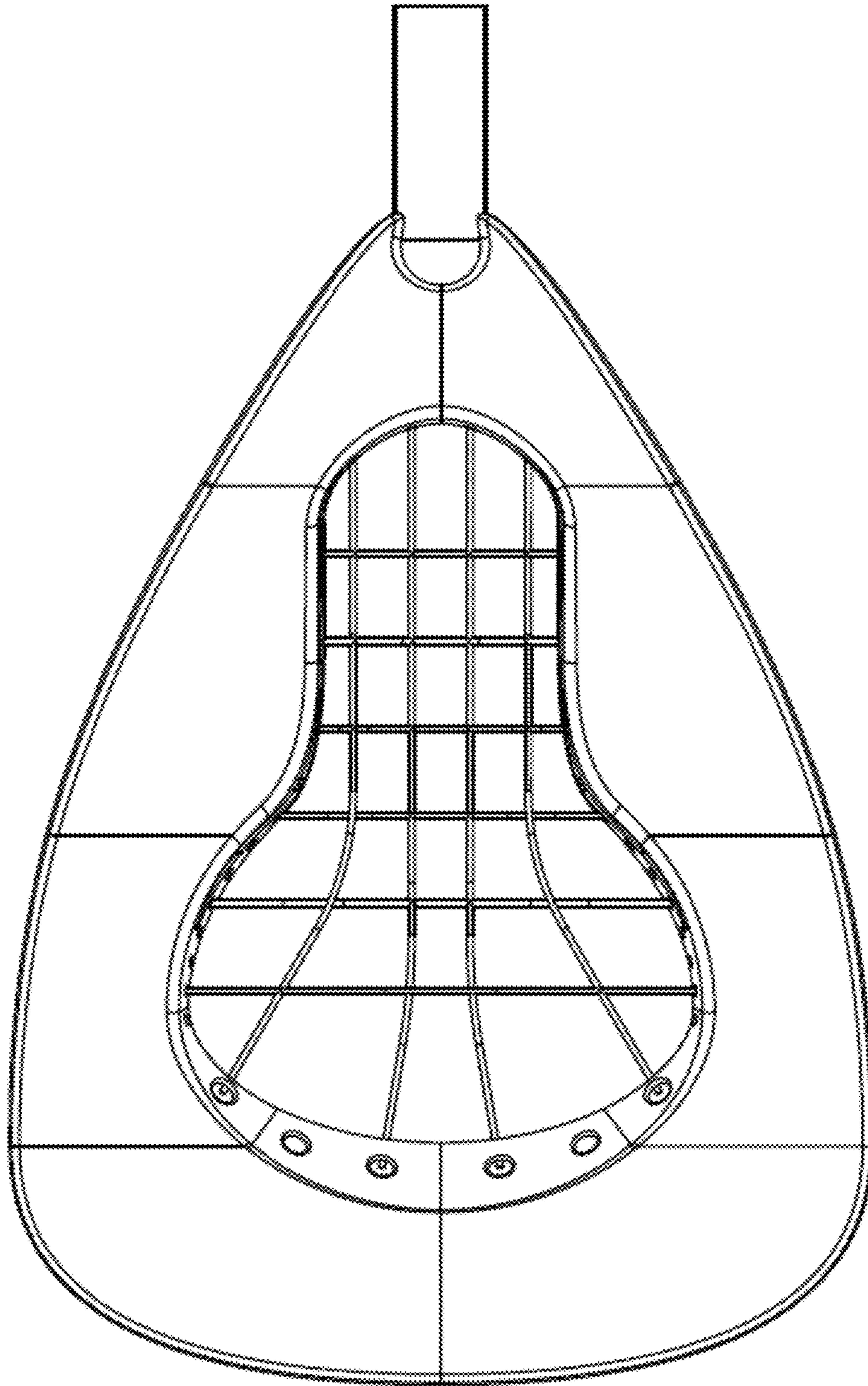

Fig. 3

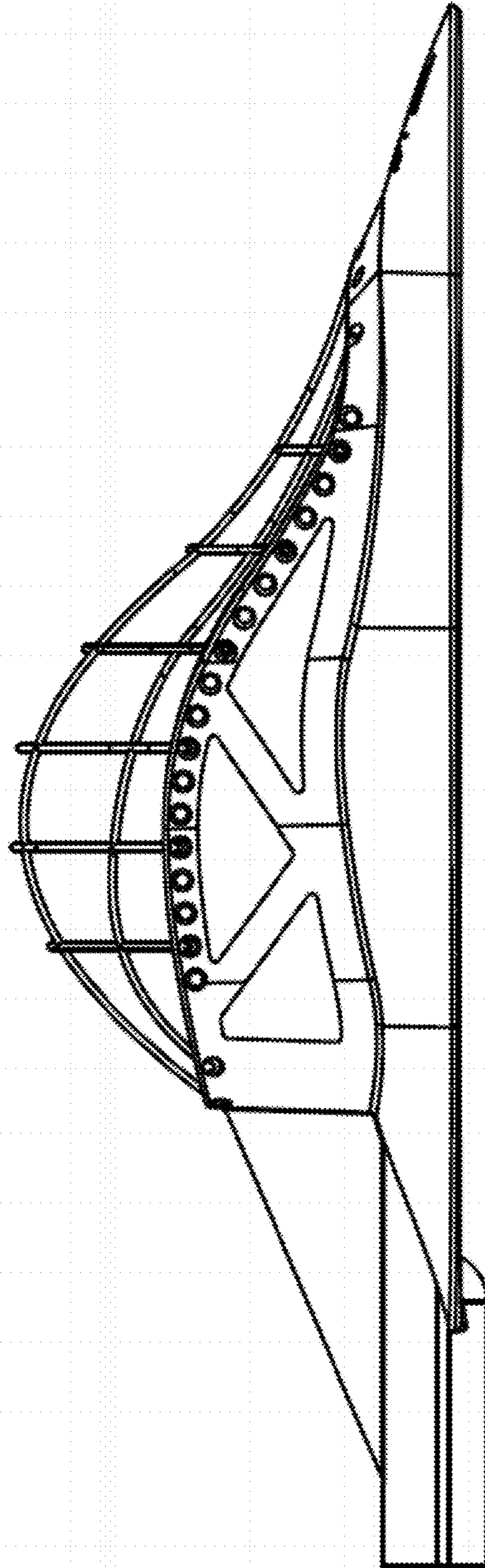

Fig. 4

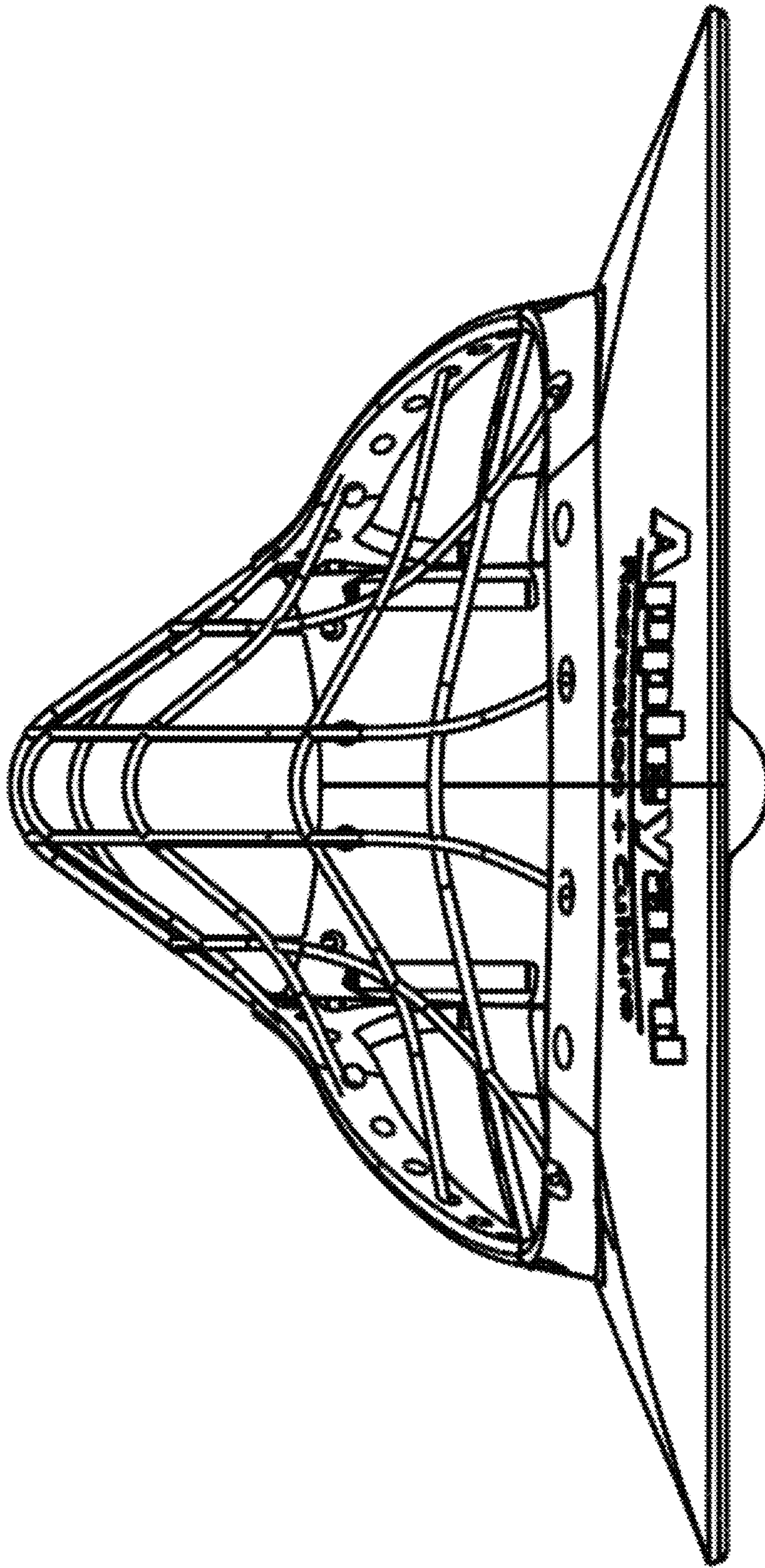

Fig. 5

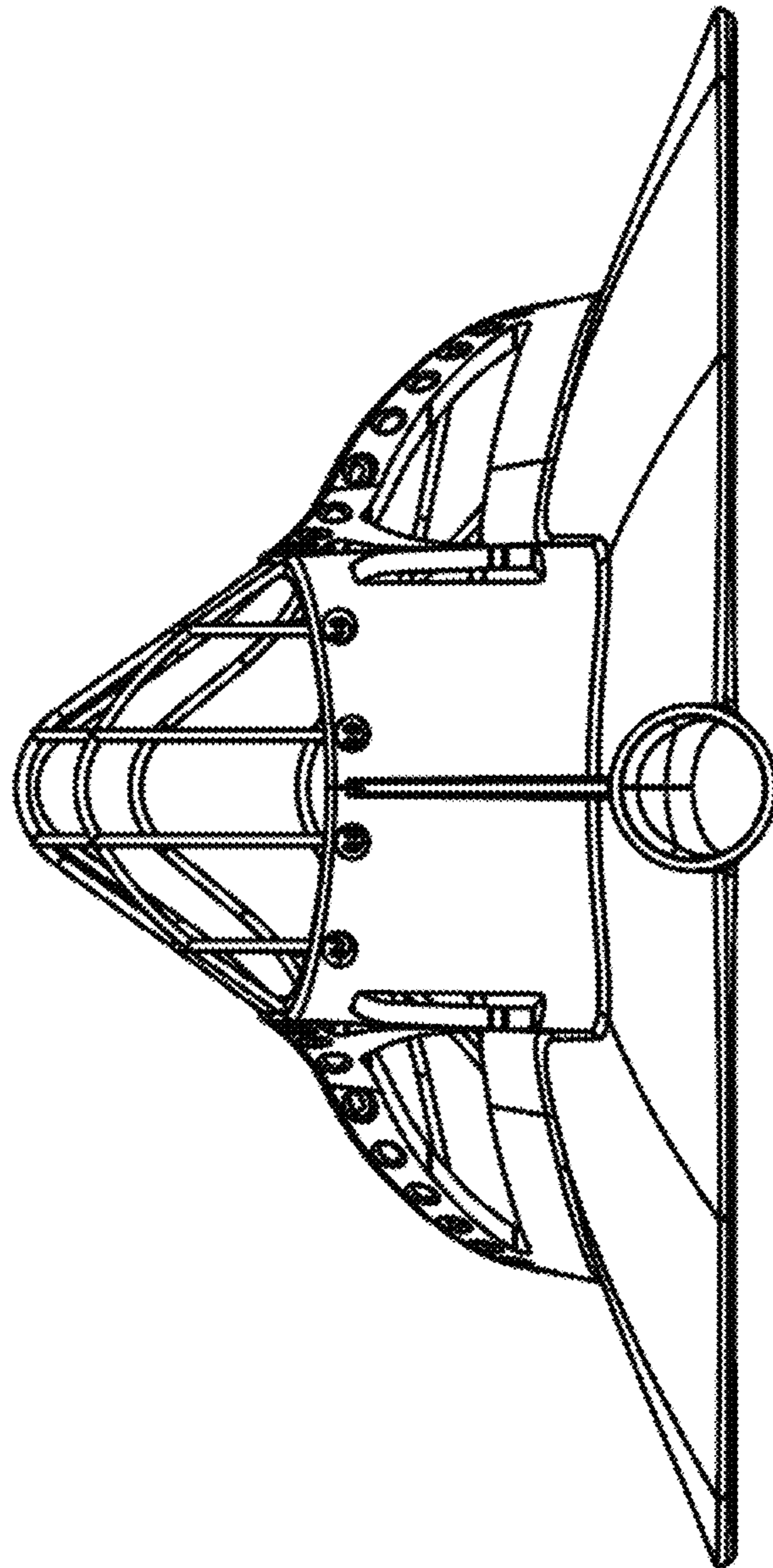

Fig. 6