



US00D807965S

(12) **United States Design Patent** (10) **Patent No.:** **US D807,965 S**
Lo (45) **Date of Patent:** **** Jan. 16, 2018**

(54) **ANIMAL BUBBLE MAKER**
(71) Applicant: **Wing Hing Manufacturing Co. Ltd.,**
Tsuen wan (HK)
(72) Inventor: **Wai Chung Lo, Tsuen Wan (HK)**
(73) Assignee: **Wing Hing Manufacturing Co. Ltd.,**
Hong Kong (HK)
(**) Term: **15 Years**

D409,715 S * 5/1999 Cruz D11/184
D520,407 S * 5/2006 Zhang D11/158
D576,768 S * 9/2008 Schulte D21/599
D577,774 S * 9/2008 Lo D21/401
D642,629 S * 8/2011 Lo D21/401
D643,477 S * 8/2011 Lo D21/401
D670,771 S * 11/2012 Lo D21/597
D716,381 S * 10/2014 Lo D21/401
D717,880 S * 11/2014 Chen D21/401
D793,492 S * 8/2017 Zanger D21/597
2012/0220184 A1* 8/2012 Orem A63H 33/28
446/16

(21) Appl. No.: **29/586,121**
(22) Filed: **Nov. 30, 2016**
(51) **LOC (11) Cl.** **21-01**
(52) **U.S. Cl.**
USPC **D21/401; D21/597**
(58) **Field of Classification Search**
USPC D21/401, 405, 406, 585, 597, 599;
446/15, 16, 72-74, 153-159, 475, 483,
446/484
CPC A63H 3/003; A63H 3/005; A63H 3/26;
A63H 13/00; A63H 23/00; A63H 23/10;
A63H 33/28; A63H 13/02
See application file for complete search history.

FOREIGN PATENT DOCUMENTS

CN 301824807 * 2/2012
CN 302651578 * 11/2013

(Continued)

Primary Examiner — Catherine A Tuttle
(74) *Attorney, Agent, or Firm* — Fisher Broyles LLP

(57) **CLAIM**

The ornamental design for an animal bubble maker, as shown and described.

DESCRIPTION

FIG. 1 is a top front and right perspective view of the animal bubble maker showing my new design;
FIG. 2 is another top front and right perspective view thereof;
FIG. 3 is a front view thereof;
FIG. 4 is a back view thereof;
FIG. 5 is a right side view thereof;
FIG. 6 is a left side view thereof;
FIG. 7 is a top view thereof; and,
FIG. 8 is a bottom plan view thereof.
The broken lines are included for the purpose of illustrating the portions of the animal bubble maker that form no part of the claimed design.

(56) **References Cited**

U.S. PATENT DOCUMENTS

D162,414 S * 3/1951 Joyce D21/401
D186,610 S * 11/1959 Allen et al. D21/401
3,021,639 A * 2/1962 Allen A63H 33/28
40/408
D245,804 S * 9/1977 Cone D21/599
4,262,443 A * 4/1981 Ferris A63H 13/02
446/289
D329,657 S * 9/1992 Nakamura D17/22
D338,041 S * 8/1993 Cheng D19/65
5,297,979 A * 3/1994 Amron A63H 33/28
239/211
D403,239 S * 12/1998 Ying D21/597

1 Claim, 8 Drawing Sheets

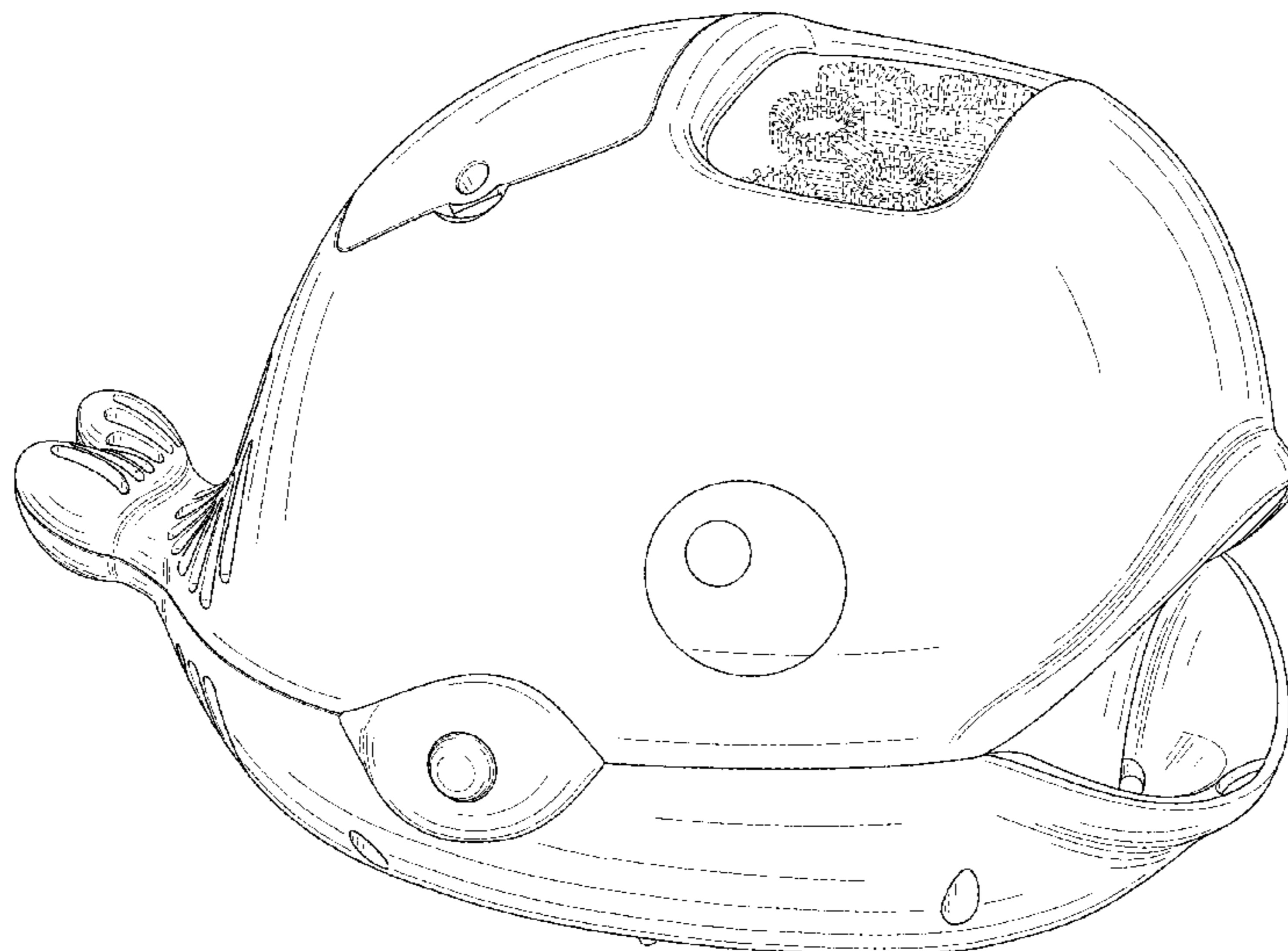

(56)

References Cited

FOREIGN PATENT DOCUMENTS

CN	302857857	*	6/2014	
CN	303108462	*	2/2015	
CN	303533142	*	12/2015	
CN	304232677	*	8/2017	
EM	003560994-0001	*	3/2017	
JP	D1580522	*	7/2017	
WO	WO-2017111497 A1	*	6/2017 A63H 23/06

* cited by examiner

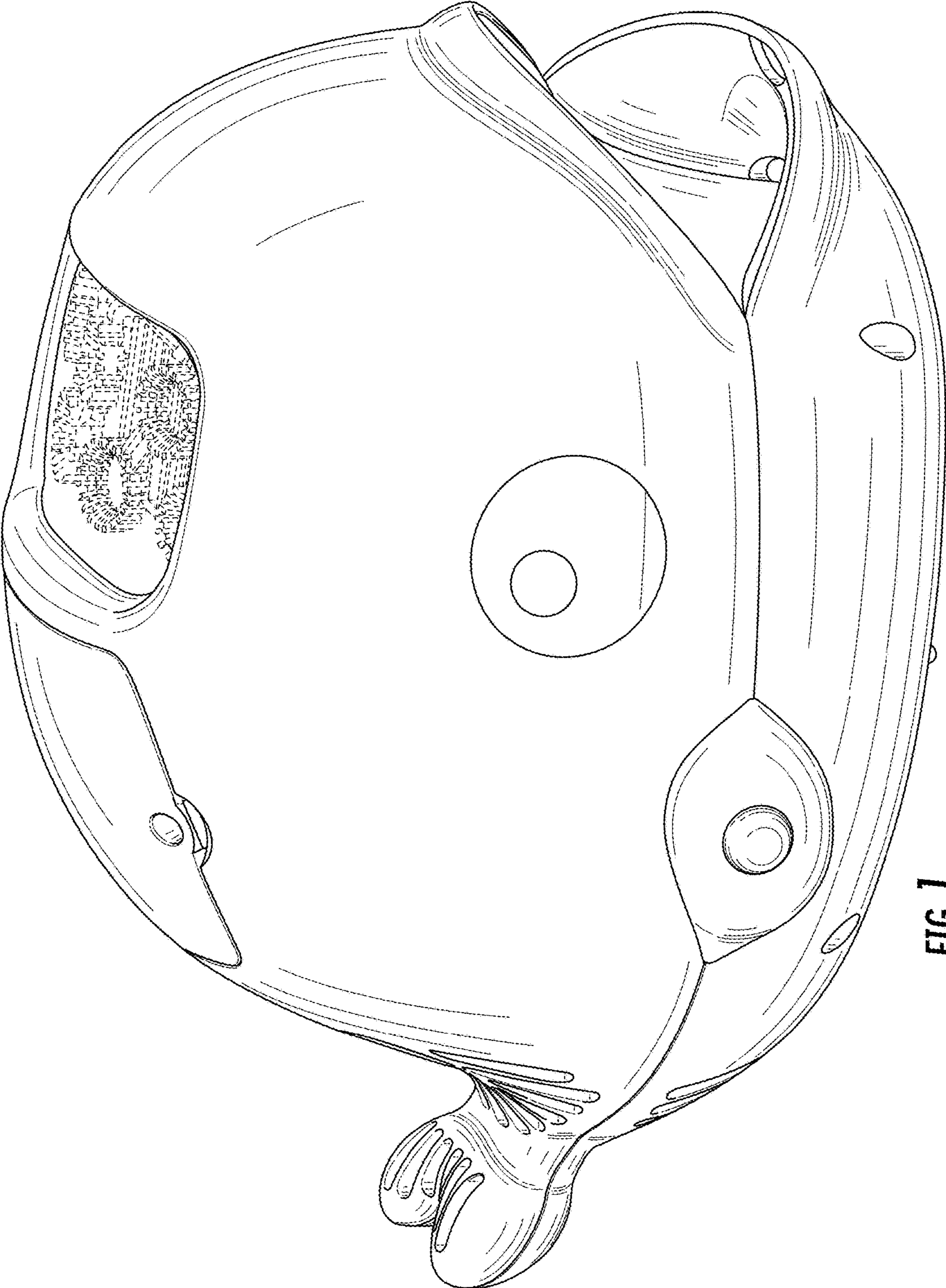

FIG. 1

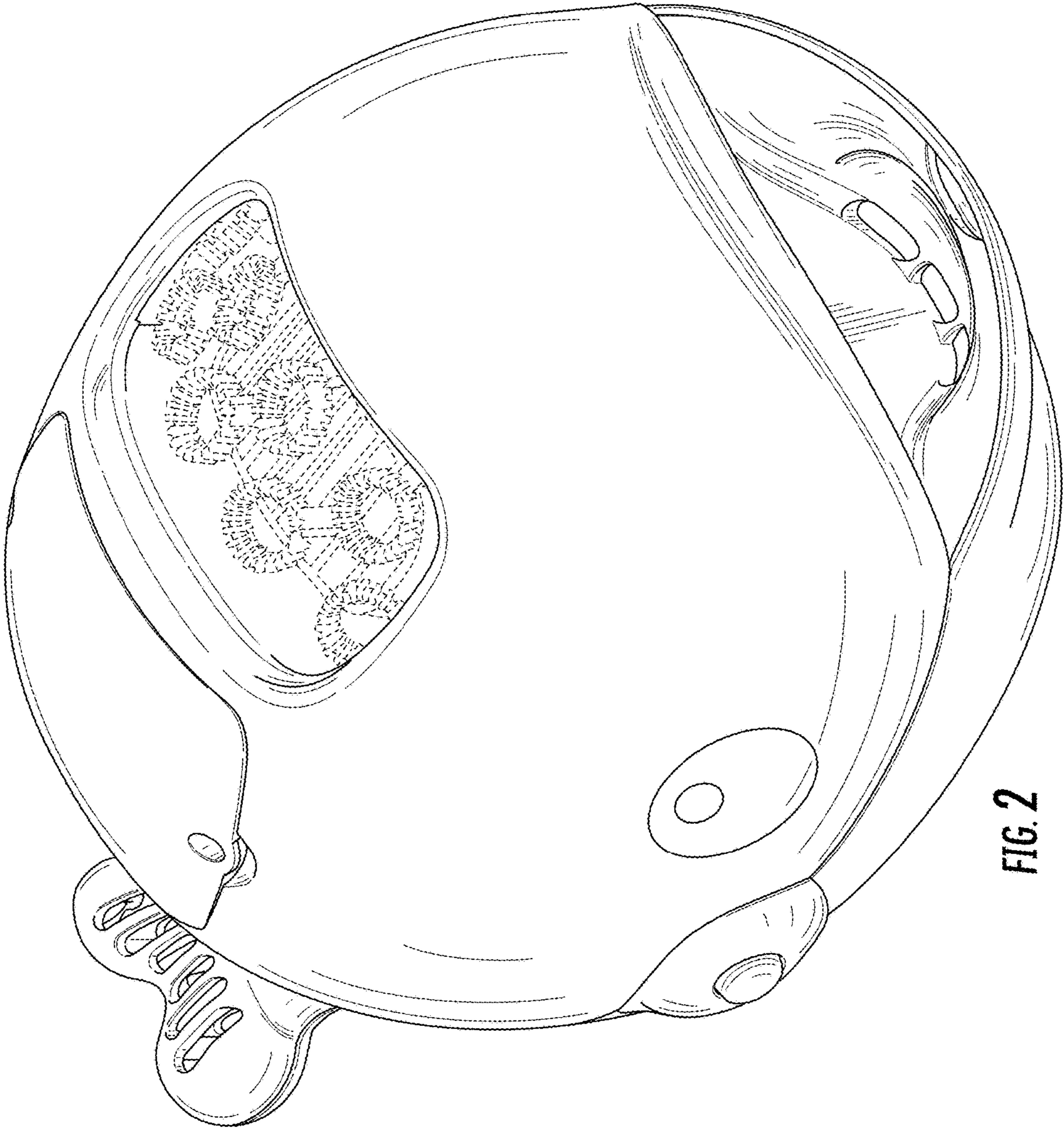

FIG. 2

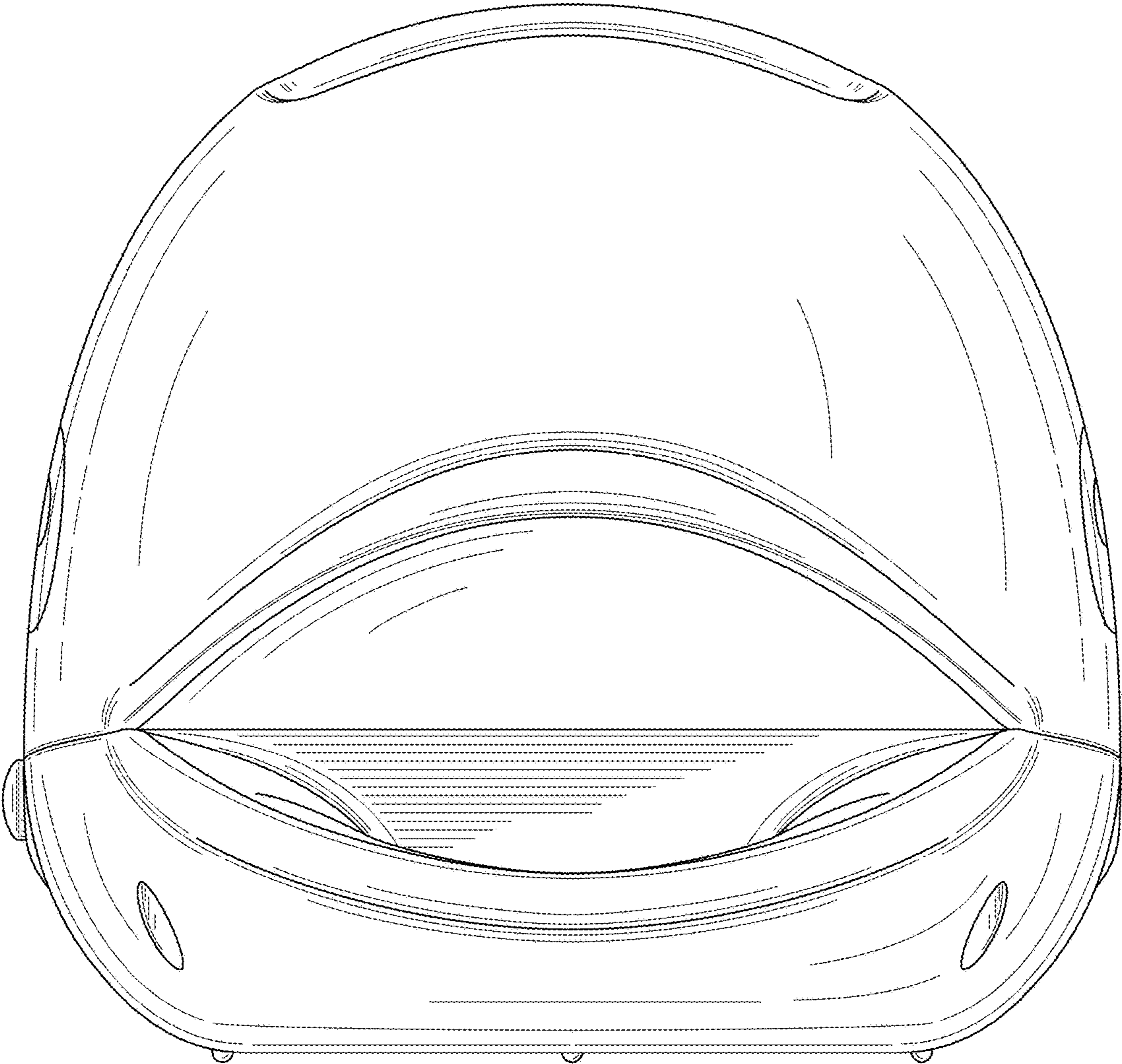

FIG. 3

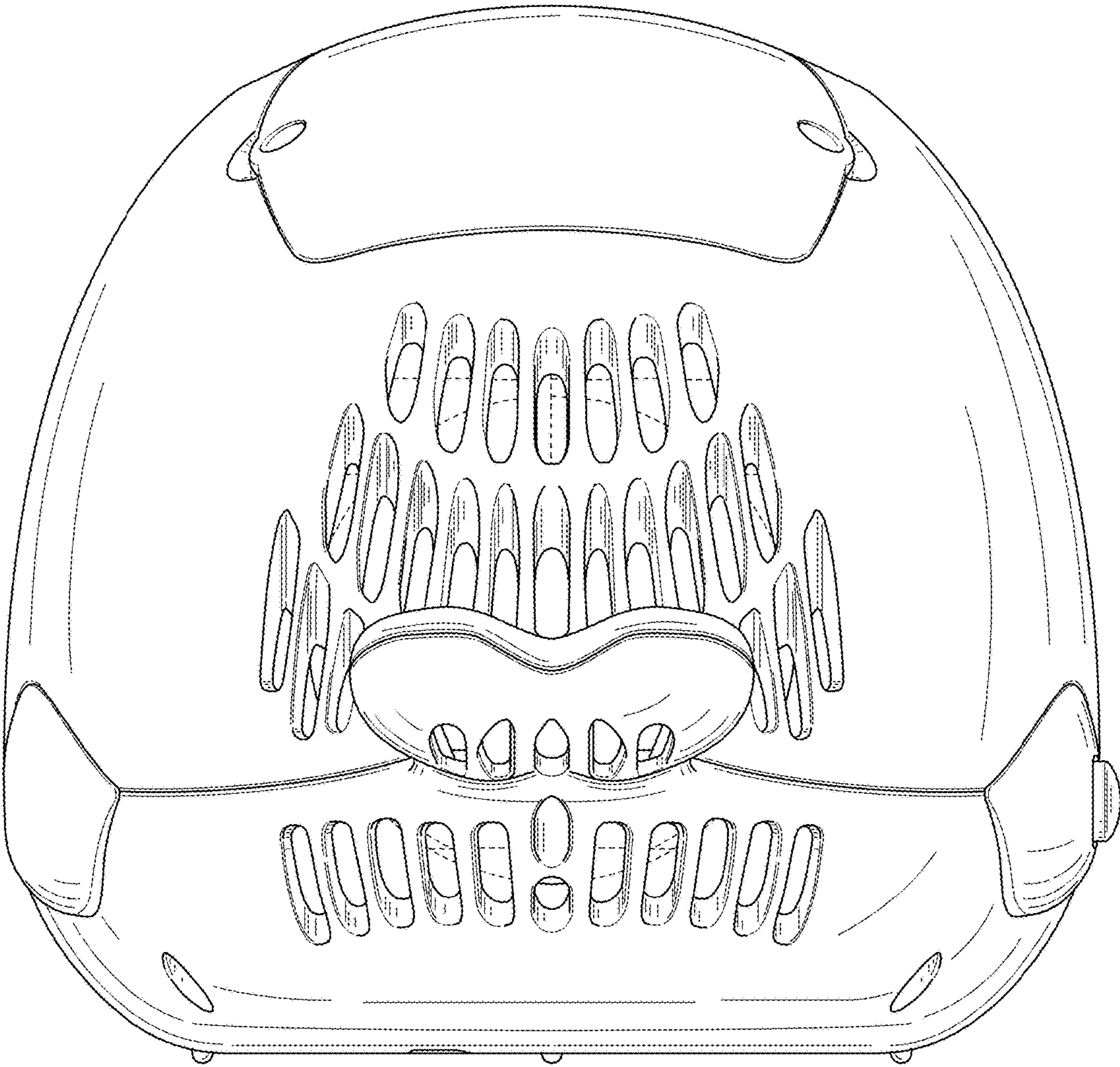

FIG. 4

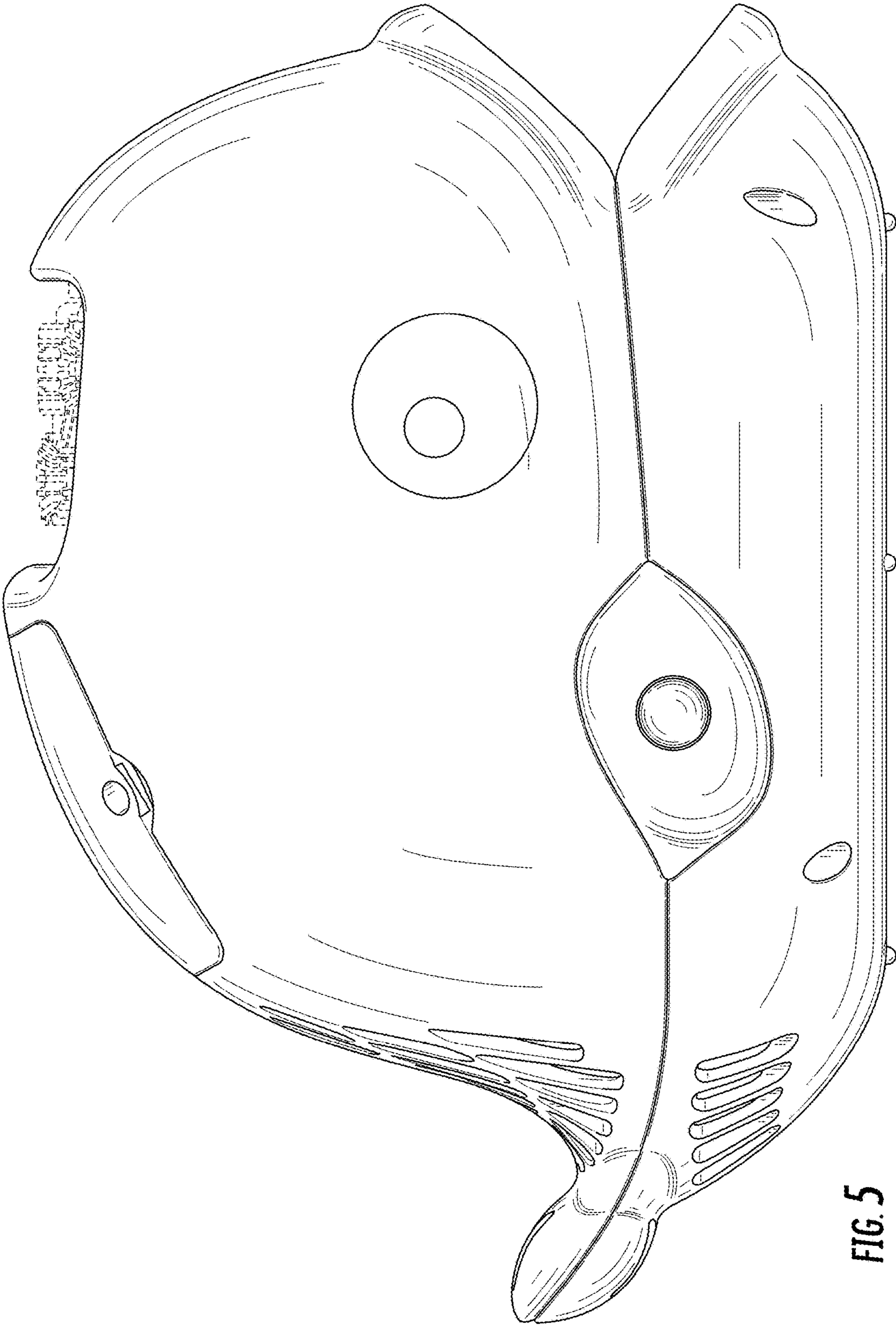

FIG. 5

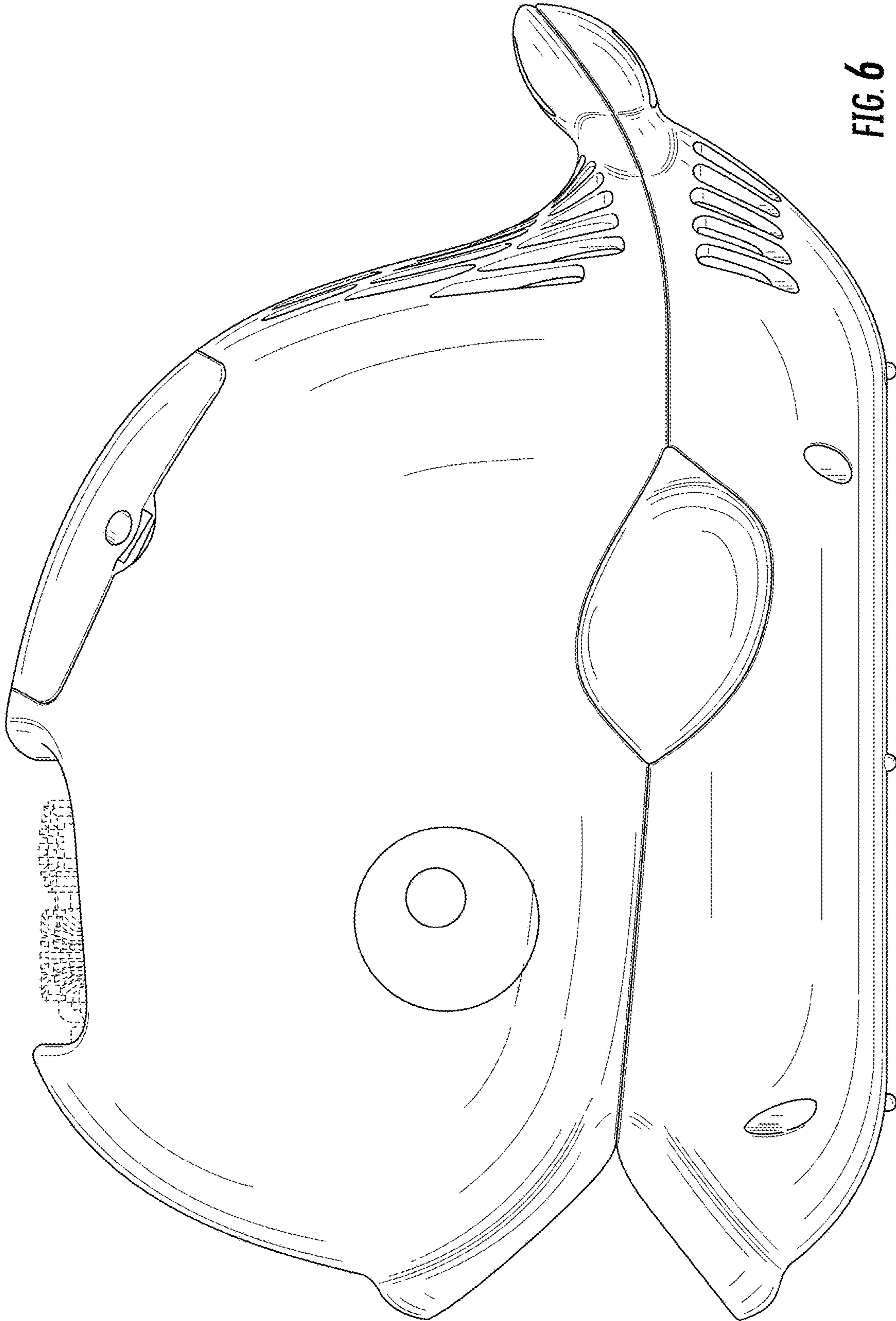

FIG. 6

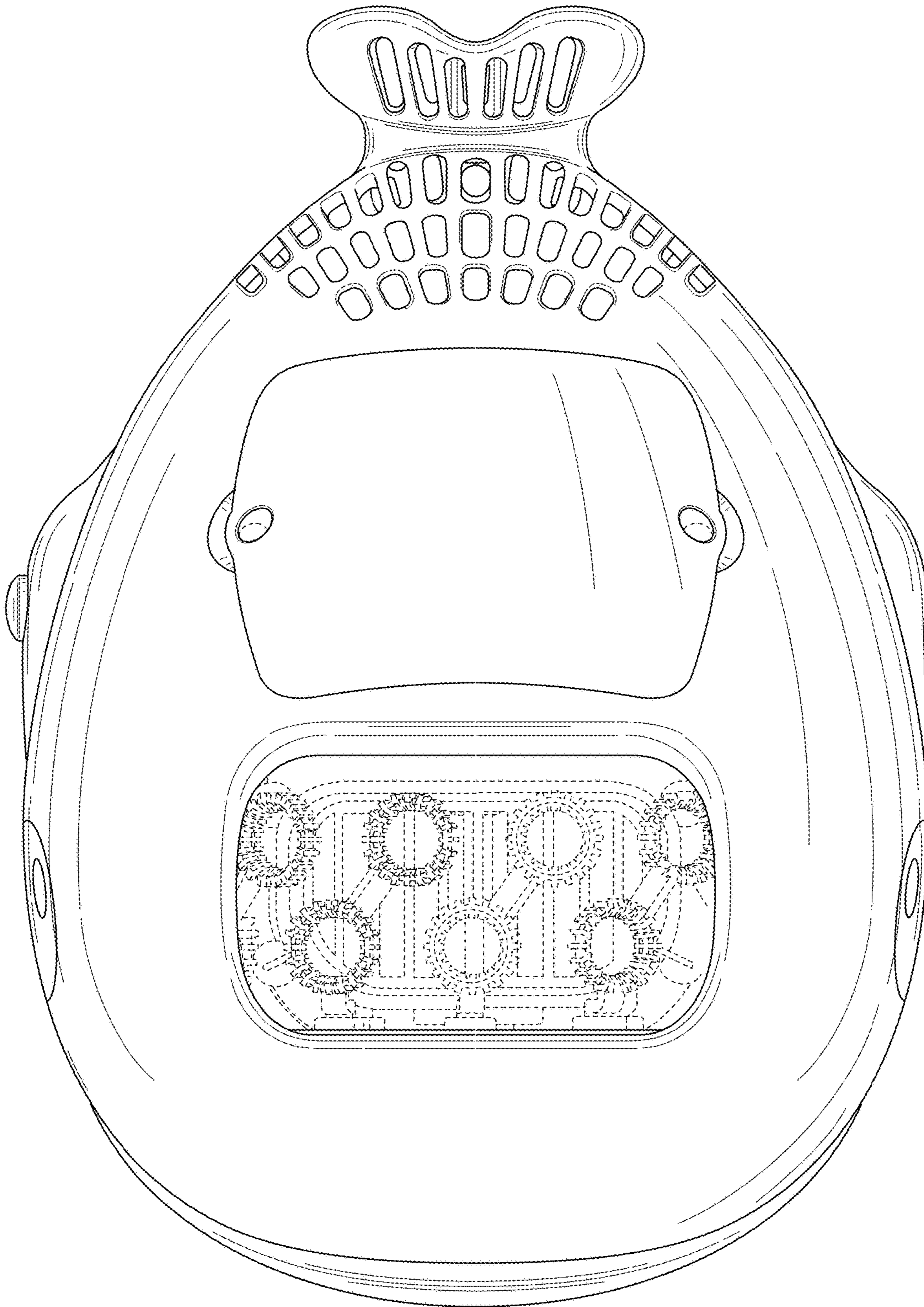

FIG. 7

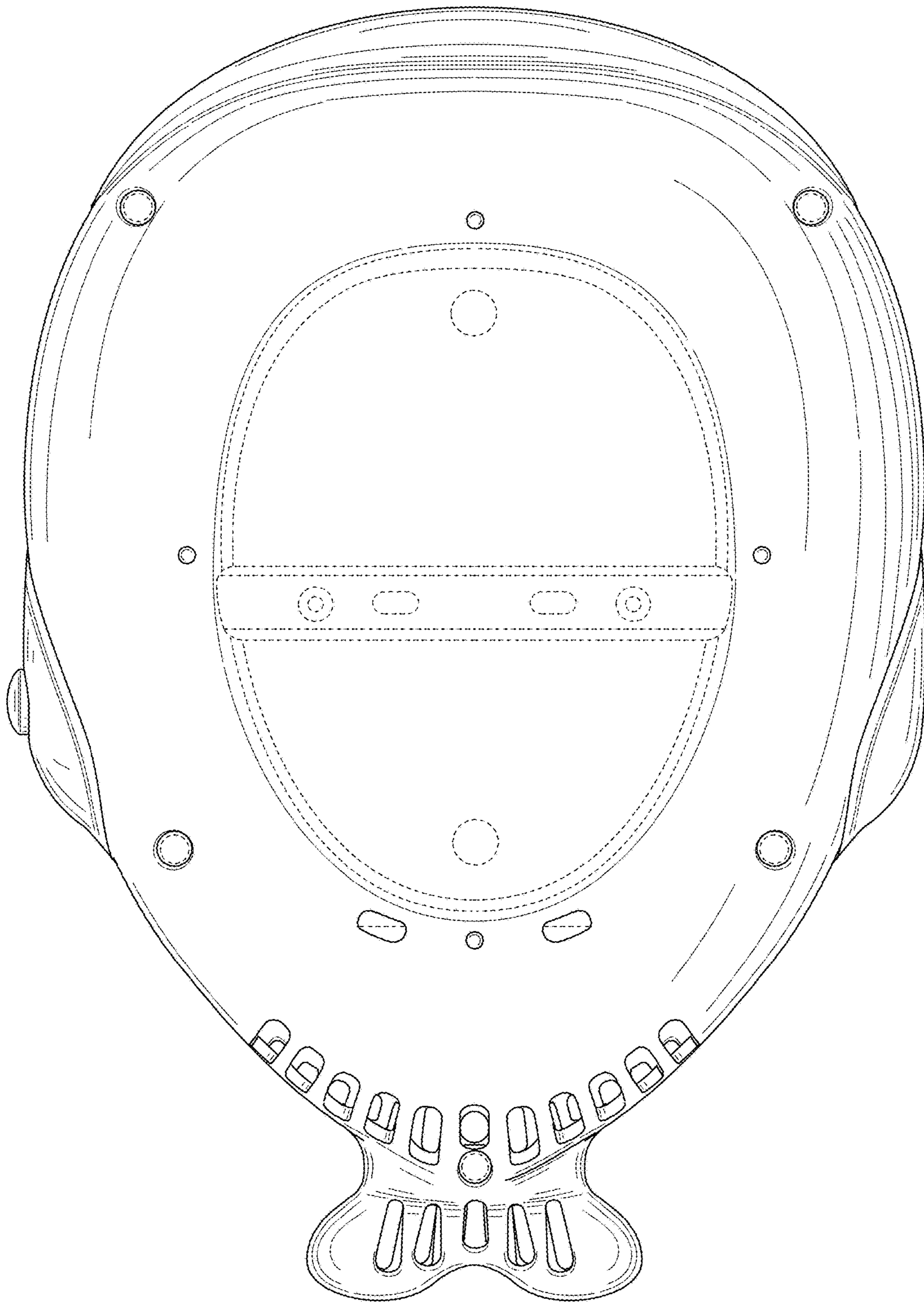

FIG. 8