



US00D807950S

(12) **United States Design Patent**
Steinberger

(10) **Patent No.:** **US D807,950 S**
(45) **Date of Patent:** **** Jan. 16, 2018**

(54) **SIDE MOUNT CAPO**

FOREIGN PATENT DOCUMENTS

(71) Applicant: **D’Addario & Company, Inc.**,
Farmingdale, NY (US)

CN 201330565262 * 11/2013
WO WO-2009091936 A1 * 7/2009 G10D 3/043

(72) Inventor: **Richard Ned Steinberger**, Nobleboro,
ME (US)

OTHER PUBLICATIONS

(73) Assignee: **D’Addario & Company, Inc.**,
Farmingdale, NY (US)

Amazon,ARoma AC-03 Ukulele Capo, first available on Aug. 31,
2014, [online], [site visited on Nov. 2, 2017].Available from Inter-
net, <URL: <https://www.amazon.com/Aroma-AC-03-Premium-Ukulele-Silver/dp/B008XVYNH4>> (Year: 2014).*

(**) Term: **15 Years**

Amazon, Planet Waves Capo, first available on Jun. 12, 2012,
[online], [site visited on Nov. 2, 2017]. Available from Internet,
<URL: https://www.amazon.com/dp/B008BPI2HE/ref=sr_1_1_twi_col_ti_2?s=musical-instruments&ie=UTF8&qid=1509652347&sr=1-1&keywords=Planet+Wave+Tri+Action+Capos> (Year:
2012).*

(21) Appl. No.: **29/577,257**

(22) Filed: **Sep. 12, 2016**

(51) **LOC (11) Cl.** **17-03**

(52) **U.S. Cl.**
USPC **D17/20**

(58) **Field of Classification Search**
USPC D17/14, 20, 21, 99; D21/684, 692, 693
CPC G10D 3/00; G10D 3/04; G10D 3/043; G10D
3/14; G10D 3/143
See application file for complete search history.

* cited by examiner

Primary Examiner — Sheryl Lane

Assistant Examiner — Samantha N Wood

(74) *Attorney, Agent, or Firm* — Law Offices of Daniel A.
Tesler, LLC

(56) **References Cited**

U.S. PATENT DOCUMENTS

D573,173	S	*	7/2008	Jackson	D17/20
D585,479	S	*	1/2009	Campling	D17/20
D673,209	S	*	12/2012	Reboul	D17/20
D680,178	S	*	4/2013	An	D21/684
8,779,262	B1	*	7/2014	Steinberger	G10D 3/043 84/318
D729,025	S	*	5/2015	Chance	D8/42
9,230,519	B1	*	1/2016	Beller	G10D 3/00
9,741,320	B2	*	8/2017	Stromberg	G10D 3/043
9,754,563	B1	*	9/2017	Chen	G10D 3/043
D801,426	S	*	10/2017	Campling	D17/20
2007/0143929	A1	*	6/2007	Selin	B25F 1/00 7/151
2010/0269666	A1	*	10/2010	D’Addario	G10D 3/043 84/318

(57) **CLAIM**

The ornamental design for a side mount capo, as shown and
described.

DESCRIPTION

FIG. 1 is a perspective view of the side mount capo, showing
my new design;
FIG. 2 is a top plan view thereof;
FIG. 3 is a bottom plan view thereof;
FIG. 4 is a front view thereof;
FIG. 5 is a rear view thereof;
FIG. 6 is a right side view thereof; and,
FIG. 7 is a left side view thereof.
The broken line portions are included to show unclaimed
subject matter only and form no part of the claimed design.

1 Claim, 5 Drawing Sheets

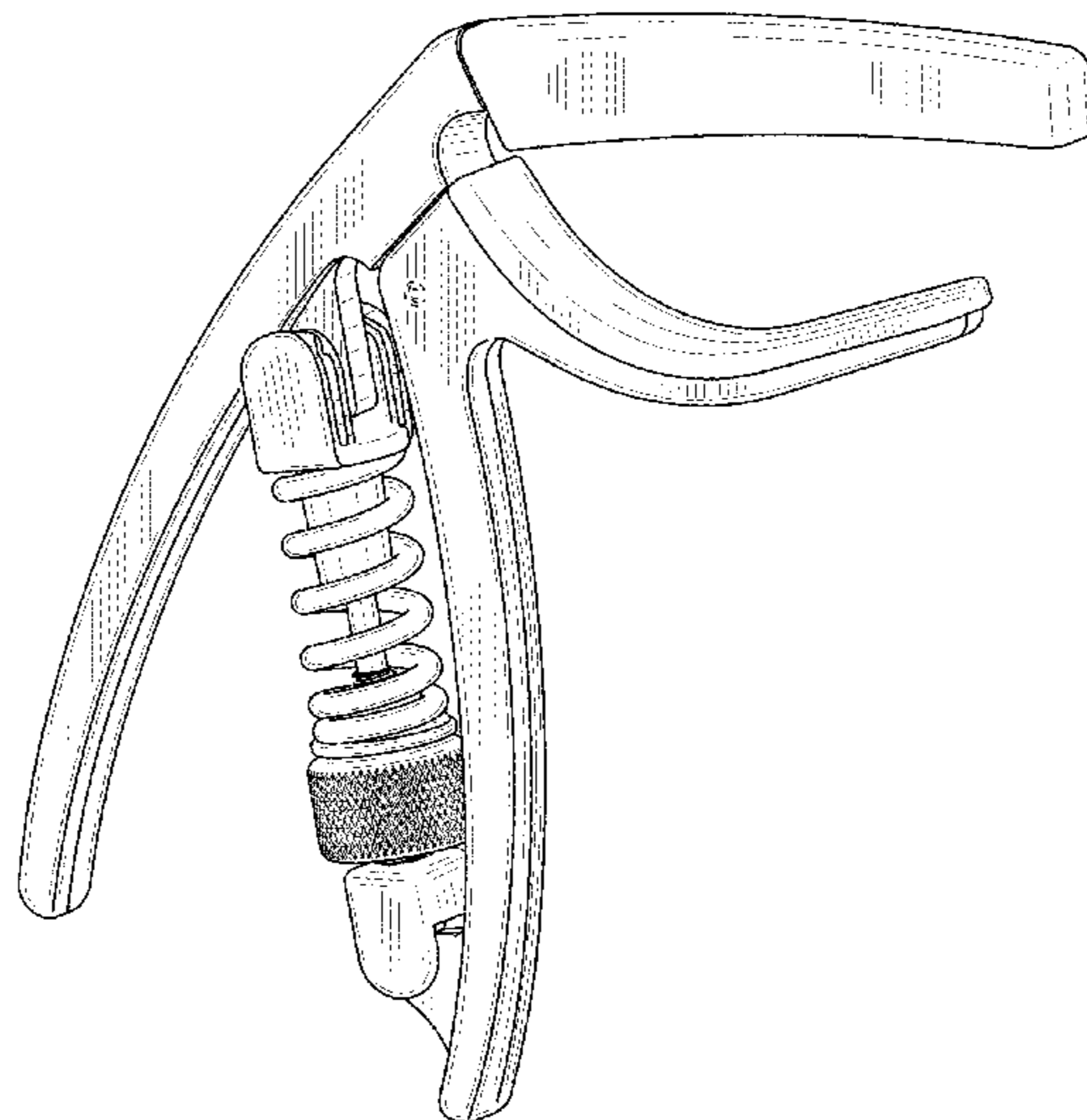
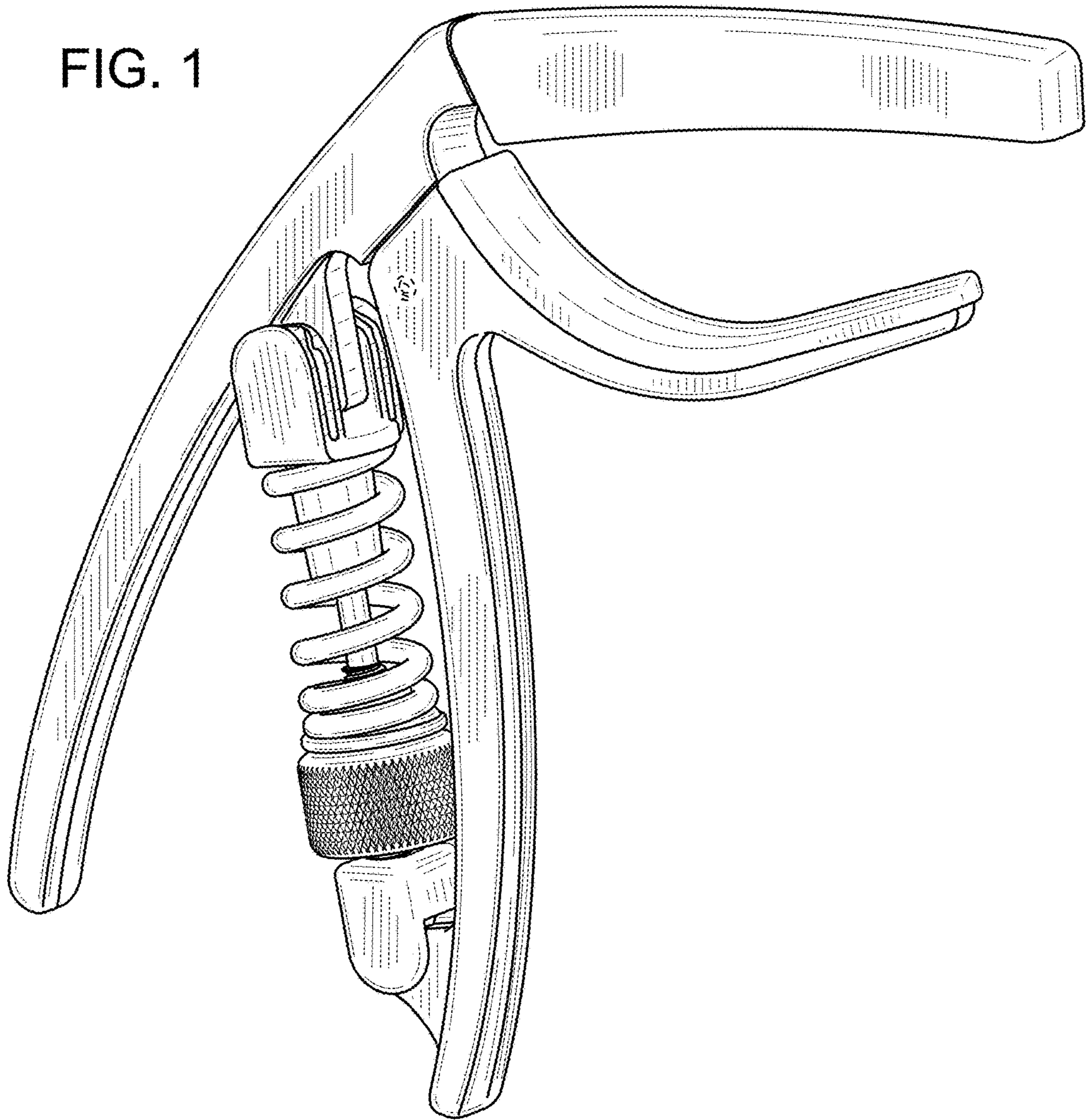

FIG. 1



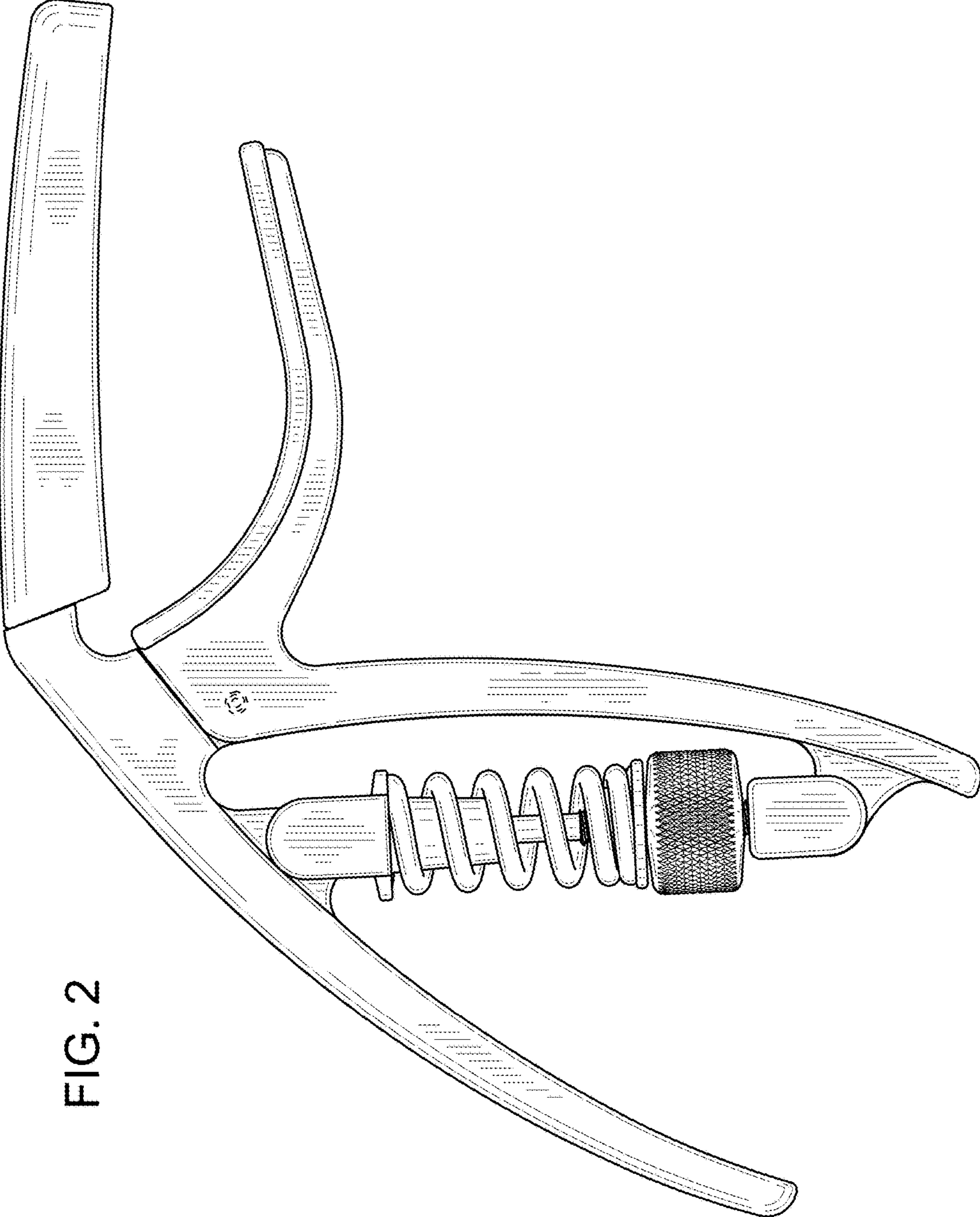

FIG. 2

FIG. 3

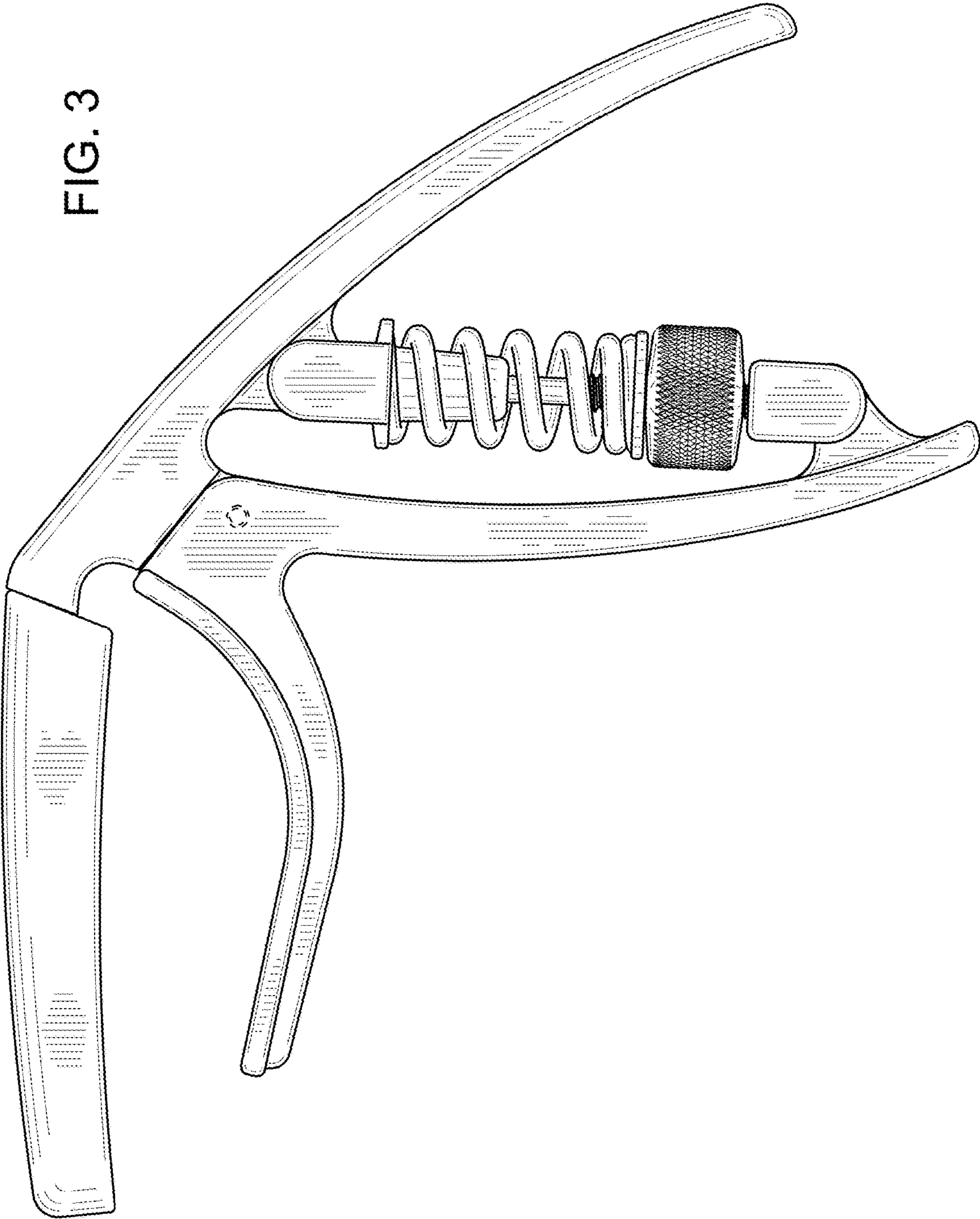

FIG. 4

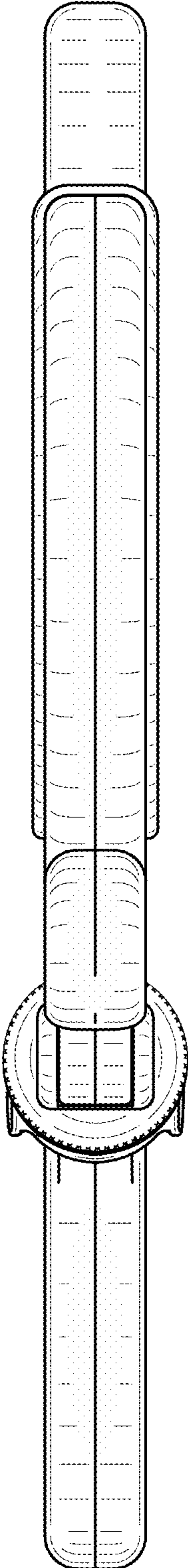

FIG. 5

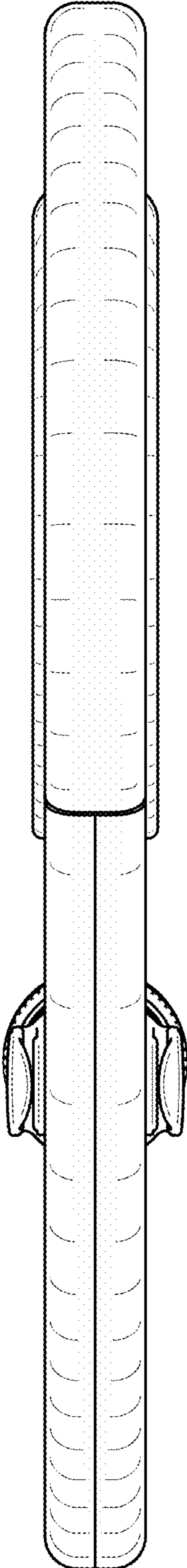

FIG. 6

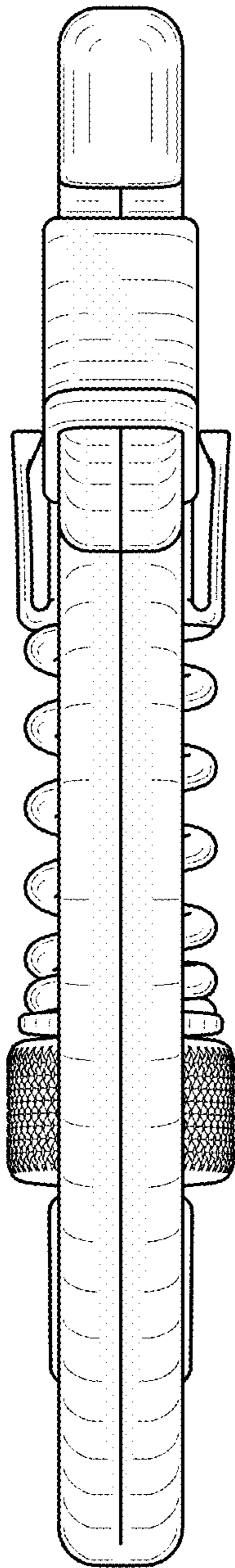

FIG. 7

