



US00D807937S

(12) **United States Design Patent** (10) **Patent No.:** **US D807,937 S**
Warr et al. (45) **Date of Patent:** **** Jan. 16, 2018**

(54) **PEEP HOLE COVER**

(71) Applicants: **William C Warr**, Palatine, IL (US);
Garret M Warr, Oak Park, IL (US)

(72) Inventors: **William C Warr**, Palatine, IL (US);
Garret M Warr, Oak Park, IL (US)

(**) Term: **14 Years**

(21) Appl. No.: **29/501,751**

(22) Filed: **Sep. 8, 2014**

Related U.S. Application Data

(63) Continuation of application No. 29/348,615, filed on
Jan. 21, 2010, now Pat. No. Des. 712,944.

(51) **LOC (11) Cl.** **16-06**

(52) **U.S. Cl.**
USPC **D16/135; D16/130**

(58) **Field of Classification Search**
USPC D16/130, 135; D20/10, 11, 22, 27;
D19/1; 40/124.5; 359/827, 738;
229/92.8; 70/74, 454, 455, 457;
D30/155; 235/492
CPC E05B 17/185; G09F 3/10
See application file for complete search history.

(56) **References Cited**

U.S. PATENT DOCUMENTS

976 A	10/1838	Nock	
296,431 A	4/1884	Miller	
373,243 A	11/1887	Miller	
593,993 A	11/1897	Elwood	
1,110,963 A	9/1914	Robinson	
1,130,241 A *	3/1915	Babcock E05D 11/0018 16/380
1,168,066 A	1/1916	Girardot	
1,396,693 A	11/1921	Rugh	
1,439,038 A	12/1922	Teich	

(Continued)

Primary Examiner — Paula Allen Greene

(74) *Attorney, Agent, or Firm* — Barich IP Law Group

(57) **CLAIM**

The ornamental design for a peep hole cover, as shown and described.

DESCRIPTION

FIG. 1 is a perspective view of an embodiment of a peep hole cover of our invention in use on a door shown in phantom.

FIG. 2 is a side view of a peep hole cover of our invention, in use on a door shown in phantom.

FIG. 3 is a top plan view of a peep hole cover of our invention in use.

FIG. 4 is a bottom plan view thereof, based on FIG. 1.

FIG. 5 is a front plan view thereof, based on FIG. 1.

FIG. 6 is a rear plan view thereof and a reverse view of FIG. 5.

FIG. 7 is a left side view thereof, based on FIG. 1.

FIG. 8 is a right side view thereof, and a reverse view of FIG. 7.

FIG. 9 is a perspective, exploded view of a peep hole cover of our invention.

FIG. 10 is a front view of a peep hole cover showing our new design, the only difference being the elliptical shape;

FIG. 11 is a front view of a peep hole cover showing our new design, the only difference being the octagonal shape;

FIG. 12 is a front view of a peep hole cover showing our new design, the only difference being the diamond shape;

FIG. 13 is a front view of a peep hole cover showing our new design, the only difference being the square shape; and,

FIG. 14 is a front view of a peep hole cover showing our new design, the only difference being the triangular shape.

The broken lines immediately adjacent the shaded areas represent bounds of the claimed design while all other broken lines depict environment that forms no part of the claimed design.

1 Claim, 5 Drawing Sheets

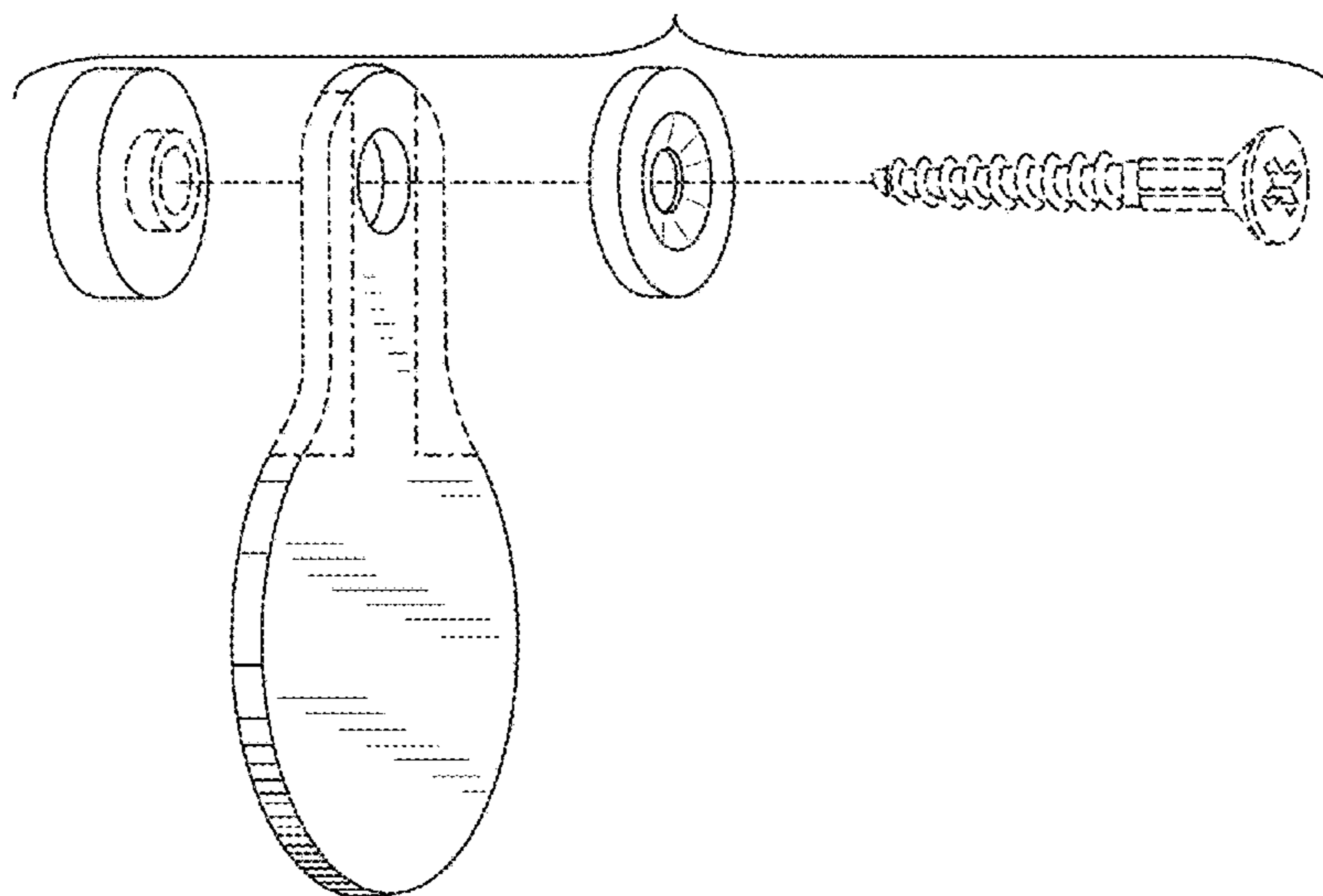

(56)

References Cited

U.S. PATENT DOCUMENTS

1,463,938	A	8/1923	Carter	
1,718,723	A	6/1929	Williams	
1,982,956	A	12/1934	Jacobi	
1,984,069	A	12/1934	Larter	
2,307,106	A	1/1943	Brush	
2,355,300	A	8/1944	Johnstone	
2,439,978	A	4/1948	Konchan	
D150,102	S	6/1948	Weinstein	
2,522,897	A	9/1950	Rotter	
2,632,252	A	3/1953	Blais, Sr.	
2,675,910	A	4/1954	Rasmussen et al.	
2,702,468	A	2/1955	Spain	
3,180,473	A	4/1965	Garvey	
3,343,384	A	9/1967	Barr	
3,564,744	A	2/1971	Shook	
4,581,834	A	4/1986	Zatkos et al.	
4,809,320	A	2/1989	Hawkins et al.	
4,909,617	A	3/1990	Boyd	
D363,248	S *	10/1995	Bogacki, III D10/109.1
5,667,515	A	9/1997	Chu	
D585,497	S *	1/2009	Williams, Jr. D20/22
D636,028	S *	4/2011	Widener D20/22
D706,327	S *	6/2014	Warr D16/130
D712,944	S *	9/2014	Warr D16/130
2007/0294928	A1 *	12/2007	Williams, Jr. G09F 3/0288 40/638

* cited by examiner

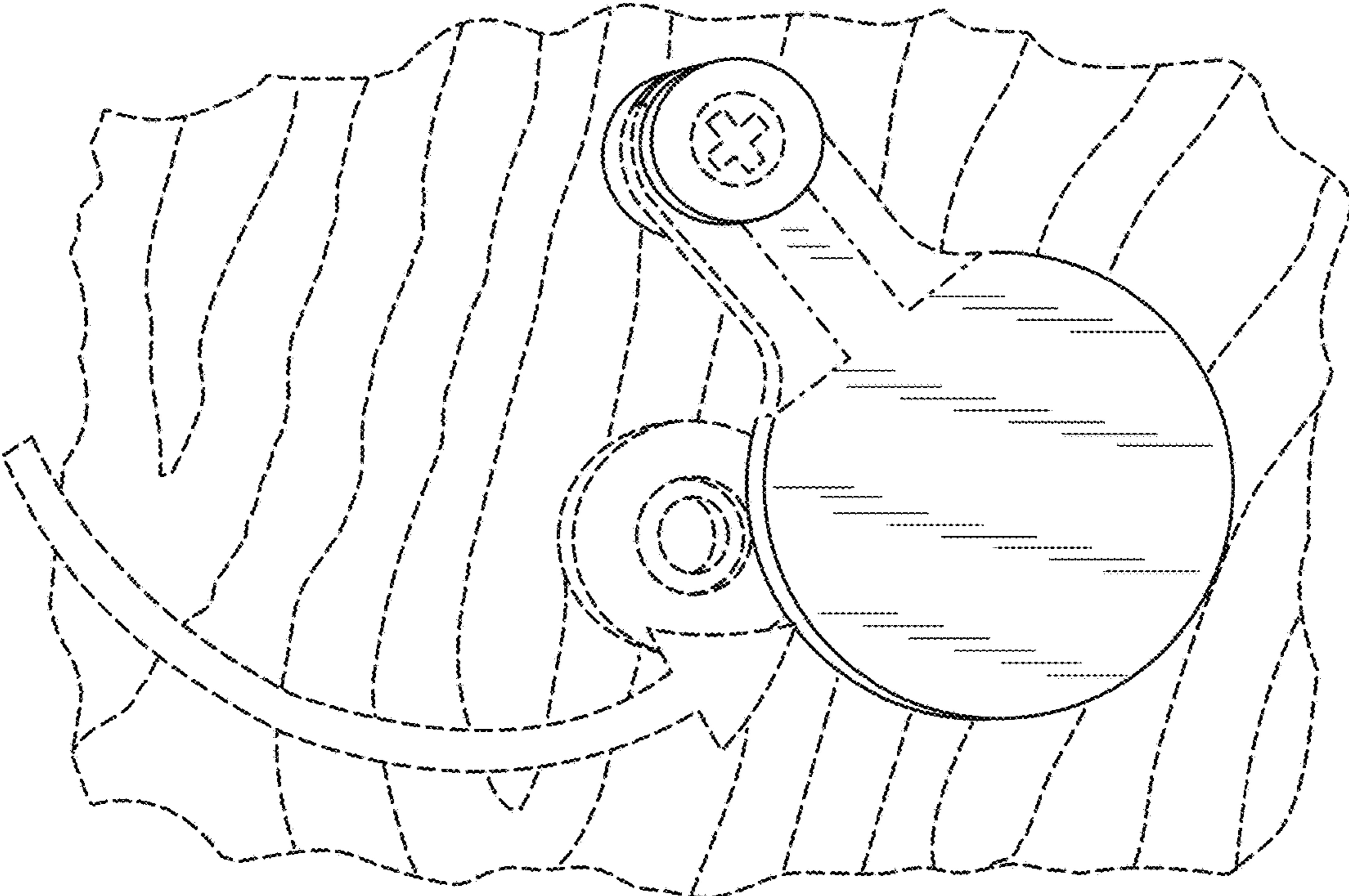

FIG. 1

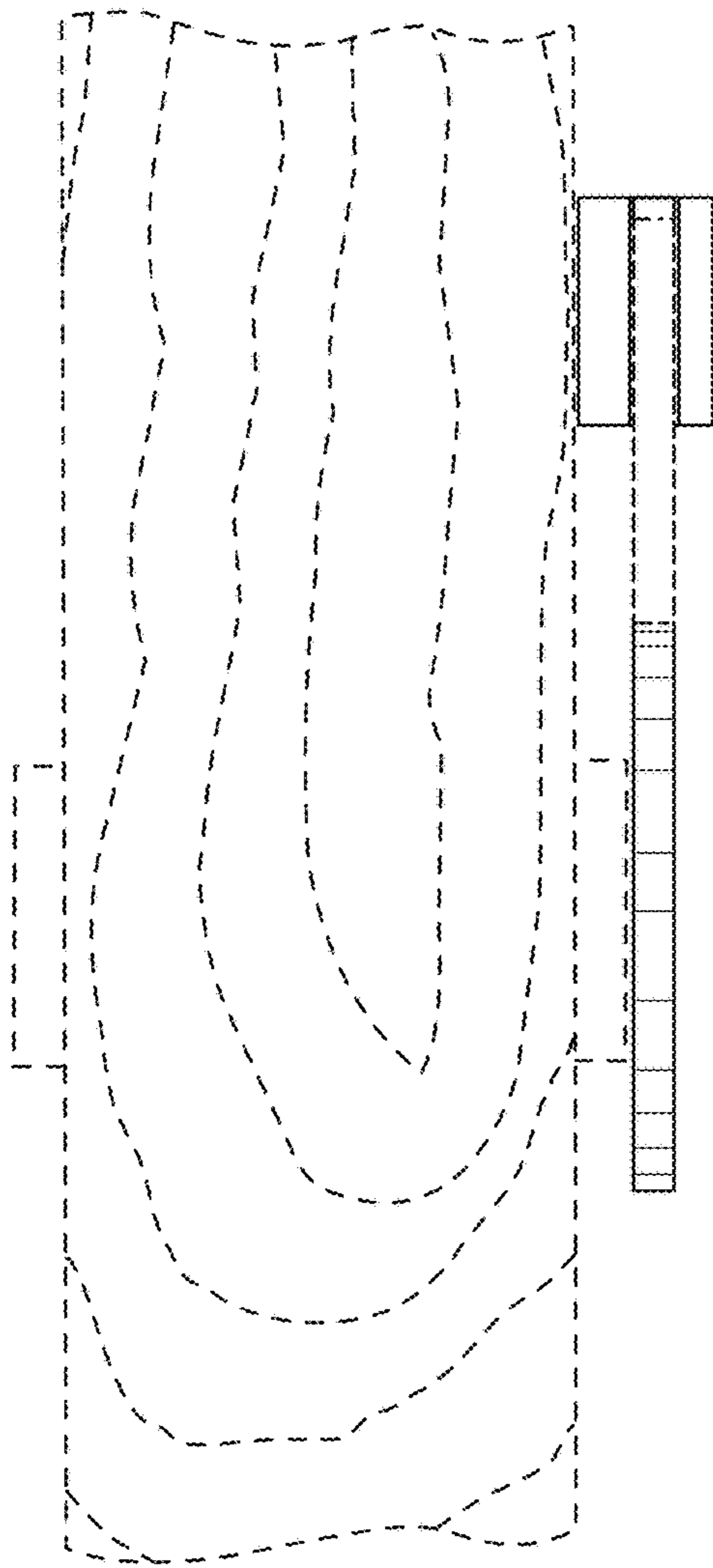

FIG. 2

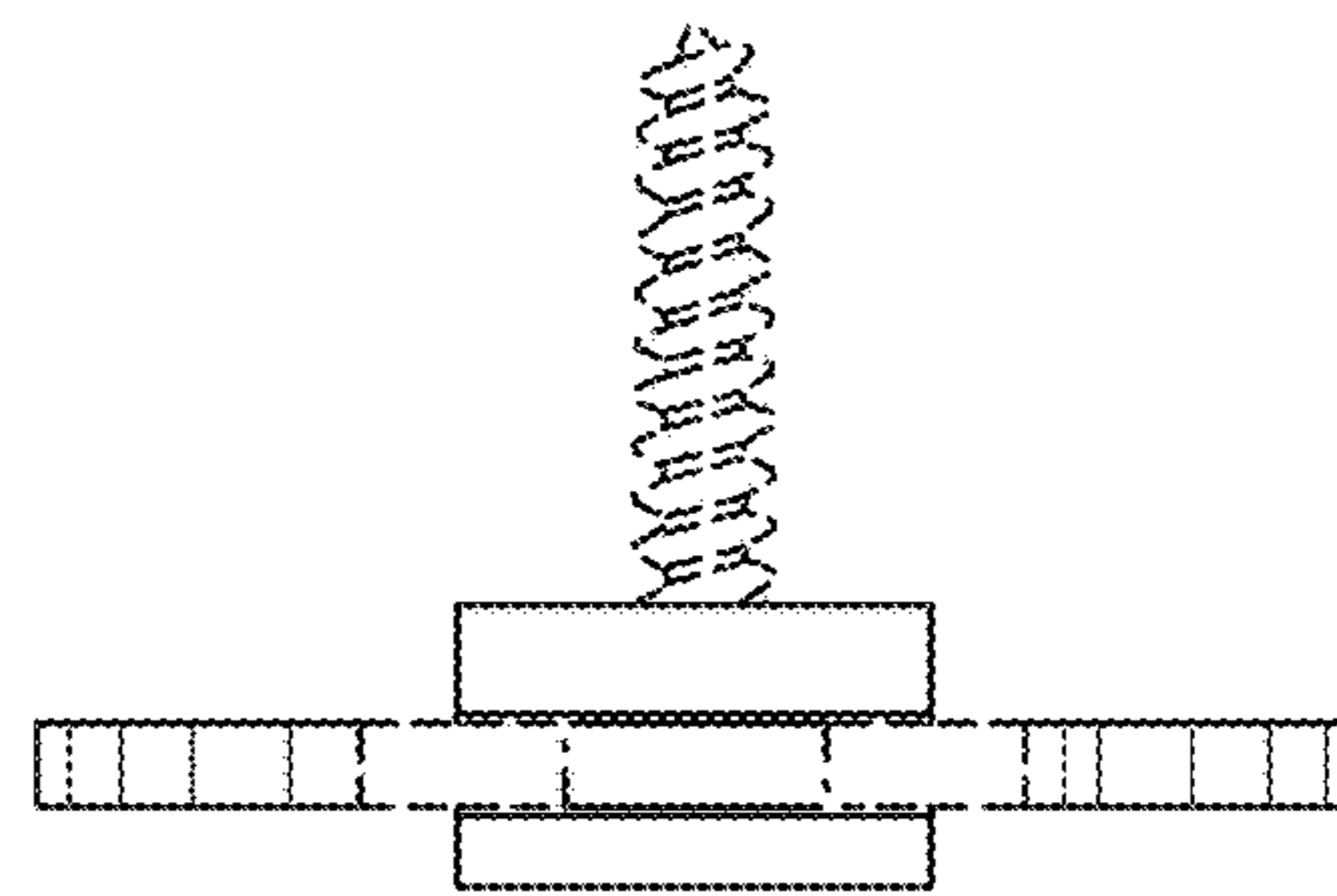

FIG. 3

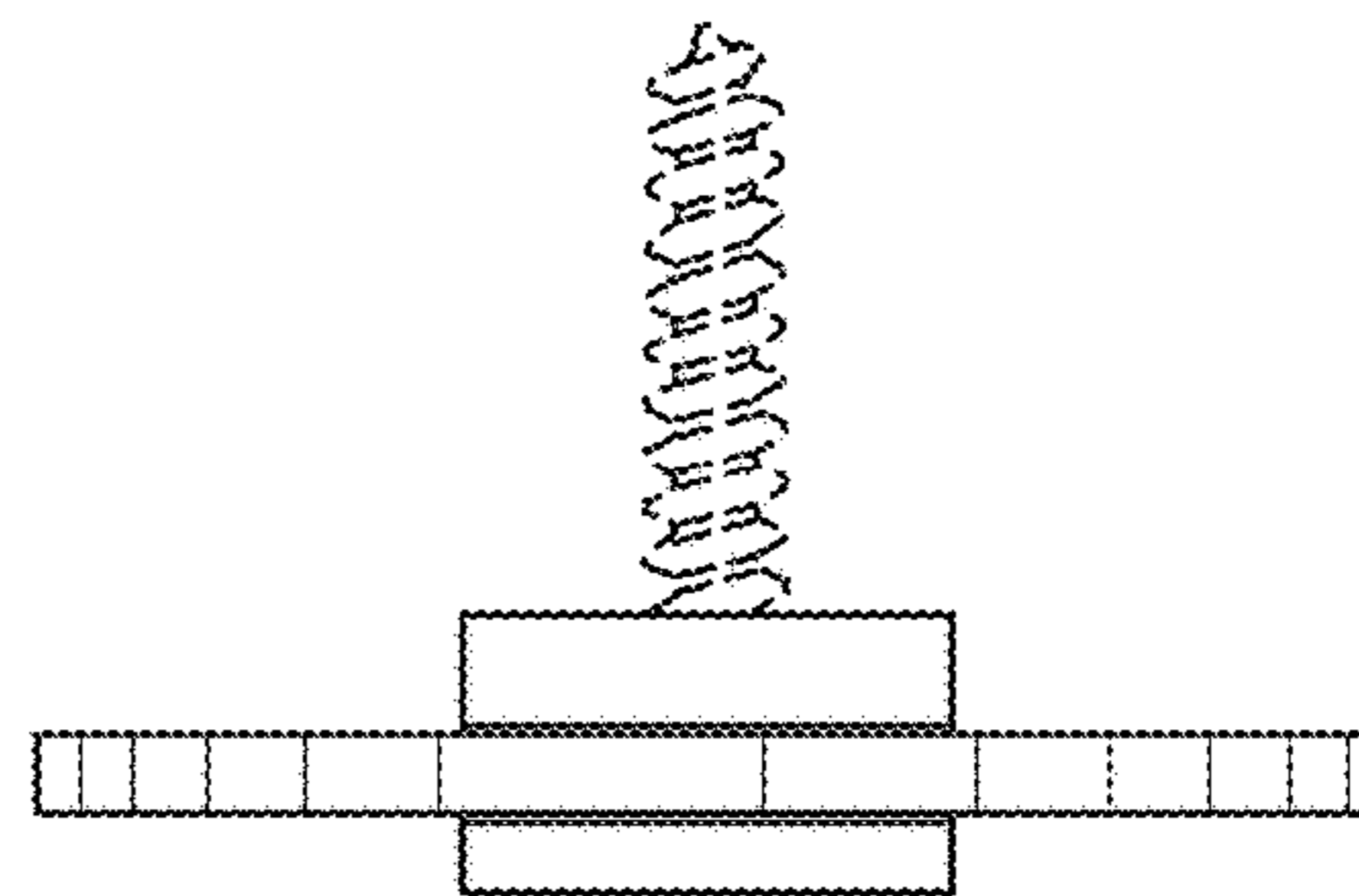

FIG. 4

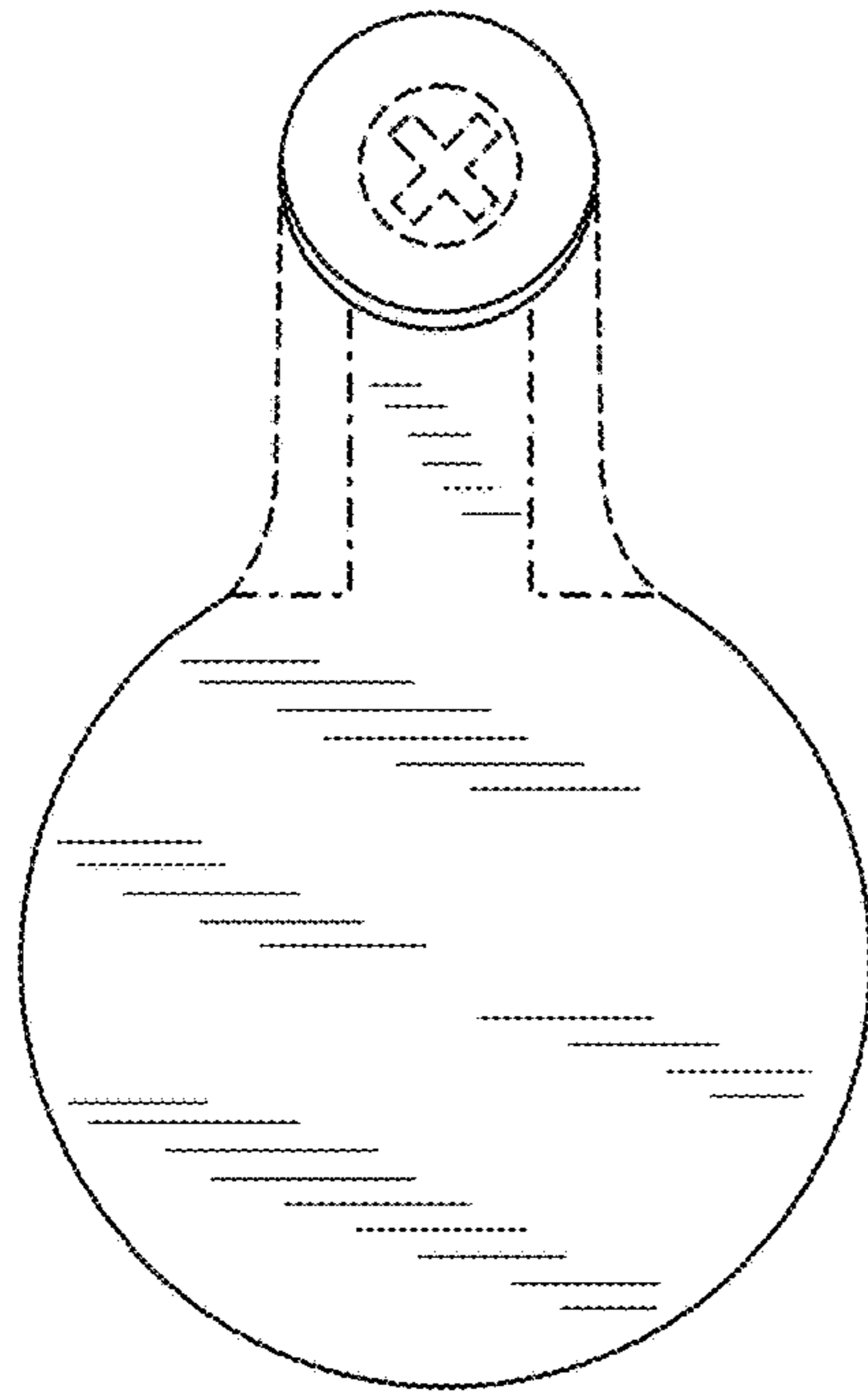

FIG. 5

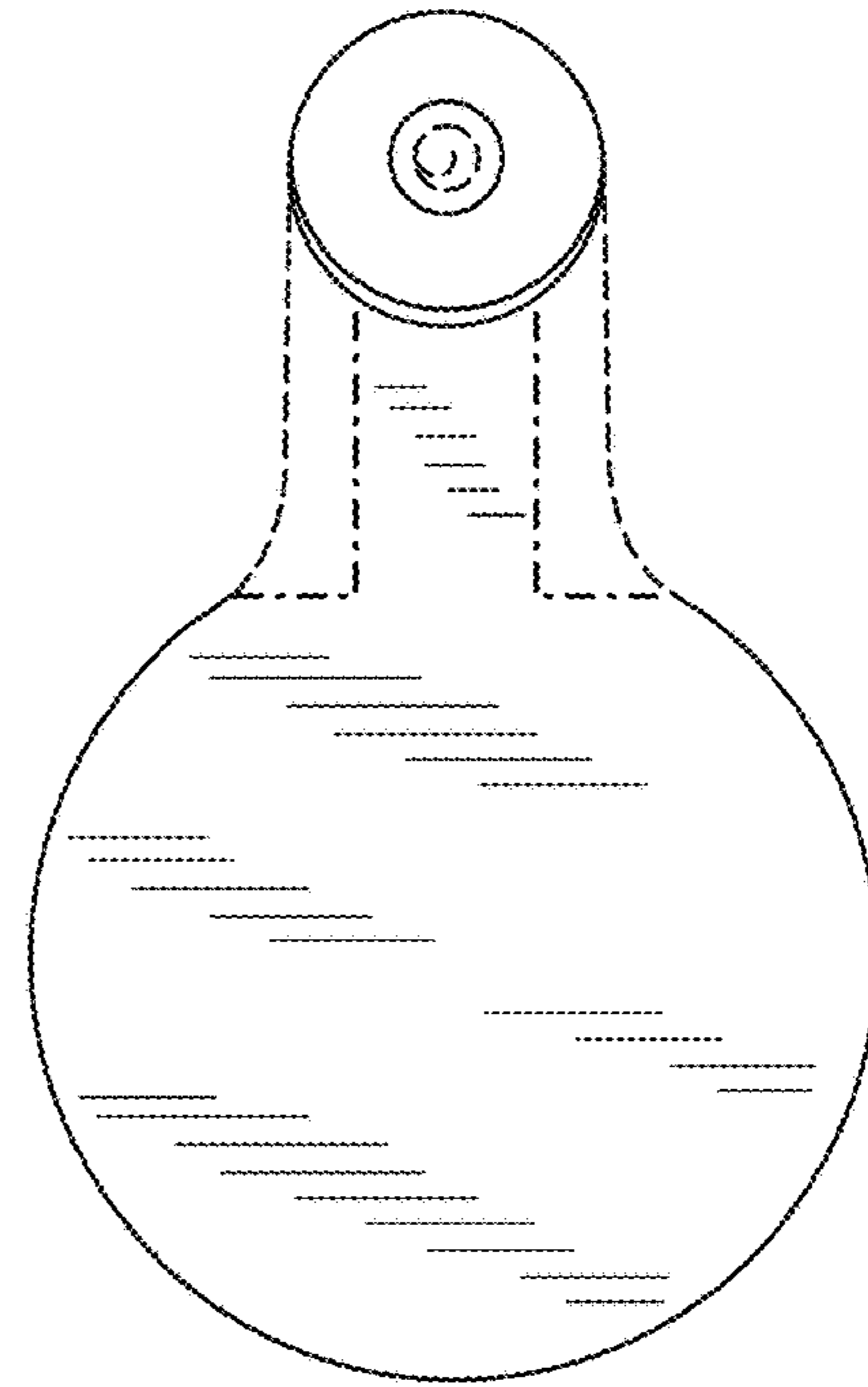

FIG. 6

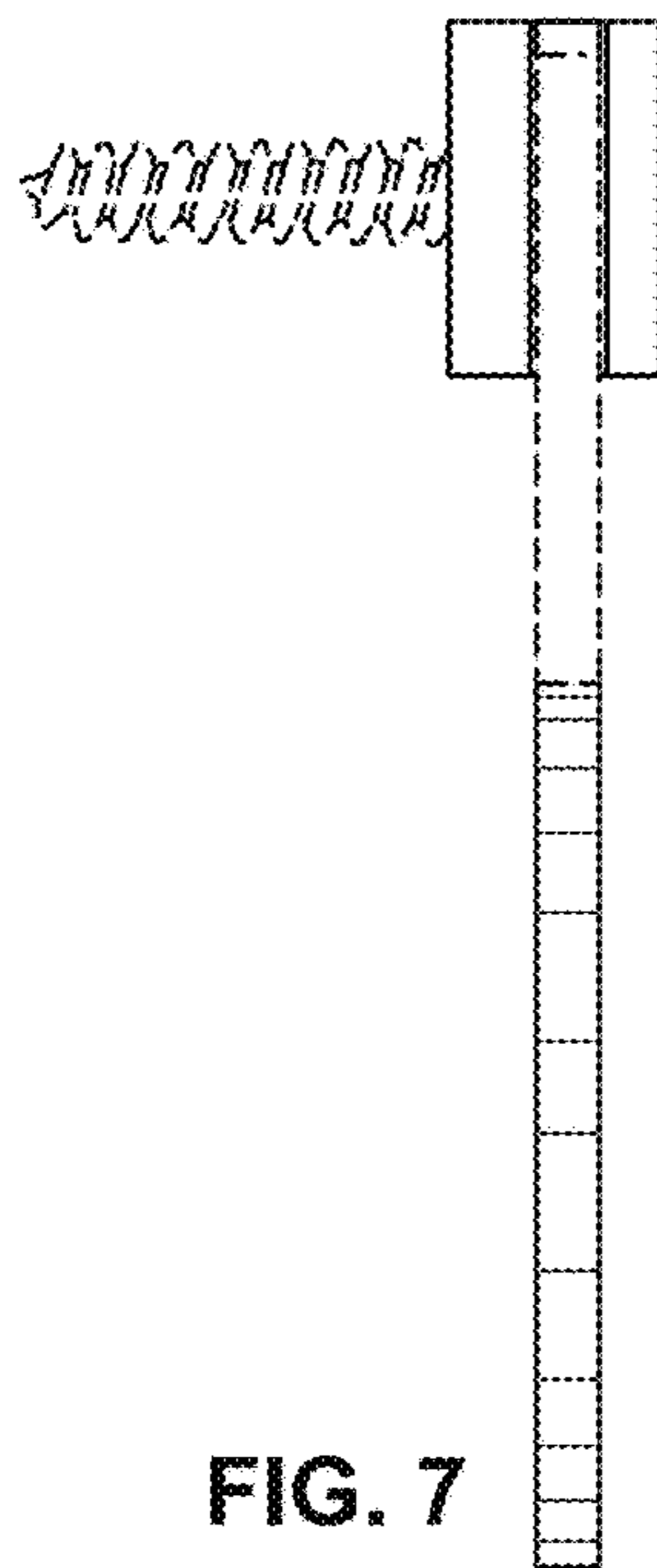

FIG. 7

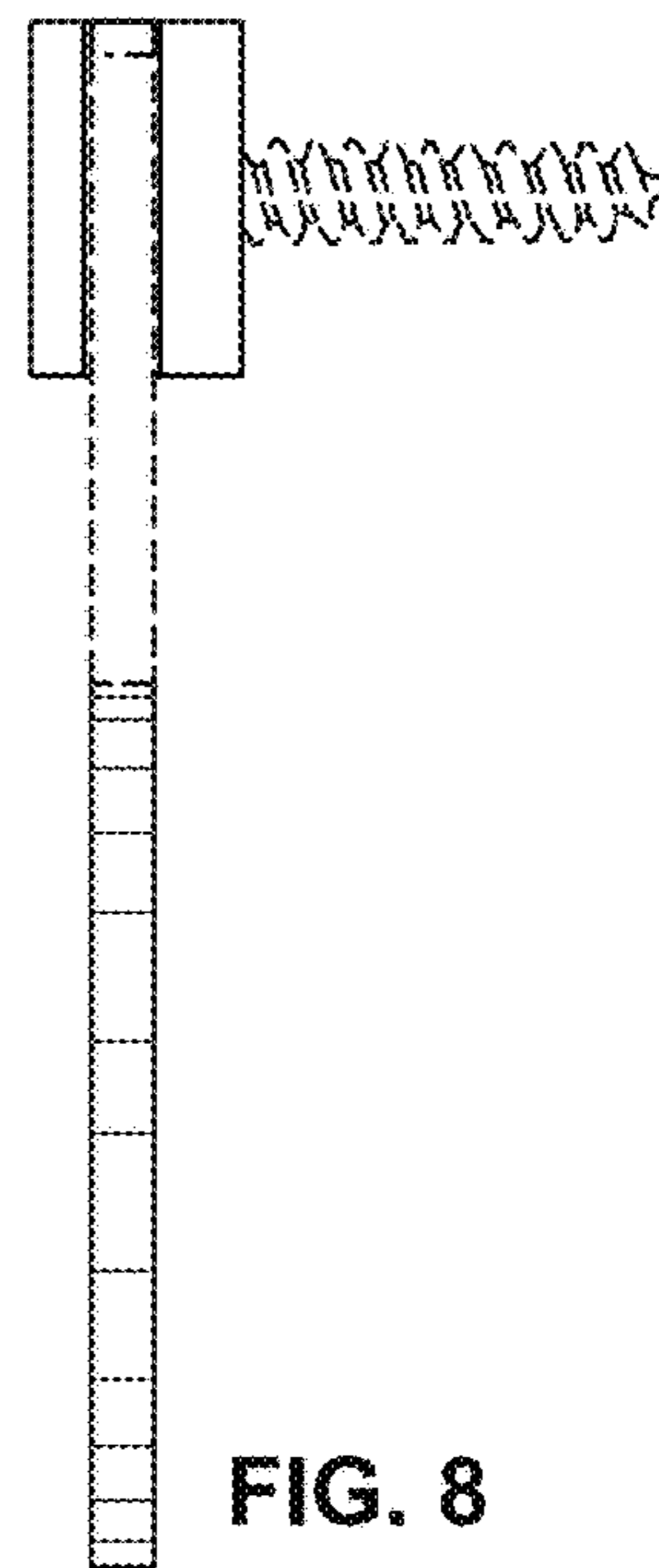
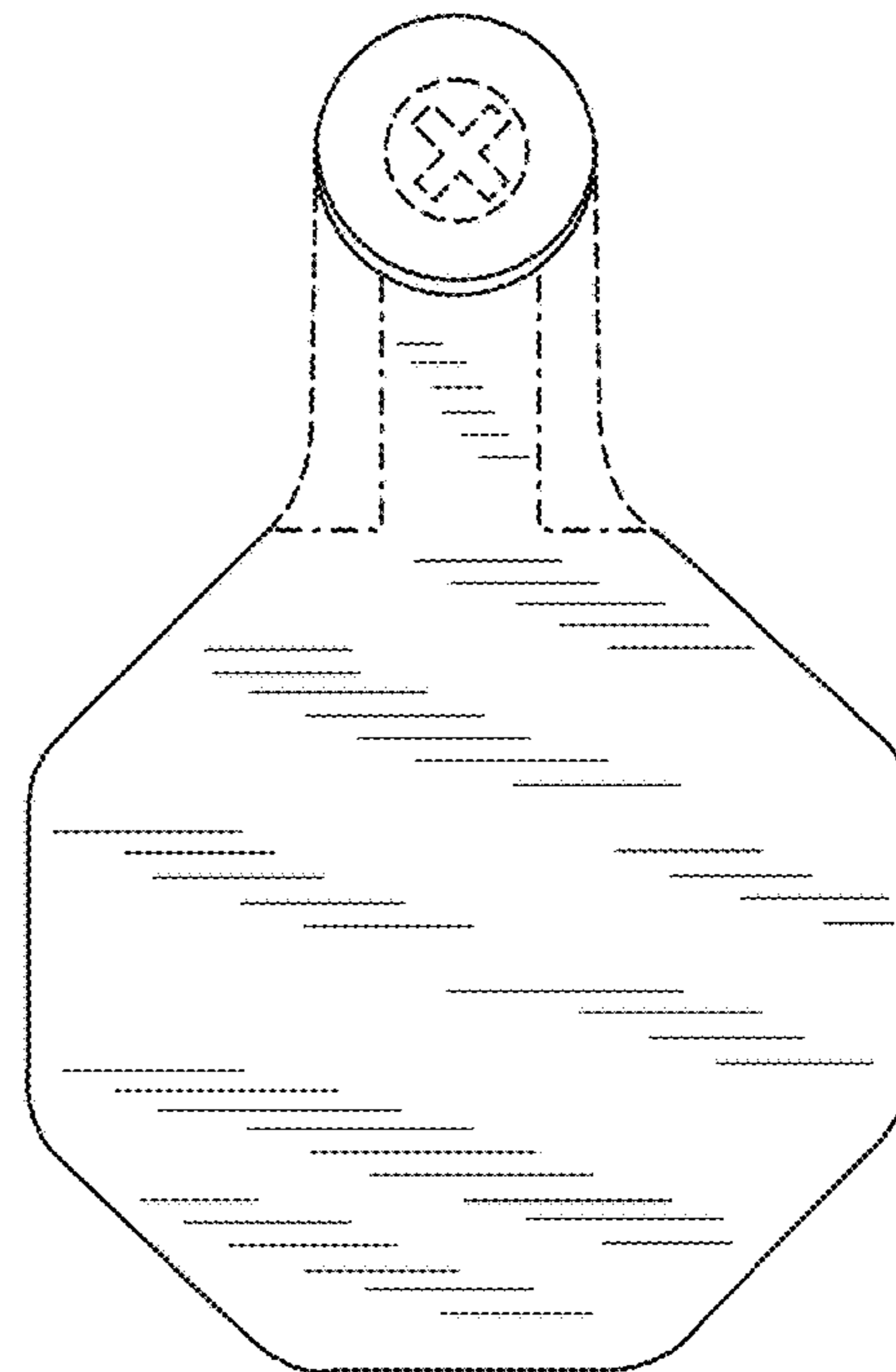
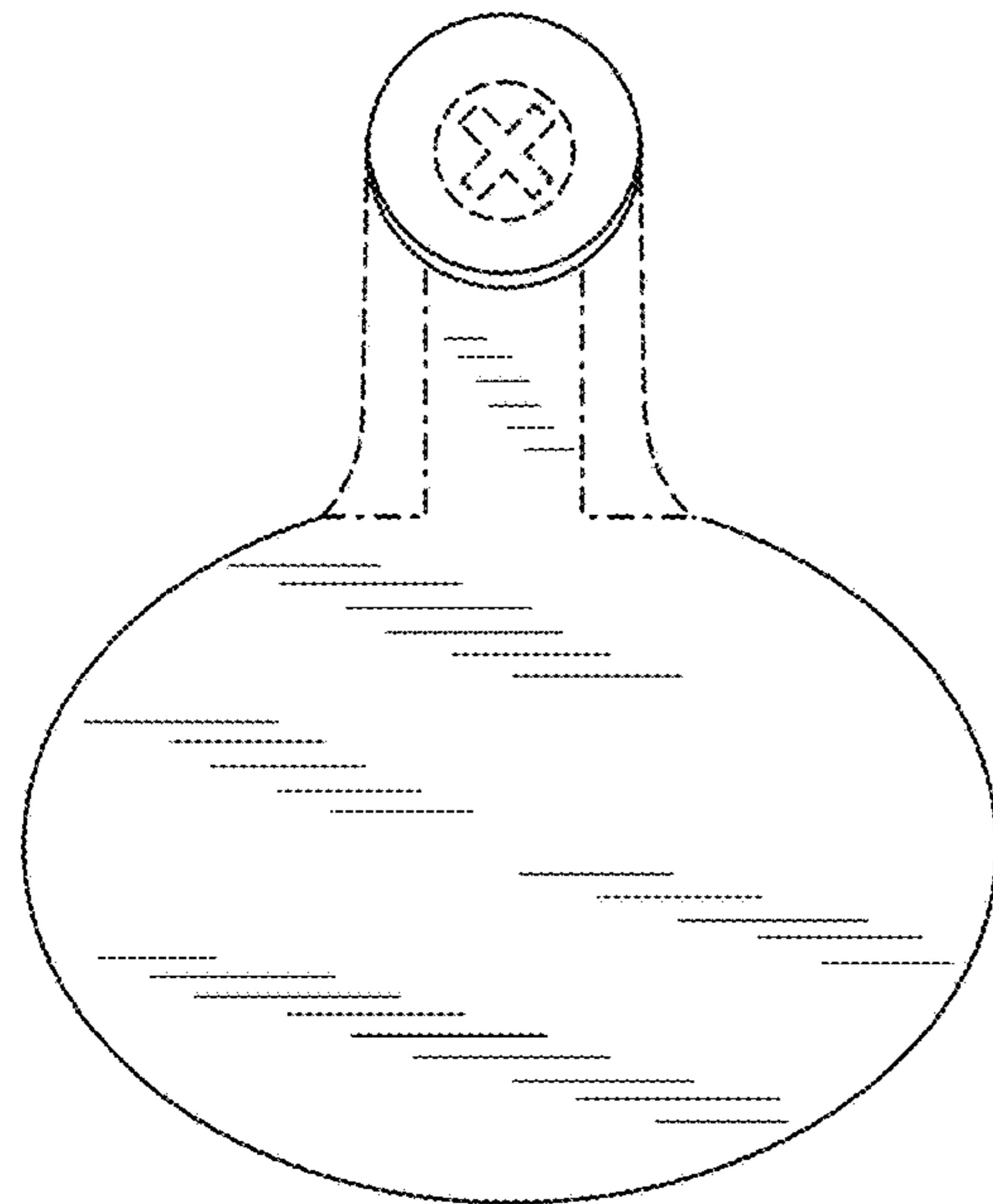
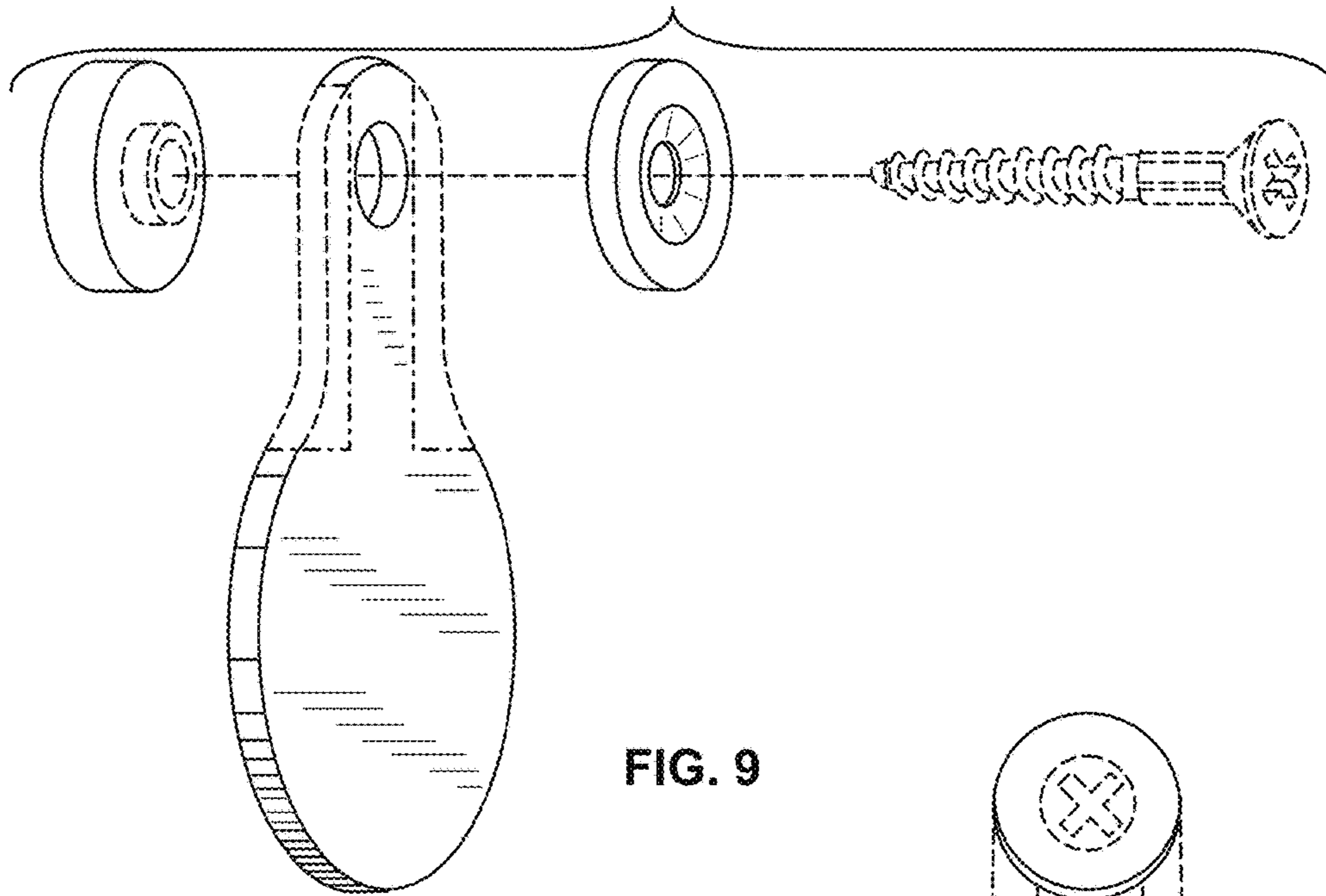

FIG. 8



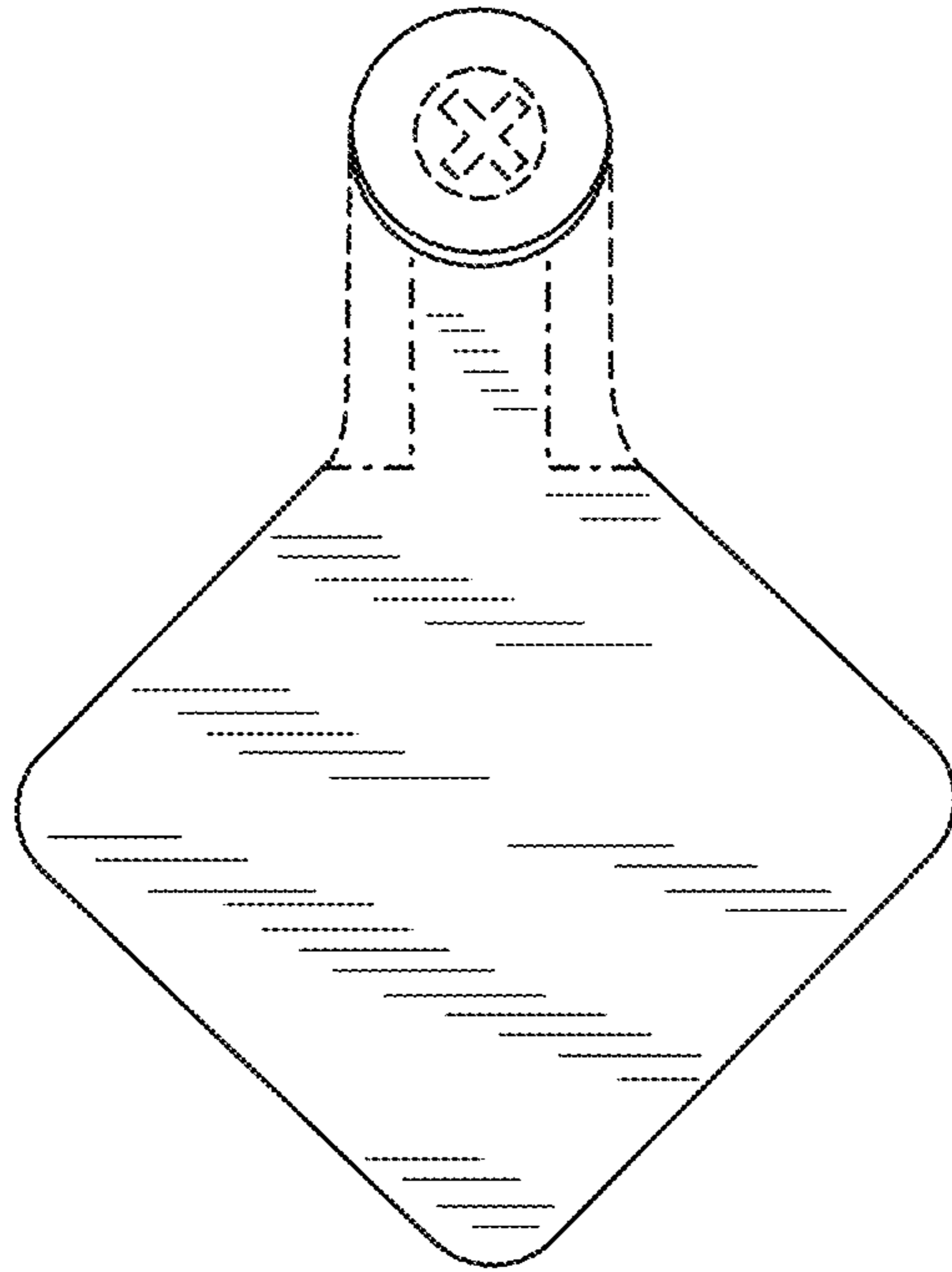

FIG. 12

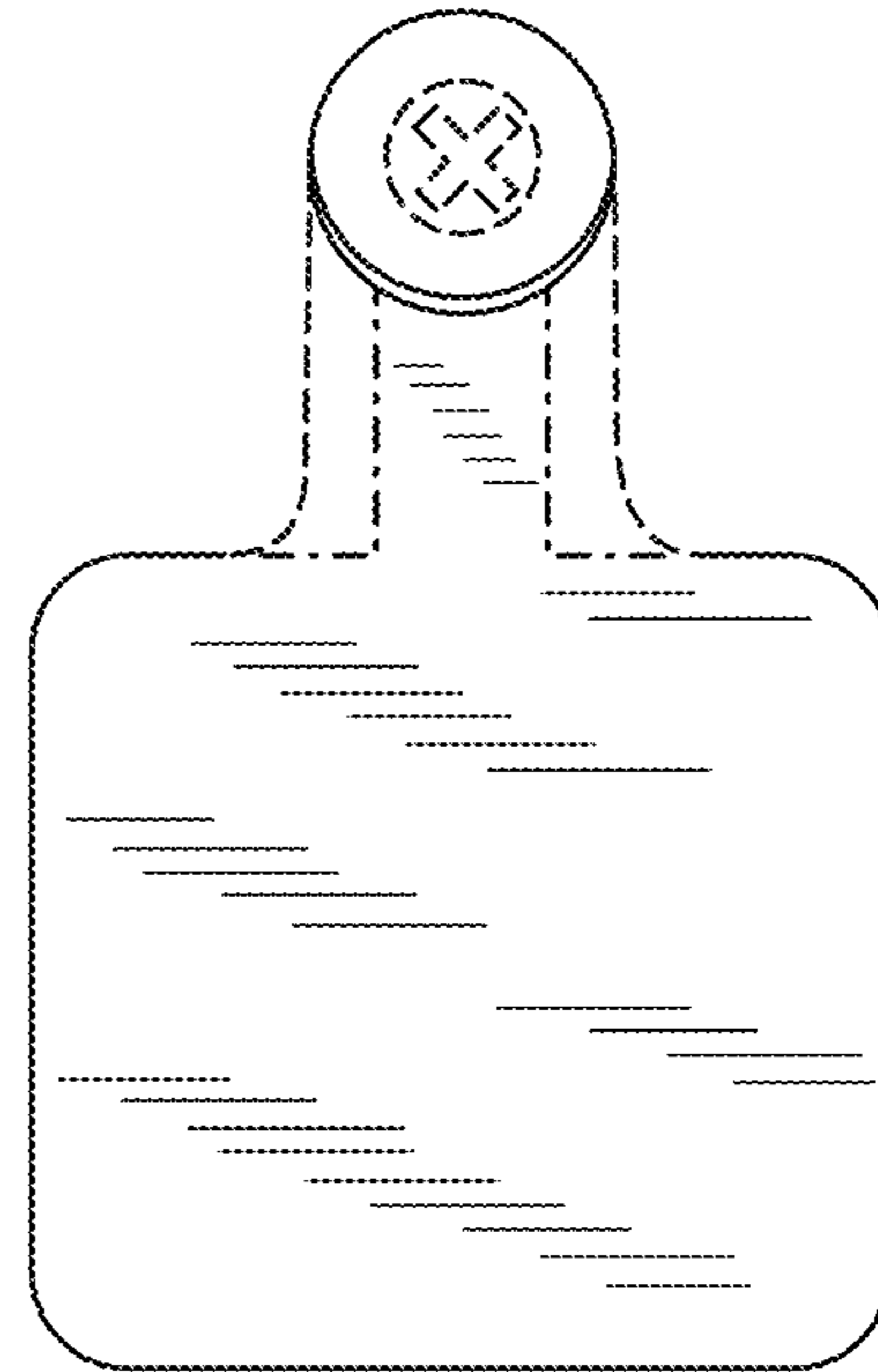

FIG. 13

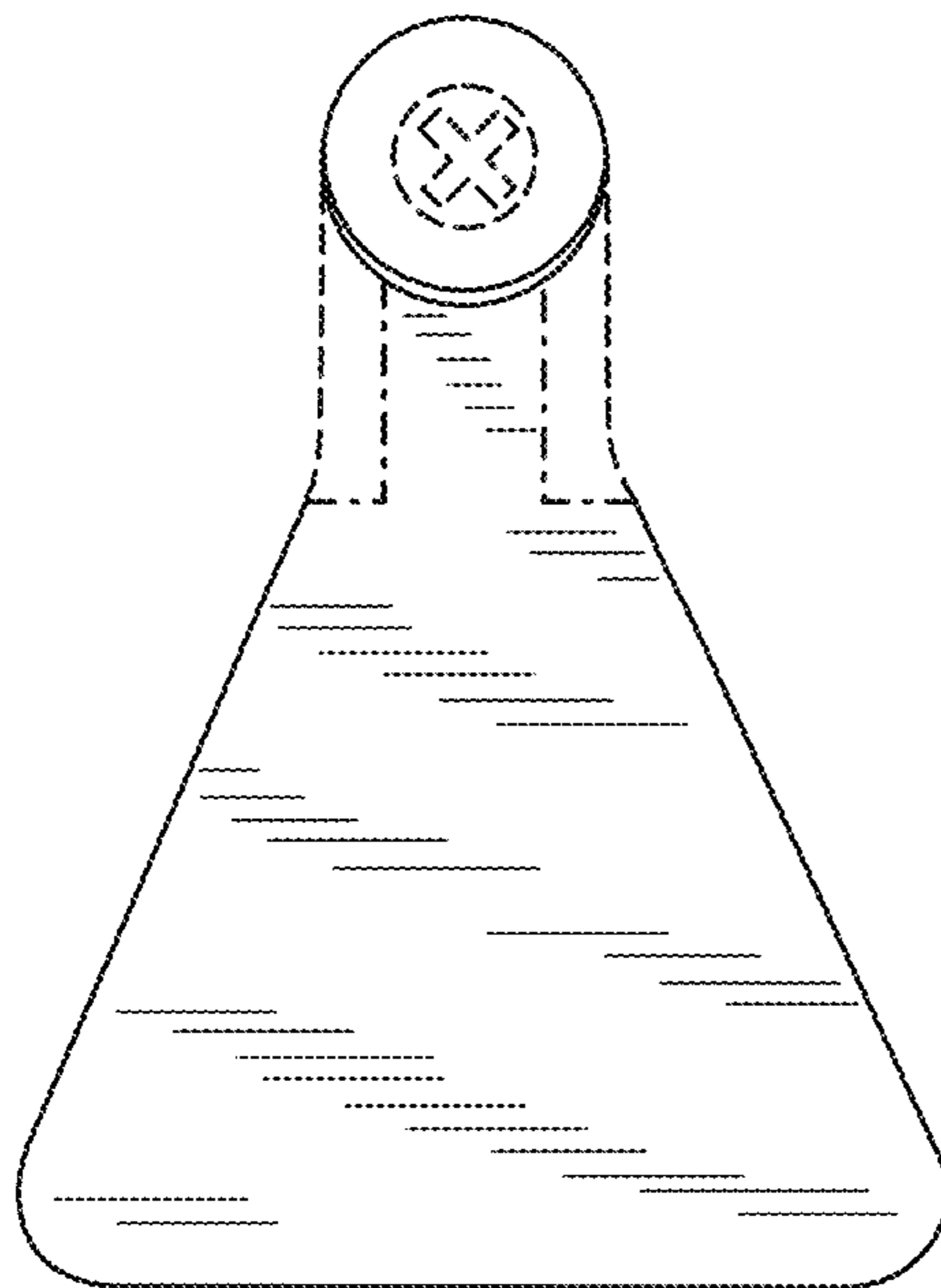

FIG. 14