



US00D807928S

(12) **United States Design Patent**
Kim

(10) **Patent No.:** **US D807,928 S**
(45) **Date of Patent:** **** *Jan. 16, 2018**

(54) **REFRIGERATOR**
(71) Applicant: **SAMSUNG ELECTRONICS CO., LTD.**, Suwon-si, Gyeonggi-do (KR)
(72) Inventor: **Jeong-Min Kim**, Seoul (KR)
(73) Assignee: **SAMSUNG ELECTRONICS CO., LTD.**, Gyeonggi-Do (KR)

D495,722 S 9/2004 Avalos Barcenas et al.
D507,284 S * 7/2005 Seo D15/85
D538,310 S * 3/2007 Avalos Barcenas D15/91
D543,560 S 5/2007 Seum et al.
D673,187 S * 12/2012 Seo D15/85
D677,287 S * 3/2013 Ding D15/85
D677,288 S * 3/2013 Ma D15/85

(Continued)

(*) Notice: This patent is subject to a terminal disclaimer.
(**) Term: **15 Years**

FOREIGN PATENT DOCUMENTS
KR 300103318 S 5/1990
KR 300118454 S 8/1991
KR 300659300 S 9/2012

(21) Appl. No.: **29/585,969**
(22) Filed: **Nov. 30, 2016**
(30) **Foreign Application Priority Data**
Jun. 27, 2016 (KR) 30-2016-0031217

OTHER PUBLICATIONS
Summit FF1152SS 10.4 cu.ft. Counter . . . pp. 1-4 [online].
[retrieved on Sep. 23, 2015]. Retrieved from the Internet: <URL:
http://www.appliancewarehousecenter.com/Summit_FF1152SS_10_4_cu_ft_Counter_Depth_p/ff1152ss.htm.
(Continued)

(51) **LOC (11) Cl.** **15-07**
(52) **U.S. Cl.**
USPC **D15/81**
(58) **Field of Classification Search**
USPC D15/79-91
CPC F25D 29/00; F25D 11/003; F25D 2700/08;
F25D 11/02; F25D 11/022; F25D 13/06;
F25D 19/006; F25D 2201/14; F25D
2323/00261; F25D 2323/00262; F25D
2323/00272; F25D 2400/361; F25D
2500/06; F25D 2700/02; F25D 2700/12;
F25D 29/005; F25D 29/008; F25D
31/002; F25C 29/00; F25C 11/003; F25C
13/06; F25C 19/006; F25C 31/002
See application file for complete search history.

Primary Examiner — Ian Simmons
Assistant Examiner — Khawaja Anwar
(74) *Attorney, Agent, or Firm* — Cantor Colburn LLP

(57) **CLAIM**
The ornamental design for a refrigerator, as shown and described.

(56) **References Cited**
U.S. PATENT DOCUMENTS
1,961,022 A 5/1934 Teller et al.
D452,255 S 12/2001 Chai et al.
D491,960 S * 6/2004 Kang D15/85

DESCRIPTION
FIG. 1 is a perspective view of a refrigerator, showing my design;
FIG. 2 is a front view thereof;
FIG. 3 is a rear view thereof;
FIG. 4 is a side view thereof;
FIG. 5 is another side view thereof;
FIG. 6 is a top view thereof; and,
FIG. 7 is a bottom view thereof.
The broken lines illustrating portions of the refrigerator form no part of the claimed design.

1 Claim, 7 Drawing Sheets

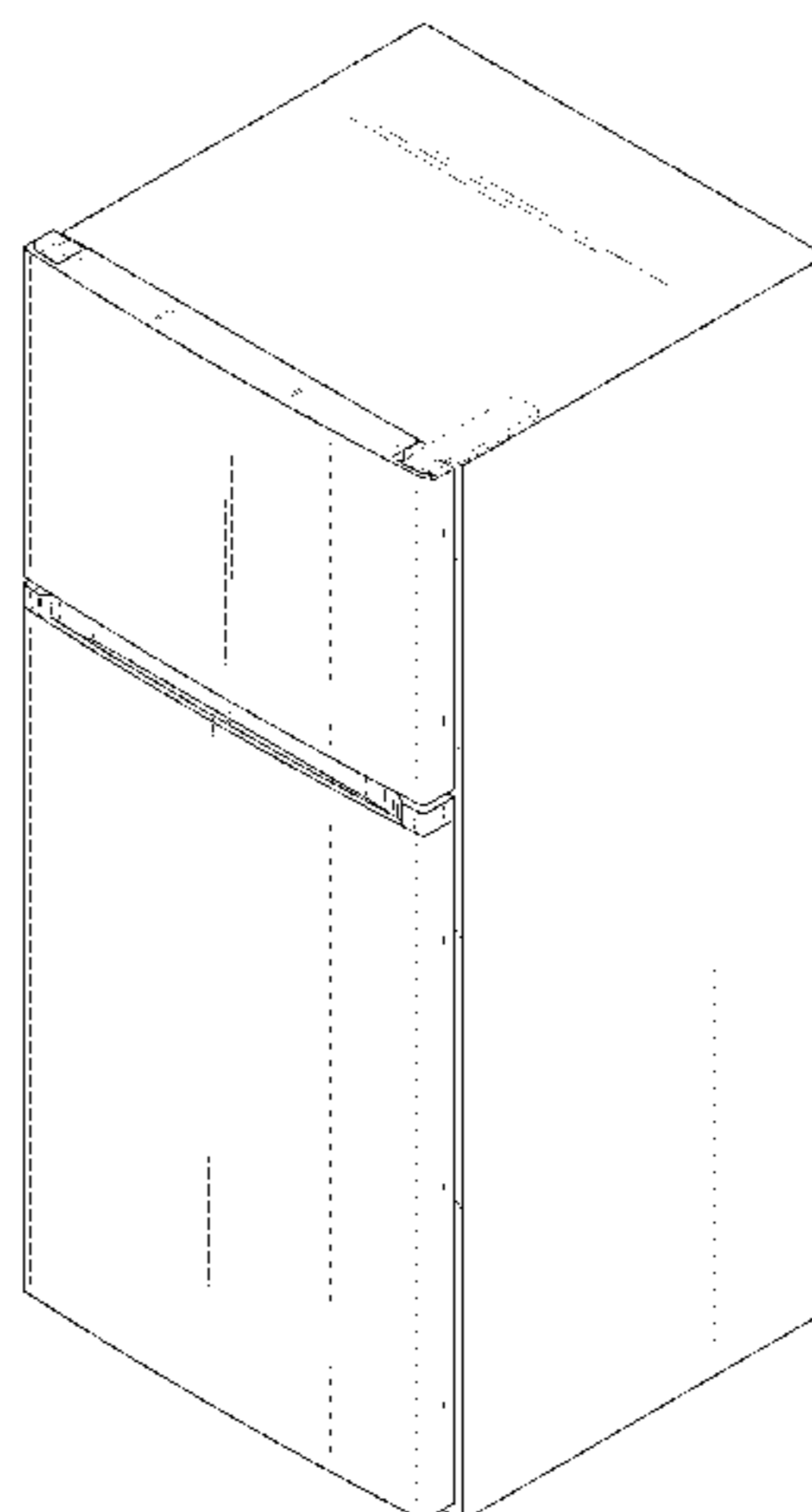

(56)

References Cited

U.S. PATENT DOCUMENTS

D684,199 S * 6/2013 Jeon D15/86
D725,686 S * 3/2015 Cho D15/85

OTHER PUBLICATIONS

Whirlpool NEO IC255 CLS Plus . . . [online] pp. 1-4. [retrieved on
Sep. 23, 2015]. Retrieved from the Internet: <URL:http://www.
userreviewd.com/home-appliances/whirlpool-neo-ic255-cls-plus-
3-242-I-double-door-refrigerator.

* cited by examiner

FIG. 1

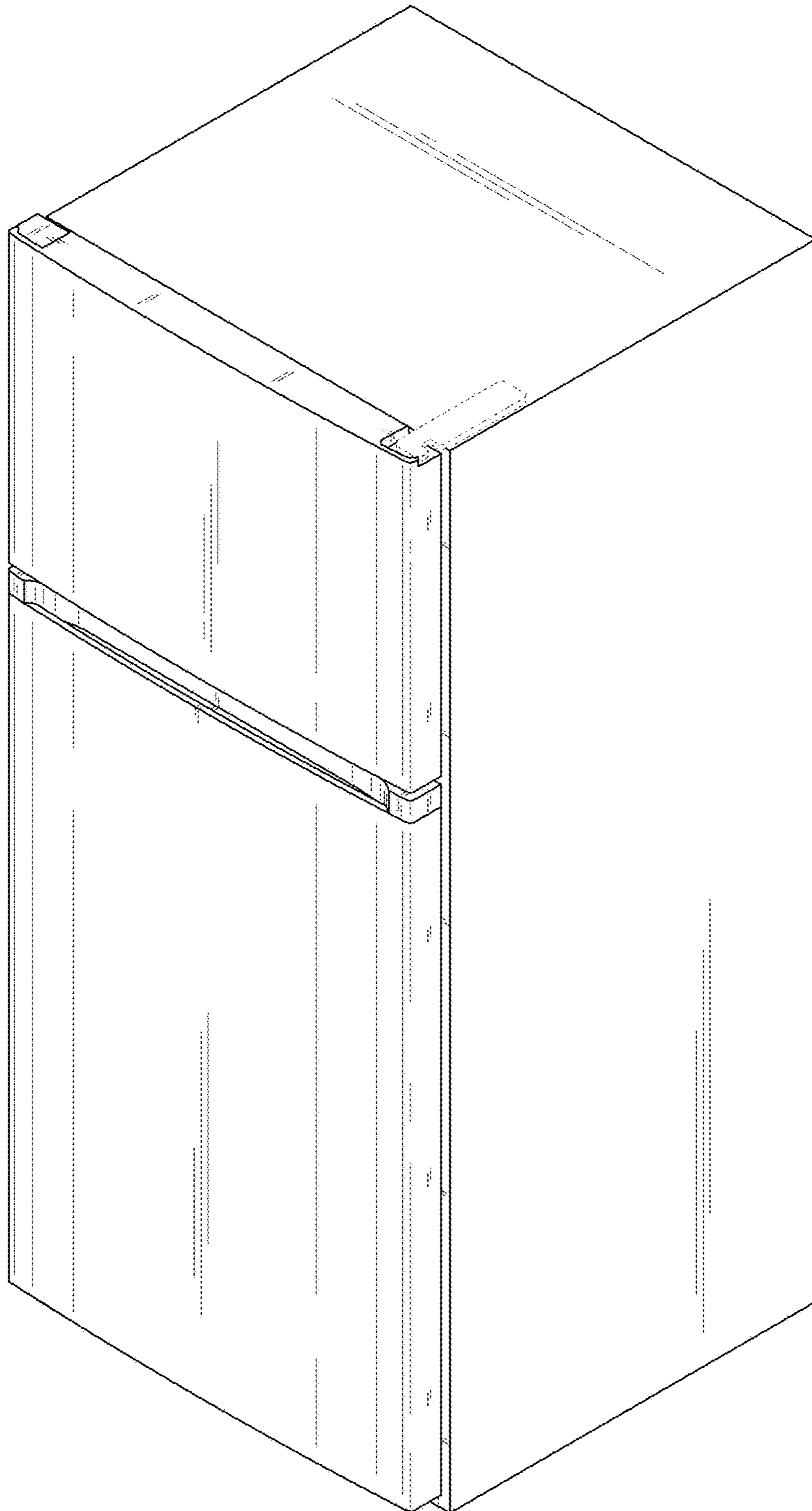

FIG. 2

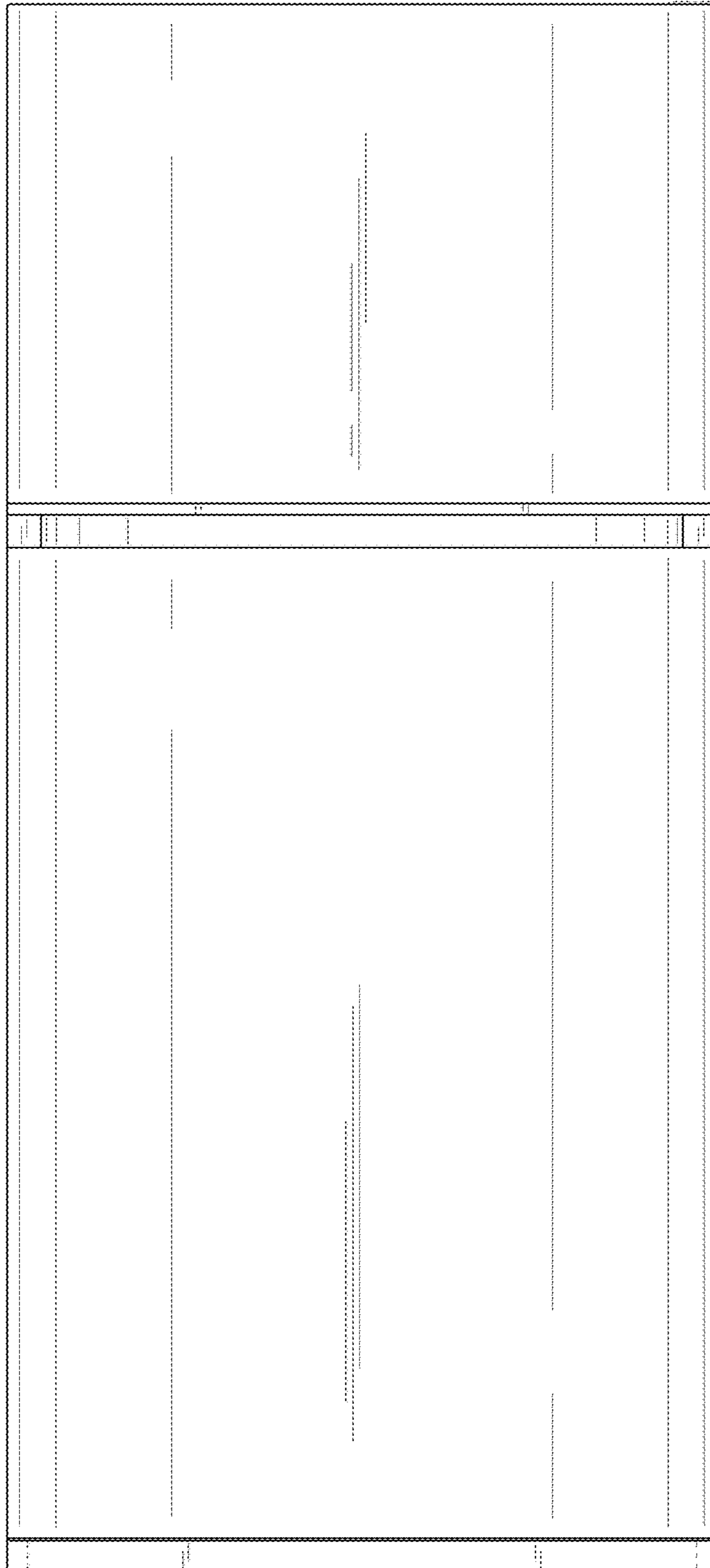

FIG. 3

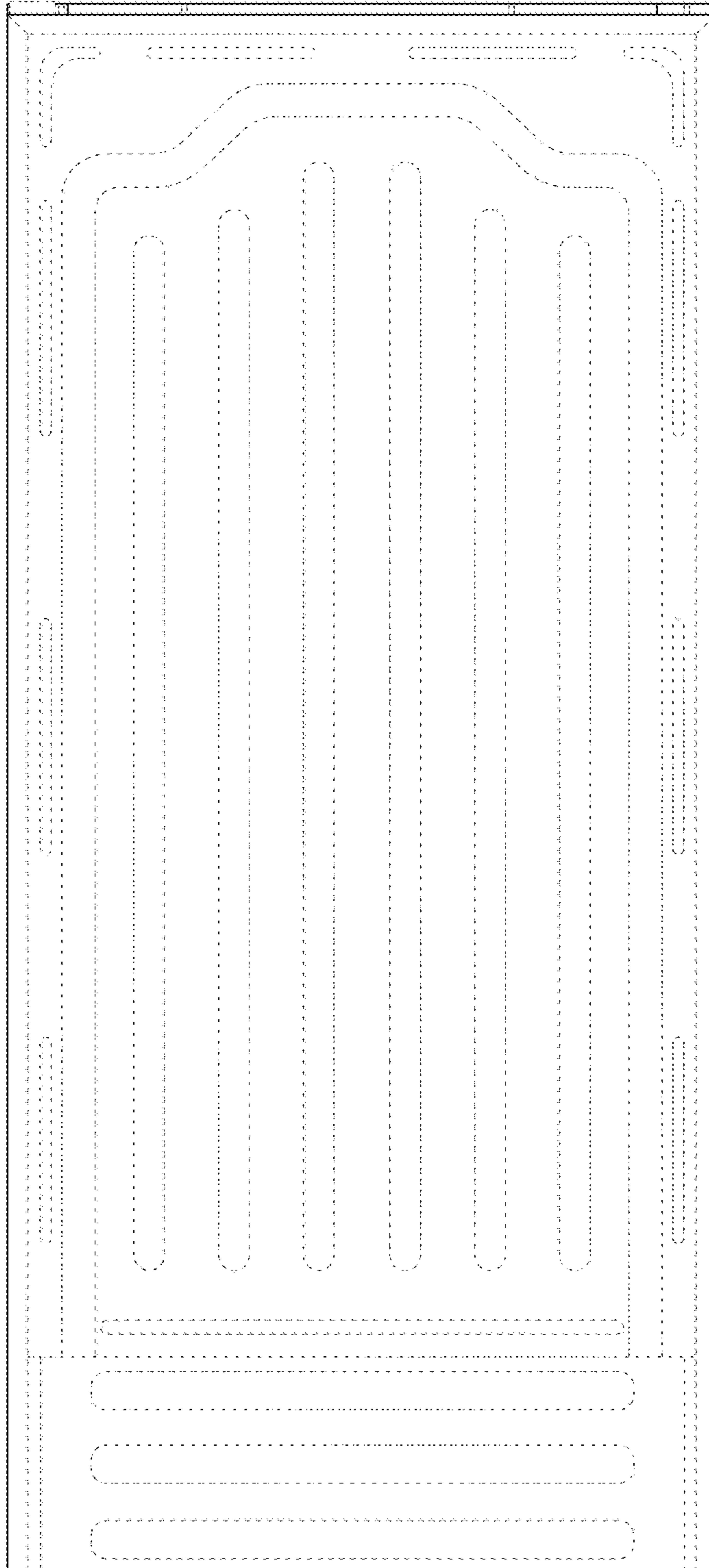

FIG. 4

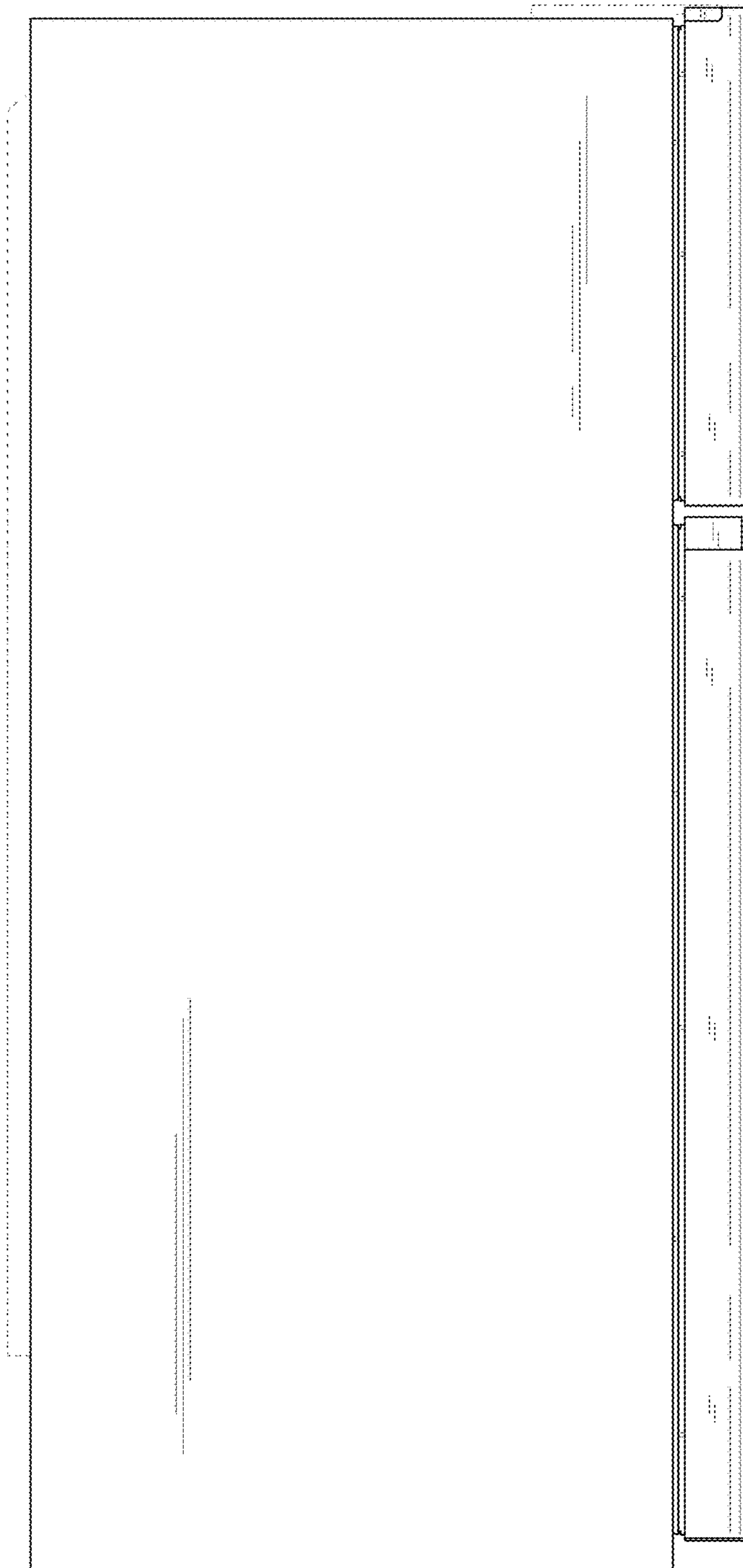

FIG. 5

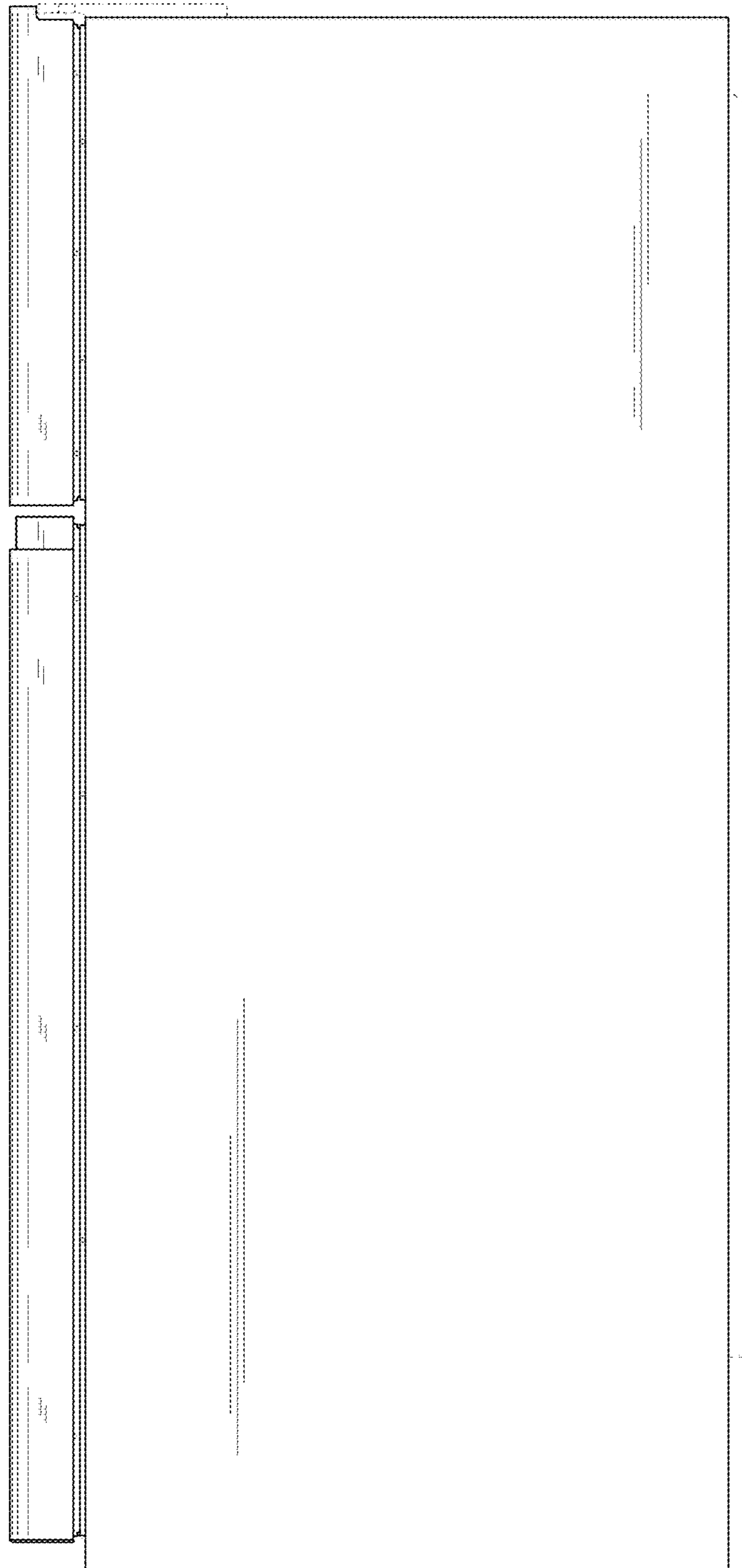

FIG. 6

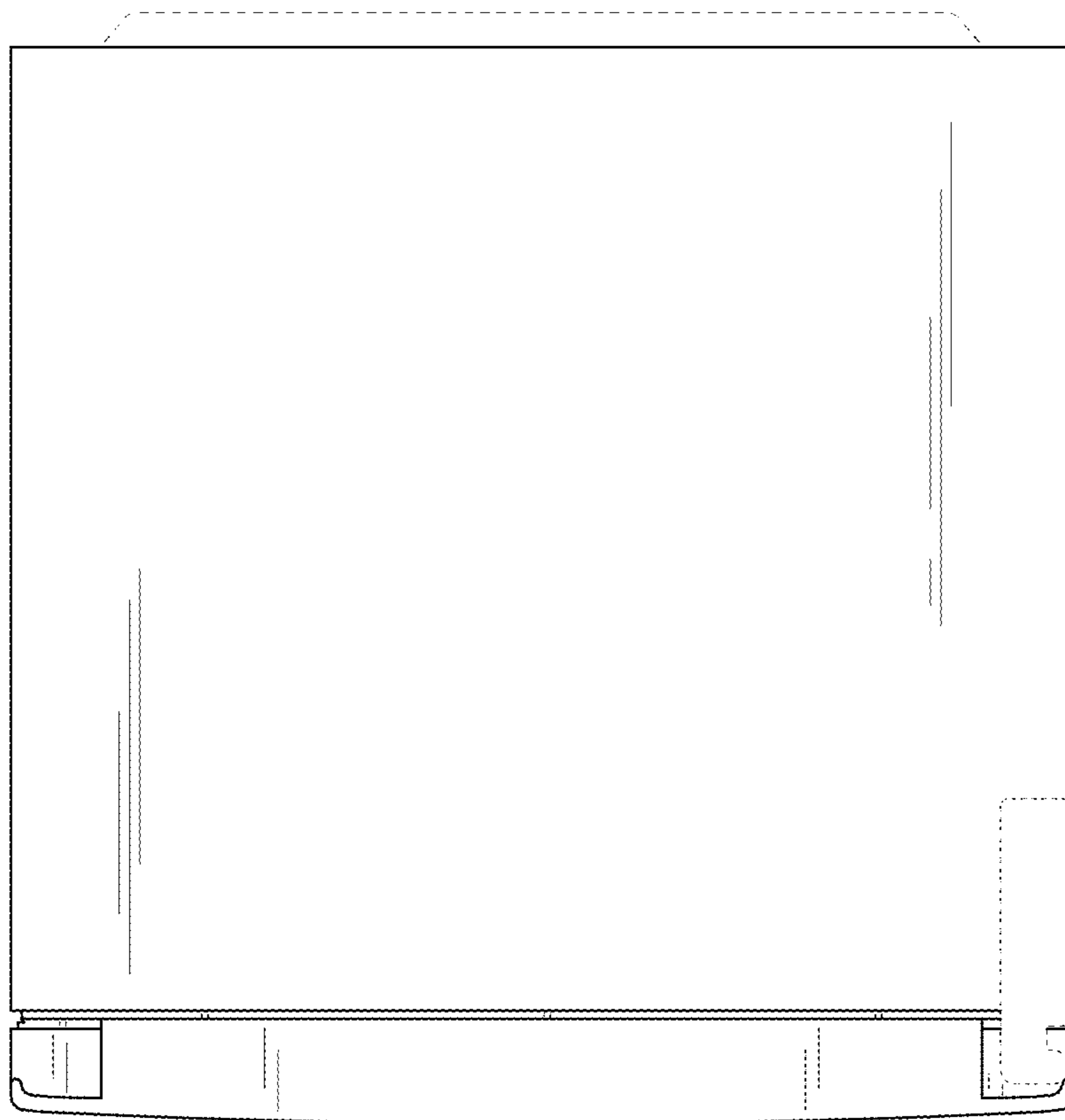

FIG. 7

