



US00D807871S

(12) **United States Design Patent**  
**Wellard**

(10) **Patent No.:** **US D807,871 S**

(45) **Date of Patent:** **\*\* Jan. 16, 2018**

(54) **AUTO STEREO MOUNTING DEVICE**

(71) Applicant: **Metra Electronics Corporation**, Holly Hill, FL (US)

(72) Inventor: **Kennesaw Wellard**, Holly Hill, FL (US)

(73) Assignee: **Metra Electronics Corporation**, Holly Hill, FL (US)

(\*\*) Term: **15 Years**

(21) Appl. No.: **29/563,811**

(22) Filed: **May 9, 2016**

(51) **LOC (11) Cl.** ..... **14-03**

(52) **U.S. Cl.**  
USPC ..... **D14/258**

(58) **Field of Classification Search**  
USPC ..... D12/192, 195, 415, 420; D14/496, D14/498-506, 154, 157, 168-171, D14/188-198, 257-258; 248/27.1, 27.3, 248/558; 455/347, 350  
CPC ..... B60R 11/02; B60K 37/04; B60K 37/06; H04B 1/08; H04B 1/082  
See application file for complete search history.

(56) **References Cited**

**U.S. PATENT DOCUMENTS**

D435,818 S \* 1/2001 Shimizu ..... D12/192  
D449,026 S \* 10/2001 Tsay ..... D12/192

D578,048 S \* 10/2008 Wyszogrod ..... D12/192  
D579,390 S \* 10/2008 Wyszogrod ..... D12/192  
D727,887 S \* 4/2015 Fiore, IV ..... D12/192  
D727,889 S \* 4/2015 Fiore, IV ..... D12/192

\* cited by examiner

*Primary Examiner* — Sandra L Morris

(74) *Attorney, Agent, or Firm* — J. Wiley Horton

(57) **CLAIM**

The ornamental design for an “auto stereo mounting device,” as shown and described.

**DESCRIPTION**

FIG. 1 is a perspective view of an auto stereo mounting device, showing my design;  
FIG. 2 is a front elevation view of FIG. 1;  
FIG. 3 is a rear elevation view of FIG. 1;  
FIG. 4 is a right side elevation view of FIG. 1;  
FIG. 5 is a left side elevation view of FIG. 1;  
FIG. 6 is a top plan view of FIG. 1; and,  
FIG. 7 is a bottom plan view of FIG. 1.  
The broken lines shown in all views illustrate mounting features which form no part of the claimed design.

**1 Claim, 7 Drawing Sheets**

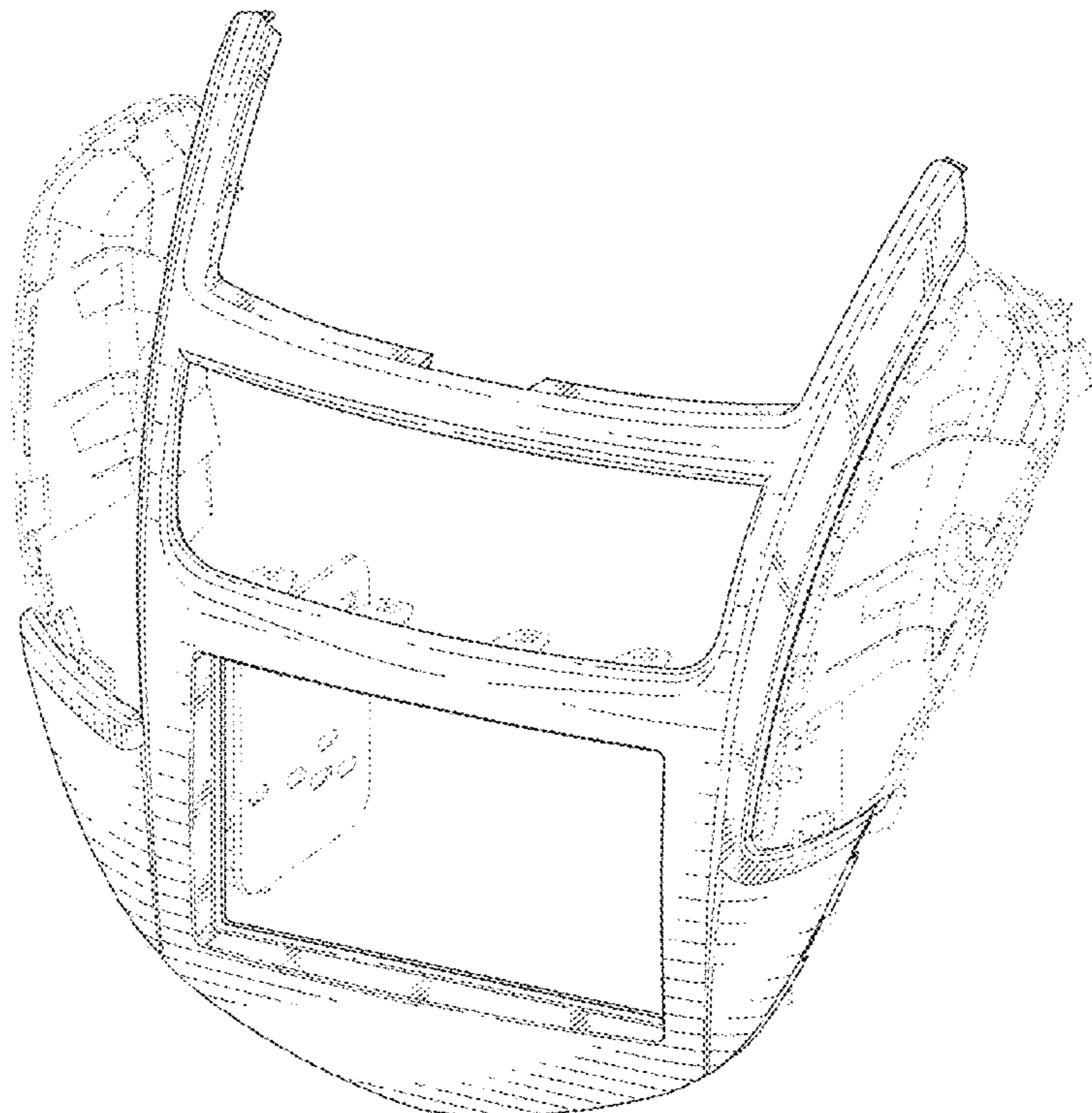

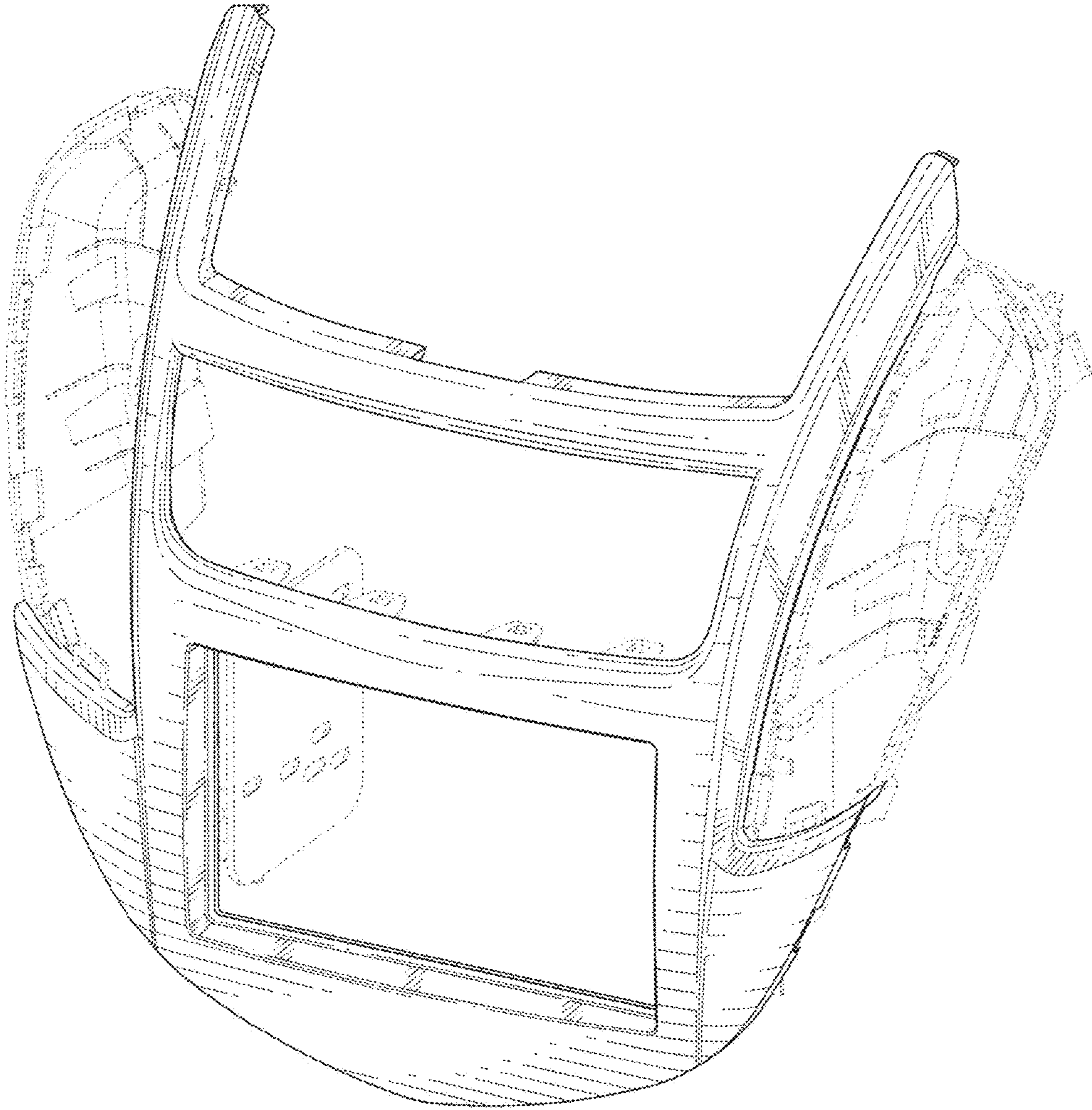

FIG. 1

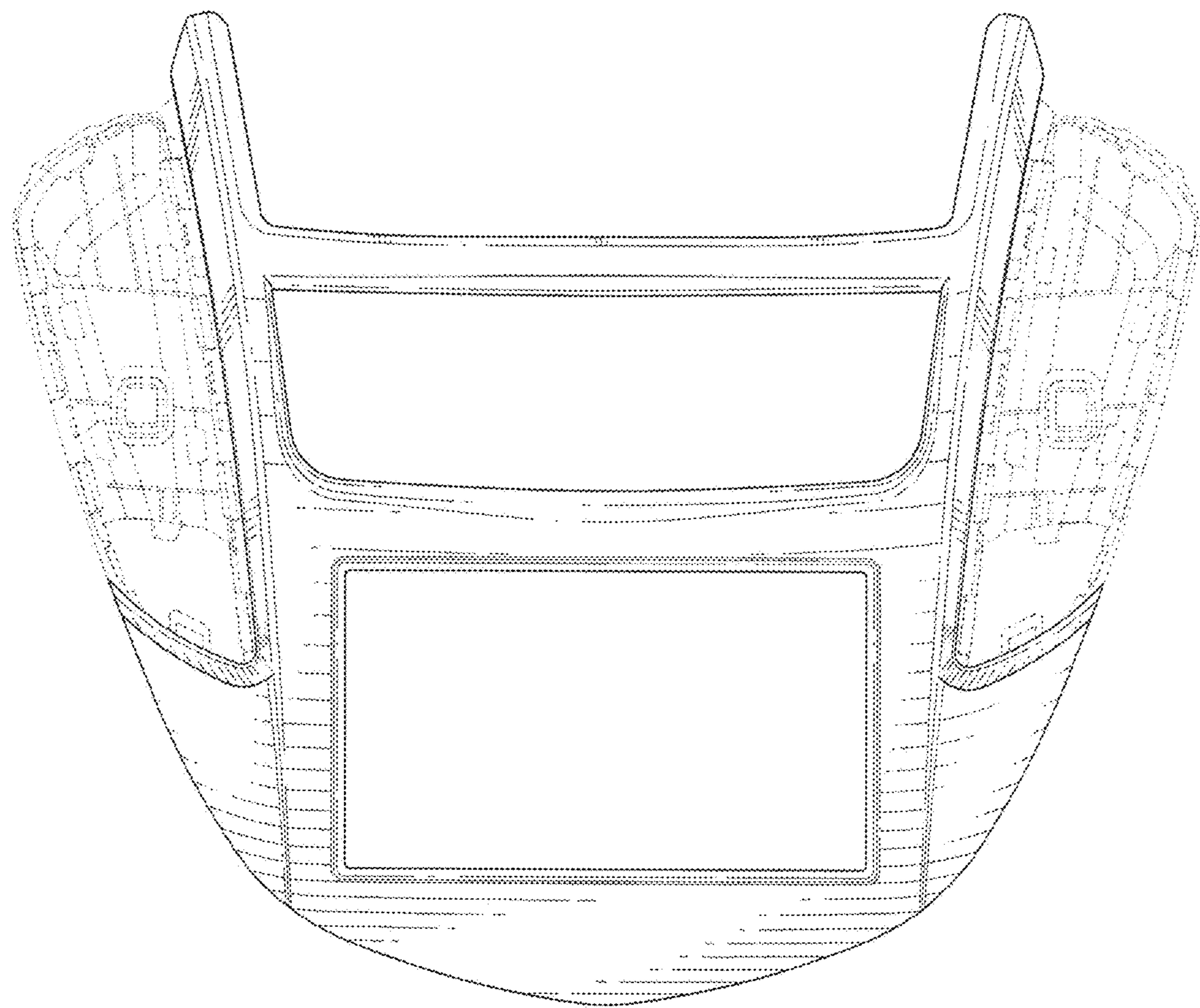

FIG. 2

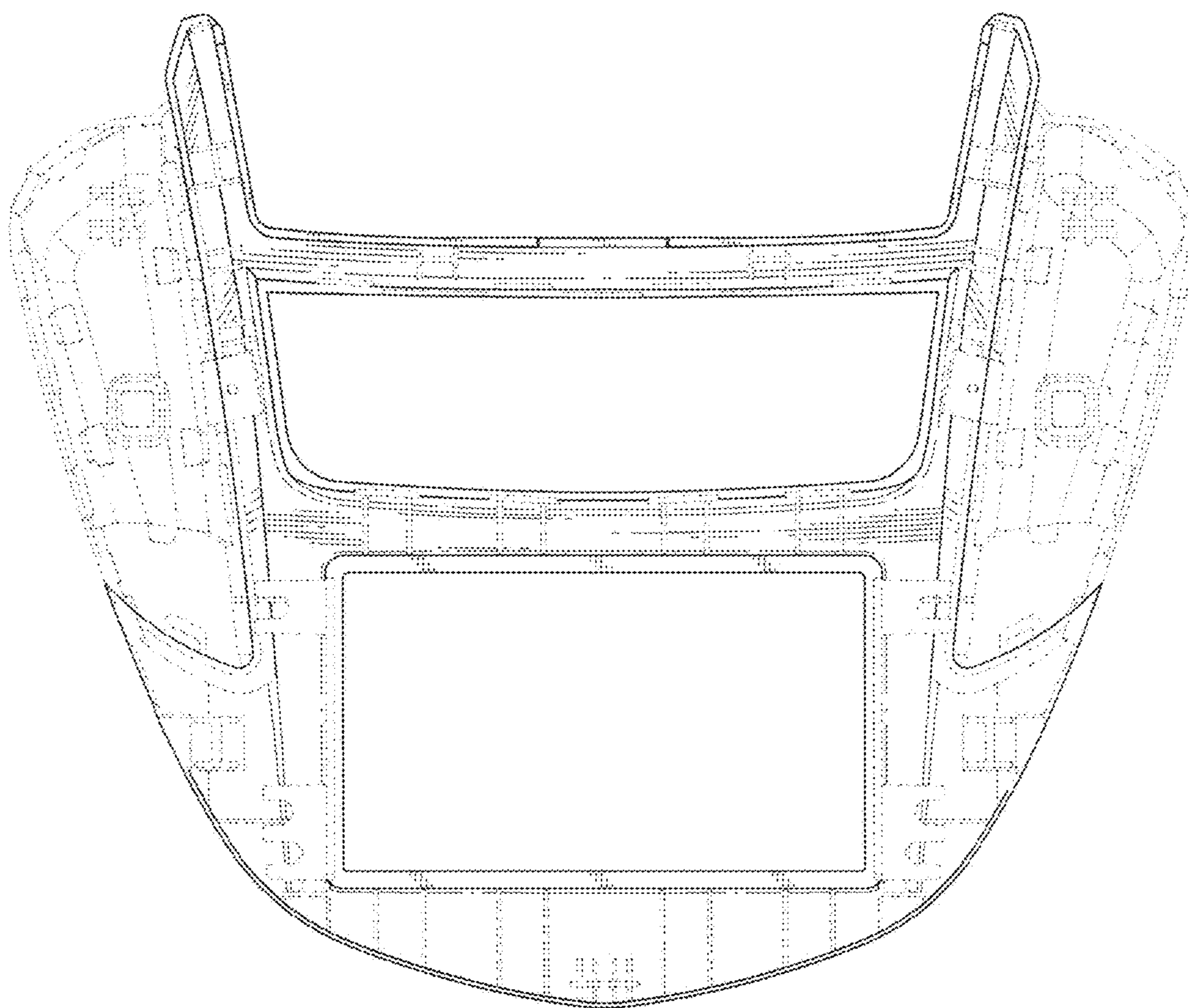

FIG. 3

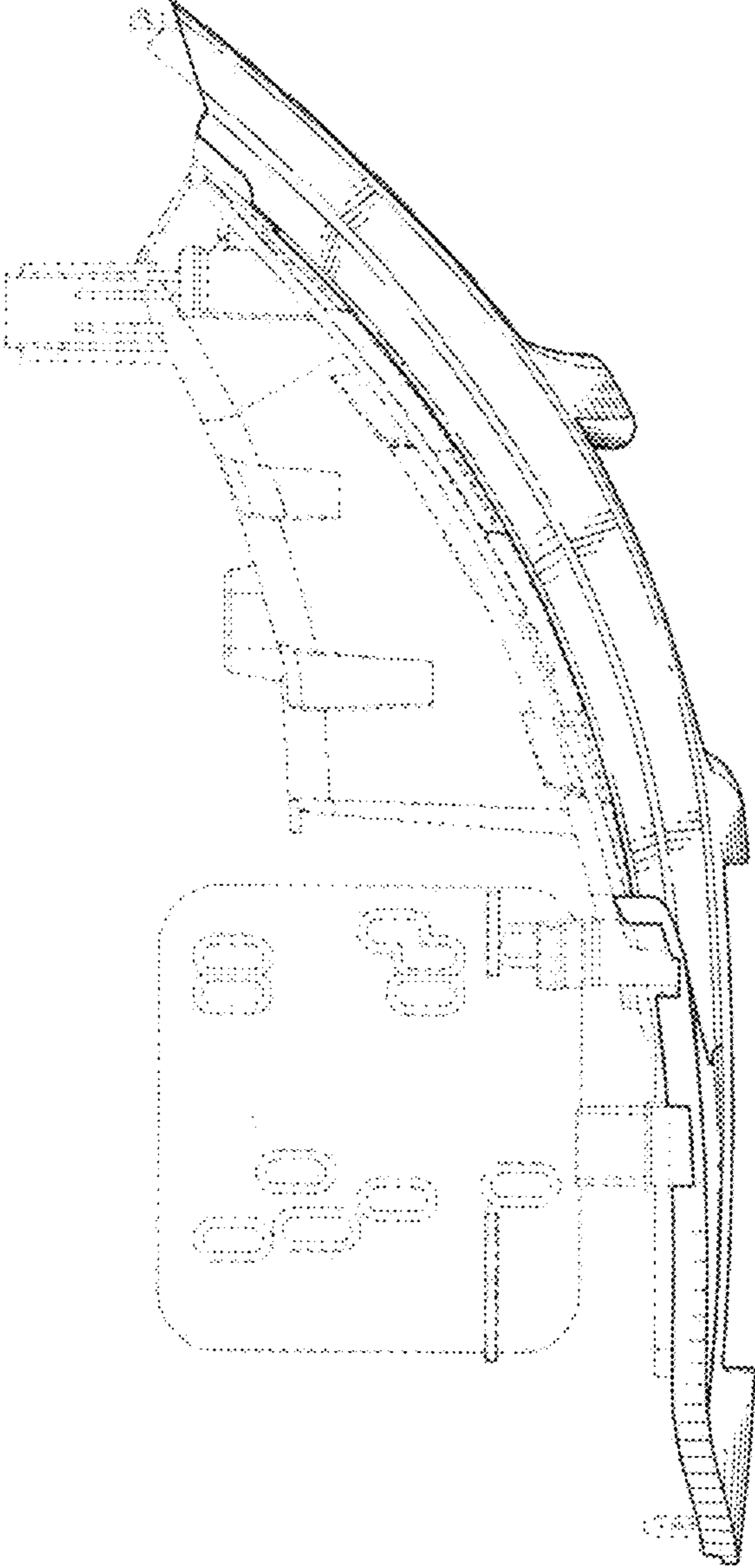

FIG. 4

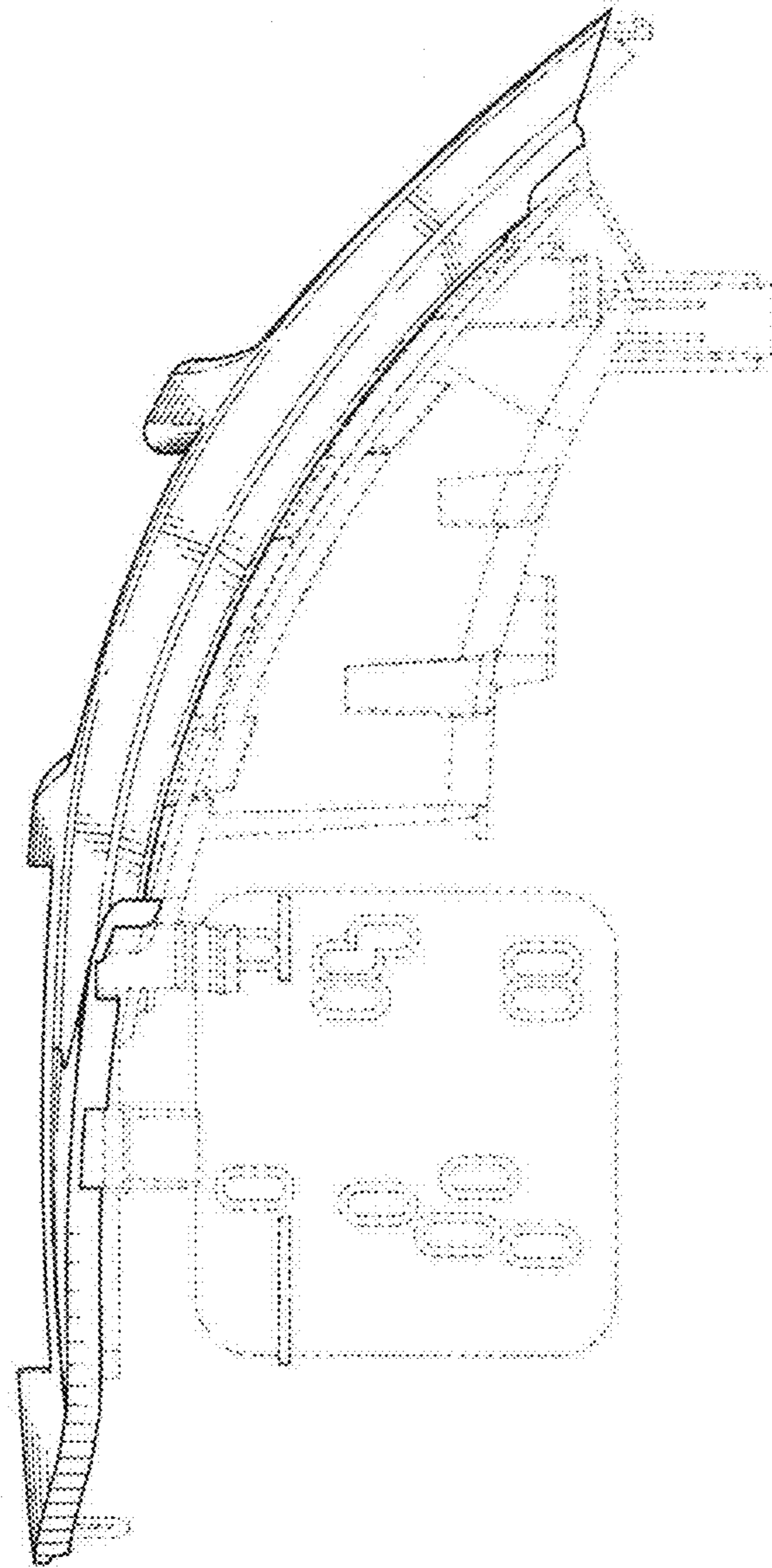

FIG. 5

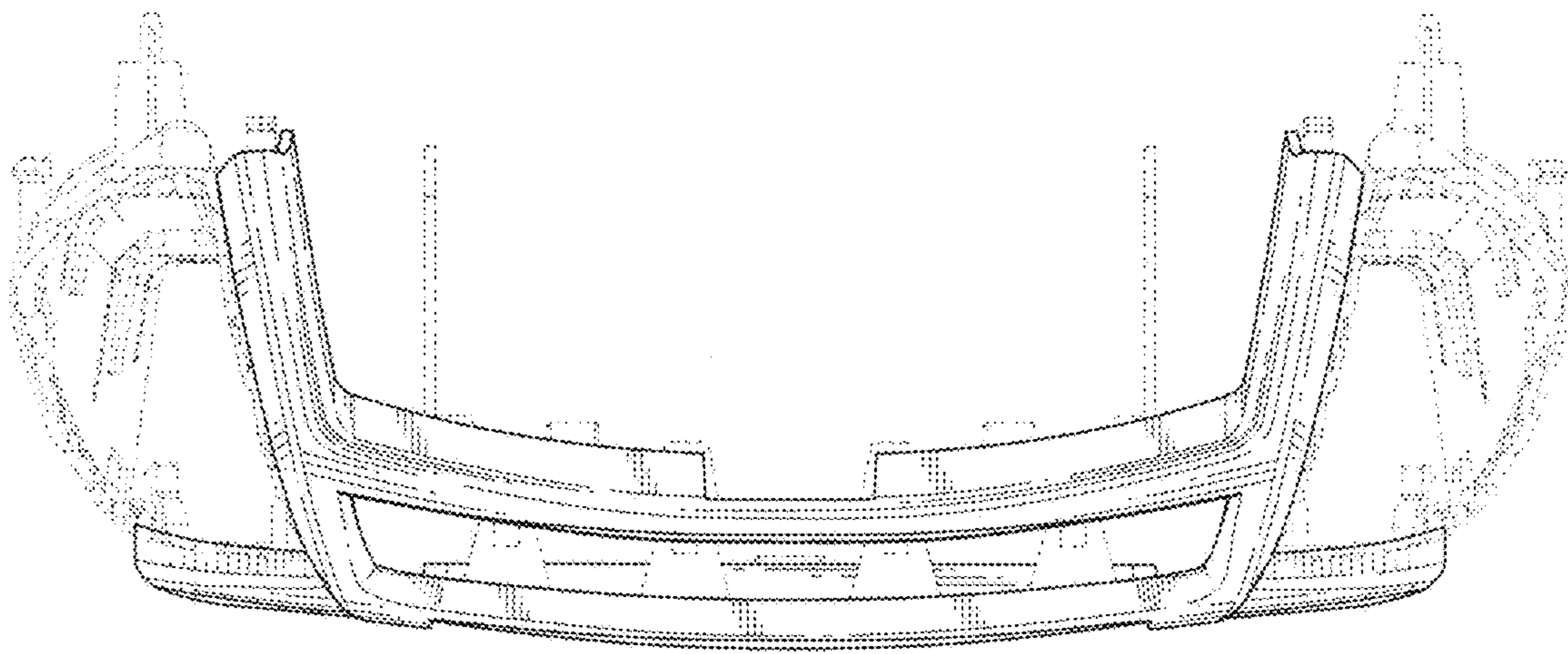

FIG. 6

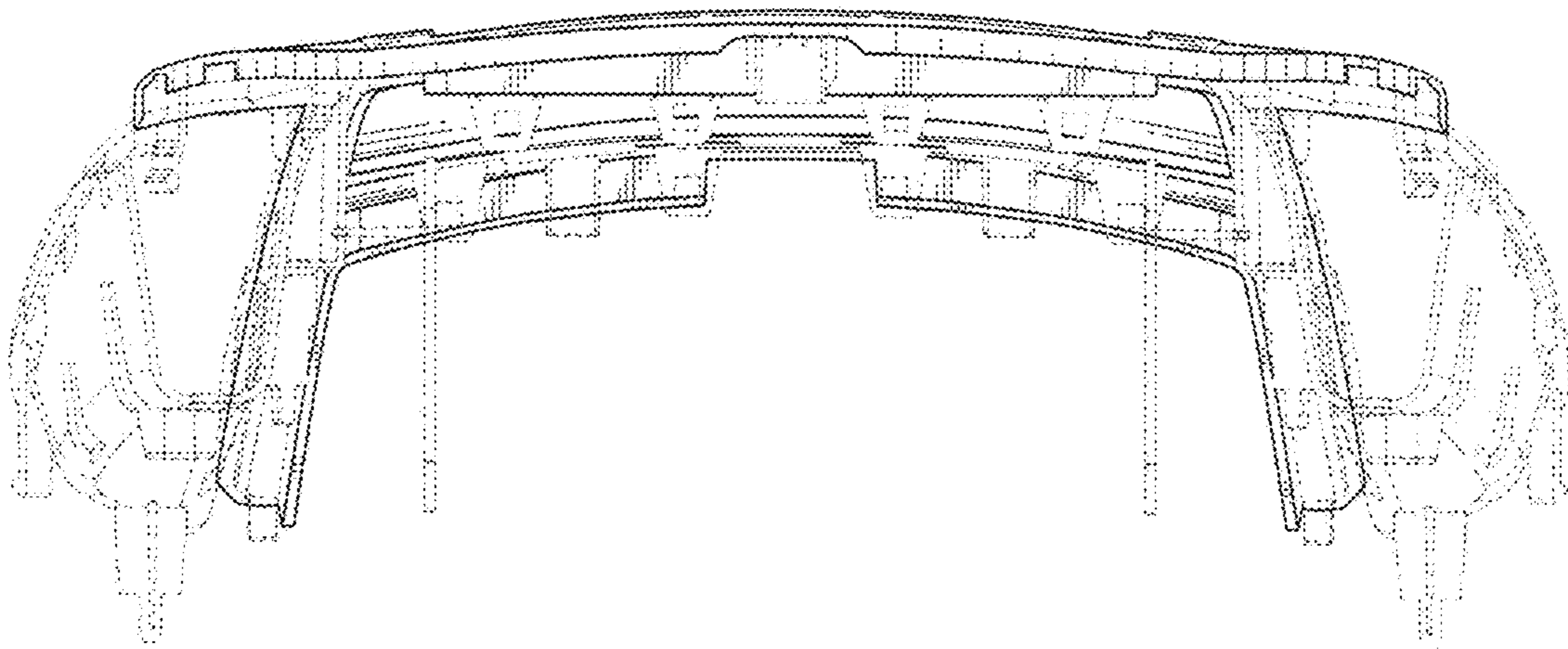

FIG. 7