



US00D807839S

(12) **United States Design Patent**  
**Vijayan**

(10) **Patent No.:** **US D807,839 S**

(45) **Date of Patent:** **\*\* Jan. 16, 2018**

(54) **PORTABLE SET TOP BOX**

(71) Applicant: **Lukup Technologies Pvt Ltd,**  
Bangalore (IN)

(72) Inventor: **Sujith Vijayan,** Bangalore (IN)

(73) Assignee: **Lukup Technologies Pvt Ltd,**  
Bangalore (IN)

(\*\*) Term: **15 Years**

(21) Appl. No.: **29/569,158**

(22) Filed: **Jun. 24, 2016**

(51) **LOC (11) Cl.** ..... **14-03**

(52) **U.S. Cl.**  
USPC ..... **D14/125**

(58) **Field of Classification Search**  
USPC ..... D14/125, 357-358, 496, 188, 242, 432;  
D13/184; 348/10, 460, 706, 731;  
340/825.03; 455/6.1, 6.2; 312/223.1, 7.2  
CPC ..... H04N 7/00  
See application file for complete search history.

(56) **References Cited**

**U.S. PATENT DOCUMENTS**

D358,408 S \* 5/1995 McGarry ..... D14/374  
7,573,385 B2 \* 8/2009 Tonelli ..... A45C 13/42  
340/539.32

D661,670 S \* 6/2012 Huang ..... D14/125  
D664,499 S \* 7/2012 Workman ..... D13/107  
D692,177 S \* 10/2013 Angiolillo ..... D27/189  
D719,095 S \* 12/2014 Oota ..... D13/103  
D722,587 S \* 2/2015 Green ..... D14/188

\* cited by examiner

*Primary Examiner* — Randall Gholson

(74) *Attorney, Agent, or Firm* — Danielson Legal LLC

(57) **CLAIM**

The ornamental design for a portable set top box, substantially as shown.

**DESCRIPTION**

FIG. 1 is the front view of one embodiment of the portable set top box incorporating my design; FIG. 2 is a left side view thereof; FIG. 3 is an isometric view thereof; FIG. 4 is a back view thereof; FIG. 5 is a bottom view thereof; FIG. 6 is a top view thereof; and, FIG. 7 is a right side view thereof.

A design for a portable set top box is shown in FIGS. 1-7. Any broken lines shown form no part of the claimed design.

**1 Claim, 7 Drawing Sheets**

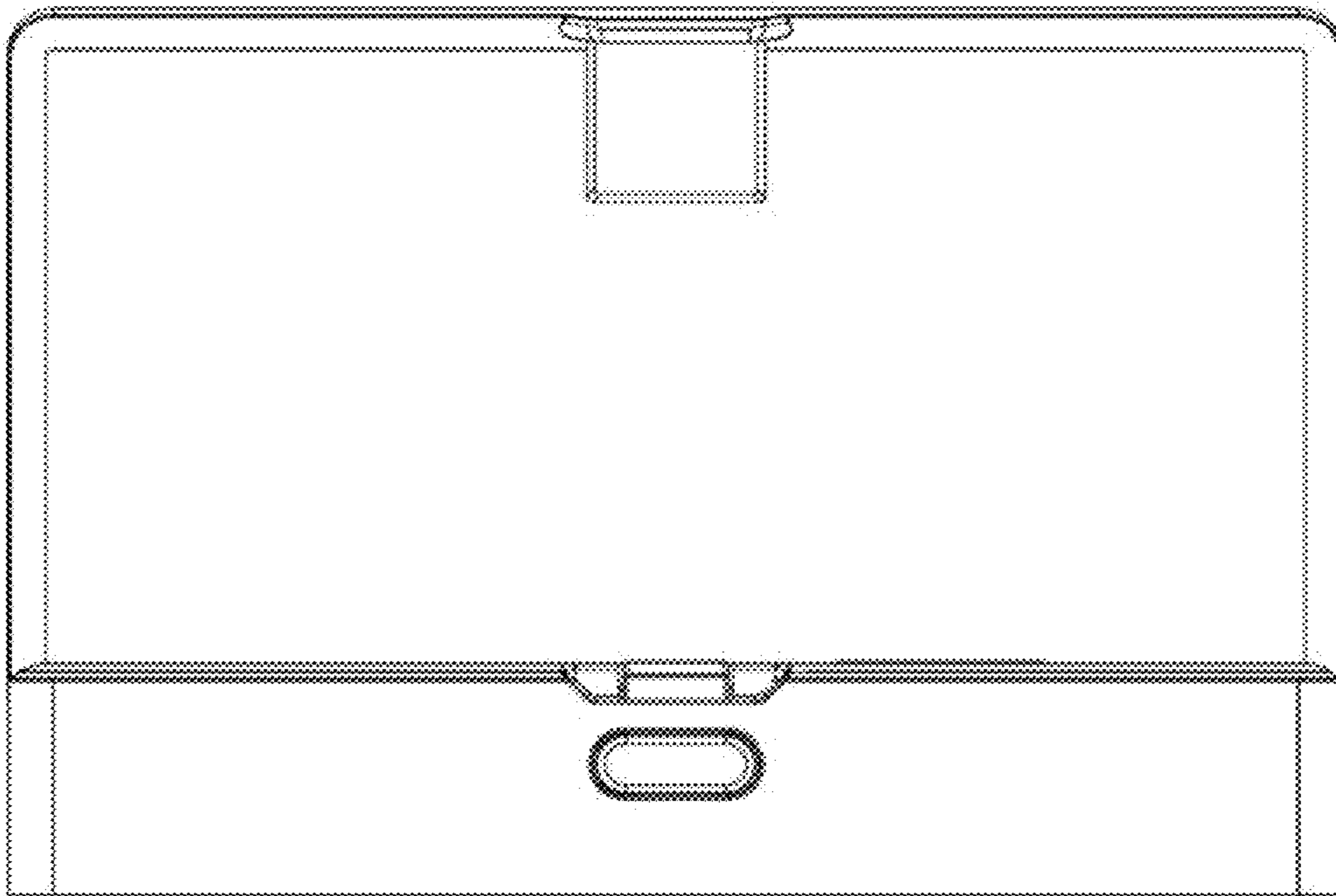

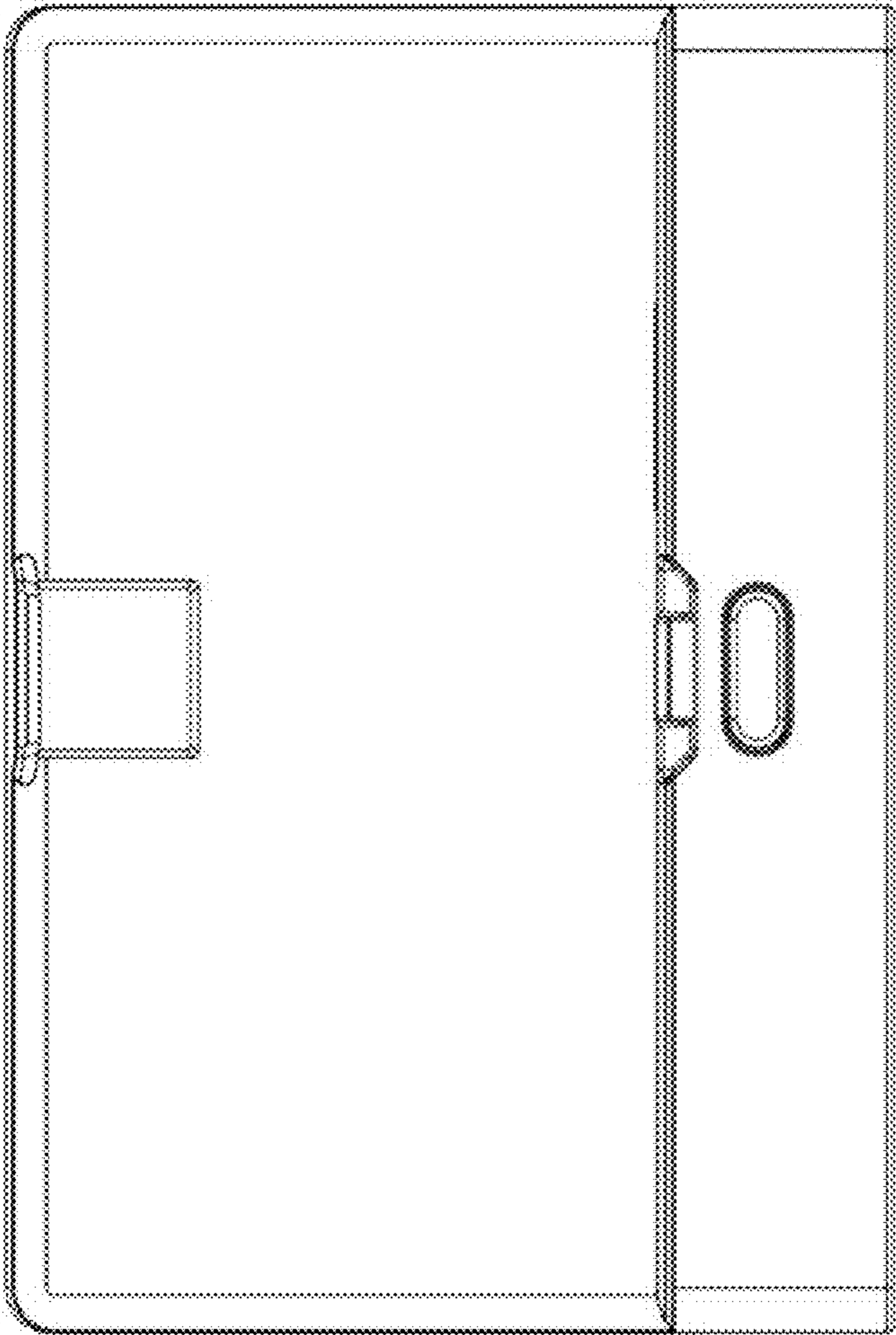
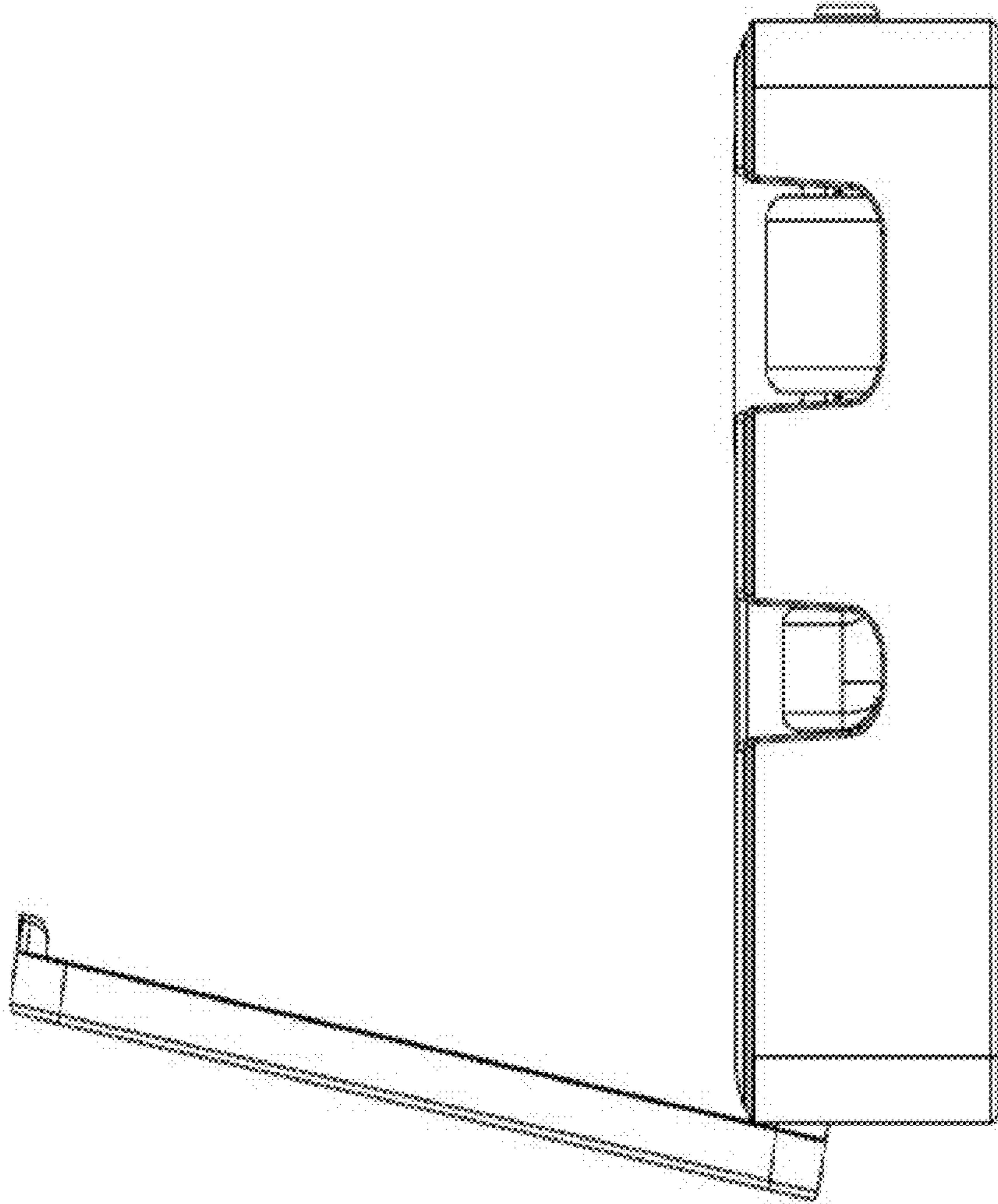

FIG. 1



**FIG. 2**

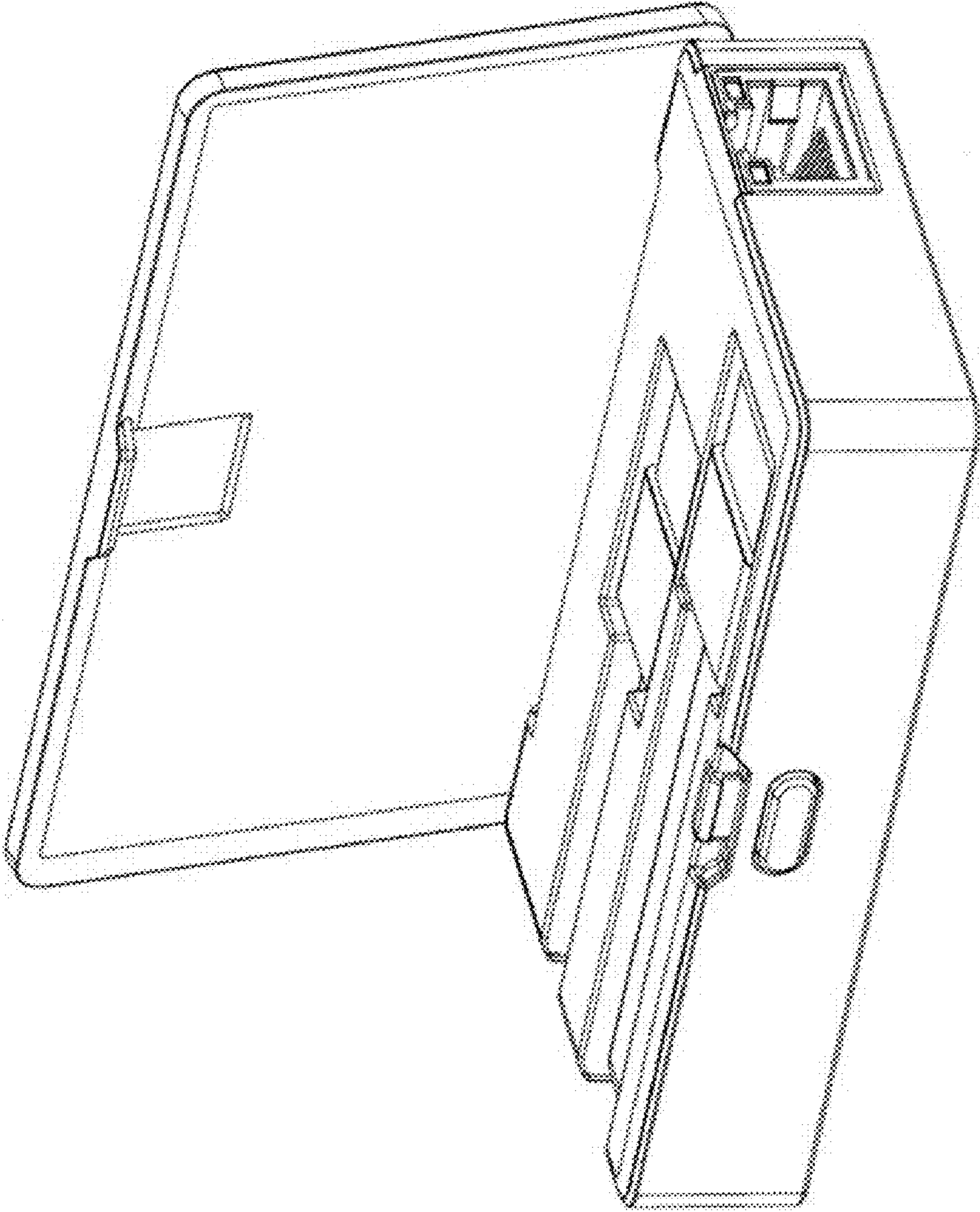
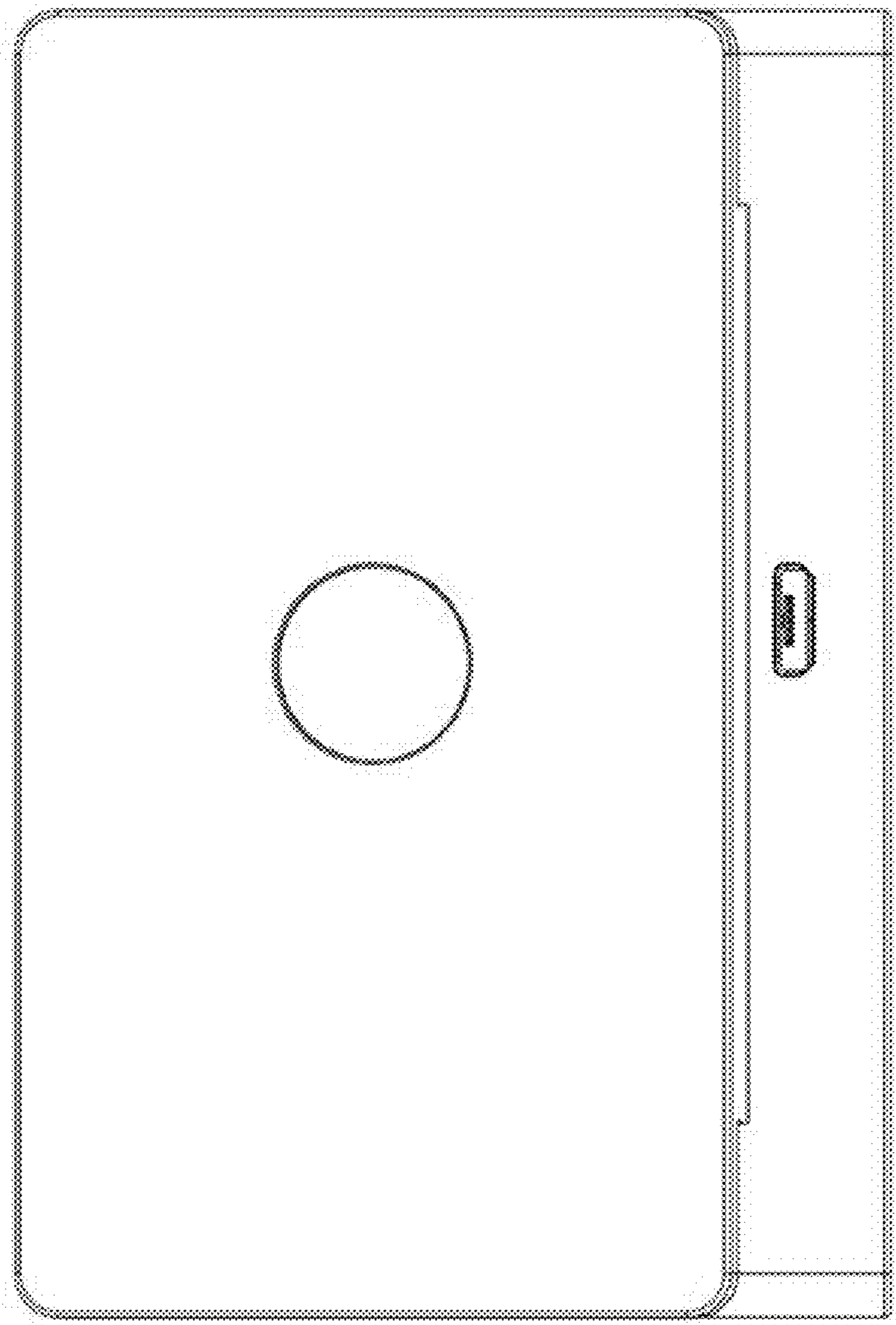
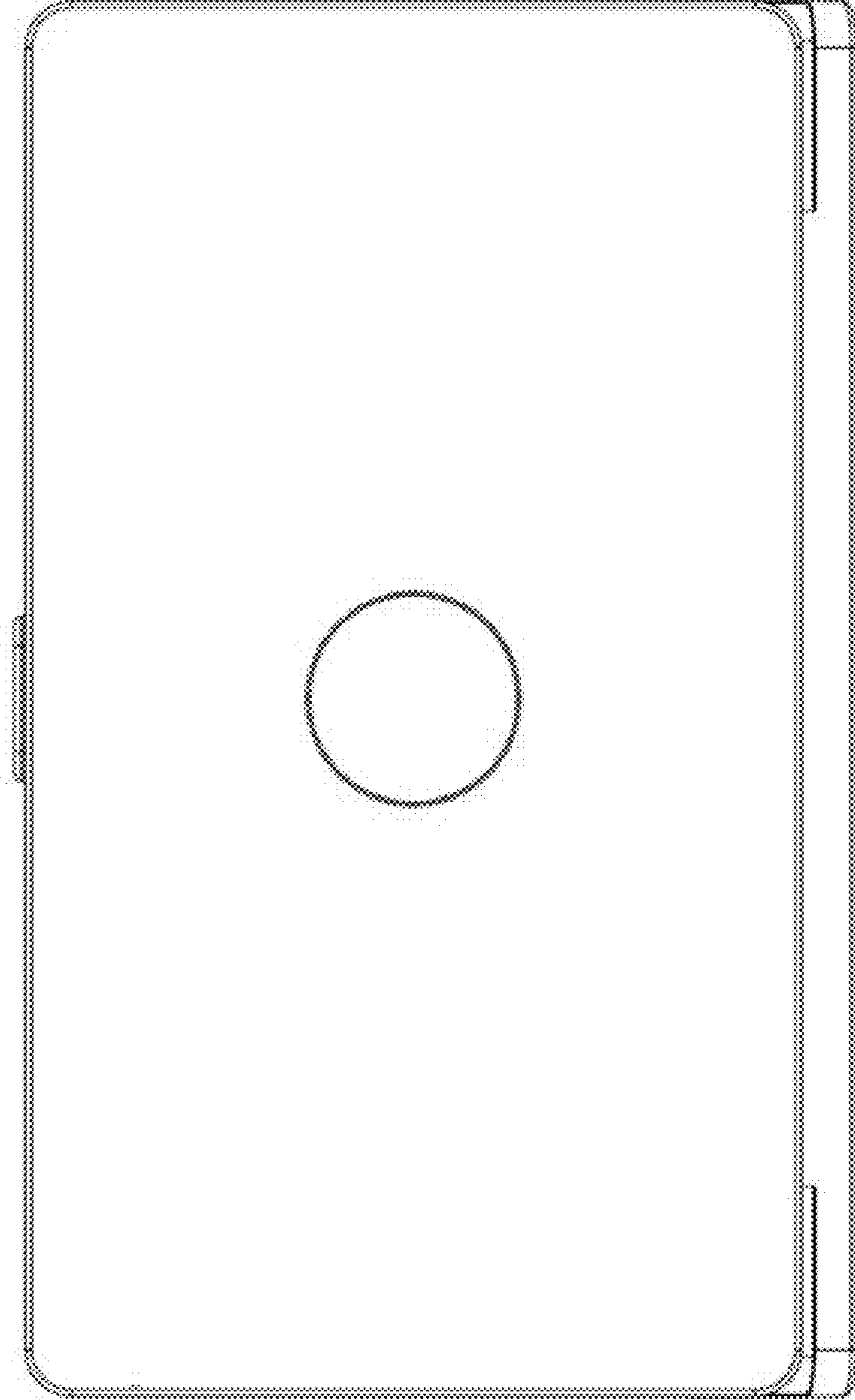

FIG. 3



**FIG. 4**



**FIG. 5**

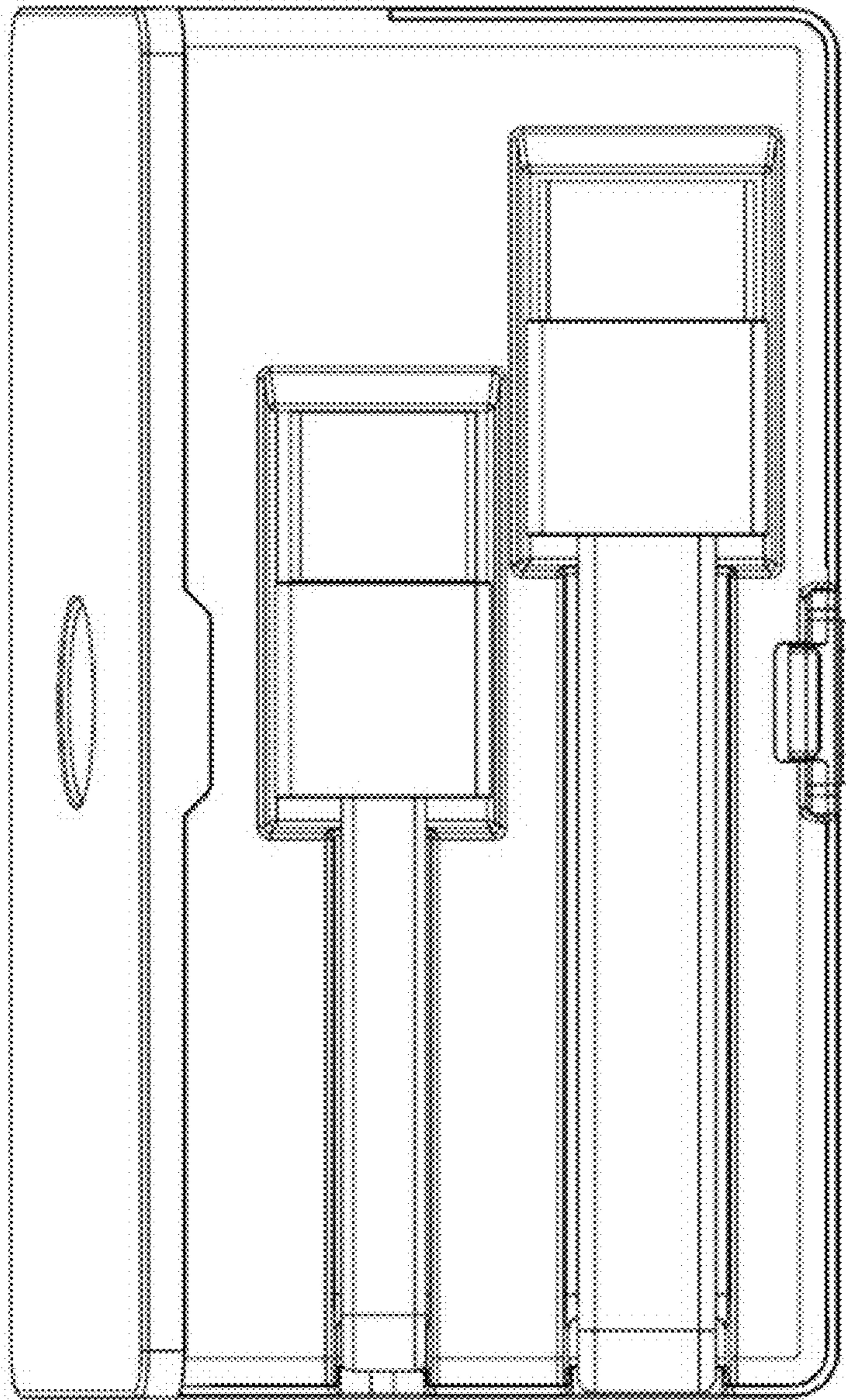

**FIG. 6**

FIG. 7

