



US00D807798S

(12) **United States Design Patent**
Piscitelli et al.

(10) **Patent No.:** **US D807,798 S**
(45) **Date of Patent:** **** Jan. 16, 2018**

(54) **VEHICLE GRILLE**

(71) Applicants: **Chris Piscitelli**, West Bloomfield, MI (US); **Vincent J. Galante**, Lake Orion, MI (US); **Brian H. Nielander**, Royal Oak, MI (US)

(72) Inventors: **Chris Piscitelli**, West Bloomfield, MI (US); **Vincent J. Galante**, Lake Orion, MI (US); **Brian H. Nielander**, Royal Oak, MI (US)

(73) Assignee: **FCA US LLC**, Auburn Hills, MI (US)

(**) Term: **15 Years**

(21) Appl. No.: **29/594,737**

(22) Filed: **Feb. 22, 2017**

Related U.S. Application Data

(63) Continuation-in-part of application No. 29/568,731, filed on Jun. 21, 2016.

(51) **LOC (11) Cl.** **12-16**

(52) **U.S. Cl.**
USPC **D12/163**

(58) **Field of Classification Search**
USPC D12/163, 196, 86, 90-92, 171, 169, 216, D12/98; 180/68.1, 68.6; 293/193.11
CPC B62D 25/08; B62B 9/16; B60K 11/08; B60R 19/52

See application file for complete search history.

(56) **References Cited**

U.S. PATENT DOCUMENTS

D424,992 S	5/2000	Faurote	
D506,955 S	7/2005	Allen et al.	
D519,066 S	4/2006	Ney et al.	
D542,192 S	5/2007	Renkert et al.	
D572,179 S	7/2008	Zimmermann et al.	
D661,231 S	6/2012	Galante et al.	
D720,265 S *	12/2014	Galante	D12/169
D733,619 S	7/2015	Glover et al.	
D743,850 S	11/2015	Howell et al.	
D746,731 S *	1/2016	Quezada	D12/163

* cited by examiner

Primary Examiner — Melody N. Brown

(74) *Attorney, Agent, or Firm* — Ralph E. Smith

(57) **CLAIM**

The ornamental design for a vehicle grille, as shown and described.

DESCRIPTION

FIG. 1 is a from perspective view of a vehicle grille showing our new design;

FIG. 2 is a front view thereof;

FIG. 3 is a rear view thereof;

FIG. 4 is a side view thereof;

FIG. 5 is a top view thereof; and,

FIG. 6 is a bottom view.

It will be understood that the broken lines shown in the drawings illustrate portions of the vehicle grille that form no part of claimed design.

1 Claim, 6 Drawing Sheets

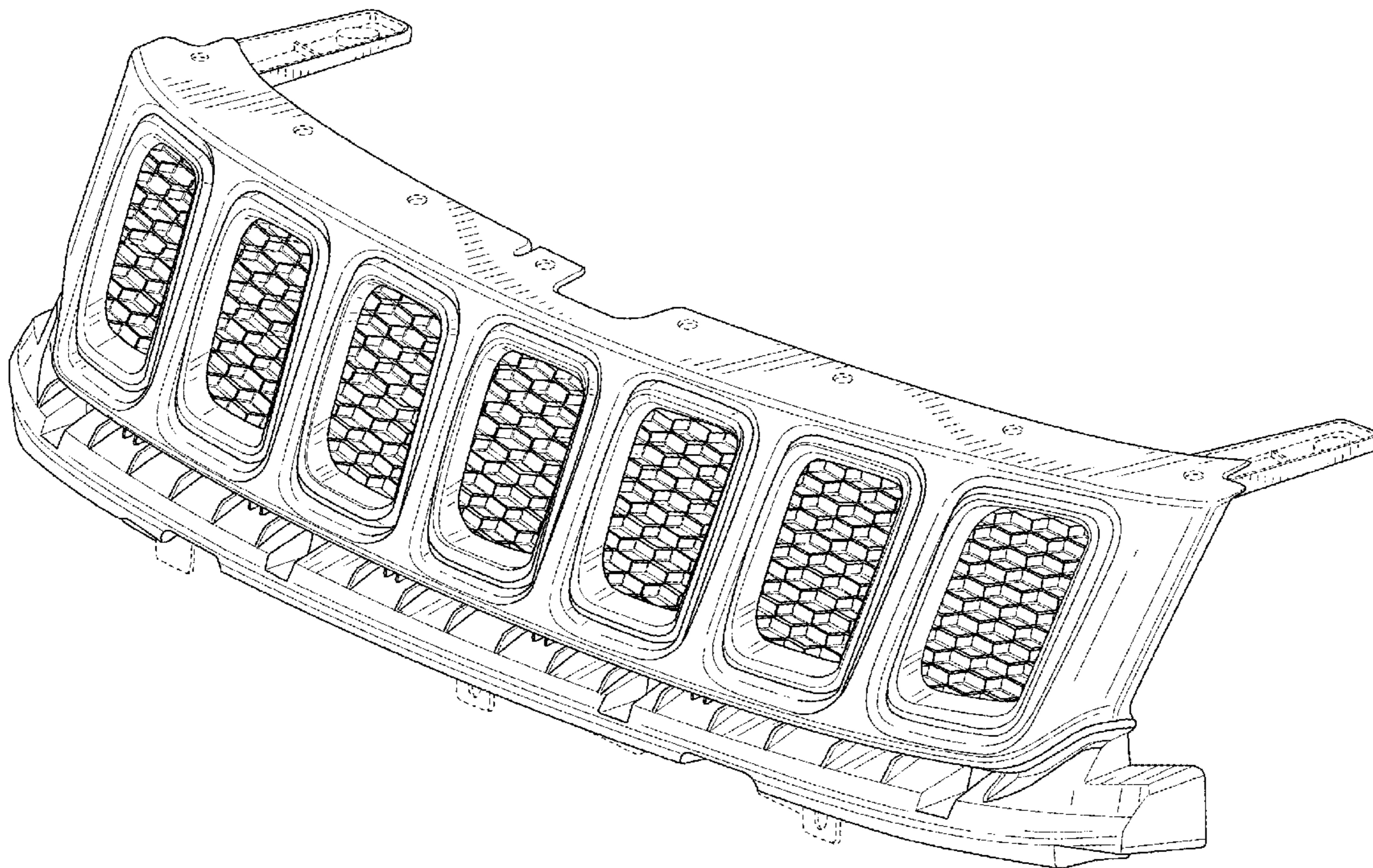

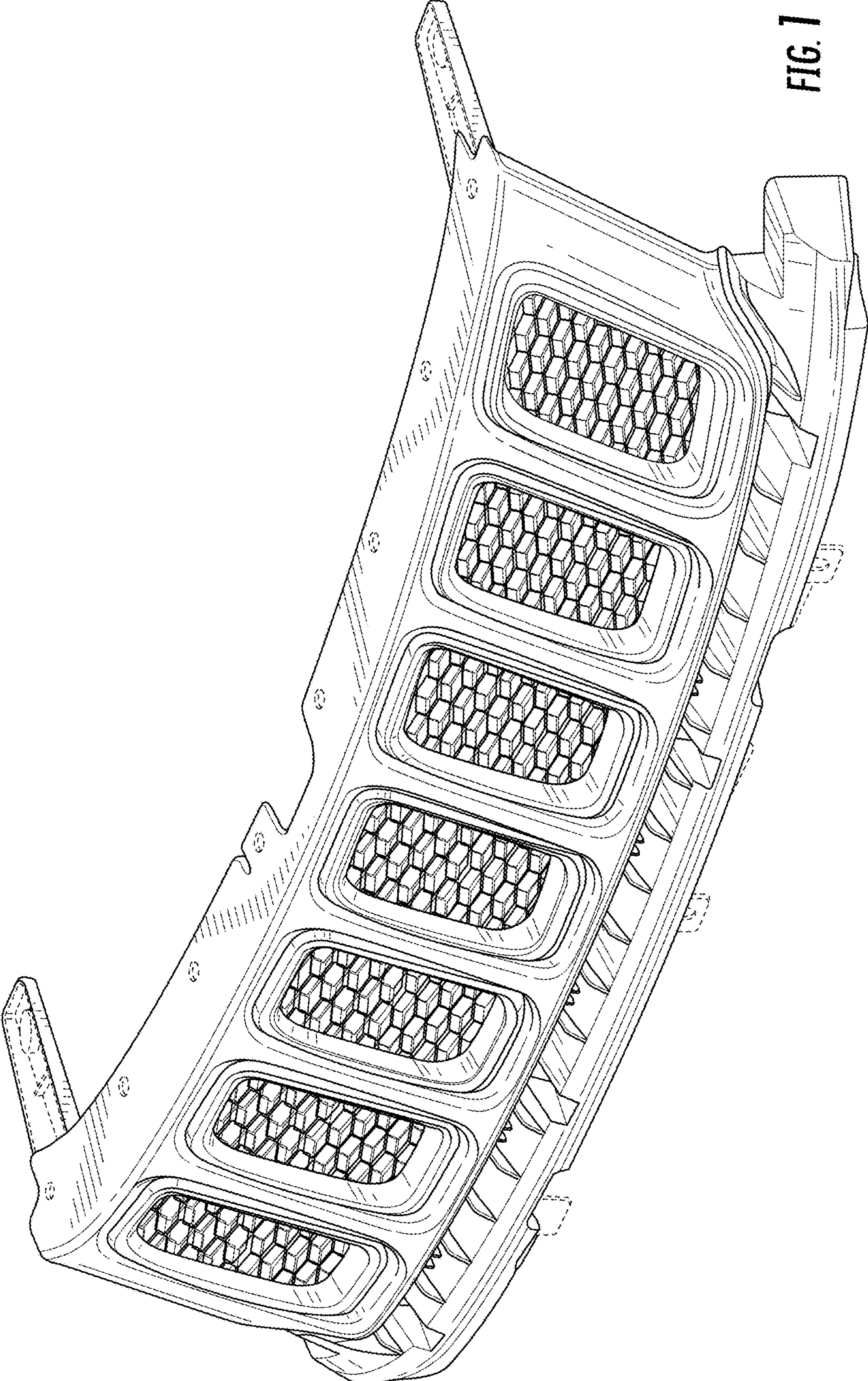

FIG. 1

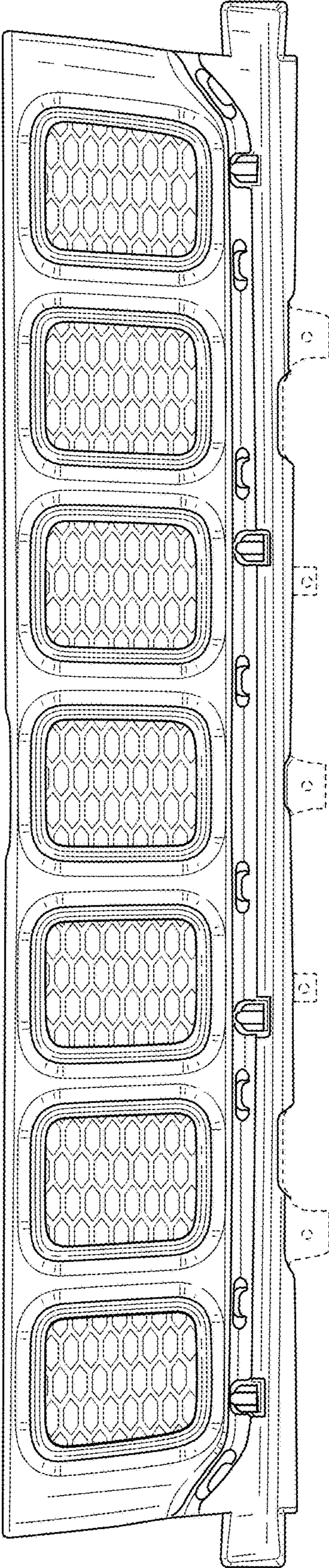

FIG. 2

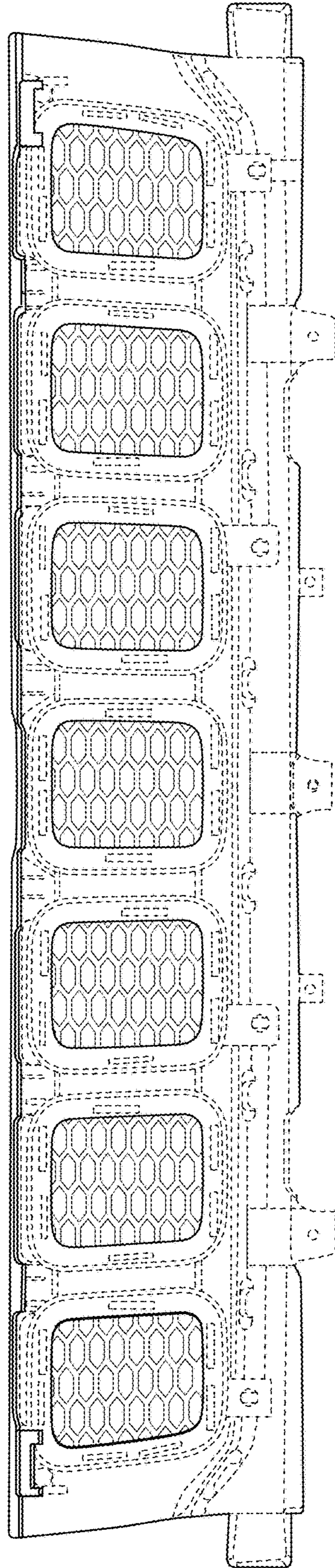

FIG. 3

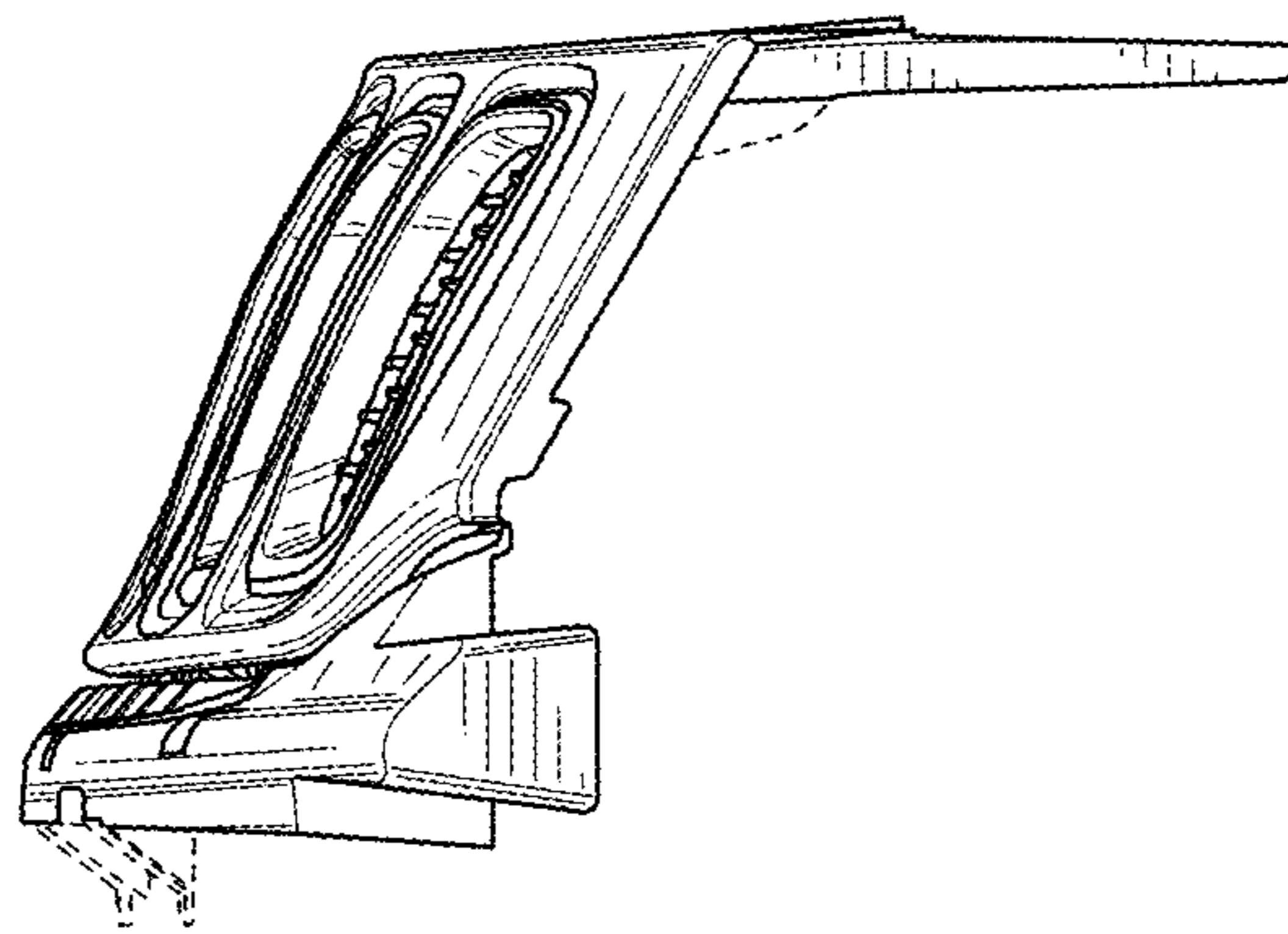

FIG. 4

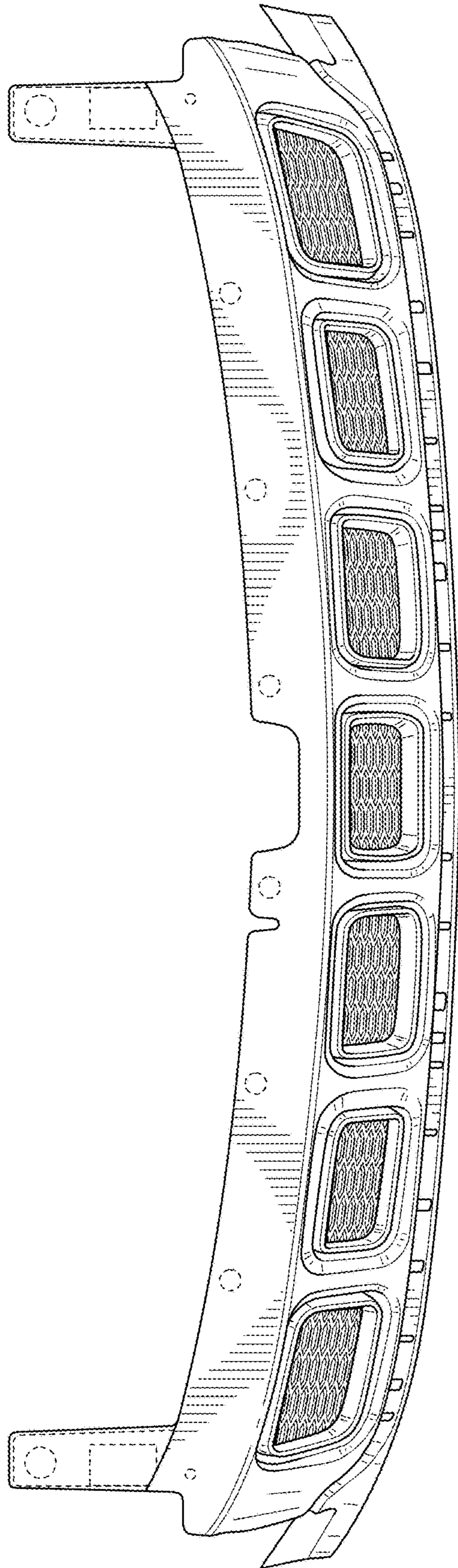

FIG. 5

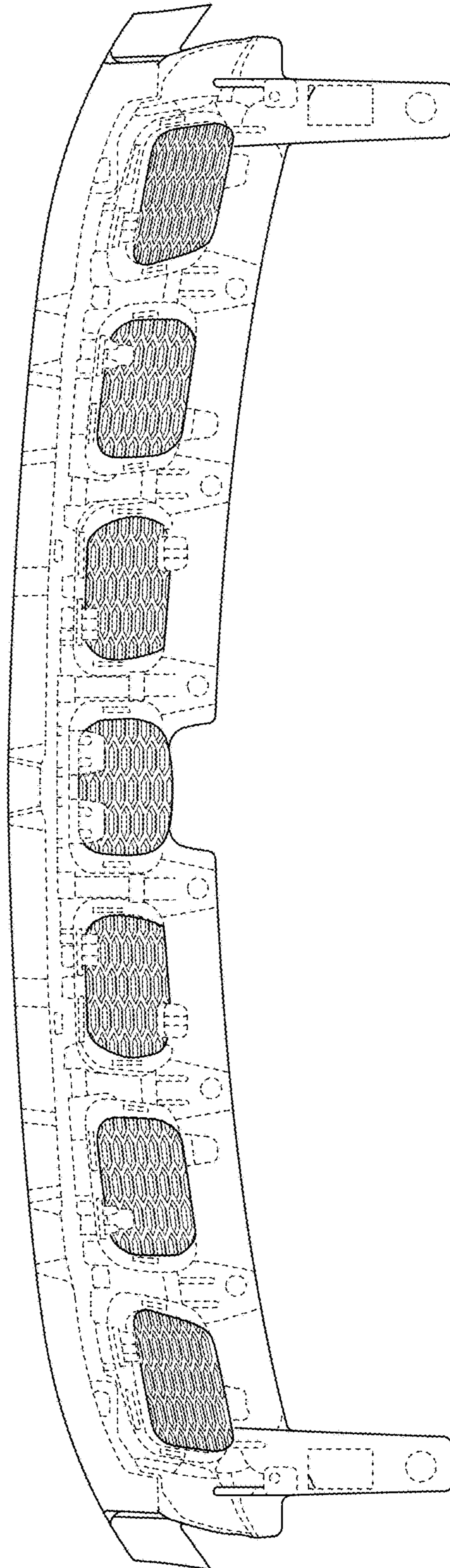

FIG. 6