



US00D807728S

(12) **United States Design Patent**
Johnson et al.

(10) **Patent No.:** **US D807,728 S**
(45) **Date of Patent:** **** Jan. 16, 2018**

(54) **IMPLEMENT ATTACHMENT BRACKET**

D736,010 S * 8/2015 Reed, Jr. D6/553
D759,473 S * 6/2016 Zhou D8/388

(71) Applicant: **Behlen Mfg. Co.**, Columbus, NE (US)

* cited by examiner

(72) Inventors: **Rob Johnson**, Columbus, NE (US);
Nicholas Blaser, Columbus, NE (US);
Wilfrido Avila, Columbus, NE (US)

Primary Examiner — Lakiya Rogers

Assistant Examiner — Harold E Blackwell, II

(73) Assignee: **Behlen Mfg. Co.**, Columbus, NE (US)

(74) *Attorney, Agent, or Firm* — Ryan T. Grace; Advent, LLP

(**) Term: **14 Years**

(57) **CLAIM**

The ornamental design for an implement attachment bracket, as shown and described.

(21) Appl. No.: **29/520,885**

DESCRIPTION

(22) Filed: **Mar. 18, 2015**

(51) **LOC (11) Cl.** **08-05**

(52) **U.S. Cl.**
USPC **D8/354**

(58) **Field of Classification Search**
USPC D8/71, 72, 349, 354, 356, 382, 394, 499,
D8/353, 388
CPC E02D 5/801; E02D 5/74
See application file for complete search history.

FIG. 1 is a first end elevation view of an implement attachment bracket.

FIG. 2 is a second end elevation view of the implement attachment bracket of FIG. 1.

FIG. 3 is a first side elevation view of the implement attachment bracket of FIG. 1.

FIG. 4 is a second side elevation view of the implement attachment bracket of FIG. 1.

FIG. 5 is a top plan view of the implement attachment bracket of FIG. 1.

FIG. 6 is a bottom plan view of the implement attachment bracket of FIG. 1.

FIG. 7 is an isometric view of the implement attachment bracket of FIG. 1; and,

FIG. 8 is another isometric view of the implement attachment bracket of FIG. 1.

The broken lines in the FIGS. 1-8 illustrate portions of the implement attachment bracket which forms no part of the claimed design.

(56) **References Cited**

U.S. PATENT DOCUMENTS

D426,453 S * 6/2000 Stearns D8/354
D548,051 S * 8/2007 Ruppert D8/354
D599,193 S * 9/2009 Meyer D8/354
D614,477 S * 4/2010 Edwards E04F 11/1834
D8/354
8,221,049 B1 * 7/2012 Westendorf B66C 1/585
294/106
D698,628 S * 2/2014 Stanley D8/367

1 Claim, 8 Drawing Sheets

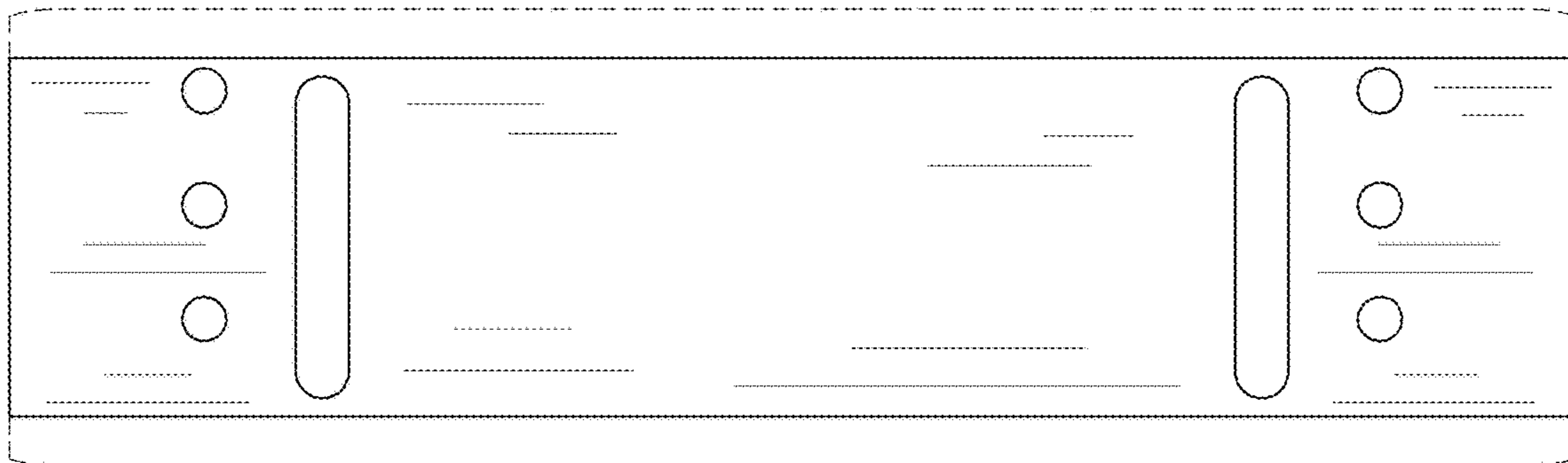



FIG. 1

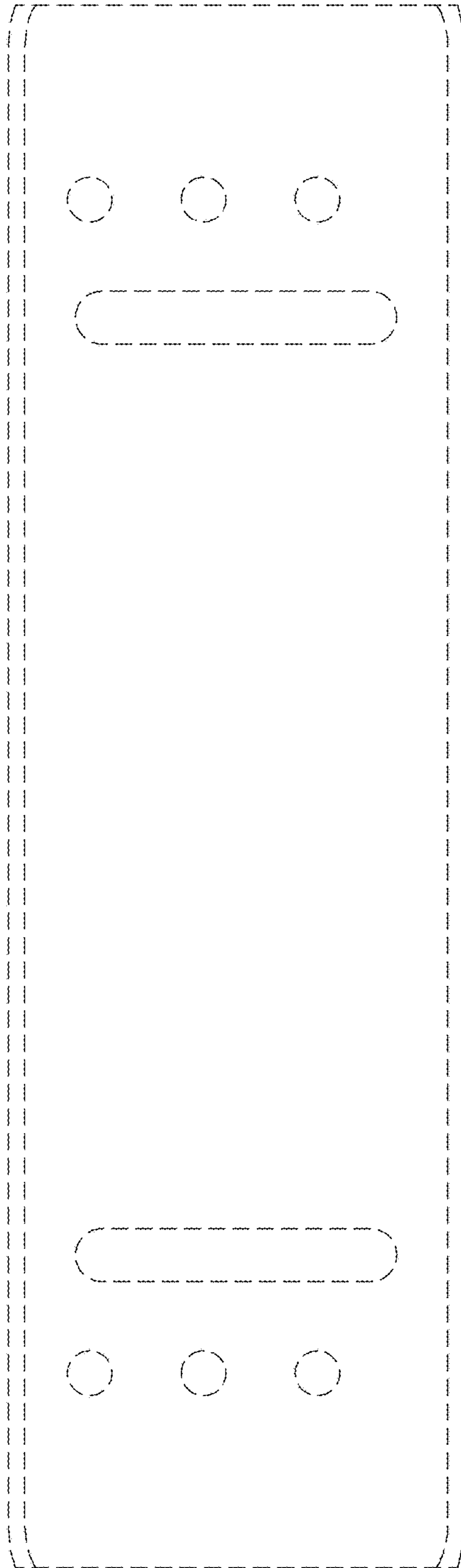

FIG. 2

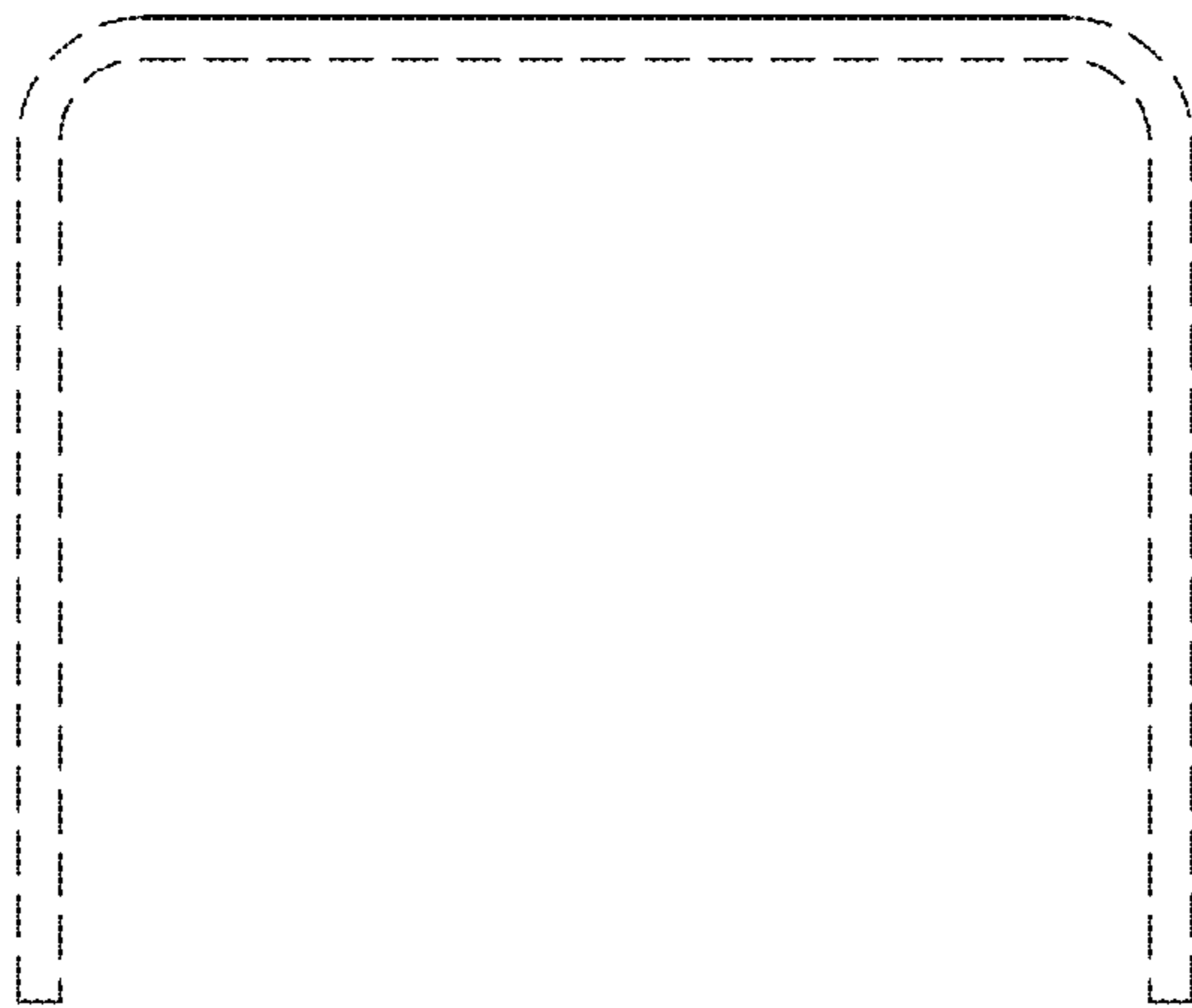

FIG. 3

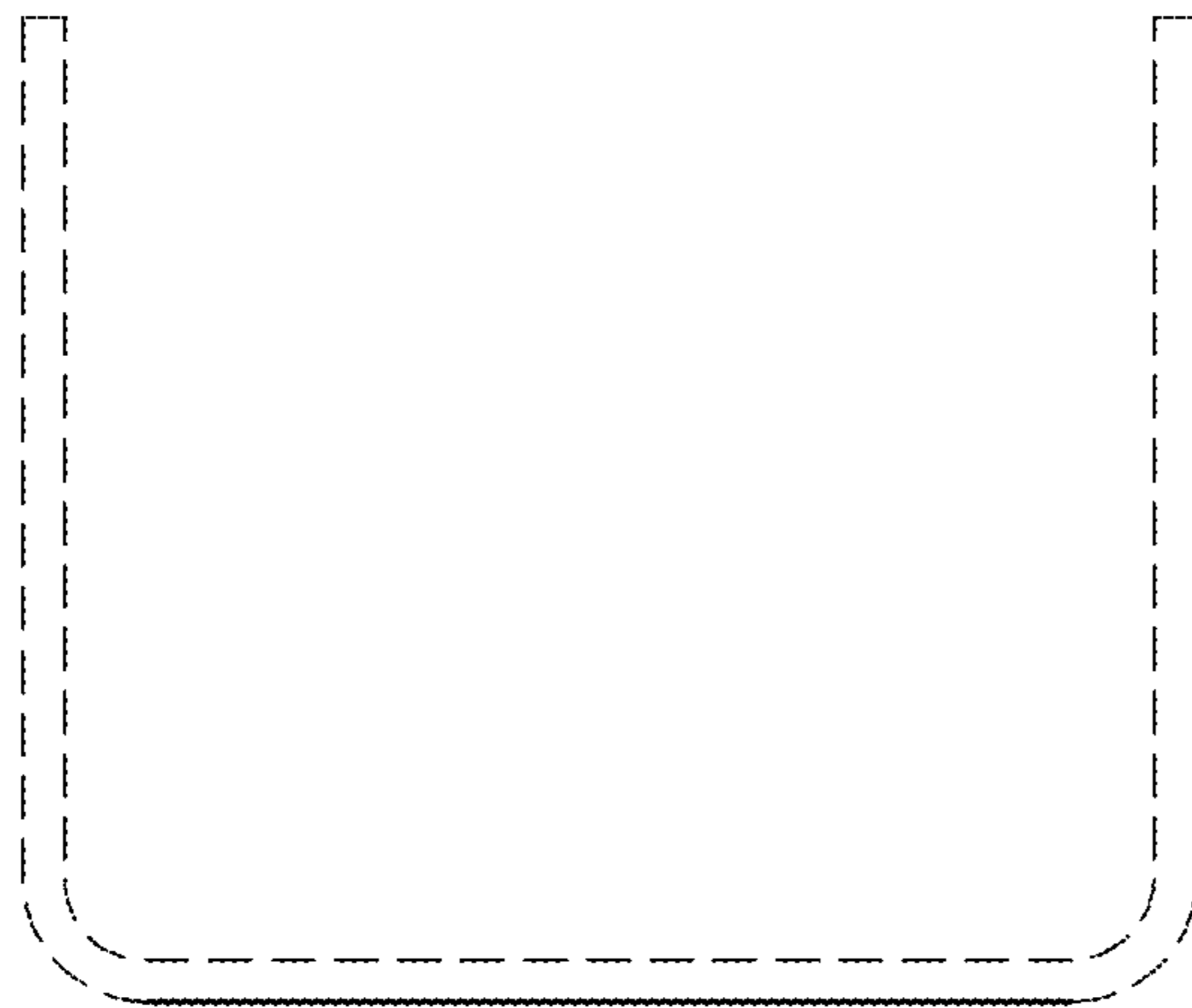

FIG. 4

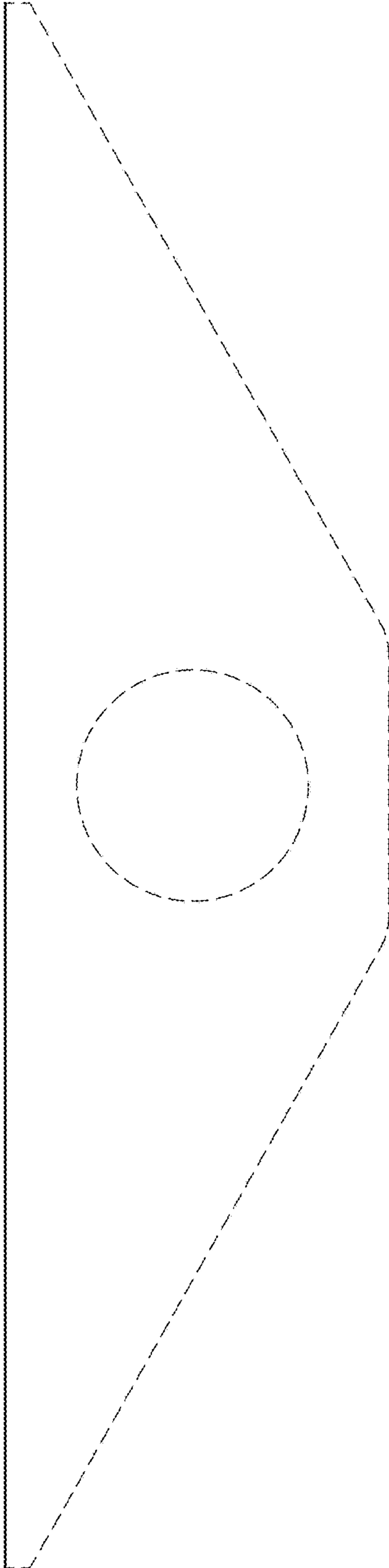

FIG. 5

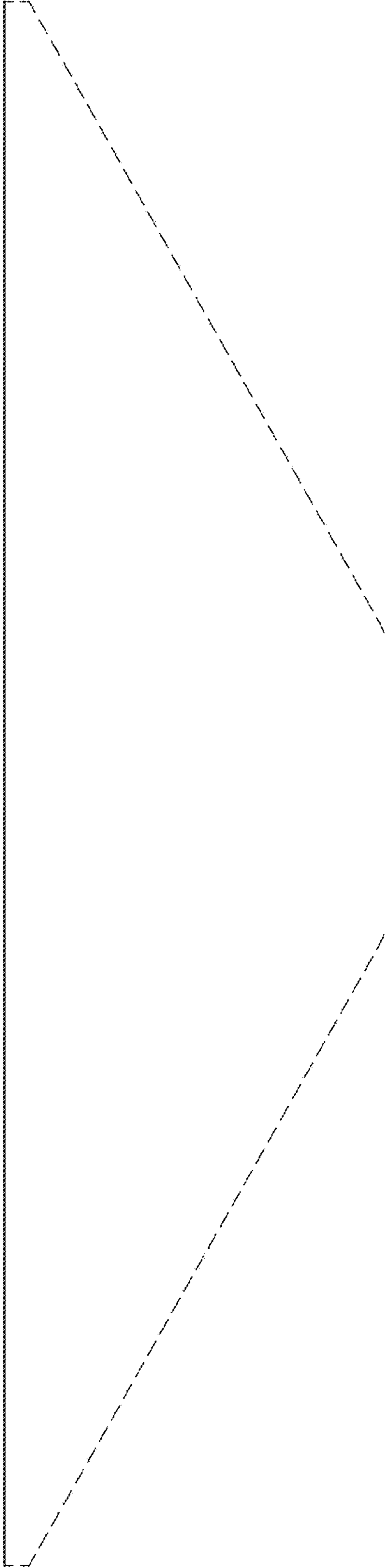

FIG. 6

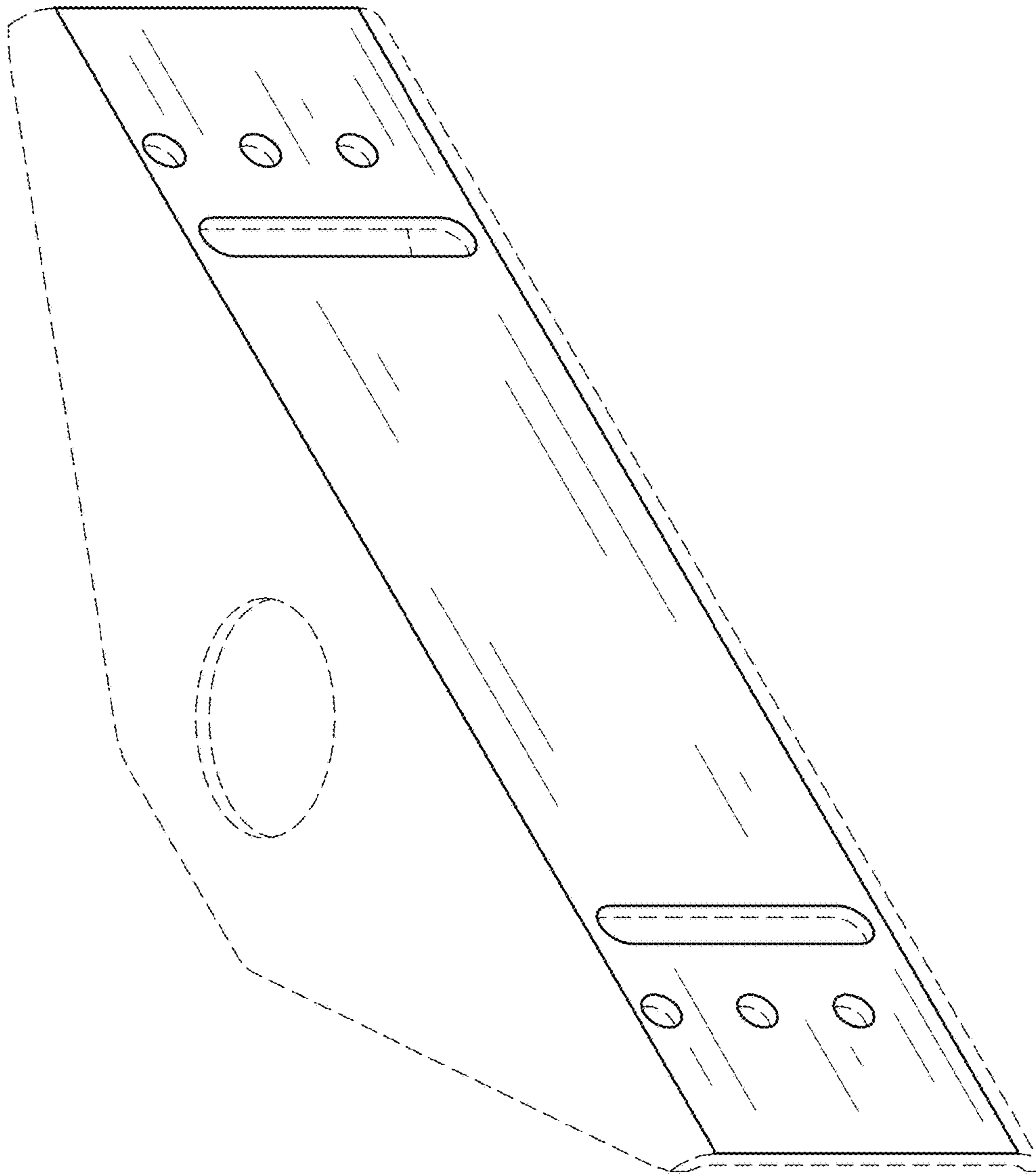

FIG. 7

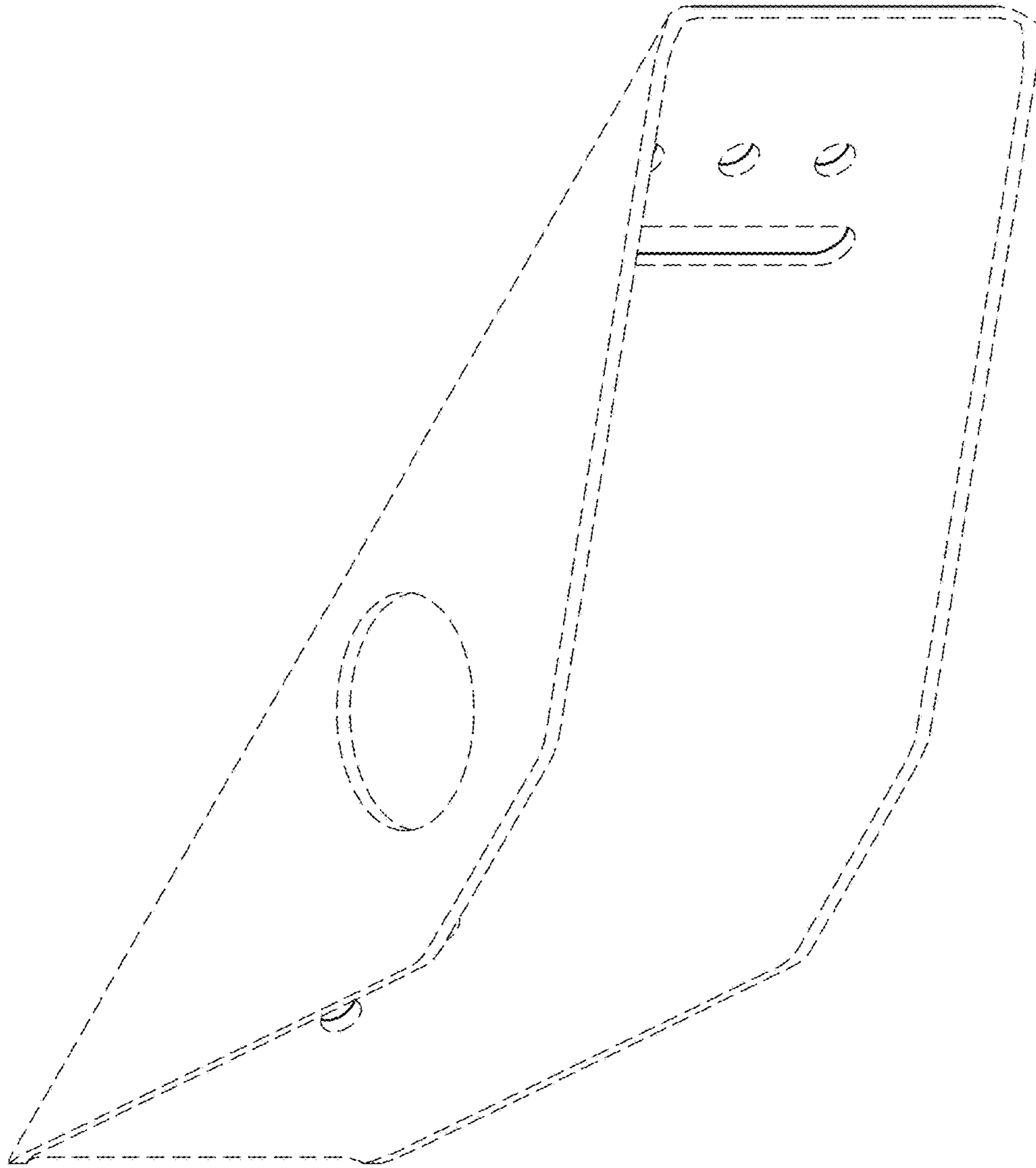

FIG. 8