



US00D807700S

(12) **United States Design Patent** (10) **Patent No.:** **US D807,700 S**
Tu (45) **Date of Patent:** **** Jan. 16, 2018**

(54) **BLENDER CONTAINER**

FOREIGN PATENT DOCUMENTS

(71) Applicant: **SharkNinja Operating LLC**, Newton, MA (US)

FR 2962023 A1 1/2012
JP S55175095 U 12/1980
WO 2016191538 A1 12/2016

(72) Inventor: **Joyce Tu**, Arlington, MA (US)

OTHER PUBLICATIONS

(73) Assignee: **SHARKNINJA OPERATING LLC**, Newton, MA (US)

International Search Report; International Application No. PCT/US2016/034287; International Filing Date: May 26, 2016; dated Jul. 18, 2016; 5 Pages.

(**) Term: **15 Years**

(Continued)

(21) Appl. No.: **29/596,920**

Primary Examiner — Ricky Pham

(22) Filed: **Mar. 13, 2017**

(74) *Attorney, Agent, or Firm* — Cantor Colburn LLP

Related U.S. Application Data

(62) Division of application No. 29/532,039, filed on Jul. 1, 2015, now Pat. No. Des. 784,761.

(57) **CLAIM**

(51) **LOC (11) Cl.** **31-00**

The ornamental design for a blender container, as shown and described.

(52) **U.S. Cl.**

USPC **D7/413**; D7/376; D7/378; D7/412

(58) **Field of Classification Search**

DESCRIPTION

USPC D7/372, 376–386, 412–413, 602, 607, D7/629, 665–666, 669, 679, 693–694
CPC A21C 1/02; A21C 1/04; A23N 1/00; A23N 1/02; A47J 43/04; A47J 43/25; A47J 43/27; A47J 43/042; A47J 43/044; A47J 43/046; A47J 43/075; A47J 43/0722; A47J 43/0727; B01F 3/00; B01F 3/0807; B01F 3/0853; B01F 13/0059; B01F 13/0064; B02C 1/08; B02C 2/04; B02C 4/42; B02C 4/142; B02C 4/143; B02C 4/423; B02C 13/1835; B28C 5/10; B28C 5/12; B28C 5/14; B28C 5/16

See application file for complete search history.

FIG. 1 is a perspective view of an embodiment of a blender container showing our new design;
FIG. 2 is a left side elevational view thereof;
FIG. 3 is a right side elevational view thereof;
FIG. 4 is a rear elevational view thereof;
FIG. 5 is a front elevational view thereof;
FIG. 6 is a top plan view thereof; and
FIG. 7 is a bottom plan view thereof.
FIG. 8 is a perspective view of an embodiment of a blender container showing our new design;
FIG. 9 is a left side elevational view thereof;
FIG. 10 is a right side elevational view thereof;
FIG. 11 is a rear elevational view thereof;
FIG. 12 is a front elevational view thereof;
FIG. 13 is a top plan view thereof; and,
FIG. 14 is a bottom plan view thereof.

(56) **References Cited**

U.S. PATENT DOCUMENTS

3,392,768 A 7/1968 Anliker
4,644,838 A 2/1987 Samson et al.
5,839,826 A 11/1998 Eubanks

The broken lines in the drawings illustrate part of the container form no part of the claimed design.

(Continued)

1 Claim, 14 Drawing Sheets

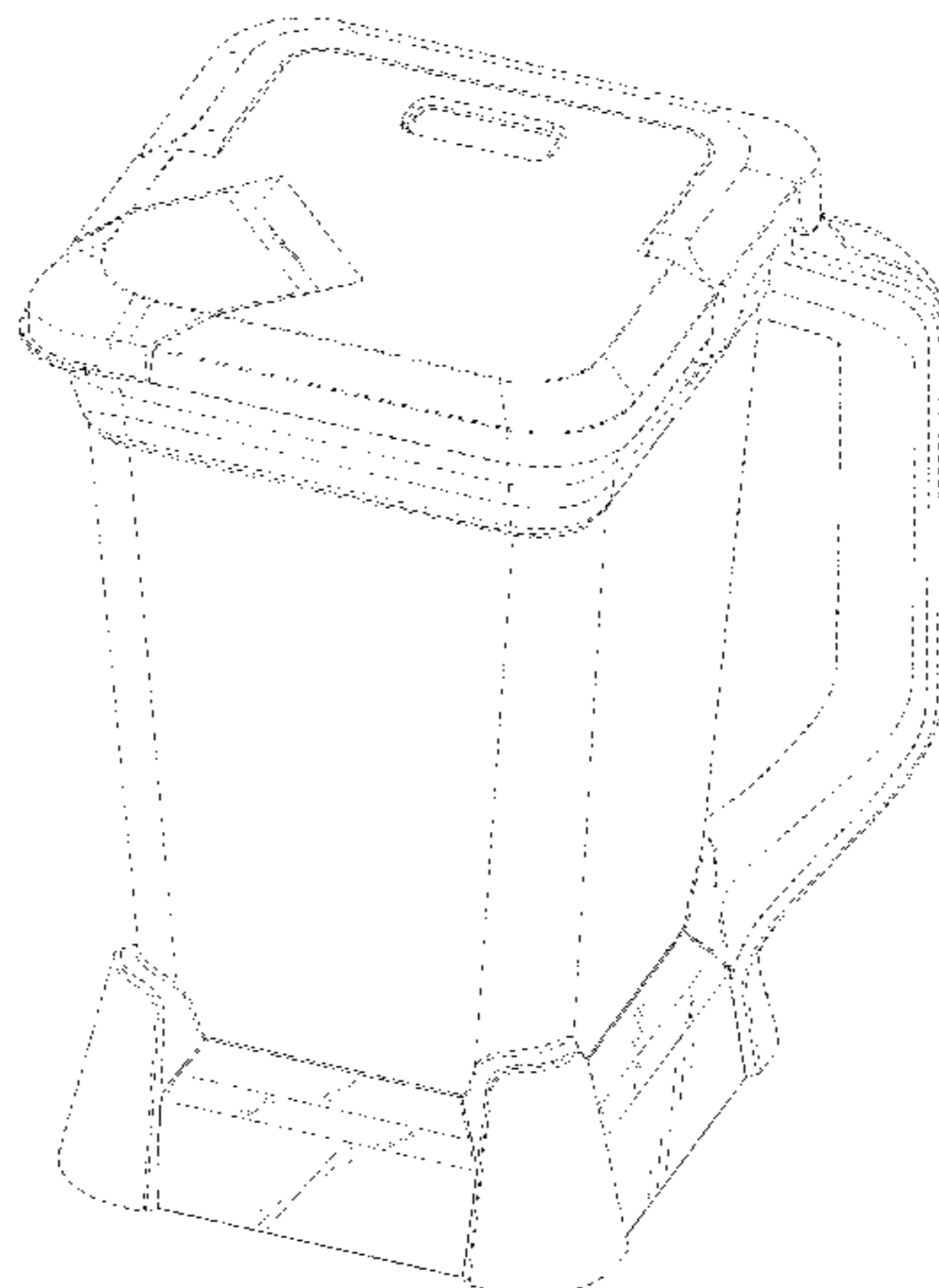

(56)

References Cited

U.S. PATENT DOCUMENTS

D424,371 S * 5/2000 Delmonte D6/610
 D437,730 S 2/2001 Littmann
 D445,644 S 7/2001 Littmann
 D480,915 S 10/2003 Kolar et al.
 D528,363 S 9/2006 Ulanski et al.
 D538,595 S * 3/2007 White D7/413
 D552,419 S 10/2007 Picozza et al.
 D577,537 S 9/2008 Lee
 D578,340 S 10/2008 Picozza et al.
 D605,462 S 12/2009 Picozza et al.
 D617,136 S 6/2010 Bock et al.
 7,753,223 B2 * 7/2010 Boozer A47J 43/0727
 220/254.7
 D621,656 S 8/2010 Ulanski et al.
 D625,141 S 10/2010 Moore
 D637,870 S 5/2011 Bock
 D638,256 S 5/2011 Wu
 D642,858 S * 8/2011 Lazzer D7/376
 D644,480 S 9/2011 Czach et al.
 D645,301 S 9/2011 Tse
 D647,367 S 10/2011 Audette et al.
 D647,368 S 10/2011 Audette et al.
 D661,947 S 6/2012 Conti et al.
 D662,359 S 6/2012 Boozer et al.
 D668,100 S 10/2012 Palermo et al.
 D677,976 S 3/2013 Palermo et al.
 D678,726 S 3/2013 Palermo et al.
 D679,543 S 4/2013 Repac
 D684,818 S * 6/2013 Lee D7/376
 D694,573 S 12/2013 Norland et al.
 D702,999 S * 4/2014 Audette D7/376
 D705,606 S 5/2014 Coakley et al.
 D711,682 S 8/2014 Norland et al.
 8,834,015 B2 * 9/2014 White A47J 43/046
 241/282.2
 D715,602 S 10/2014 Schillheim
 D730,682 S * 6/2015 Tu D7/376
 D730,683 S 6/2015 Tu
 D733,488 S 7/2015 Tu
 D742,172 S 11/2015 Dickson, Jr. et al.
 D746,630 S 1/2016 Ji
 D755,003 S 5/2016 Palermo et al.
 9,420,915 B2 * 8/2016 Dickson, Jr. A47J 43/046
 D765,465 S 9/2016 Du
 D769,061 S * 10/2016 Diderotto D7/376
 D771,999 S 11/2016 Kettavong et al.
 D783,340 S 4/2017 Palermo et al.
 D783,354 S * 4/2017 Smith D7/376
 D784,069 S 4/2017 Blaise
 D784,761 S * 4/2017 Tu D7/376
 D785,403 S * 5/2017 Smith D7/376
 D786,615 S 5/2017 Tsai
 2006/0018189 A1 1/2006 Chang
 2006/0198241 A1 9/2006 Krishnachaitanya et al.
 2007/0144326 A1 6/2007 de Buyer

2012/0024993 A1 2/2012 Audette et al.
 2012/0027902 A1 2/2012 Audette et al.
 2014/0165408 A1 6/2014 Schillheim
 2016/0331182 A1 11/2016 Golino

OTHER PUBLICATIONS

Notice of Allowance; U.S. Appl. No. 29/532,039, filed Jul. 1, 2015; Blender Container; dated Oct. 24, 2016; 7 Pages.
 Notice of Allowance; U.S. Appl. No. 29/532,039, filed Jul. 1, 2015; Blender Container; dated Dec. 14, 2016; 9 Pages.
 Restriction Requirement; U.S. Appl. No. 29/532,039, filed Jul. 1, 2015; Blender Container; dated Aug. 9, 2016; 6 Pages.
 Written Opinion of the International Searching Authority; International Application No. PCT/US2016/034287; International Filing Date: May 26, 2016; dated Jul. 18, 2016; 4 Pages.
 International Search Report; International Application No. PCT/US2017/016364; International Filing Date: Feb. 3, 2017; dated May 10, 2017; 7 Pages.
 Notice of Allowance; U.S. Appl. No. 29/571,229, filed Jul. 15, 2016; Blender Base; dated Jun. 5, 2017; 13 Pages.
 Notice of Completion of Formalities for Patent Register and Notice of Grant of Design Patent Right; Chinese Application No. 2017300123877; dated Apr. 28, 2017; 5 Pages.
 Notice of Completion of Formalities for Patent Register and Notice of Grant of Design Patent Right; Chinese Application No. 2017300139659; dated Jun. 20, 2017; 5 Pages.
 Notice of Completion of Formalities for Patent Register and Notice of Grant of Design Patent Right; Chinese Application No. 2017300140139; dated Apr. 28, 2017; 5 Pages.
 Notice of Completion of Formalities for Patent Register and Notice of Grant of Design Patent Right; Chinese Application No. 2017300161830; dated May 15, 2017; 5 Pages.
 Notice of Completion of Formalities for Patent Register and Notice of Grant of Design Patent Right; Chinese Application No. 2017300161968; dated Jun. 16, 2017; 5 Pages.
 Notice of Decision for Design Registration; Korean Application No. 30-2017-0002350; dated Jun. 20, 2017; 6 Pages.
 Notice of Decision for Design Registration; Korean Application No. 30-2017-0002351; dated Jun. 20, 2017; 6 Pages.
 Notice of Decision for Design Registration; Korean Application No. 30-2017-0002352; dated Jun. 20, 2017; 6 Pages.
 Requirement for Restriction/Election; U.S. Appl. No. 29/571,224, filed Jul. 15, 2016; Food Processor Container and Top Thereof; dated Jul. 5, 2017; 12 Pages.
 Requirement for Restriction/Election; U.S. Appl. No. 29/571,226, filed Jul. 15, 2016; Food Processor Container and Top Thereof; dated Jul. 5, 2017; 12 Pages.
 Requirement for Restriction/Election; U.S. Appl. No. 29/571,227, filed Jul. 15, 2016; Blender Container; dated Jul. 3, 2017; 12 Pages.
 Written Opinion of the International Searching Authority; International Application No. PCT/US2017/016364; International Filing Date: Feb. 3, 2017; dated May 10, 2017; 8 Pages.

* cited by examiner

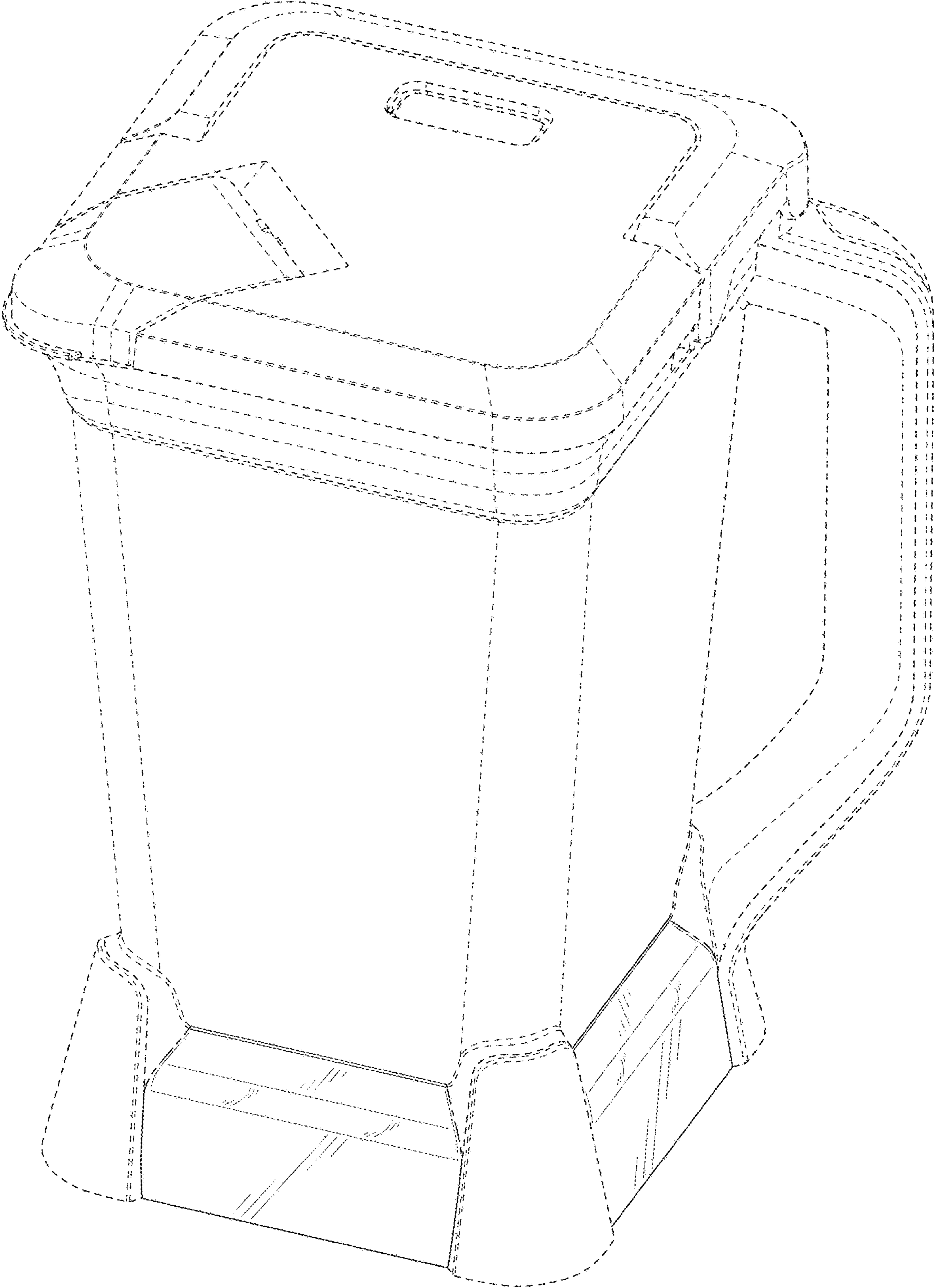

FIG. 1

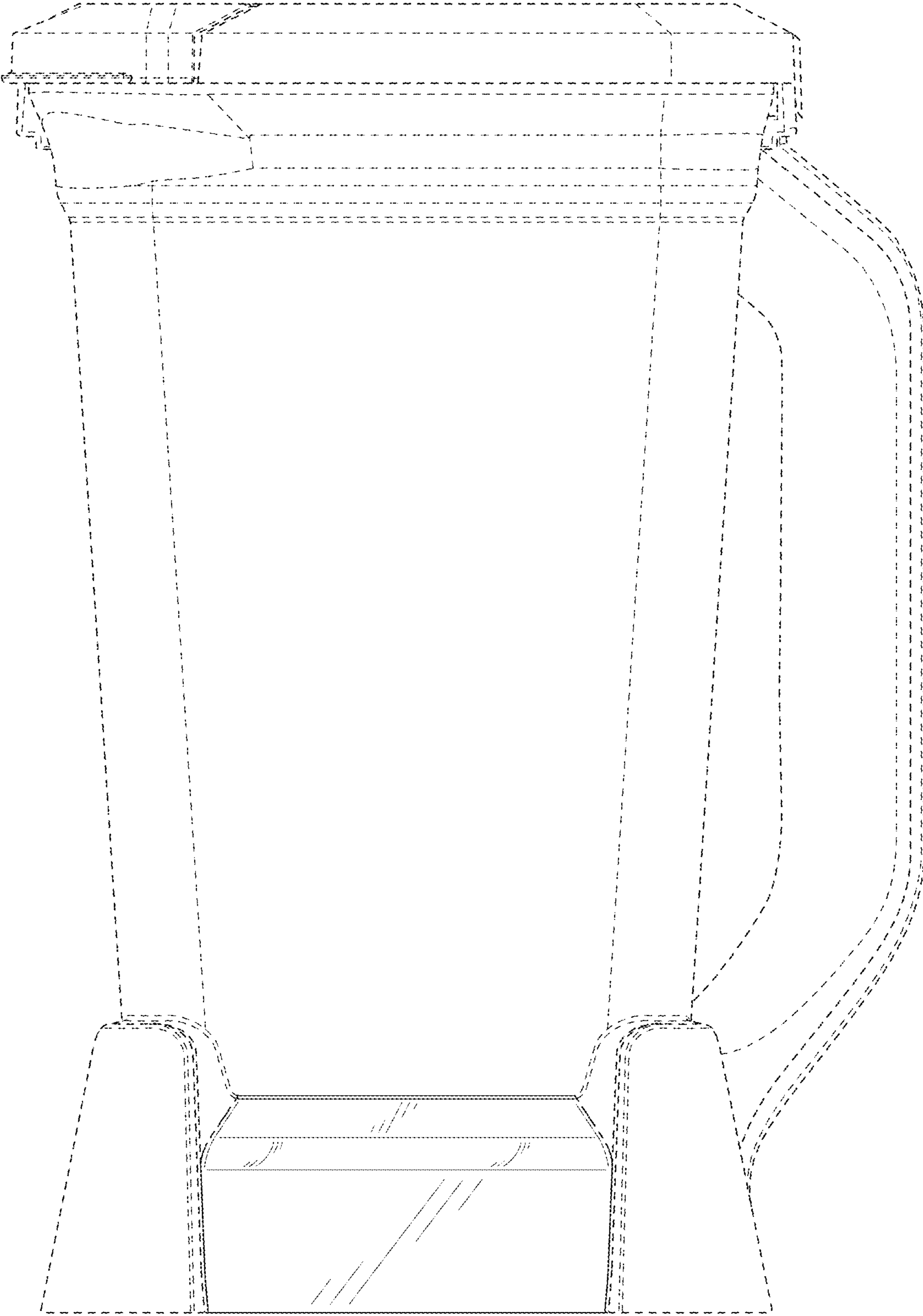

FIG. 2

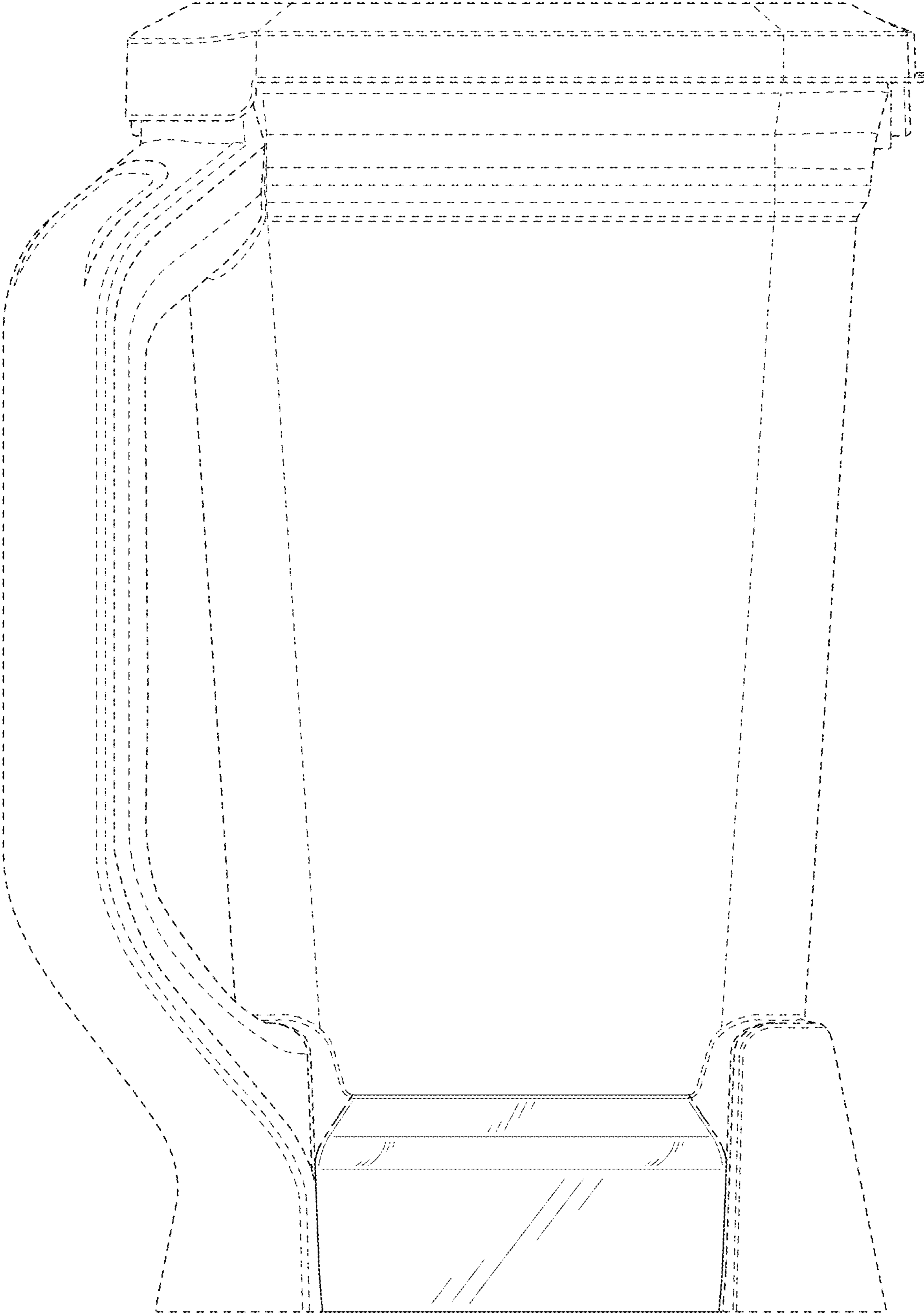

FIG. 3

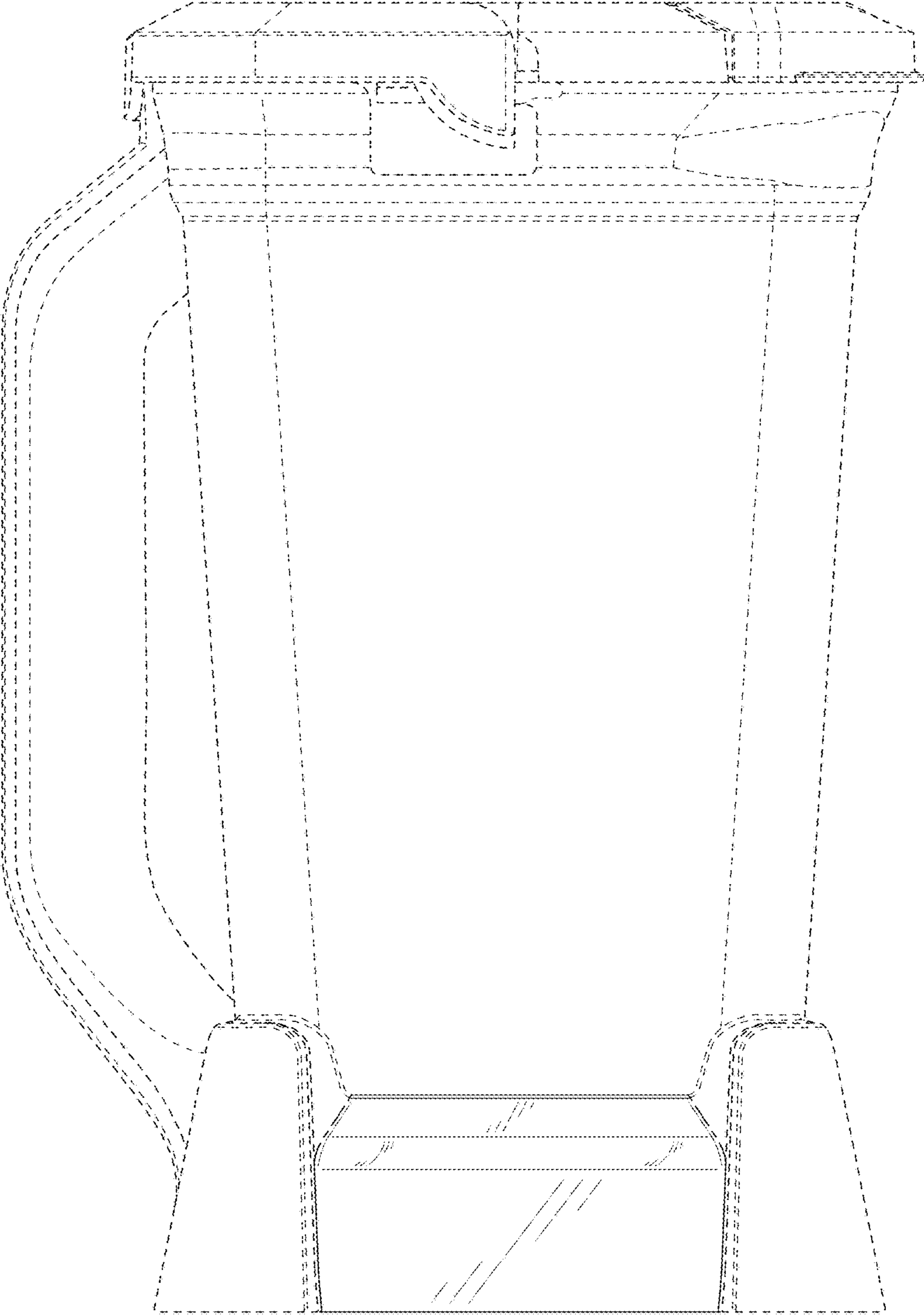

FIG. 4

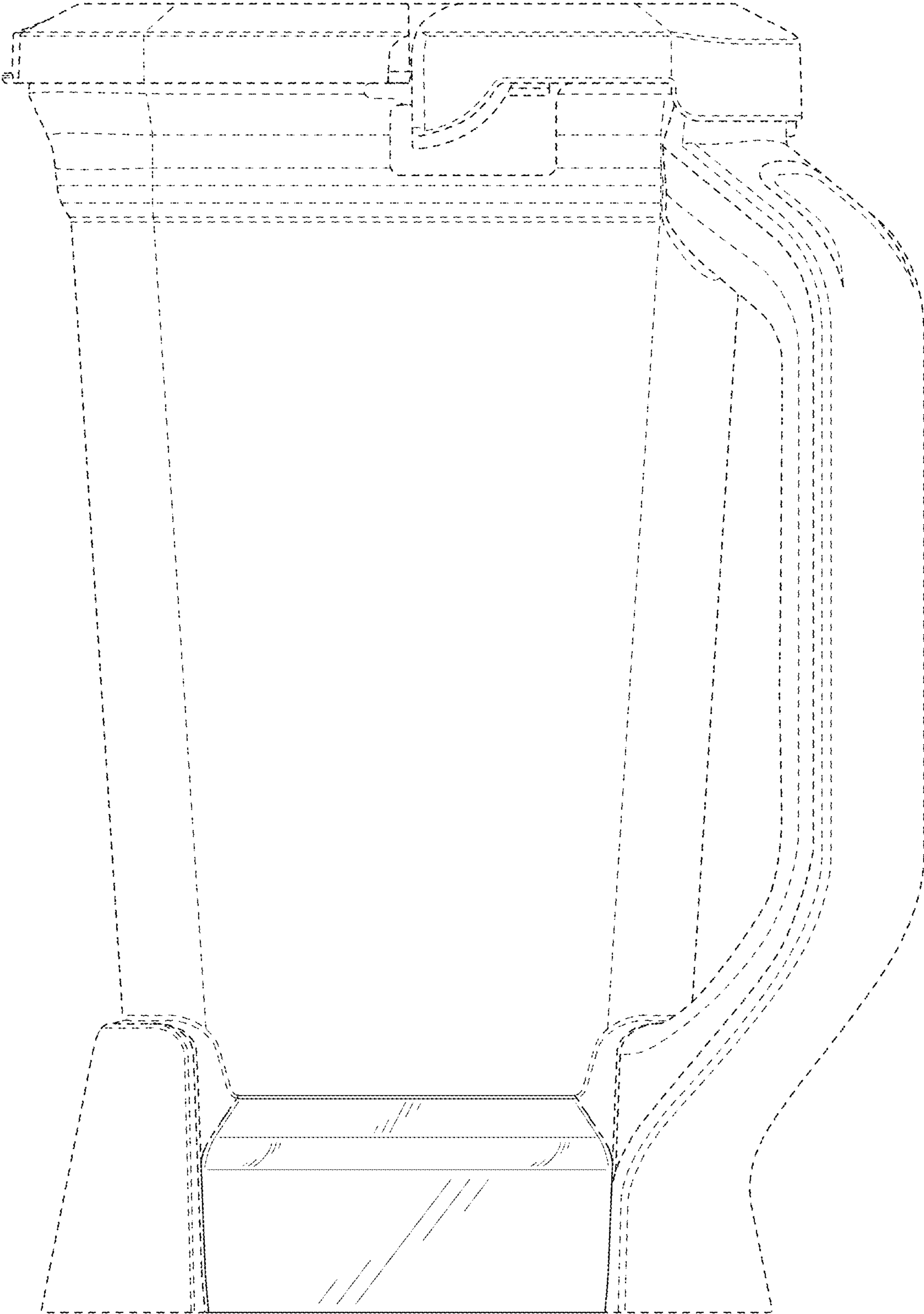

FIG. 5

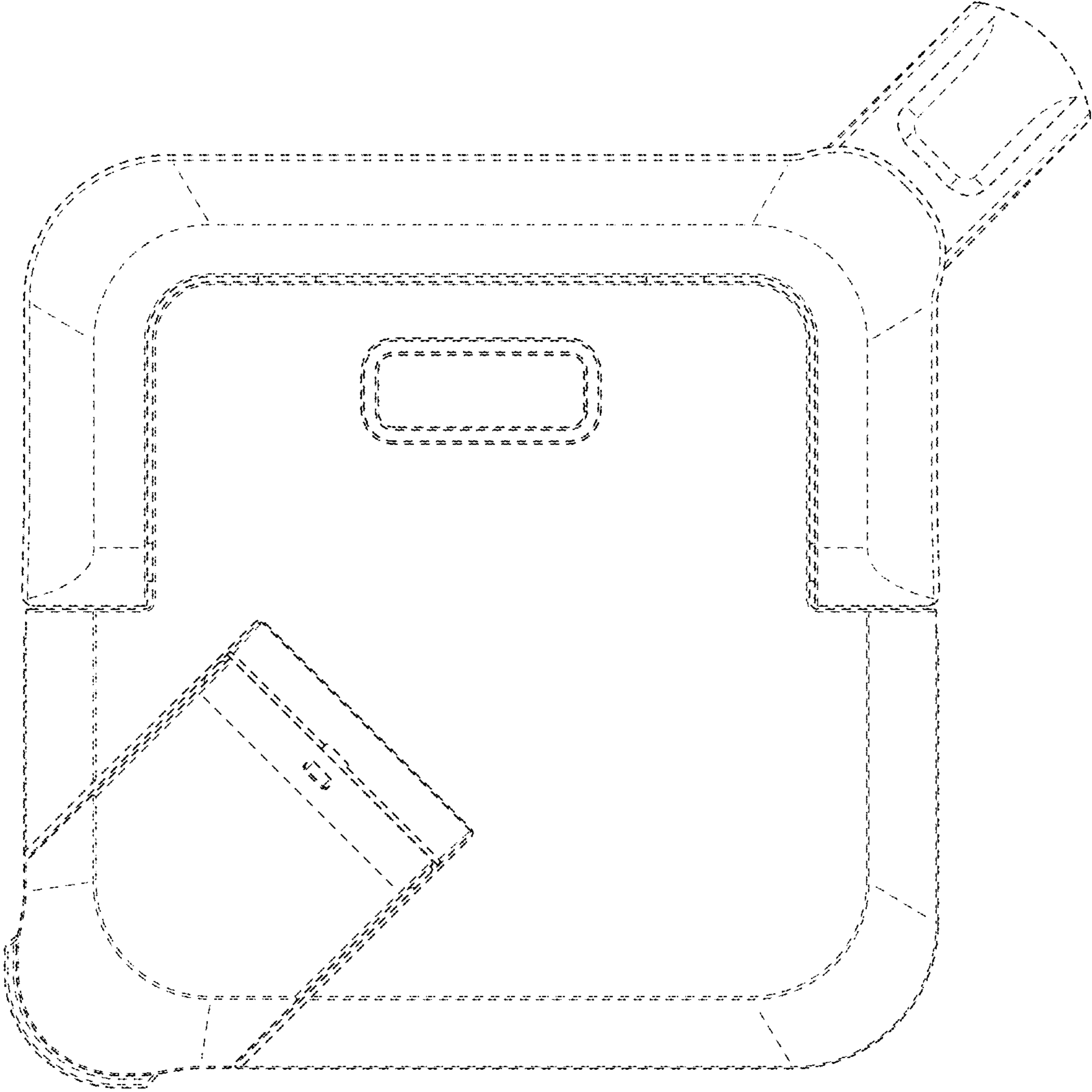

FIG. 6

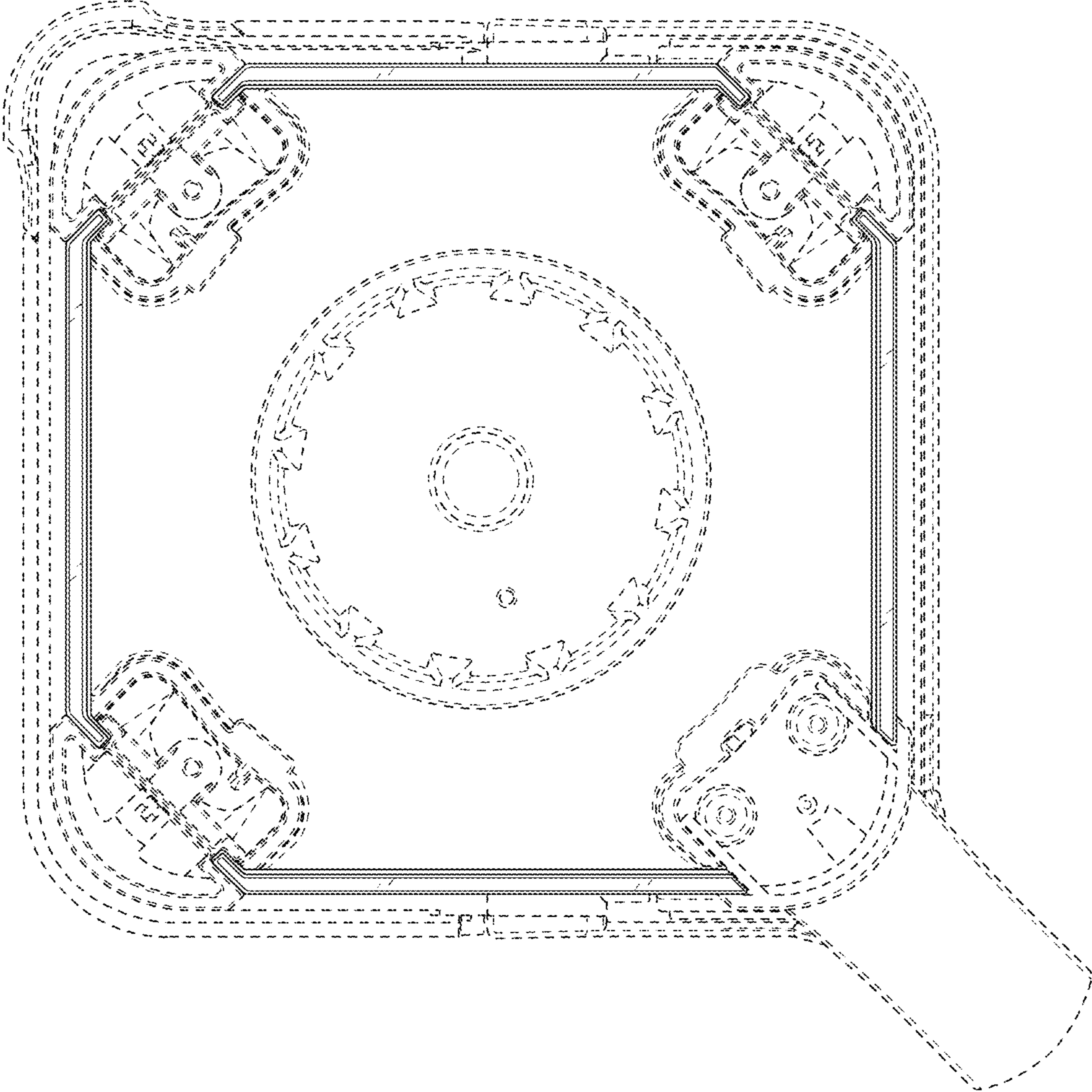

FIG. 7



FIG. 8

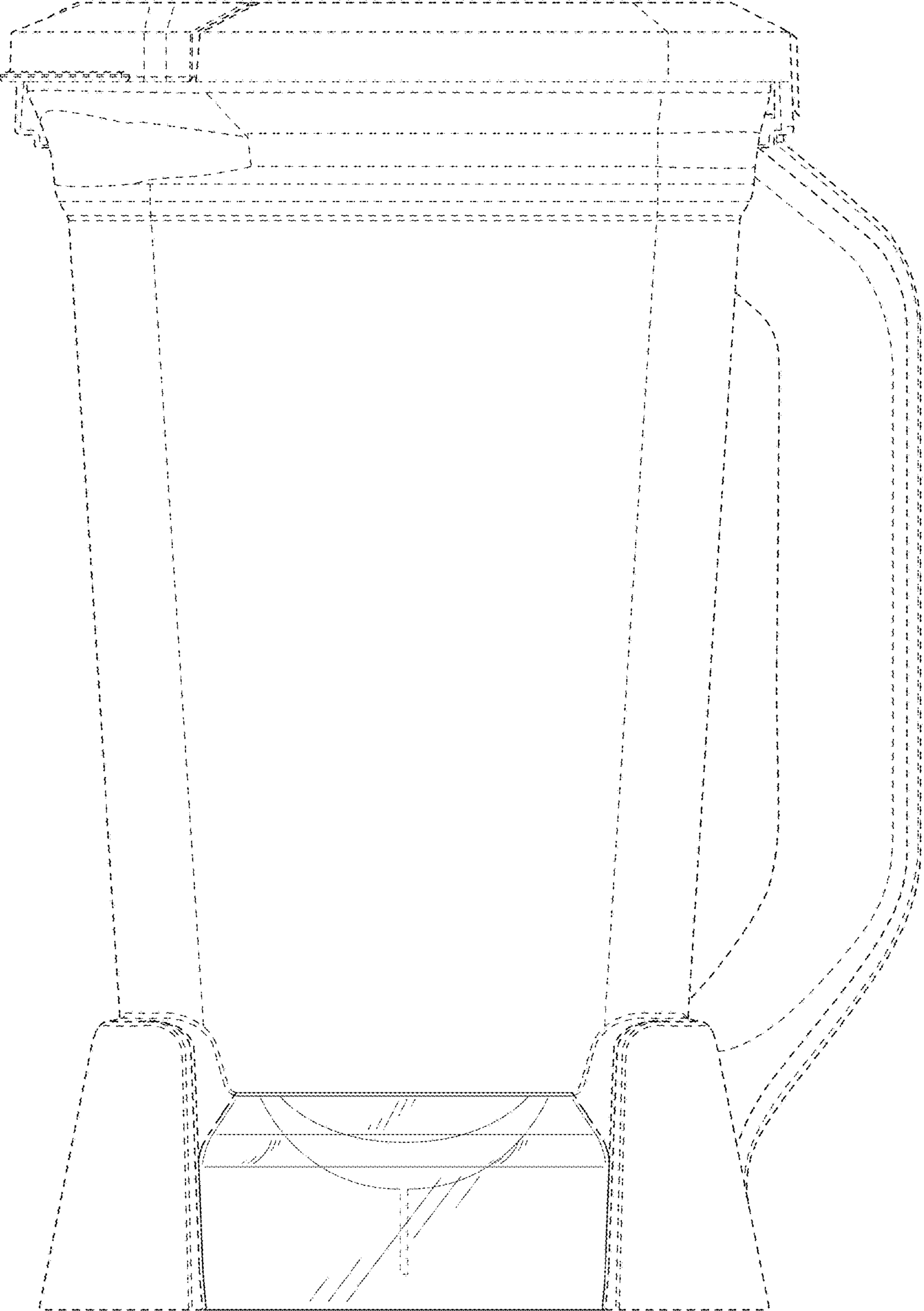

FIG. 9

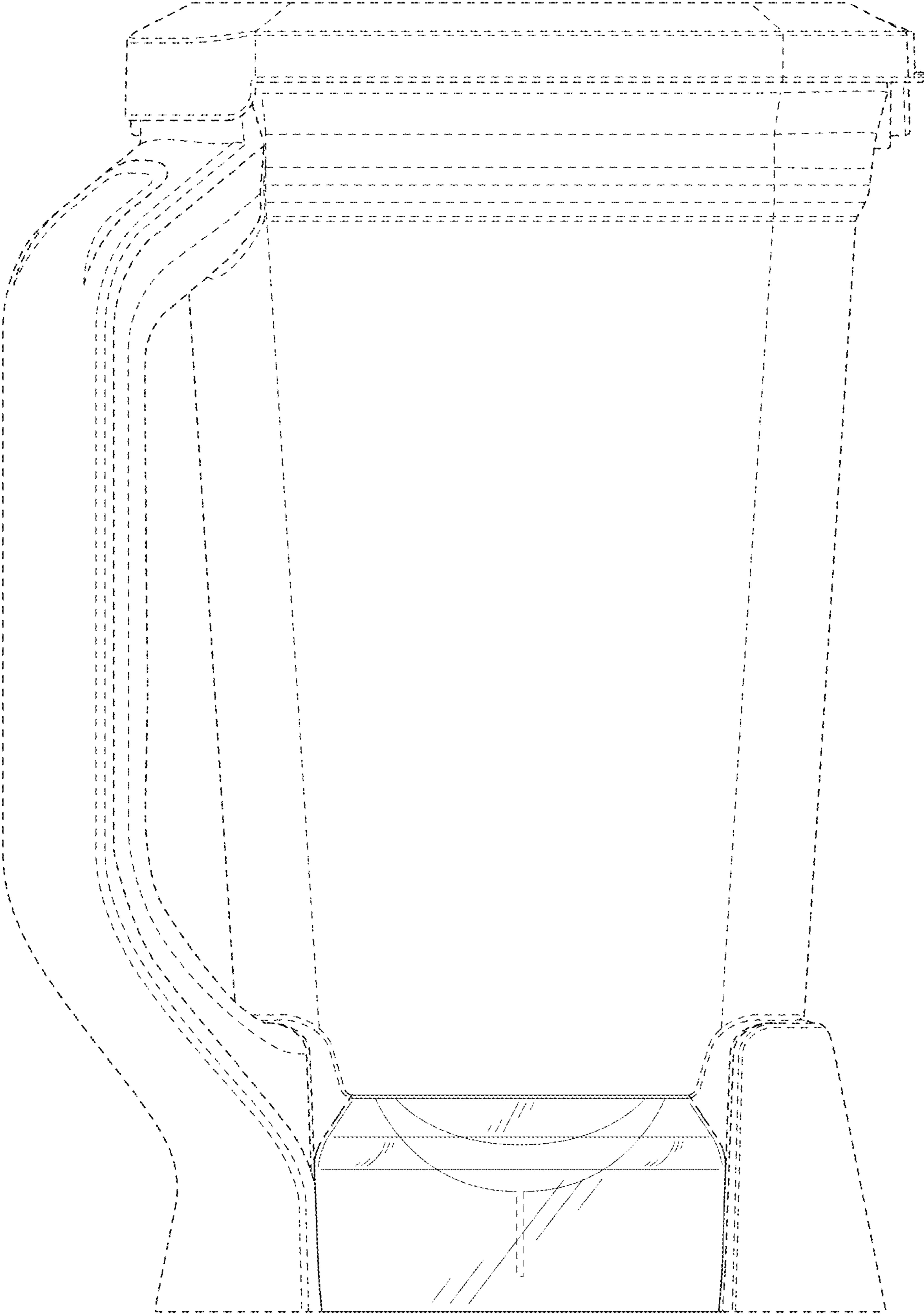

FIG. 10

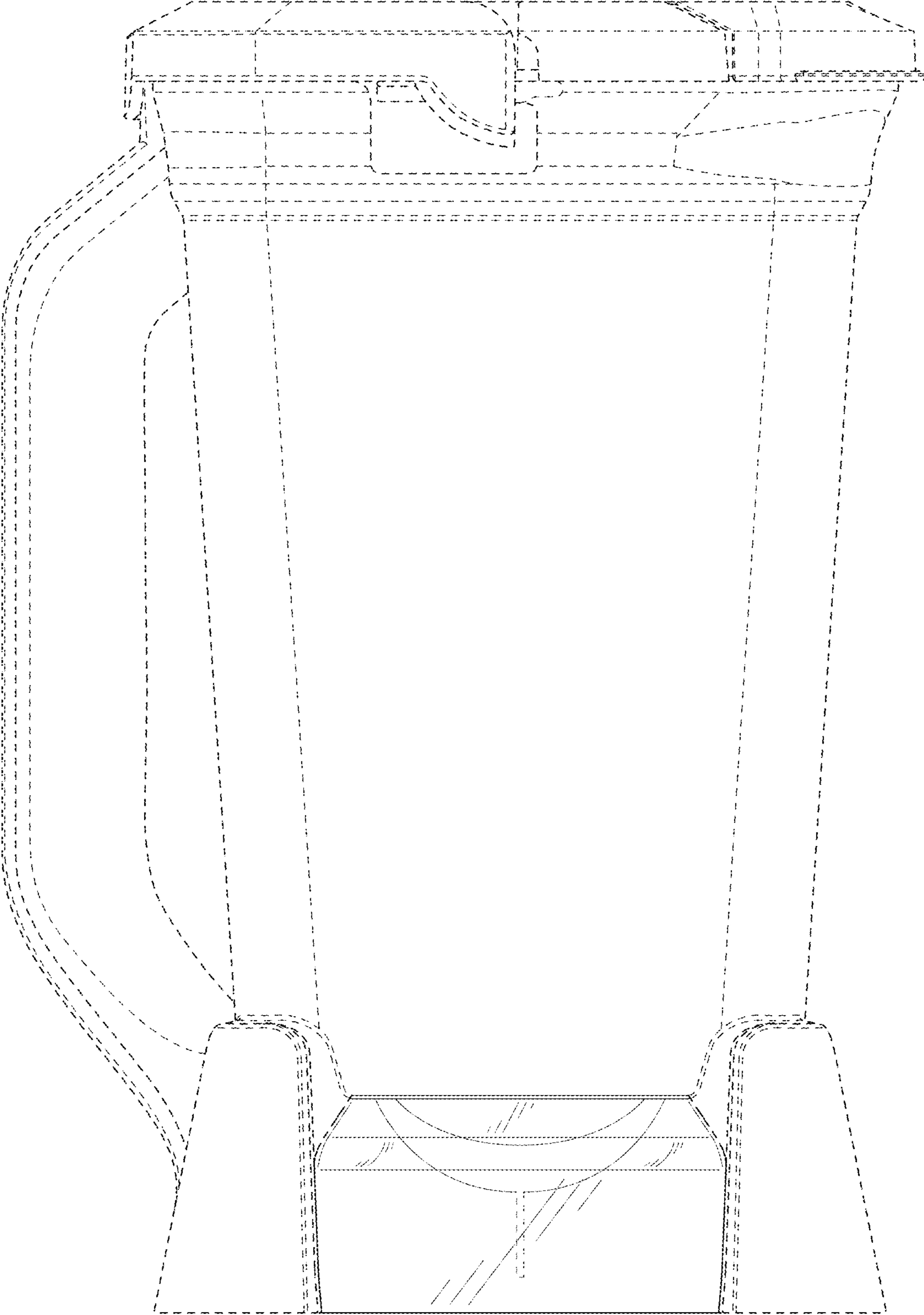

FIG. 11

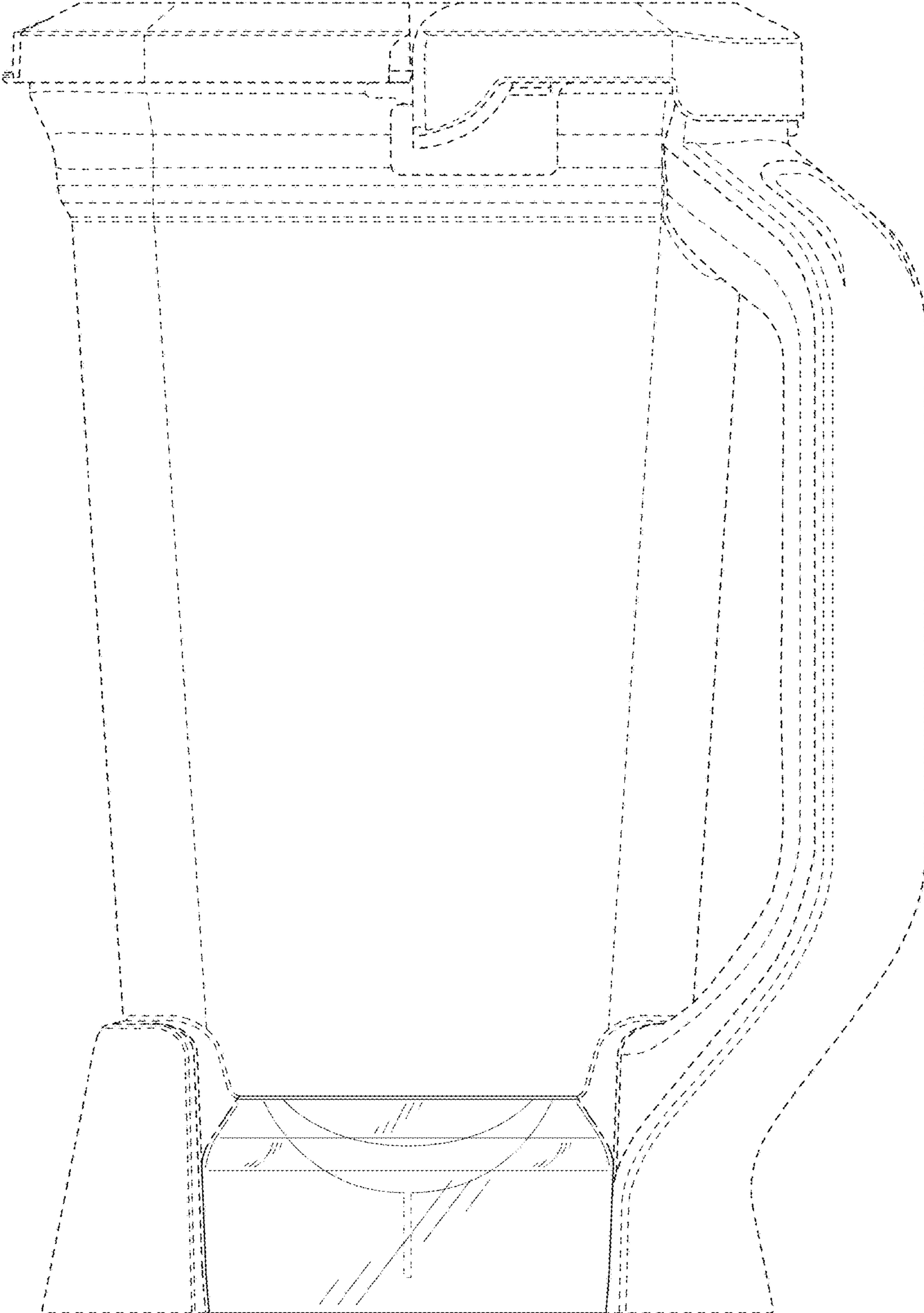

FIG. 12

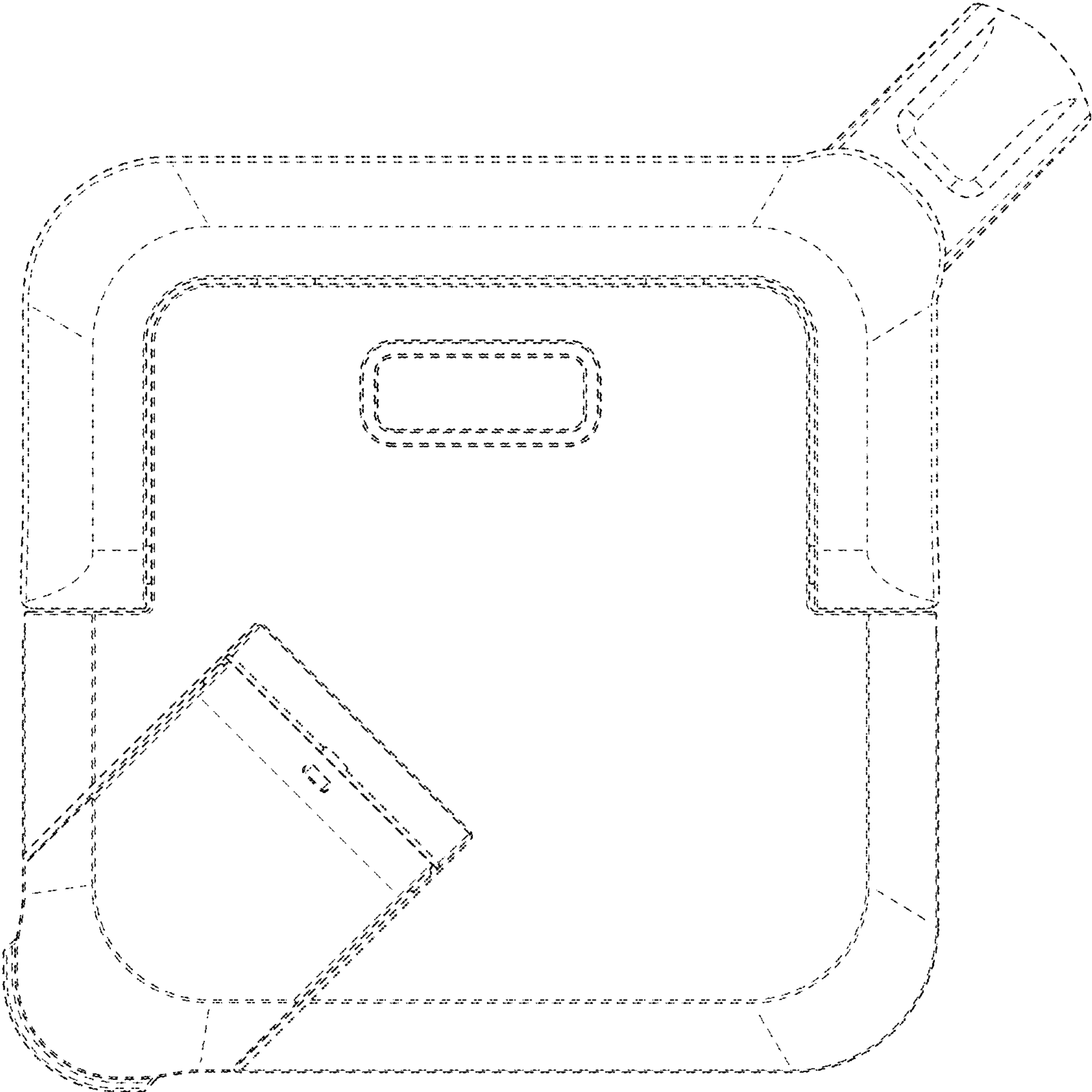

FIG. 13

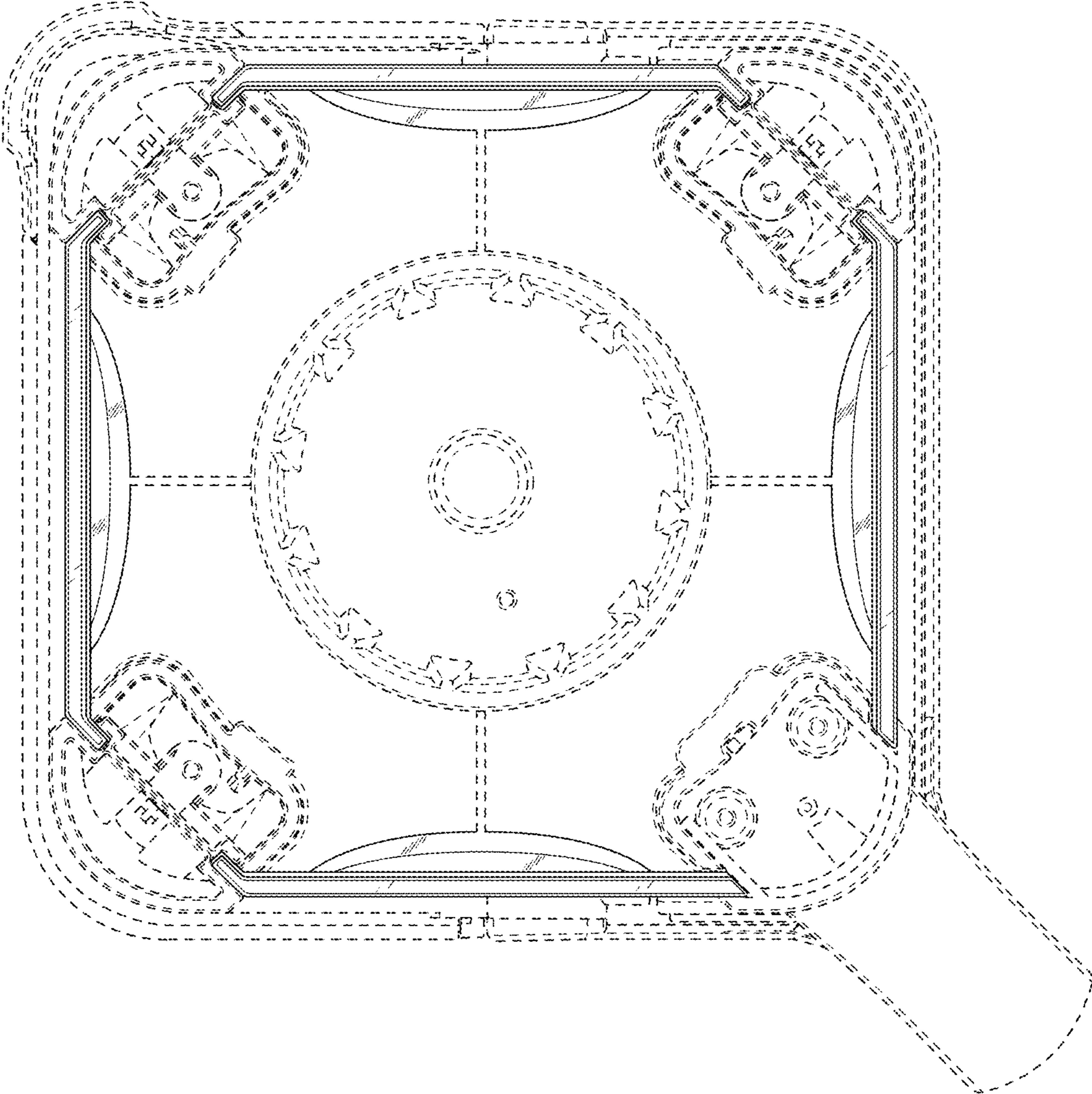

FIG. 14