



US00D807642S

(12) **United States Design Patent**
Greenwood

(10) **Patent No.:** **US D807,642 S**

(45) **Date of Patent:** **** Jan. 16, 2018**

(54) **TRAY WITH DIVIDERS**

(71) Applicant: **YouCopia Products Inc**, Chicago, IL
(US)

(72) Inventor: **Mark Greenwood**, Arlington Hts., IL
(US)

(73) Assignee: **YOUCOPIA PRODUCTS INC.**,
Chicago, IL (US)

(**) Term: **15 Years**

(21) Appl. No.: **29/579,758**

(22) Filed: **Oct. 3, 2016**

(51) **LOC (11) Cl.** **03-01**

(52) **U.S. Cl.**
USPC **D3/313**

(58) **Field of Classification Search**
USPC D3/303–315, 318–319, 328; D7/600.1,
D7/601–602, 701
CPC B65D 1/00; B65D 1/34; B65D 1/36
See application file for complete search history.

(56) **References Cited**

U.S. PATENT DOCUMENTS

D280,933 S * 10/1985 McLaughlin D24/229
D480,736 S * 10/2003 Wright D15/90
D537,633 S * 3/2007 Marnell, II D3/313

D563,166 S * 3/2008 Woolfolk D7/504
D605,896 S * 12/2009 Zalewski D7/553.1
D706,493 S * 6/2014 Hansen D30/121
D733,990 S * 7/2015 Miggels D34/35
D752,392 S * 3/2016 Maas D7/553.1
D789,690 S * 6/2017 Foley D3/310

* cited by examiner

Primary Examiner — Kelley Donnelly

(74) *Attorney, Agent, or Firm* — Lowe Graham Jones
PLLC

(57) **CLAIM**

I claim the ornamental design for the tray with dividers, as shown and described.

DESCRIPTION

FIG. 1 is a top perspective view of the tray with dividers, showing my new design.

FIG. 2 is a bottom perspective view of the tray with dividers.

FIG. 3 is a front view of the tray with dividers.

FIG. 4 is a rear view of the tray with dividers.

FIG. 5 is a left side view of the tray with dividers.

FIG. 6 is a right side view of the tray with dividers.

FIG. 7 is a top view of the tray with dividers; and,

FIG. 8 is a bottom view of the tray with dividers.

The broken lines depict portions of the article that form no part of the claimed design. The outer broken line at the bottom of the tray in FIGS. 2 and 8 represents a boundary such that the interior of the rectangular broken line forms no part of the claimed design.

1 Claim, 8 Drawing Sheets

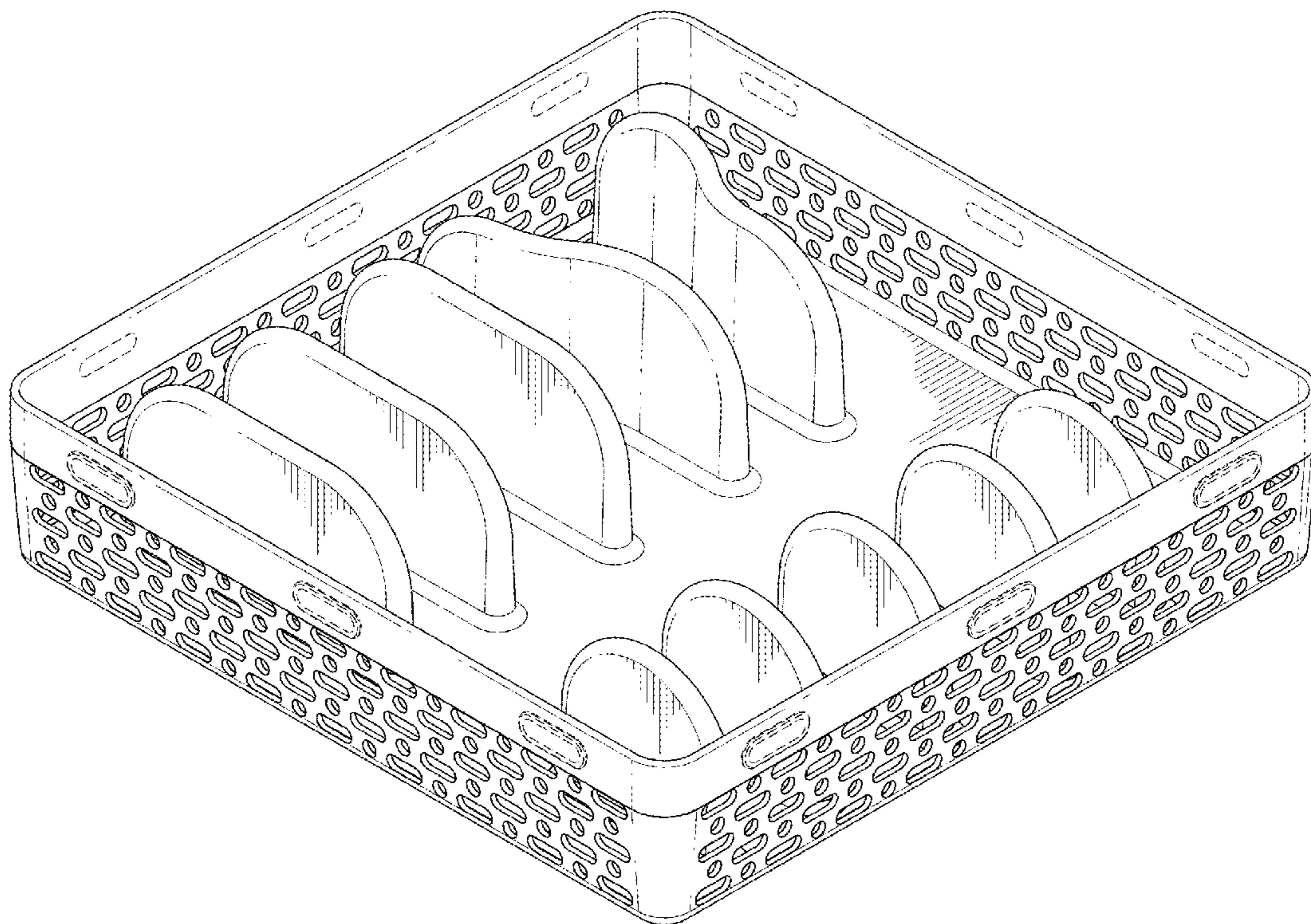

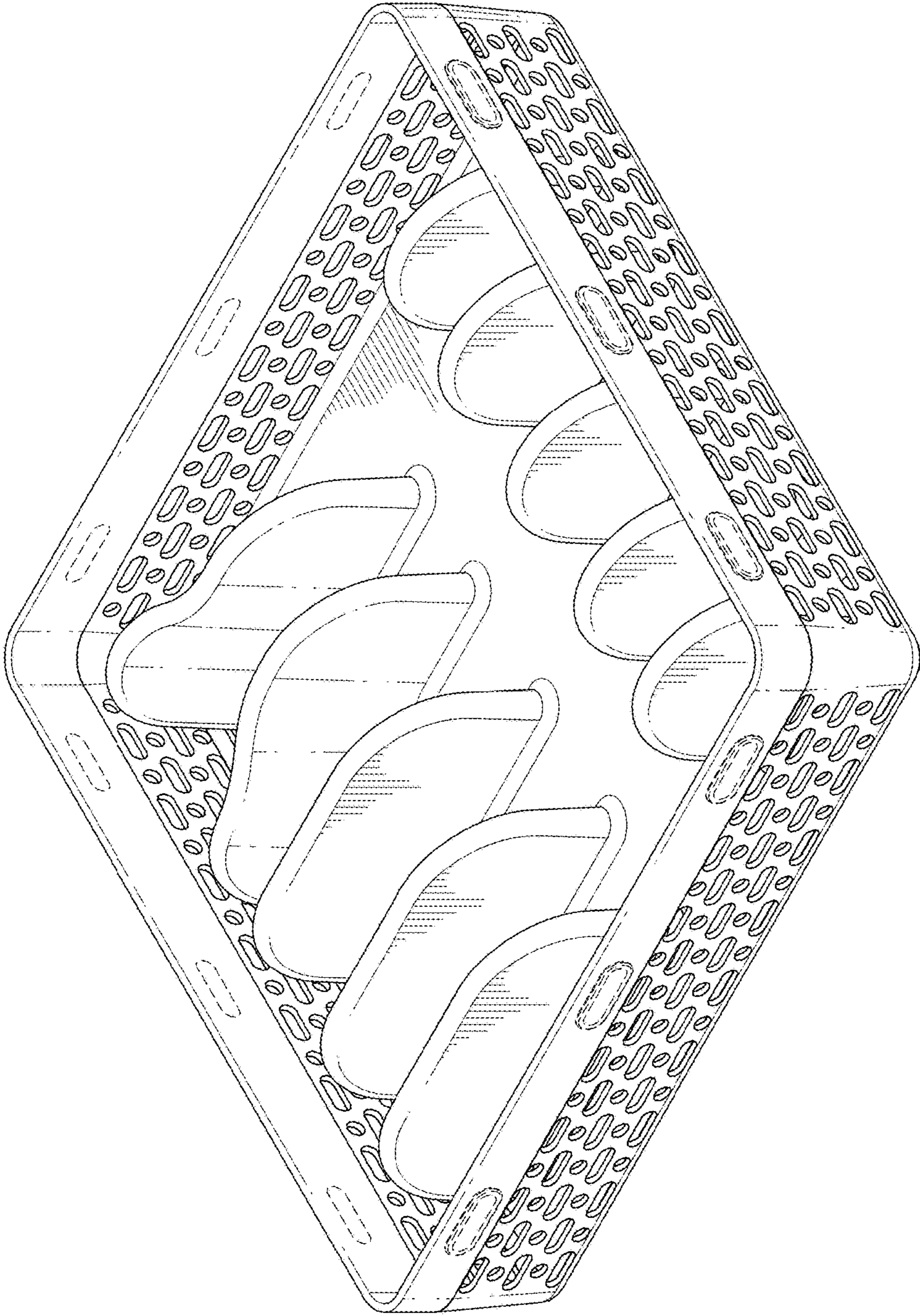

FIG. 1

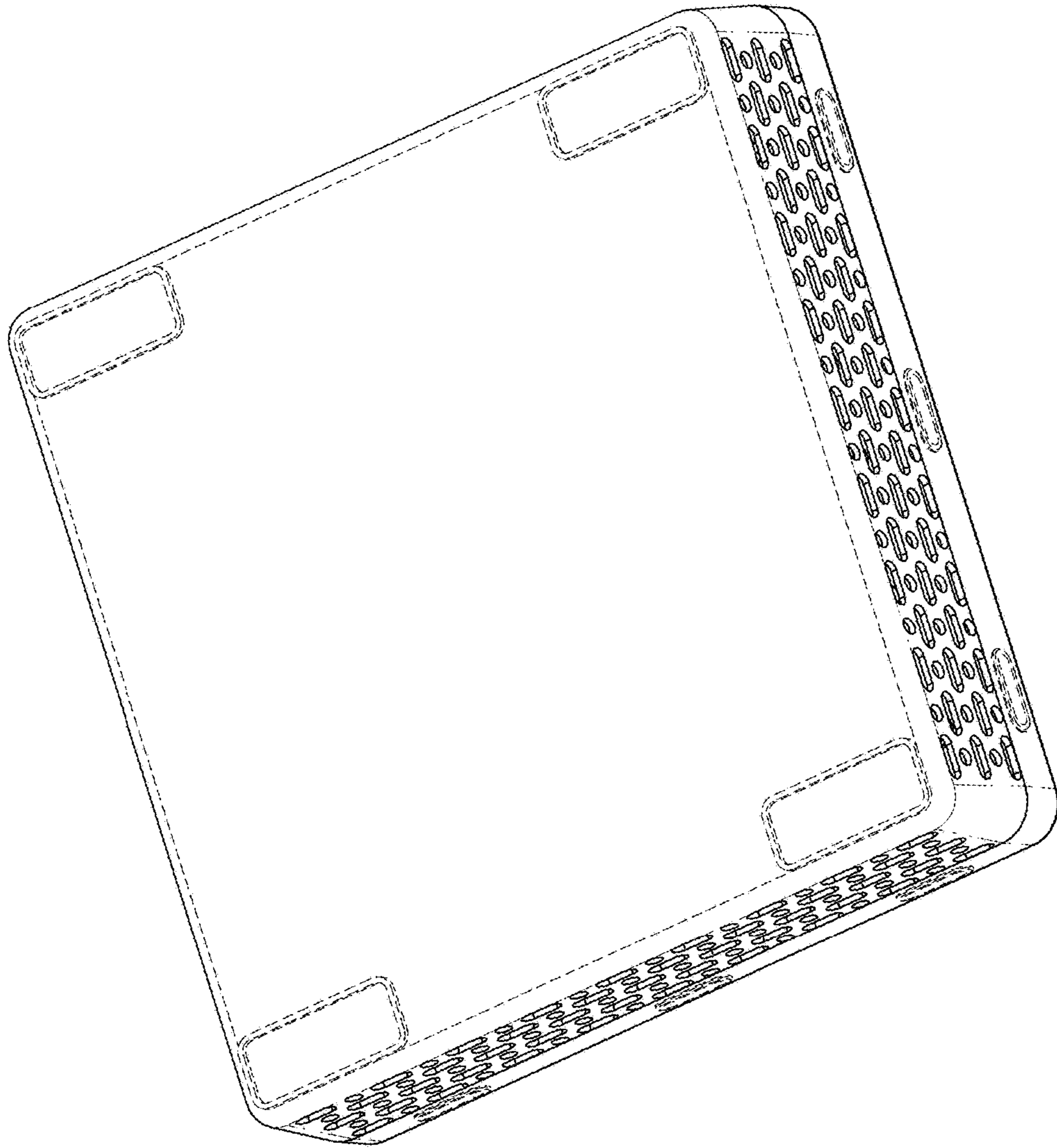

FIG. 2

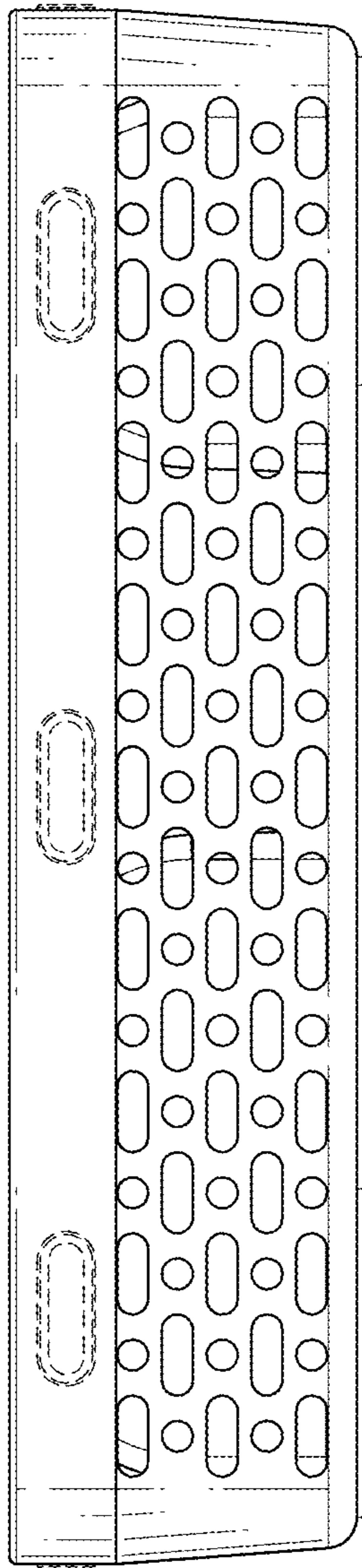

FIG. 3

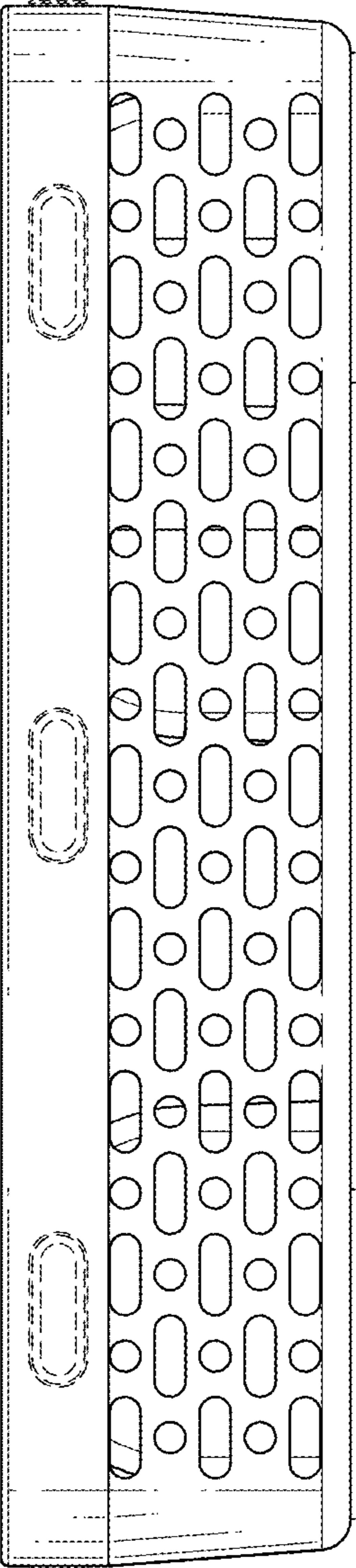

FIG. 4

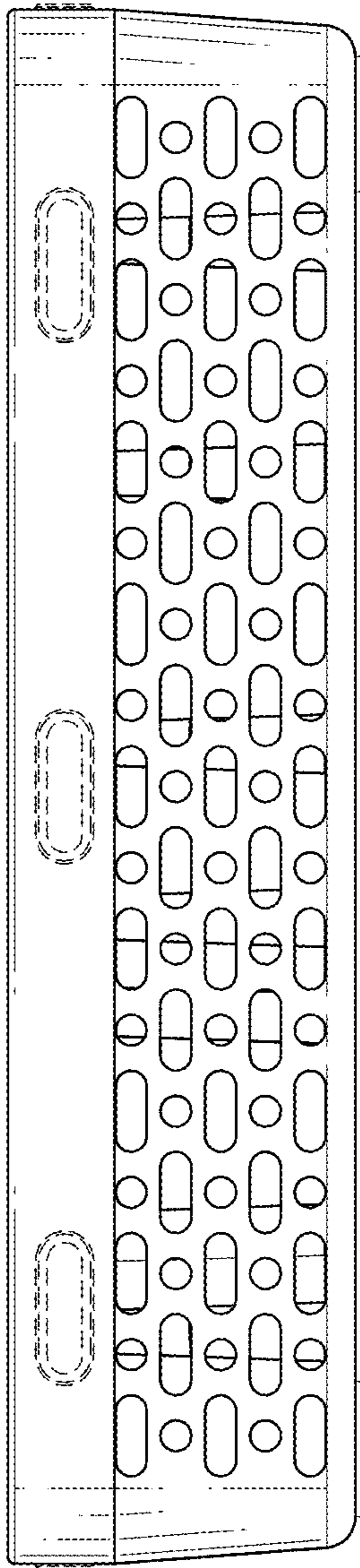

FIG. 5

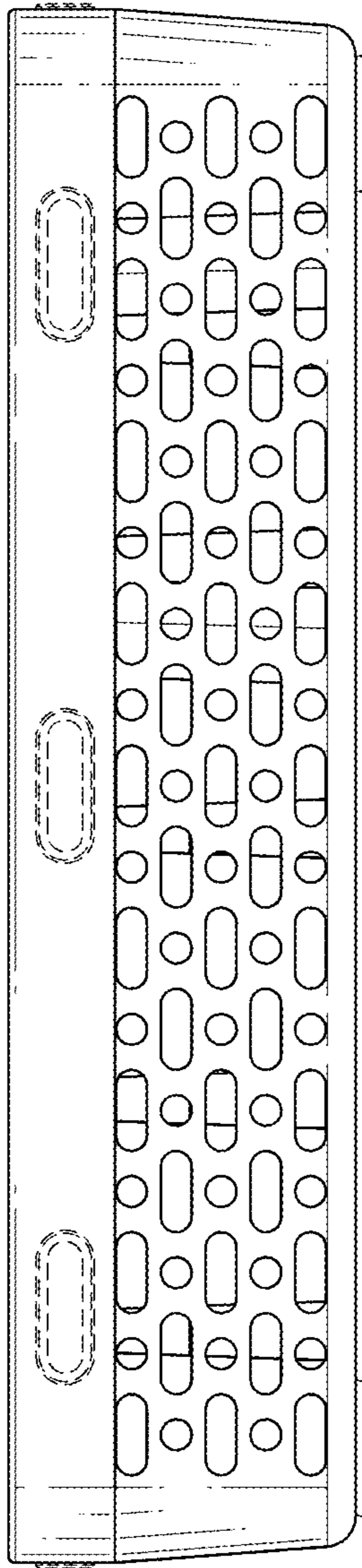

FIG. 6

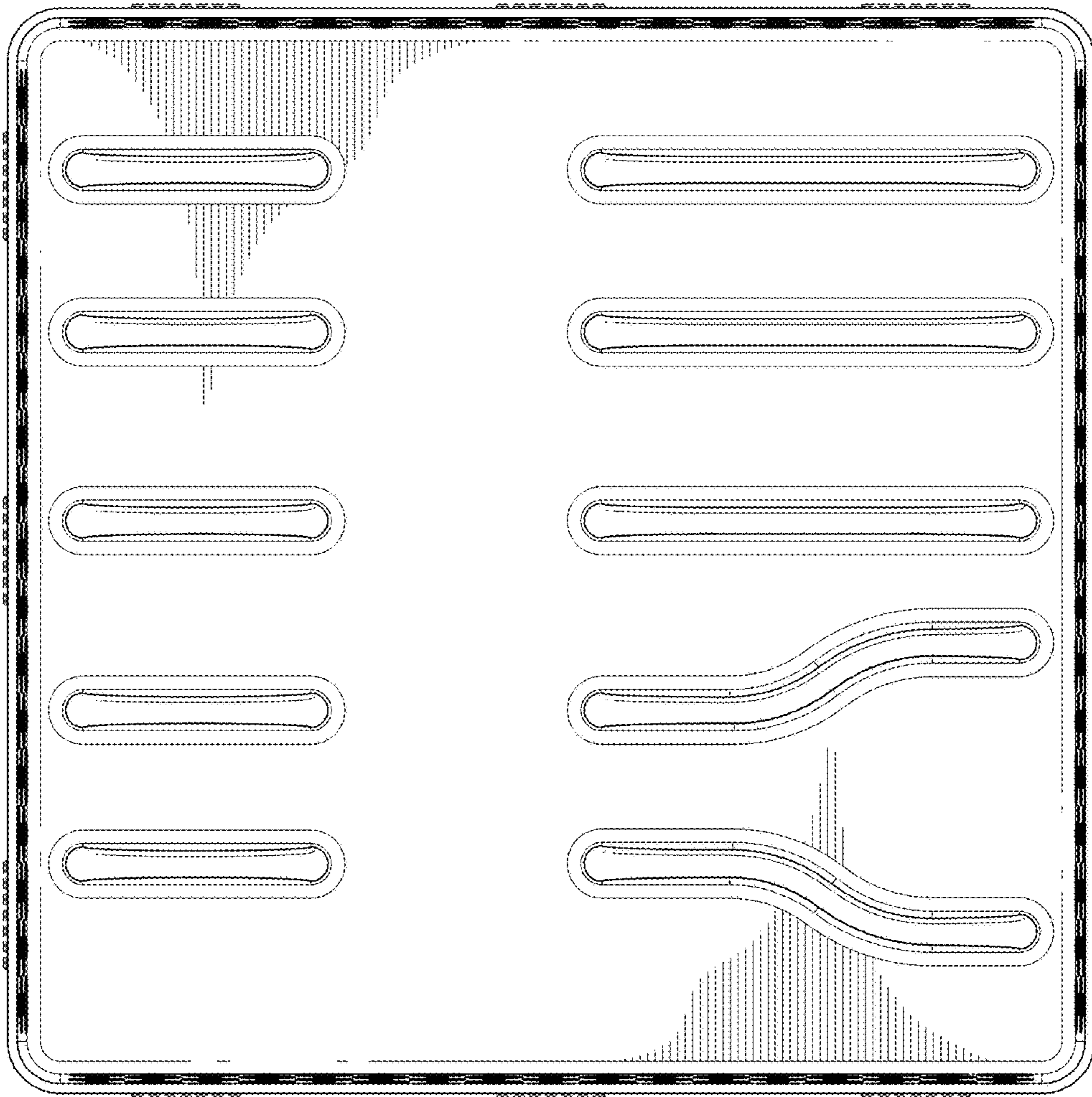

FIG. 7

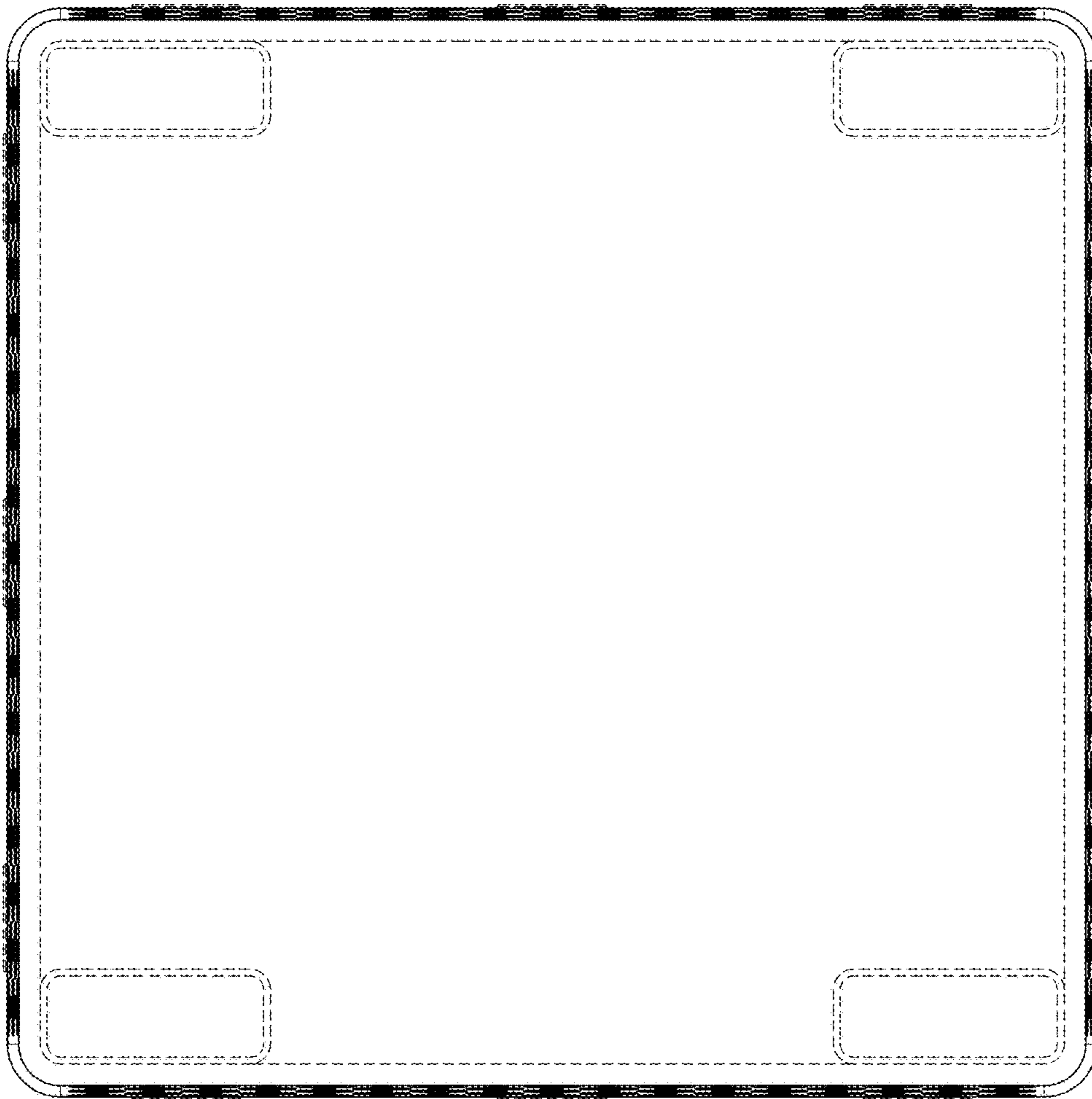

FIG. 8