



US00D807565S

(12) **United States Design Patent** (10) **Patent No.:** **US D807,565 S**  
**Johnson** (45) **Date of Patent:** **\*\* Jan. 9, 2018**

(54) **ELEPHANT-SHAPED NIGHTLIGHT**

D648,889 S \* 11/2011 Feinberg ..... D26/98  
D683,889 S \* 6/2013 Tyler ..... D26/98

(71) Applicant: **London Johnson, Inc.**, Fishersville, VA (US)

\* cited by examiner

(72) Inventor: **Brian P. Johnson**, Fishersville, VA (US)

*Primary Examiner* — Brian N. Vinson

(74) *Attorney, Agent, or Firm* — Perkins Coie LLP

(73) Assignee: **London Johnson, Inc.**, Fishersville, VA (US)

(57) **CLAIM**

The ornamental design for an elephant-shaped nightlight, as shown and described.

(\*\*) Term: **15 Years**

**DESCRIPTION**

(21) Appl. No.: **29/584,731**

(22) Filed: **Nov. 16, 2016**

(51) **LOC (11) Cl.** ..... **26-03**

(52) **U.S. Cl.**  
USPC ..... **D26/98**

(58) **Field of Classification Search**  
USPC ..... D26/93, 98; D11/131, 157, 158;  
D21/576, 616  
CPC . F21S 6/002; F21W 2101/00; F21W 2121/00;  
F21W 2131/30  
See application file for complete search history.

FIG. 1 is a perspective view of an elephant-shaped nightlight showing my design, as viewed from the top and front.  
FIG. 2 is a front profile view of the elephant-shaped nightlight showing my design.  
FIG. 3 is a back profile view of the elephant-shaped nightlight showing my design.  
FIG. 4 is a first side profile view of the elephant-shaped nightlight showing my design.  
FIG. 5 is an opposite second side profile view of the elephant-shaped nightlight showing my design.  
FIG. 6 is a top plan view of the elephant-shaped nightlight showing my design; and,  
FIG. 7 is a bottom plan view of the elephant-shaped nightlight showing my design.  
The details shown in broken lines illustrate features that form no part of the claimed design.

(56) **References Cited**

**U.S. PATENT DOCUMENTS**

D203,131 S \* 12/1965 Zeldman ..... D26/98  
D243,710 S \* 3/1977 Angeles ..... D11/158

**1 Claim, 4 Drawing Sheets**

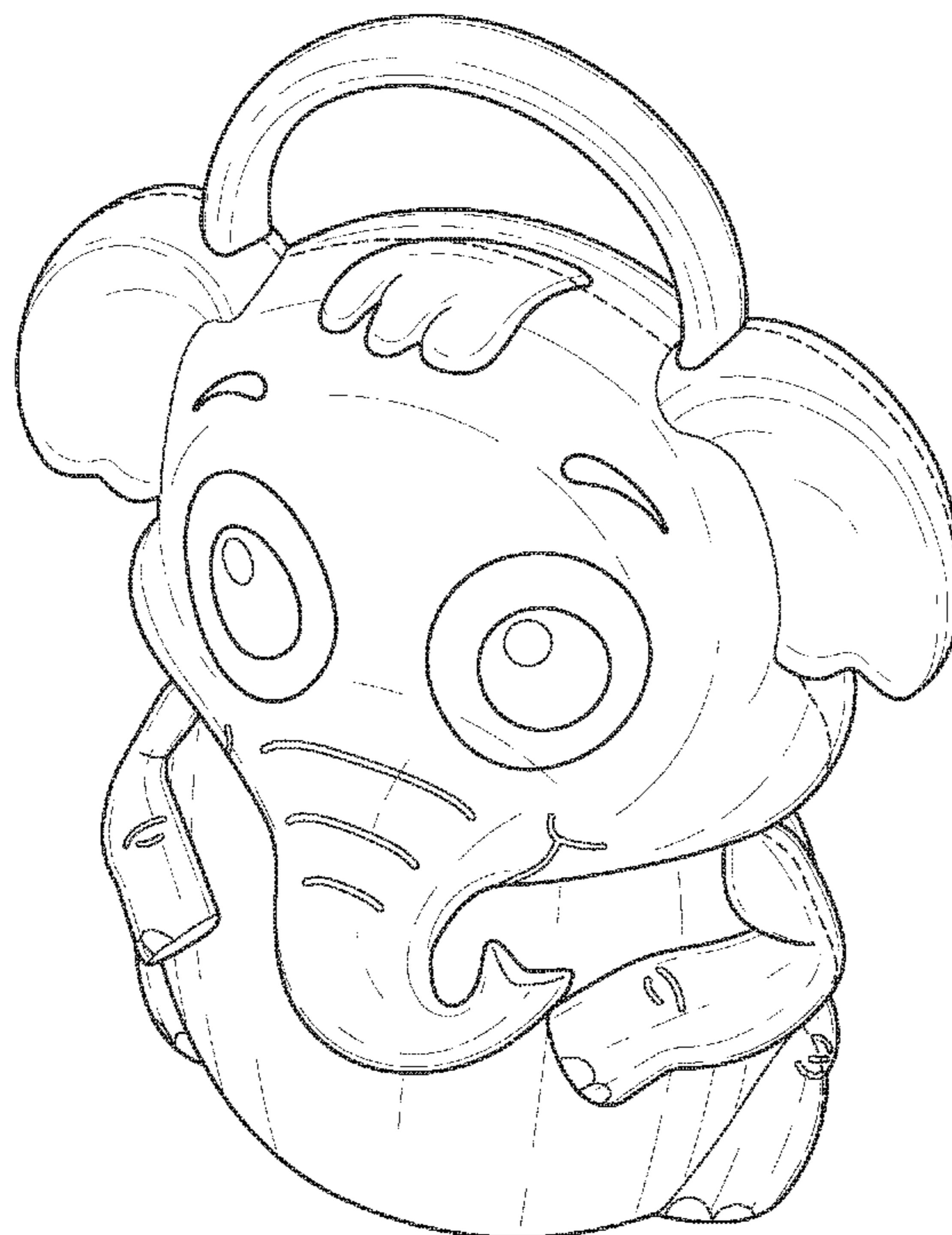

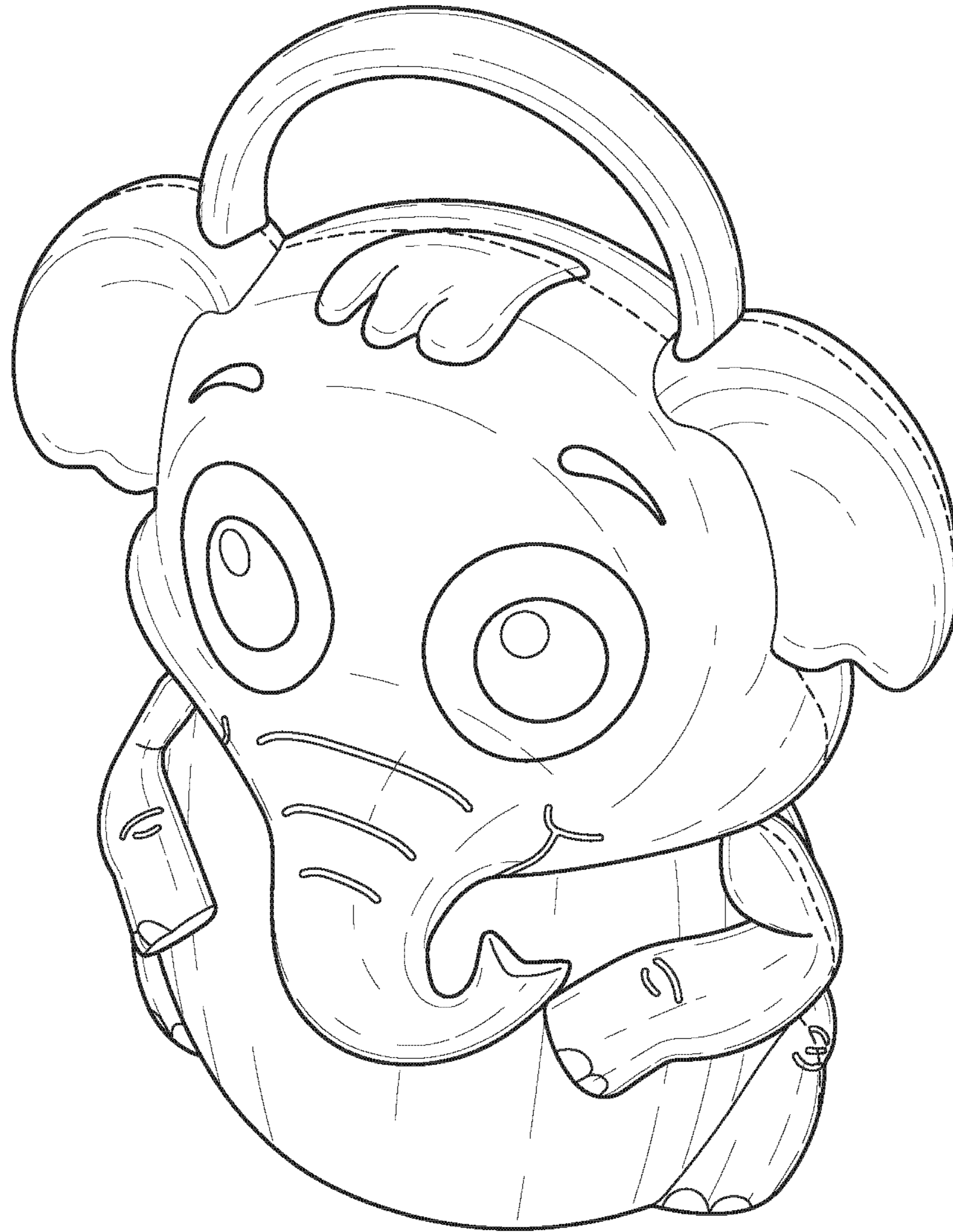

*Fig. 1*

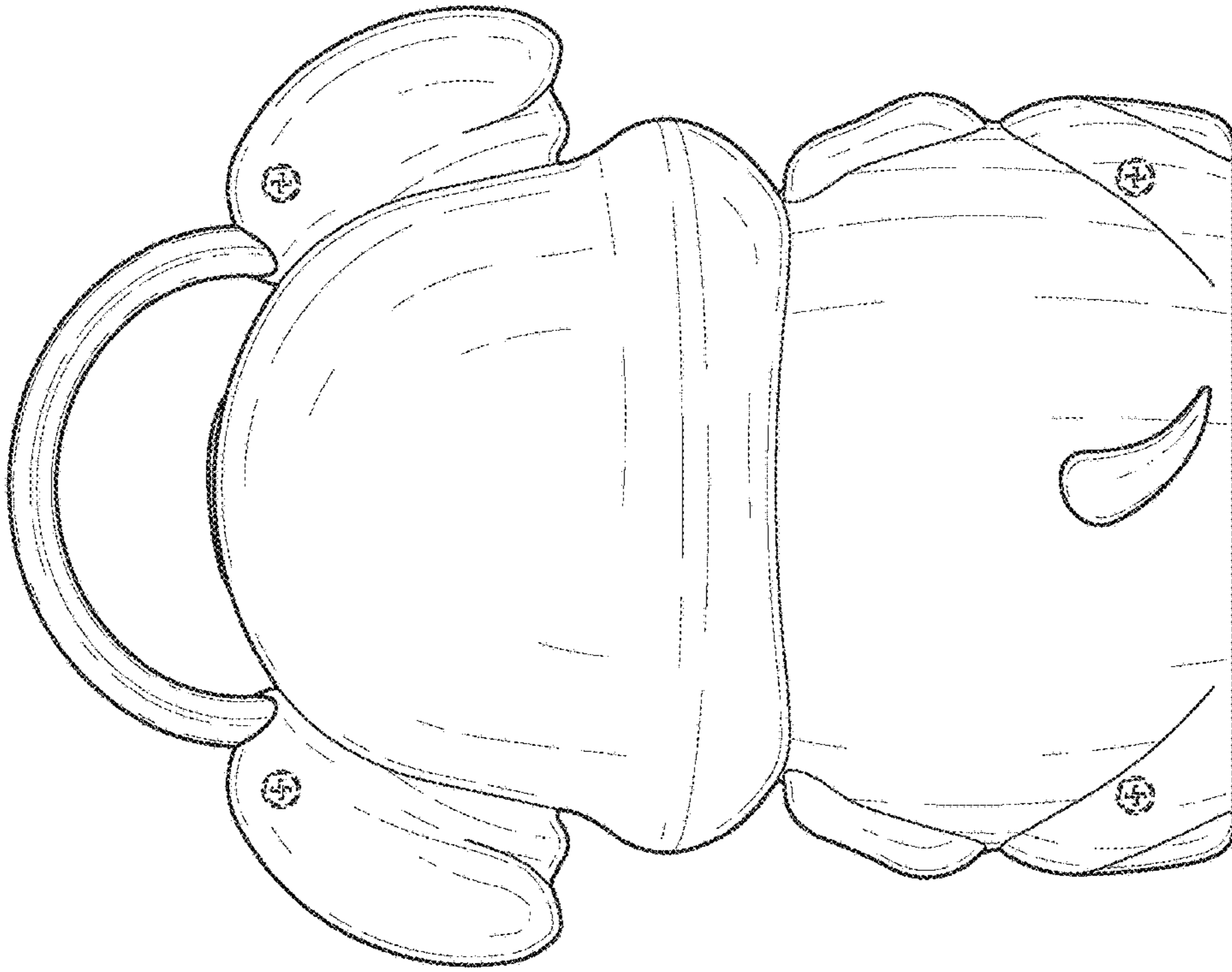
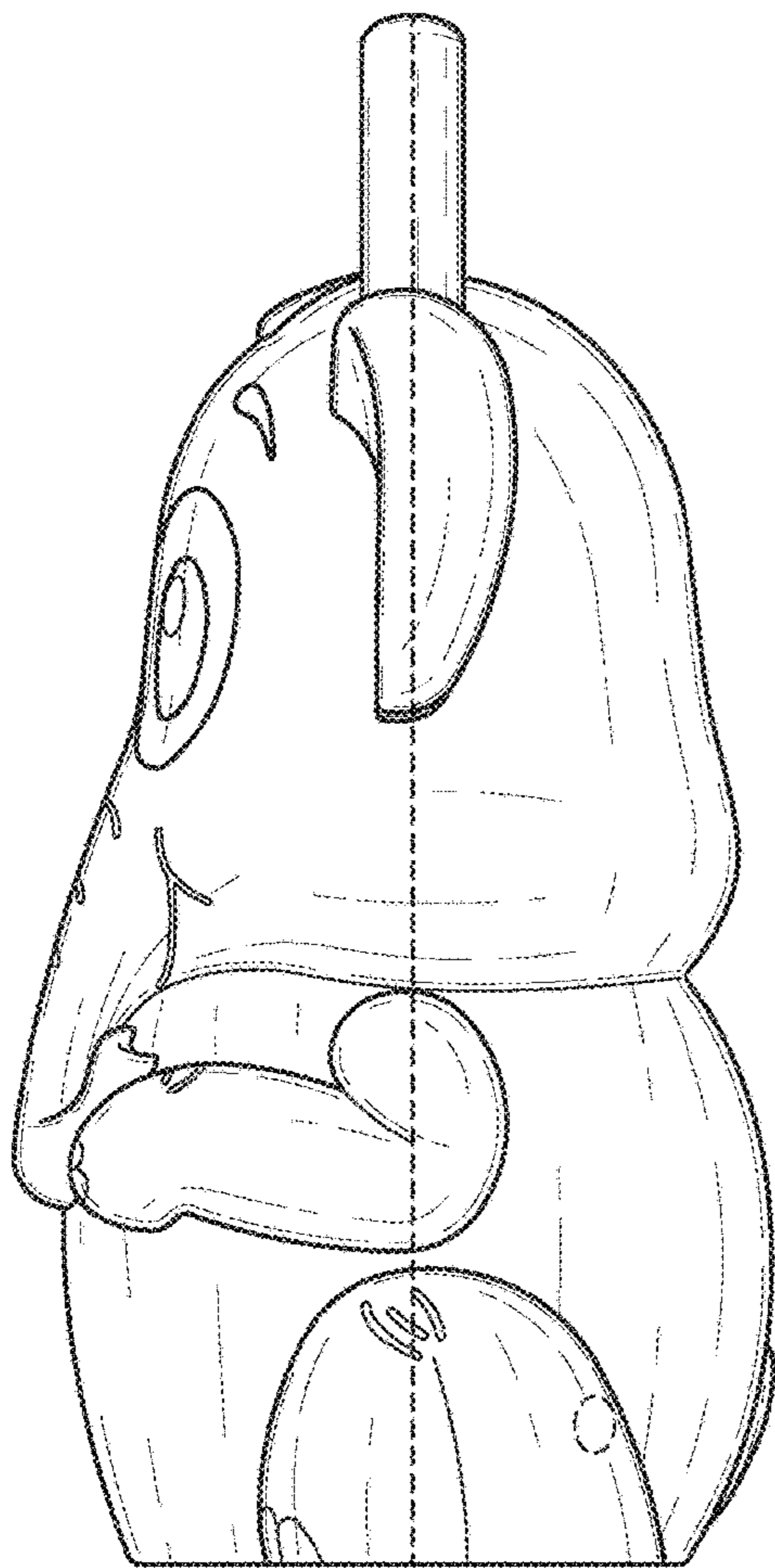

Fig. 3



Fig. 2



*Fig. 4*

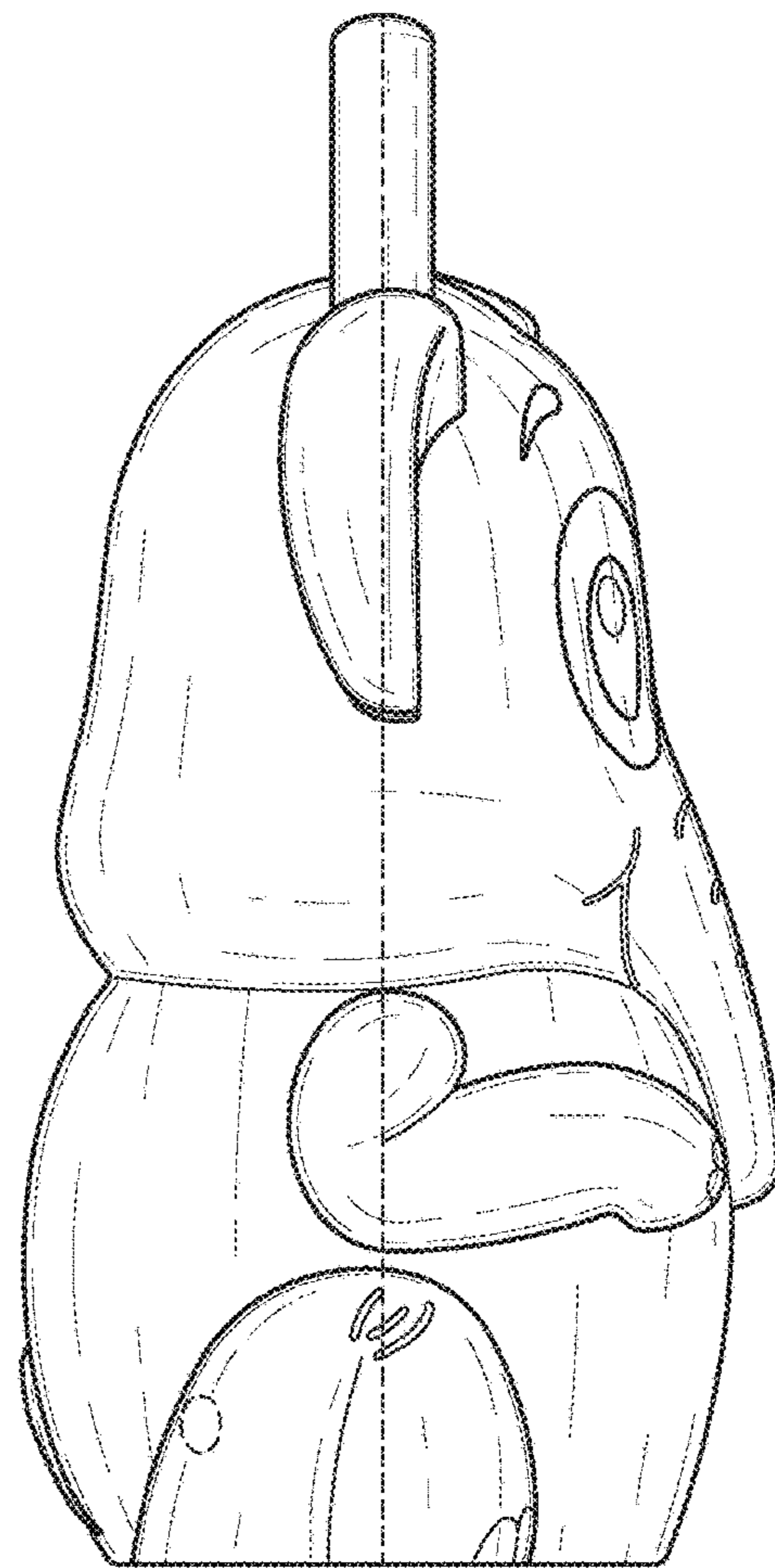

*Fig. 5*

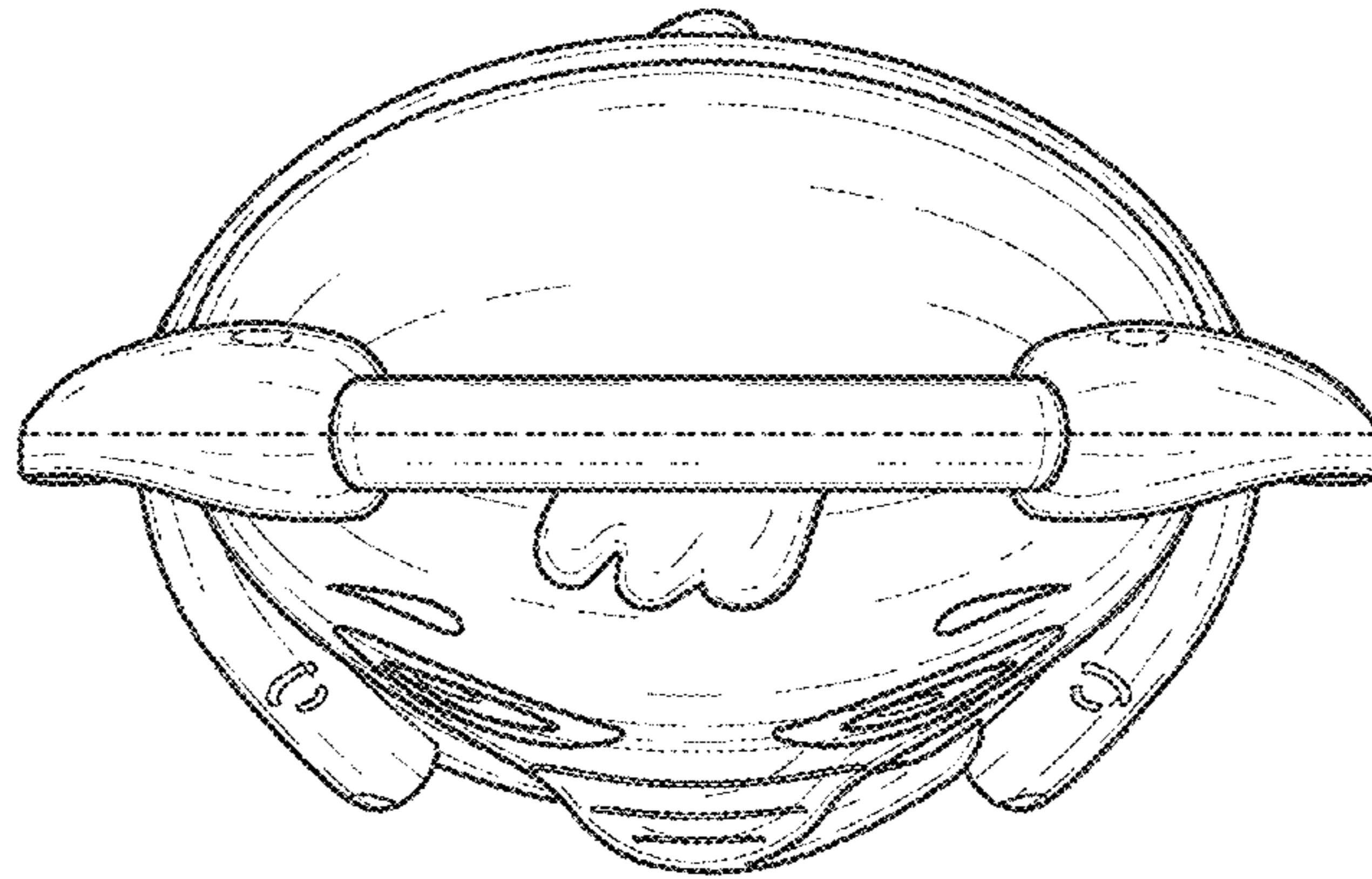

*Fig. 6*

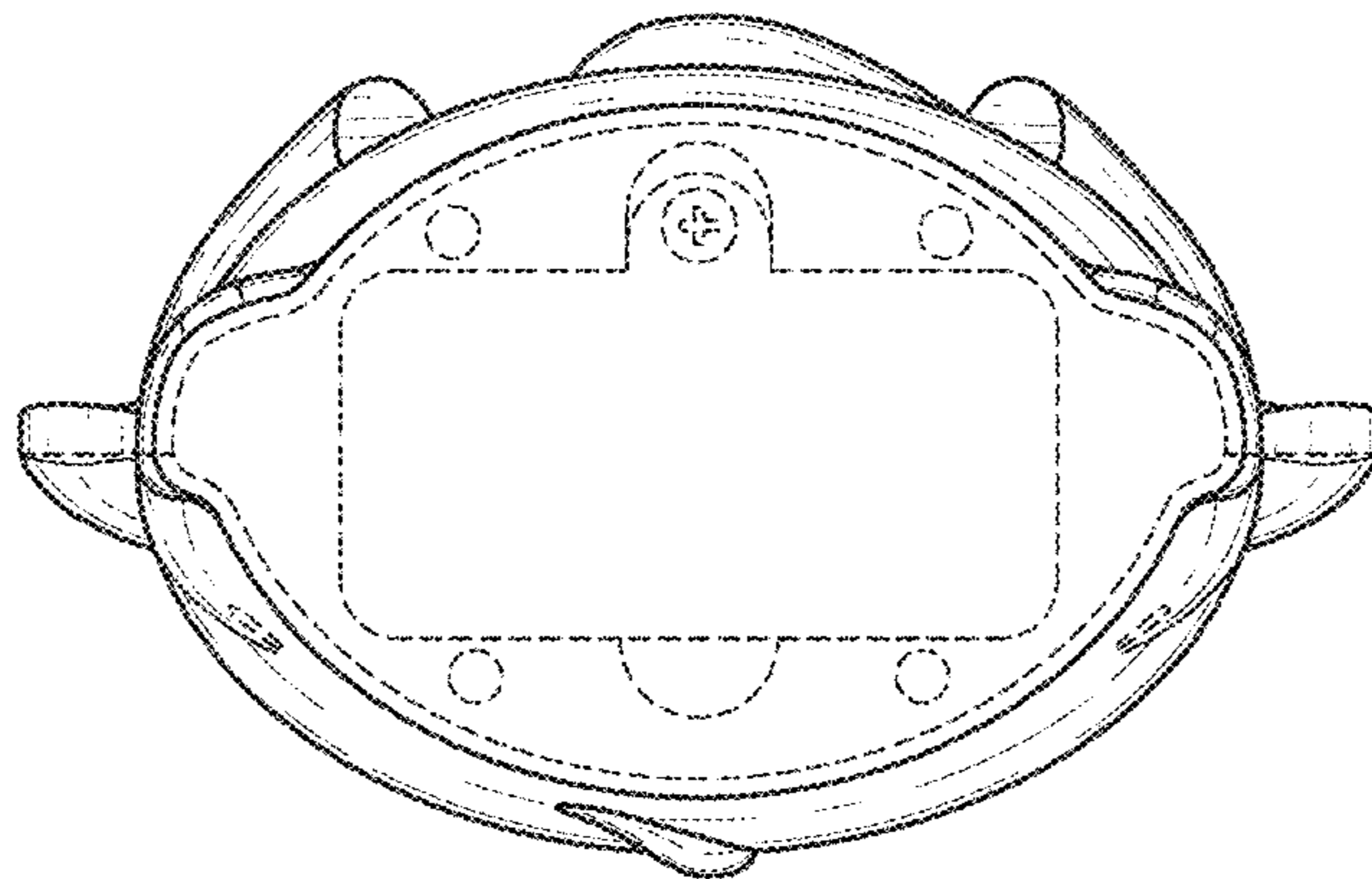

*Fig. 7*