



US00D807458S

(12) **United States Design Patent**  
**Robinson**

(10) **Patent No.:** **US D807,458 S**  
(45) **Date of Patent:** **\*\* Jan. 9, 2018**

(54) **FLOTATION DEVICE**

(71) Applicant: **The MCR Group, LLC**, Knoxville, TN (US)

(72) Inventor: **Phillip Robinson**, Knoxville, TN (US)

(73) Assignee: **The MCR Group, LLC**, Knoxville, TN (US)

(\*\*) Term: **15 Years**

(21) Appl. No.: **29/580,744**

(22) Filed: **Oct. 12, 2016**

(51) **LOC (11) Cl.** ..... **21-02**

(52) **U.S. Cl.**  
USPC ..... **D21/803**

(58) **Field of Classification Search**  
USPC ..... D21/769-770, 801, 803-805, 807-809;  
D12/5, 6, 316; D6/392, 395, 596, 601,  
D6/604, 605  
CPC ..... B63B 35/74; B63B 35/76; B63B 35/78;  
B63B 35/79; B63B 35/7906; B63B  
35/7909; B63B 35/7913; B63B 35/7916;  
B63B 35/792; B63B 35/7923; B63B  
35/7926; B63B 35/793

See application file for complete search history.

(56) **References Cited**

**U.S. PATENT DOCUMENTS**

- D152,673 S \* 2/1949 Clark ..... 441/74
- 2,975,439 A 3/1961 Bentley
- D221,697 S \* 8/1971 Nicholson ..... D12/11
- D262,476 S \* 12/1981 Churchill ..... D21/770
- D265,116 S \* 6/1982 Churchill ..... 441/74
- 4,619,619 A \* 10/1986 Muse, Jr. .... B63B 35/7906  
441/65
- D299,846 S \* 2/1989 Shanelec ..... D21/769
- D299,847 S \* 2/1989 Shanelec ..... D21/769
- D305,144 S \* 12/1989 Shanelec ..... D12/310
- D305,145 S \* 12/1989 Shanelec ..... D12/310
- D313,452 S 1/1991 Overton
- D342,114 S \* 12/1993 Healy ..... D21/769

- D345,323 S \* 3/1994 Stimpson ..... D11/157
  - D349,935 S \* 8/1994 Simonson ..... D21/769
  - D377,821 S 2/1997 Kuan
- (Continued)

**FOREIGN PATENT DOCUMENTS**

WO 9209334 6/1992

**OTHER PUBLICATIONS**

[https://www.amazon.com/s/ref=nb\\_sb\\_ss\\_c\\_1\\_15?url=search-alias%3Daps&field-keywords=swimming+kickboard&prefix=swimming+kickbo%2Caps%2C116&crd=1EF4NE8RBLNY5](https://www.amazon.com/s/ref=nb_sb_ss_c_1_15?url=search-alias%3Daps&field-keywords=swimming+kickboard&prefix=swimming+kickbo%2Caps%2C116&crd=1EF4NE8RBLNY5)—Retrieved Aug. 15, 2017.\*

(Continued)

*Primary Examiner* — Manpreet Matharu

*Assistant Examiner* — Mojtaba Tehrani

(74) *Attorney, Agent, or Firm* — Calfee, Halter & Griswold LLP

(57) **CLAIM**

I claim the ornamental design for a flotation device, as shown and described.

**DESCRIPTION**

FIG. 1 is a top perspective view of a flotation device of the new design;

FIG. 2 is a bottom perspective view thereof;

FIG. 3 is a top view thereof;

FIG. 4 is a bottom view thereof;

FIG. 5 is a left side view thereof;

FIG. 6 is a right side view thereof;

FIG. 7 is a rear view thereof; and,

FIG. 8 is a front view thereof.

The evenly broken line (dash-dash) in the figure drawings represents unclaimed environment only and forms no part of the claimed design. The dash-dot broken line represents the boundary of the claim and forms no part of the claimed design.

**1 Claim, 6 Drawing Sheets**

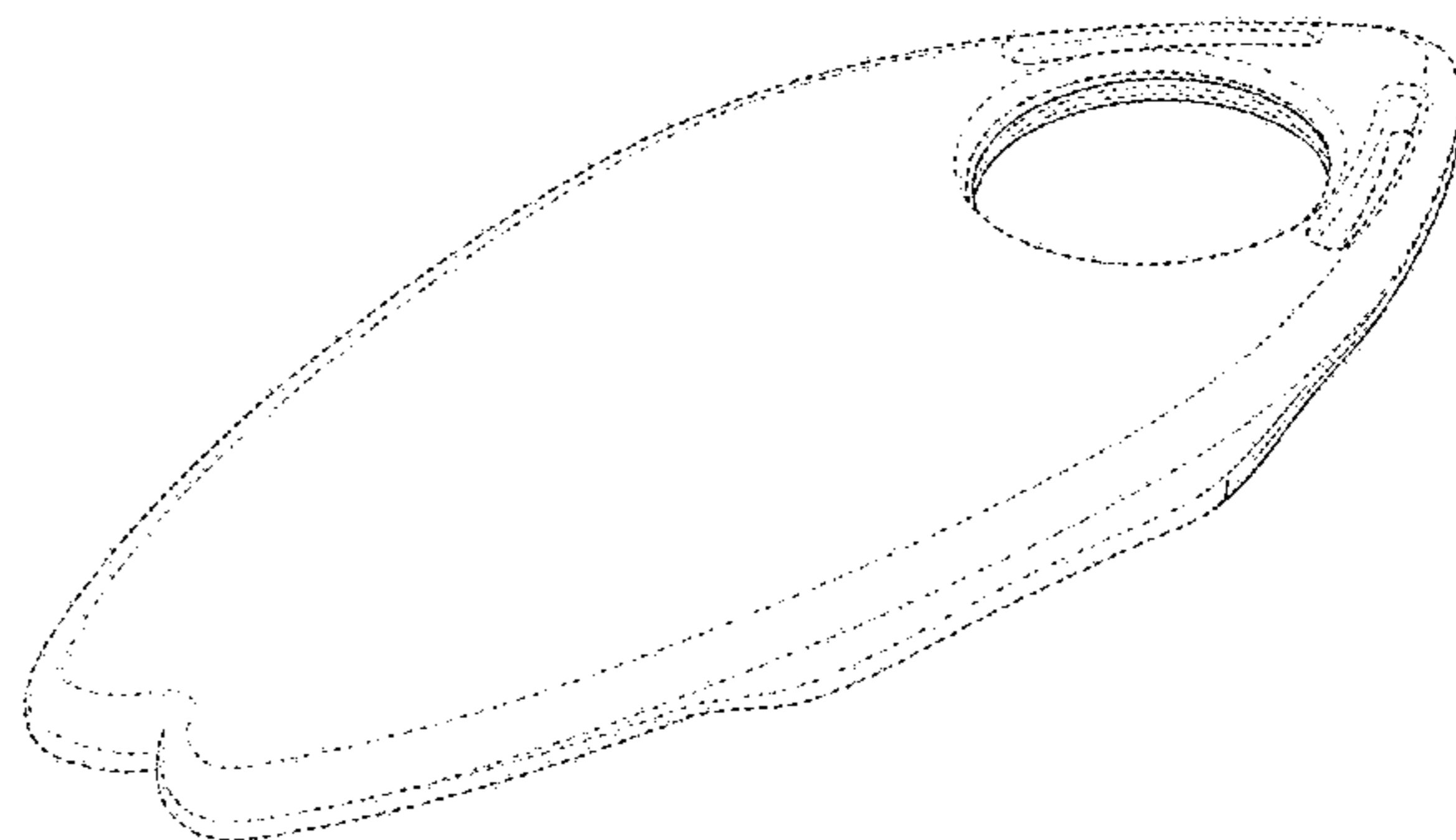
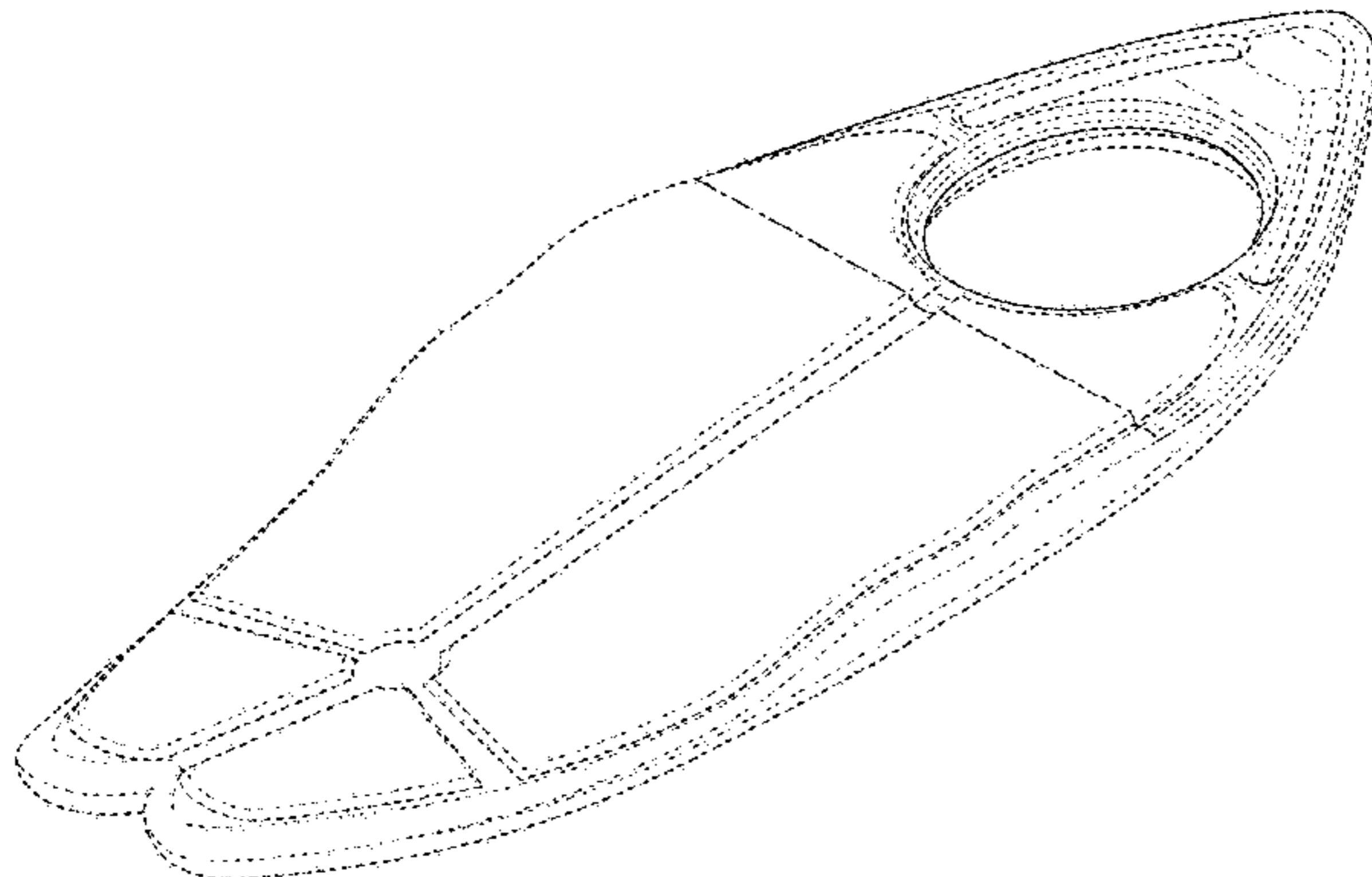

(56)

References Cited

U.S. PATENT DOCUMENTS

D378,692 S \* 4/1997 Lincoln ..... B63B 35/7906  
D21/769  
5,679,040 A 10/1997 Bianchi-Holm  
D392,710 S \* 3/1998 del Paso ..... D21/769  
D394,095 S 5/1998 Kuan  
D414,235 S 9/1999 Peterson  
6,000,978 A 12/1999 Donahue  
D428,459 S \* 7/2000 Broz ..... D21/769  
D432,612 S \* 10/2000 Bowlds, Jr. .... D21/769  
6,129,081 A 10/2000 Wu  
D455,186 S \* 4/2002 Koester ..... D21/769  
6,428,376 B1 \* 8/2002 Reeder ..... B63B 35/7926  
441/65  
6,659,825 B2 12/2003 Foss  
D503,206 S \* 3/2005 Debold ..... D21/769  
D528,179 S \* 9/2006 Stagnaro ..... D21/769  
D582,500 S \* 12/2008 Hoffman ..... D21/803  
D606,276 S \* 12/2009 Acunzo ..... D1/105  
D606,608 S \* 12/2009 del Pino Bermejo ..... D21/769  
D606,609 S \* 12/2009 del Pino Bermejo ..... D21/769  
D607,074 S \* 12/2009 Chables Sandoval ..... D21/769  
D607,520 S \* 1/2010 del Pino Bermejo ..... D21/769  
D607,521 S \* 1/2010 Chables Sandoval ..... D21/769  
D607,522 S \* 1/2010 del Pino Bermejo ..... D21/769  
D607,523 S \* 1/2010 Chables Sandoval ..... D21/769  
8,011,364 B2 9/2011 Johnson  
8,096,298 B2 1/2012 Shieh  
D665,866 S 8/2012 Scott  
D673,233 S \* 12/2012 Baggett ..... D21/769  
D713,917 S \* 9/2014 Brodhead ..... D21/769

D718,826 S \* 12/2014 Barron ..... B63B 35/7906  
D21/769  
2006/0116039 A1 6/2006 Pole, III  
2006/0252318 A1 11/2006 Krantz  
2008/0135045 A1 6/2008 Johnson  
2009/0078186 A1 3/2009 Rista  
2010/0229858 A1 9/2010 Wheelwright  
2012/0156951 A1 6/2012 Segev  
2013/0280974 A1 10/2013 Mulvihill  
2017/0088240 A9\* 3/2017 Watts ..... B63B 35/7906

OTHER PUBLICATIONS

Website printout, Kapitool Reef Snorkel; <http://www.tomzap.com/kapitol.html>; 2013; 2 pages.  
Website printout, Blue Reef Snorkeling Vest; <http://leisurepro.com/p-blrsv/blue-reef-snorkeling-vest>; copyright 1992-2015; 8 pages.  
Website printout. SUP Boards From YOLO Board—One of the Nation's Leading SUP Board Provider; SUPBOARDS; <http://yoloboard.com/shop/sup-board.php?gclid=CPC0q5Sa7MQCFU1o7AodnScAzg>; copyright 2014; 3 pages.  
Website printout, SUP Paddle Boards—Leisure Pro Diver Emporium; <http://www.leisurepro.com/Catalog.aspx?op=gcsSearch&Term=sup+paddle+boards>; copyright 1992-2015; 8 pages.  
Website printout, Scuba BCD, Scuba Diving BC, Scuba BC, Buoyancy Compensator; <http://www.scuba.com/scuba-gear/Buoyancy-Compensators.html>; copyright 2000-2015; 3 pages.  
International Search Report and Written Opinion from International Application No. PCT/US2015/016286, dated May 20, 2015.

\* cited by examiner

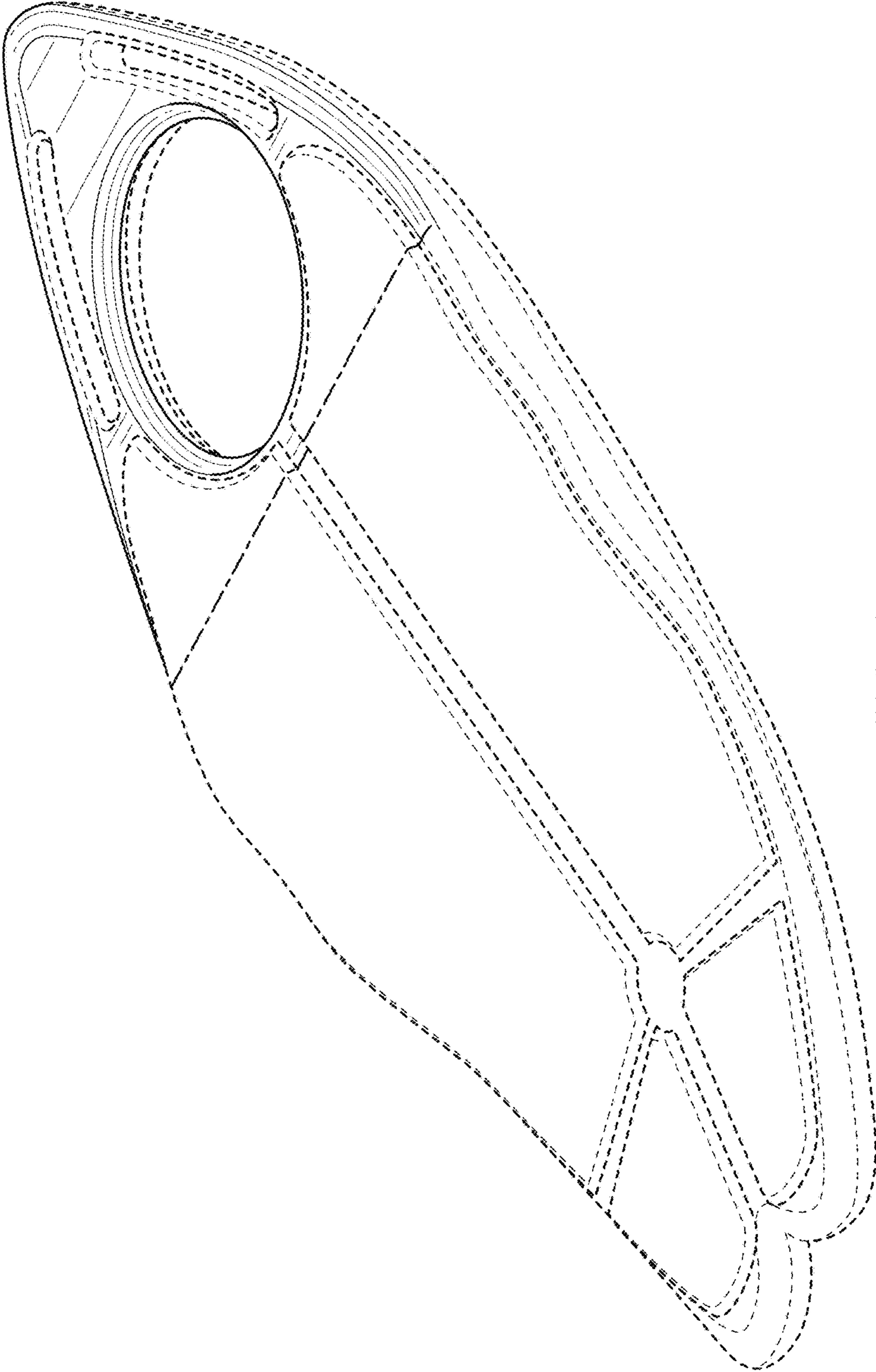

FIG. 1

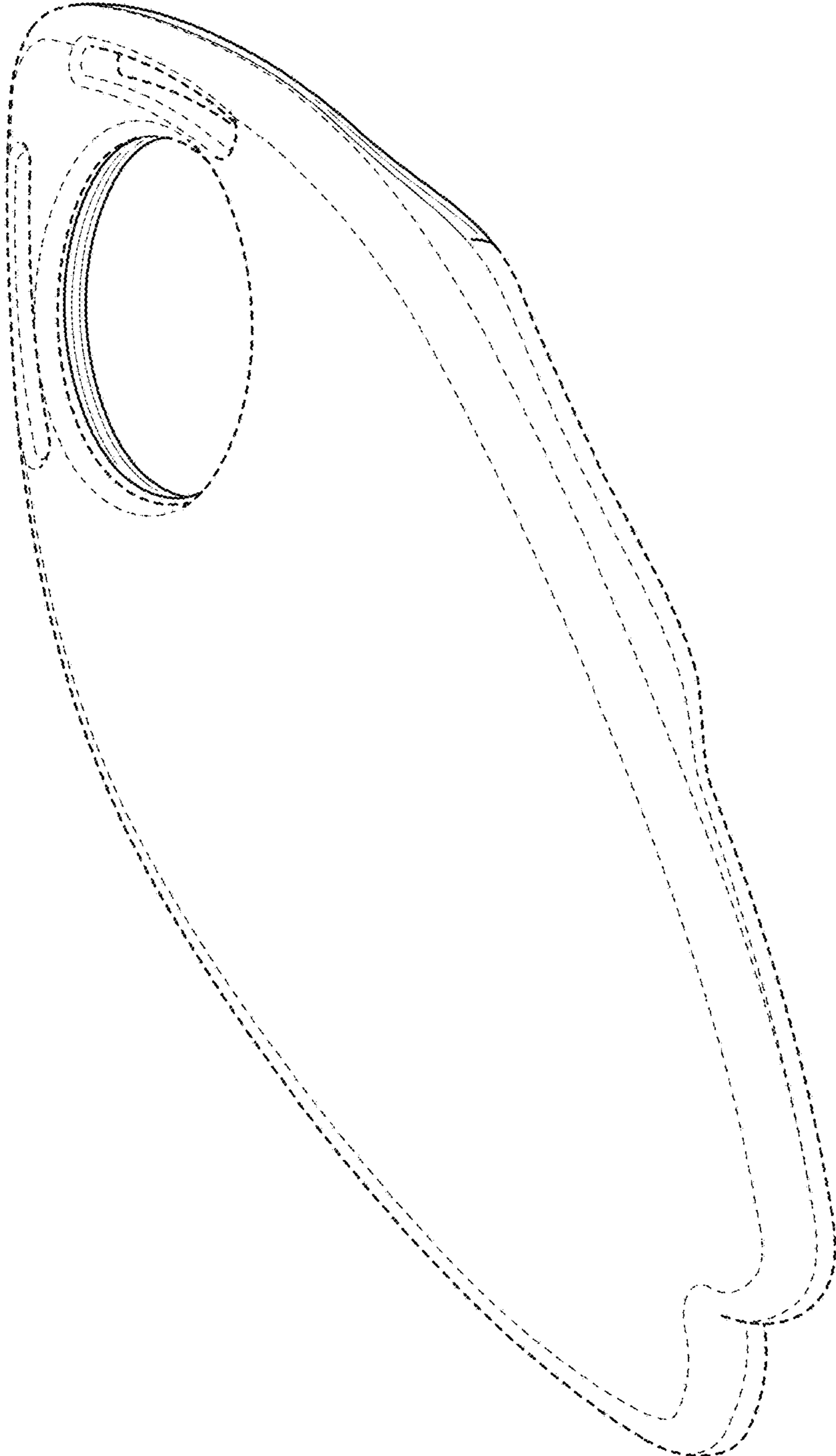

FIG. 2

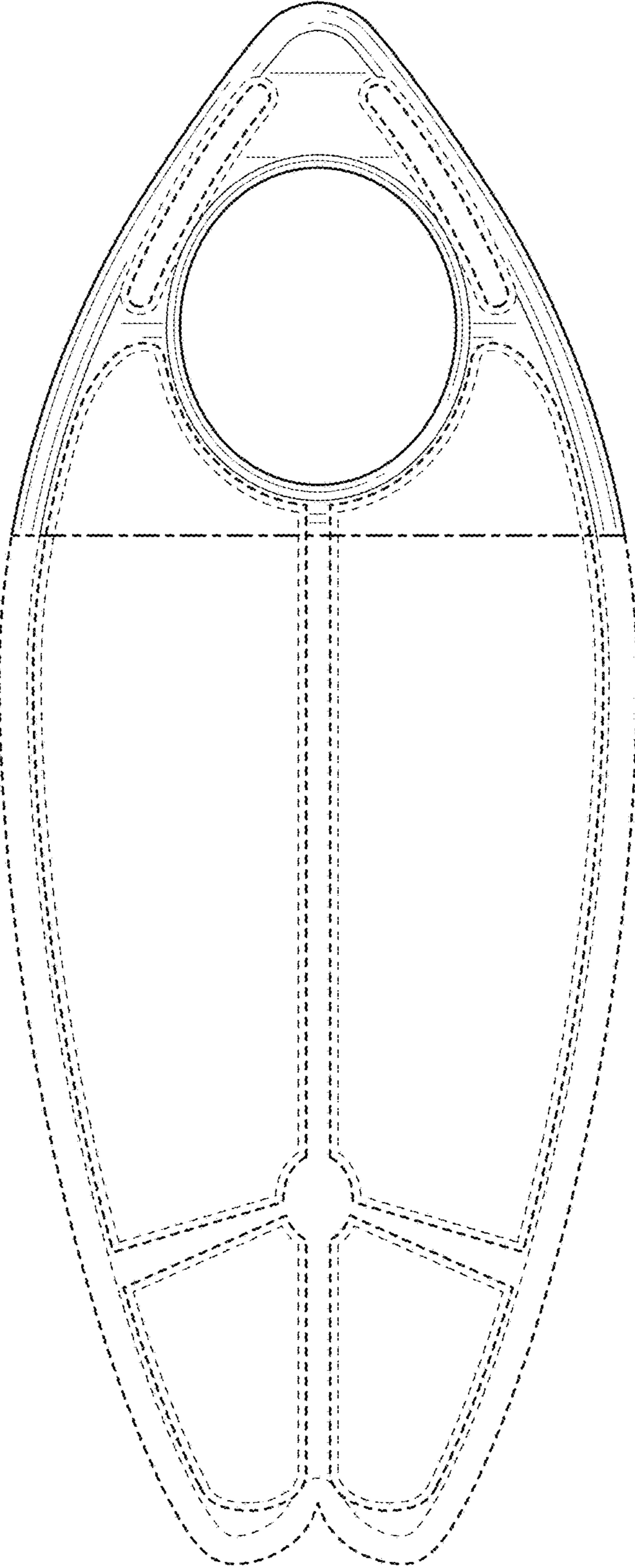

FIG. 3

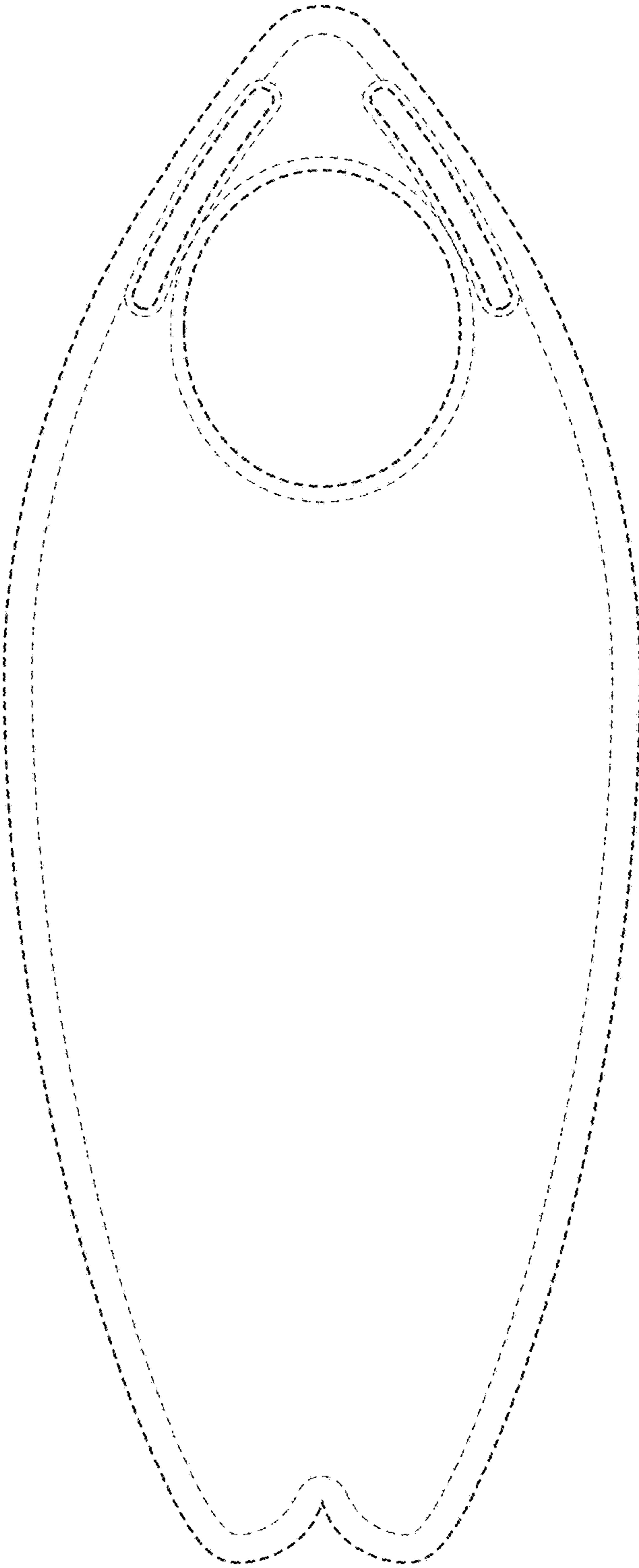

FIG. 4

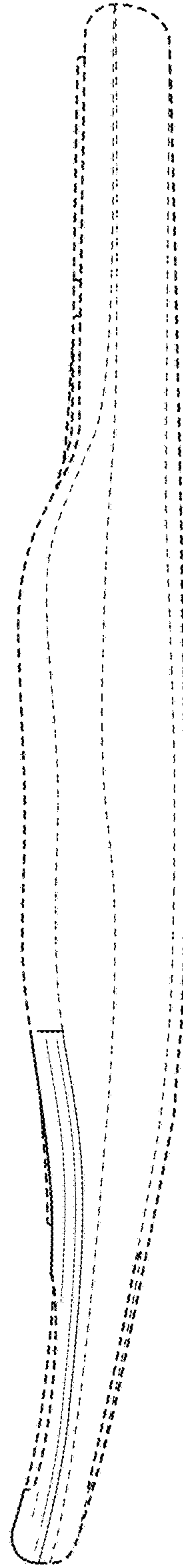

FIG. 5

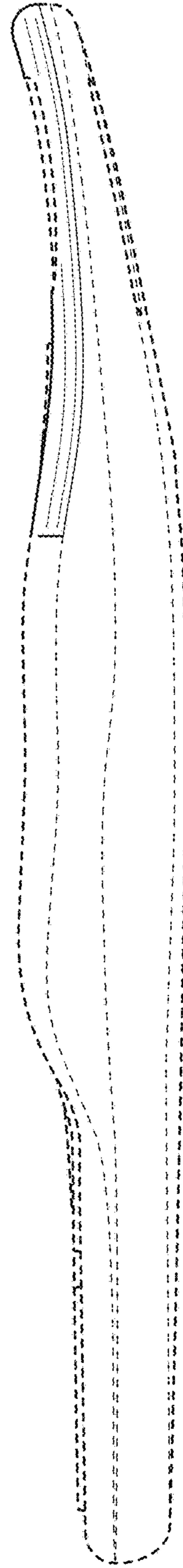

FIG. 6

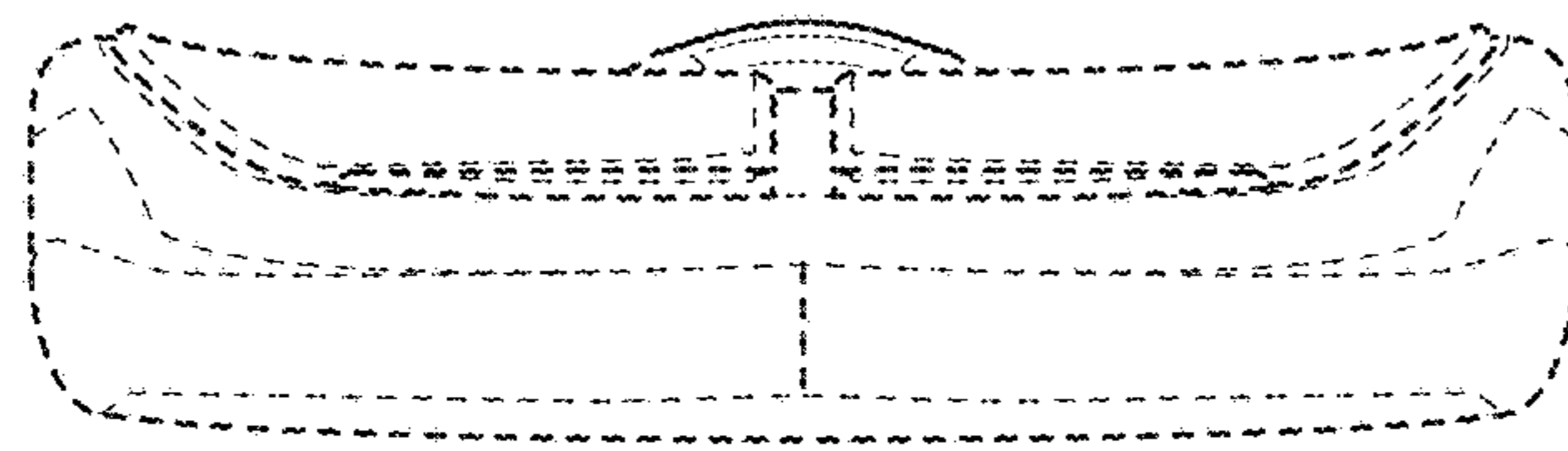

FIG. 7

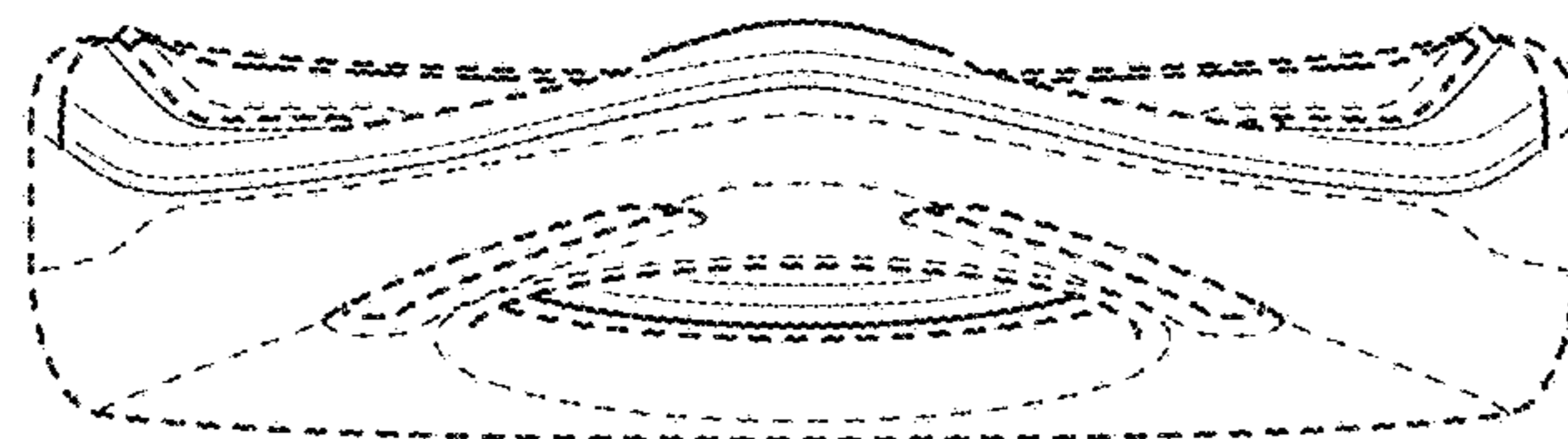

FIG. 8