



US00D807406S

(12) **United States Design Patent**
Loew et al.

(10) **Patent No.:** **US D807,406 S**
(45) **Date of Patent:** **** Jan. 9, 2018**

(54) **FRONT PART OF A TANDEM ROLLER**

(71) Applicant: **BOMAG GmbH**, Boppard (DE)

(72) Inventors: **Roland Loew**, Klein-Winterheim (DE);
Christian Berg, Völkenroth (DE);
Thomas Klein, Wehr (DE); **Tobias Schönberg**, Oberelbert (DE)

(73) Assignee: **BOMAG GmbH**, Boppard (DE)

(**) Term: **15 Years**

(21) Appl. No.: **29/587,348**

(22) Filed: **Dec. 13, 2016**

(30) **Foreign Application Priority Data**

Jun. 13, 2016 (EM) 003188713-0003

(51) **LOC (11) Cl.** **15-03**

(52) **U.S. Cl.**
USPC **D15/31**

(58) **Field of Classification Search**
USPC D15/10, 11, 13-17, 22-26, 28, 31;
D12/173; 56/13.3, 13.4, 15.8, 15.9,
56/320.1; 180/89.1, 89.12, 900, 69.2,
180/68.1, 69.1
CPC B62D 25/10; B62D 25/00; B62D
49/00-49/085; B60R 19/52; B60R 21/38;
B60K 13/02; B60K 11/08; B60K 11/04;
F01P 11/10; F01P 5/06; F01P 2001/005;
B60Y 2200/221

See application file for complete search history.

(56) **References Cited**

U.S. PATENT DOCUMENTS

D578,274 S * 10/2008 Tokach D15/31
D611,505 S * 3/2010 Loew D15/20
D611,506 S * 3/2010 Loew D15/20

D624,567 S * 9/2010 Kelley D15/30
D629,818 S * 12/2010 Rummer D15/31
D632,313 S * 2/2011 Kelley D15/30
D670,746 S * 11/2012 Ewringmann D15/31
D676,466 S * 2/2013 Ewringmann D15/20
D708,233 S * 7/2014 Furuki D15/28
D715,333 S * 10/2014 Jacobsthal D15/31
D724,109 S * 3/2015 Haro D15/20
D751,611 S * 3/2016 Smith D15/31
D757,826 S * 5/2016 Hartz D15/31
D762,740 S * 8/2016 Okuyama D15/28
D766,339 S * 9/2016 Hanke D15/31
D784,426 S * 4/2017 Okuyama D15/31
D786,945 S * 5/2017 Smith D15/31

(Continued)

Primary Examiner — Mark Goodwin

(74) *Attorney, Agent, or Firm* — Wood Herron & Evans
LLP

(57) **CLAIM**

The ornamental design for a front part of a tandem roller, as shown and described.

DESCRIPTION

FIG. 1 is a front right perspective view of a front part of a tandem roller showing our new design;
FIG. 2 is a front left perspective view of the front part of a tandem roller shown in FIG. 1;
FIG. 3 is a right side elevation view of the front part of a tandem roller shown in FIG. 1;
FIG. 4 is a left side elevation view of the front part of a tandem roller shown in FIG. 1;
FIG. 5 is a front elevation view of the front part of a tandem roller shown in FIG. 1; and,
FIG. 6 is a top plan view of the front part of a tandem roller shown in FIG. 1.

The broken dash lines denote unclaimed portions of the invention. Neither the broken dash line portions nor the broken dash lines themselves forms any part of the claimed invention.

1 Claim, 6 Drawing Sheets

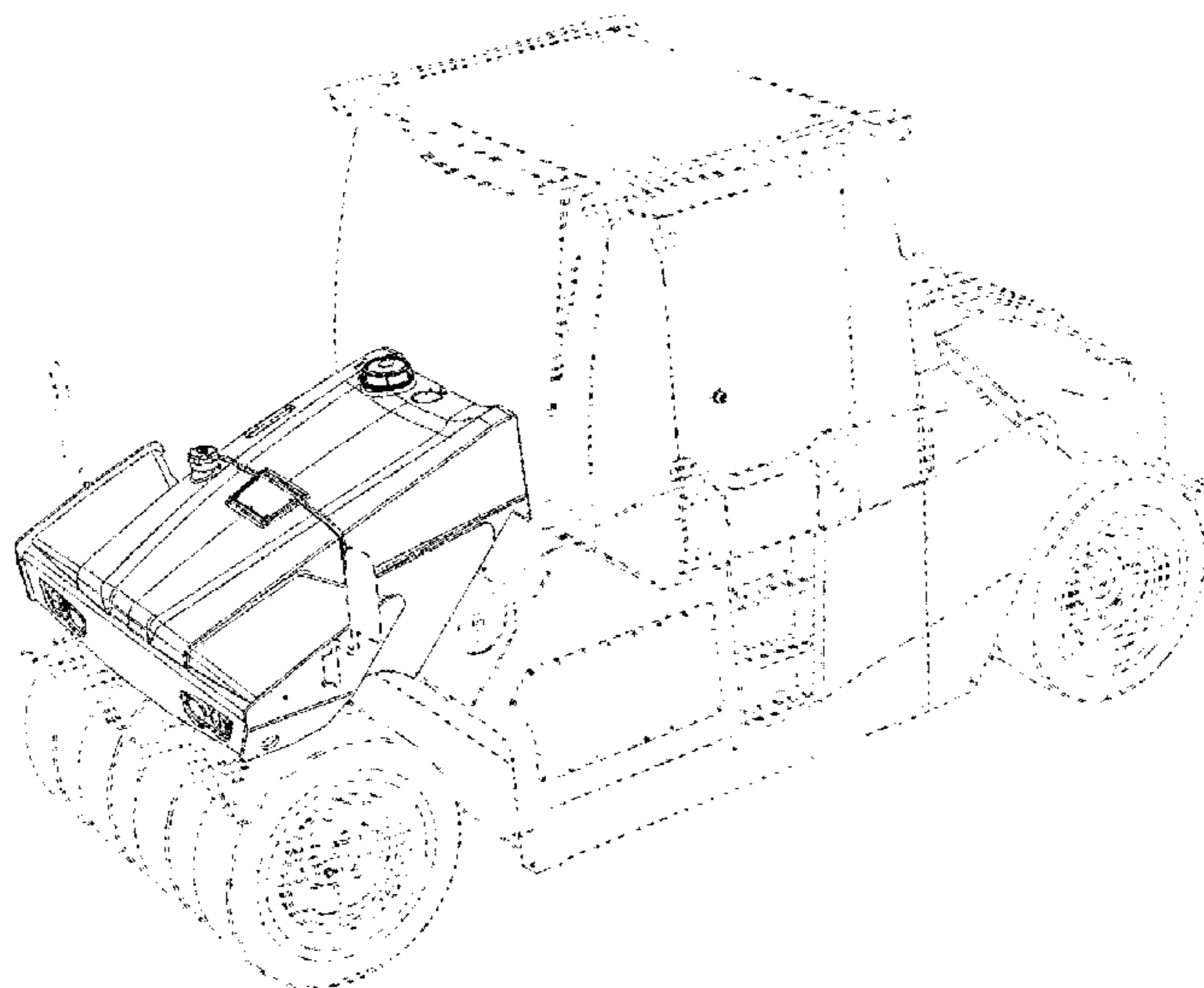

(56)

References Cited

U.S. PATENT DOCUMENTS

D795,308 S * 8/2017 Sauvaget D15/31
D795,309 S * 8/2017 Sauvaget D15/31

* cited by examiner

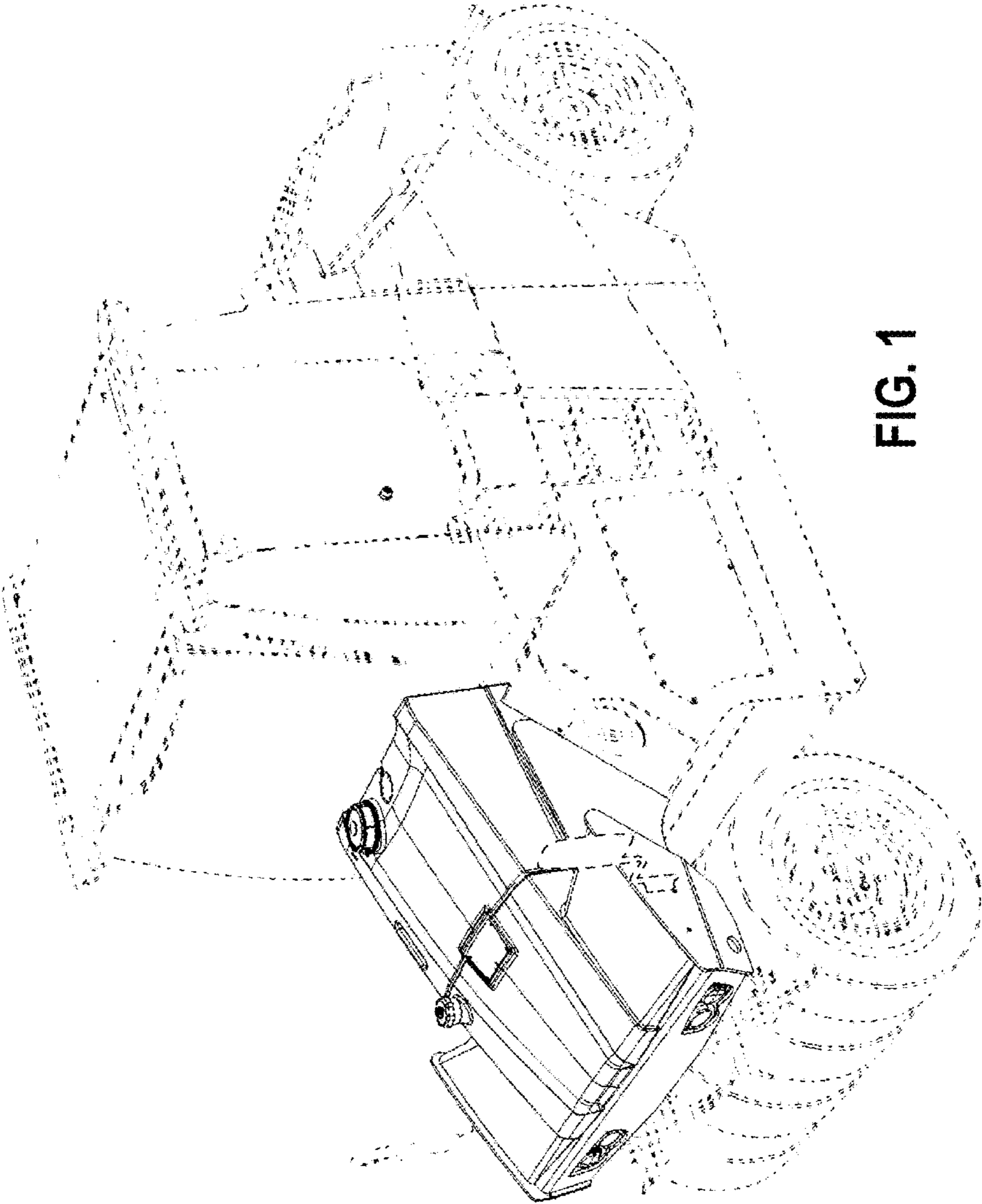

FIG. 1

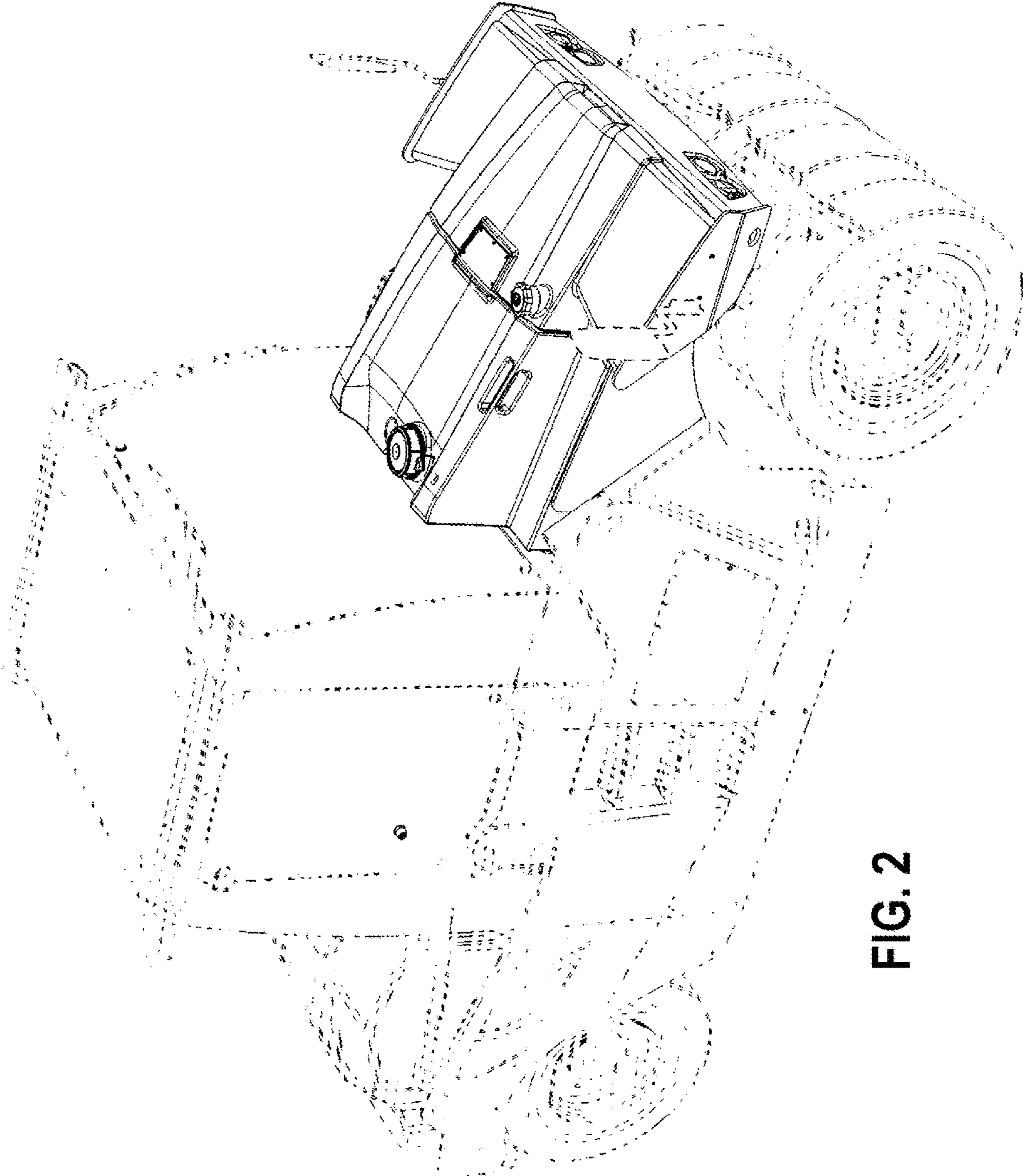

FIG. 2

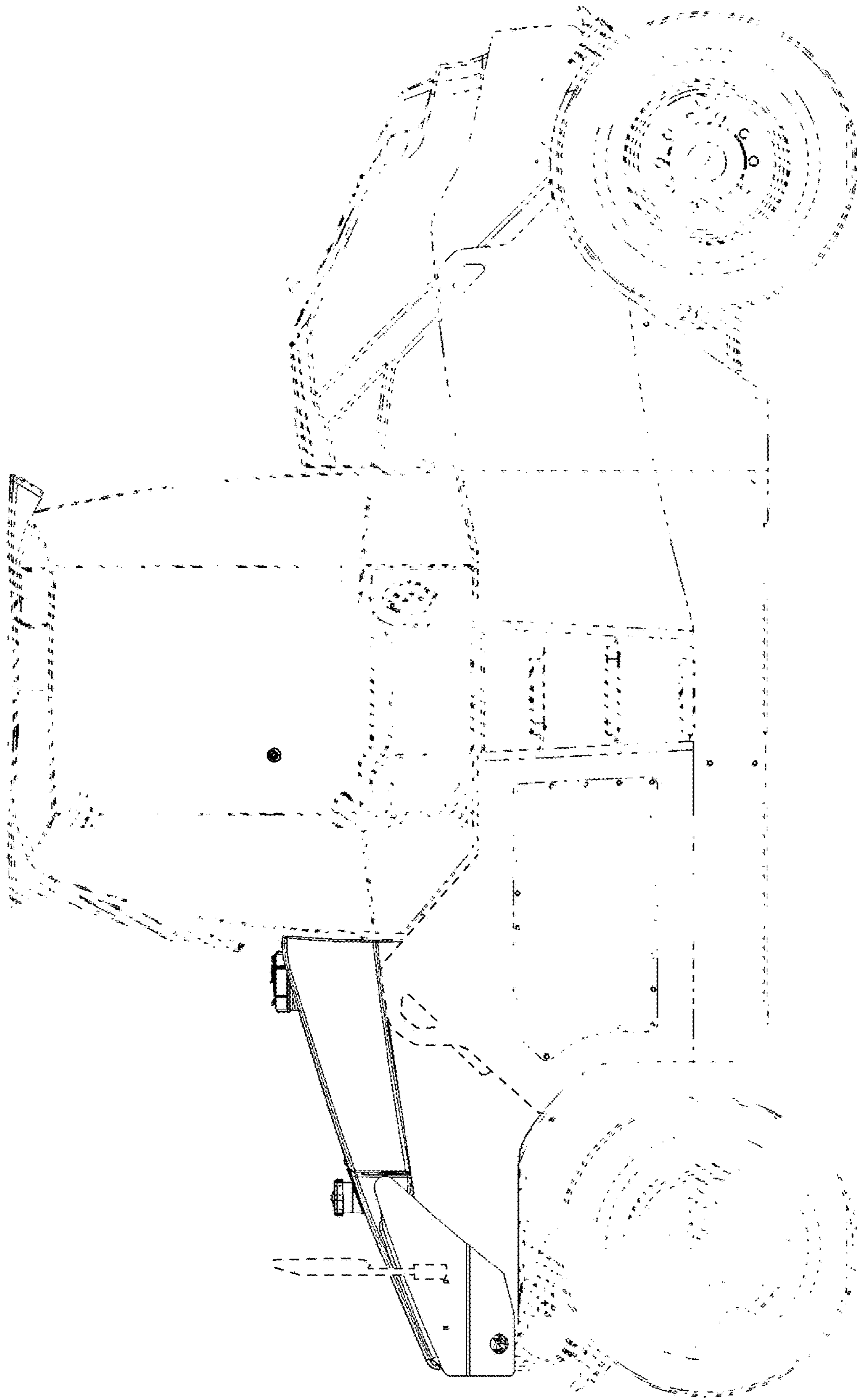

FIG. 3

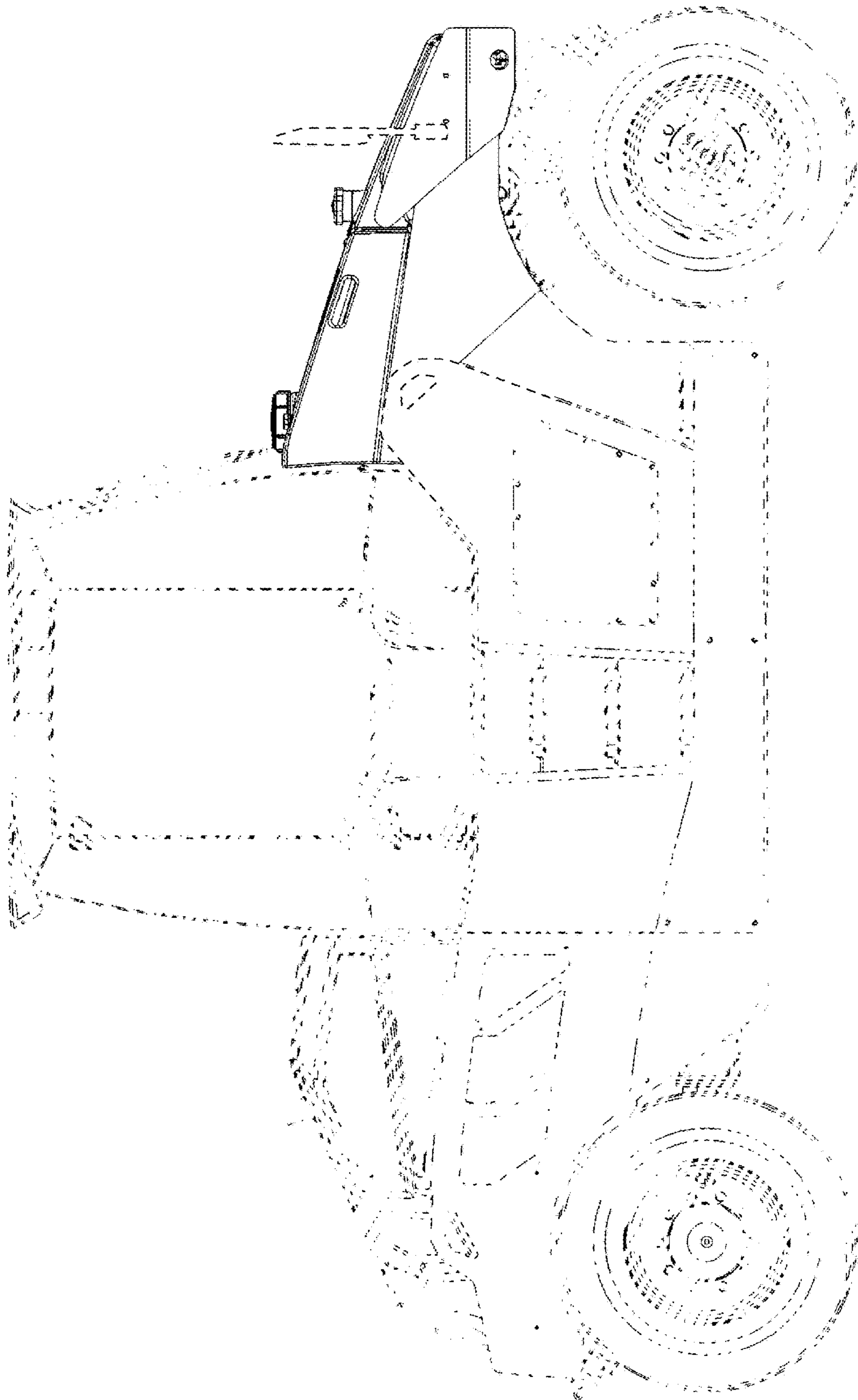

FIG. 4

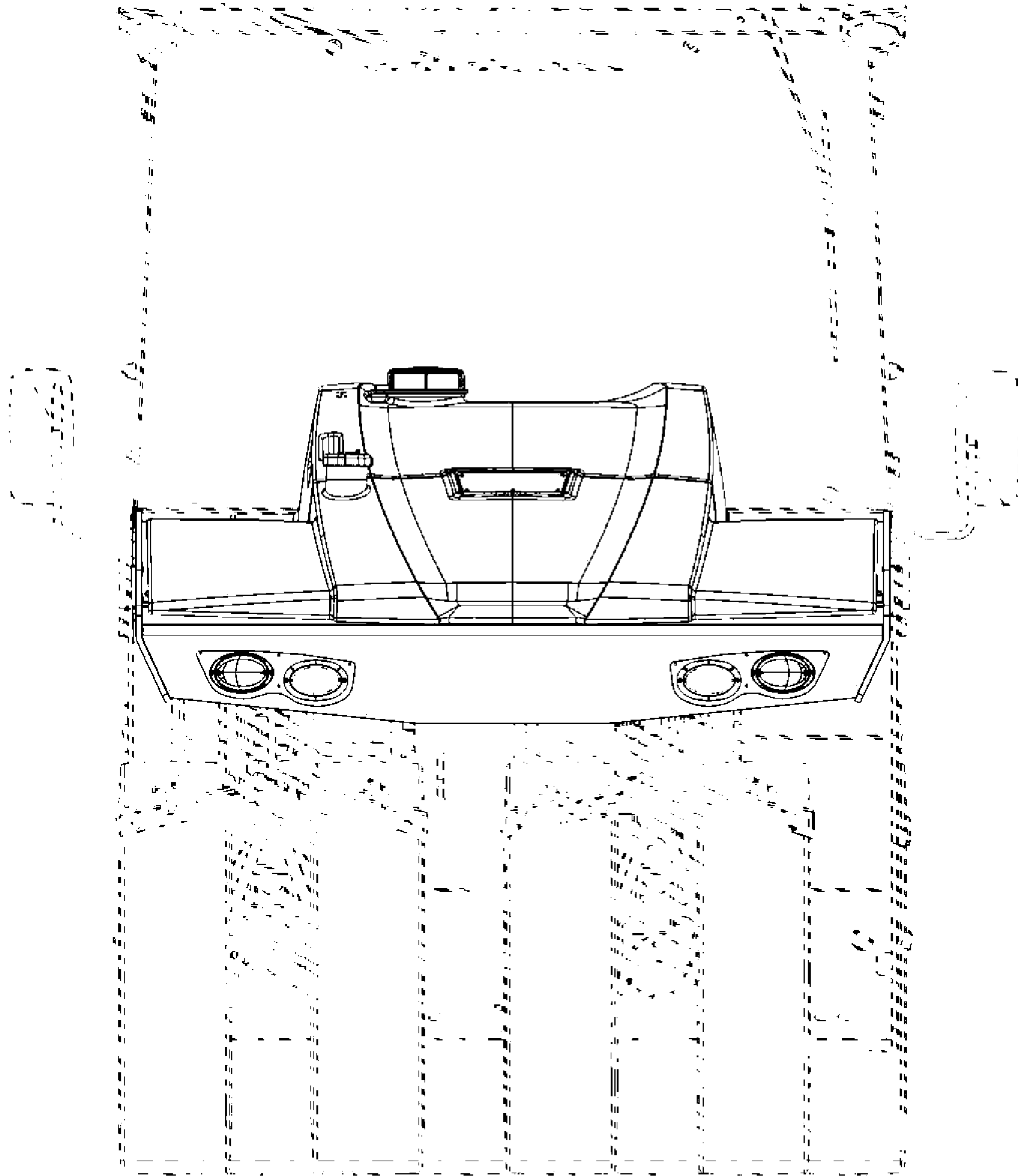

FIG. 5

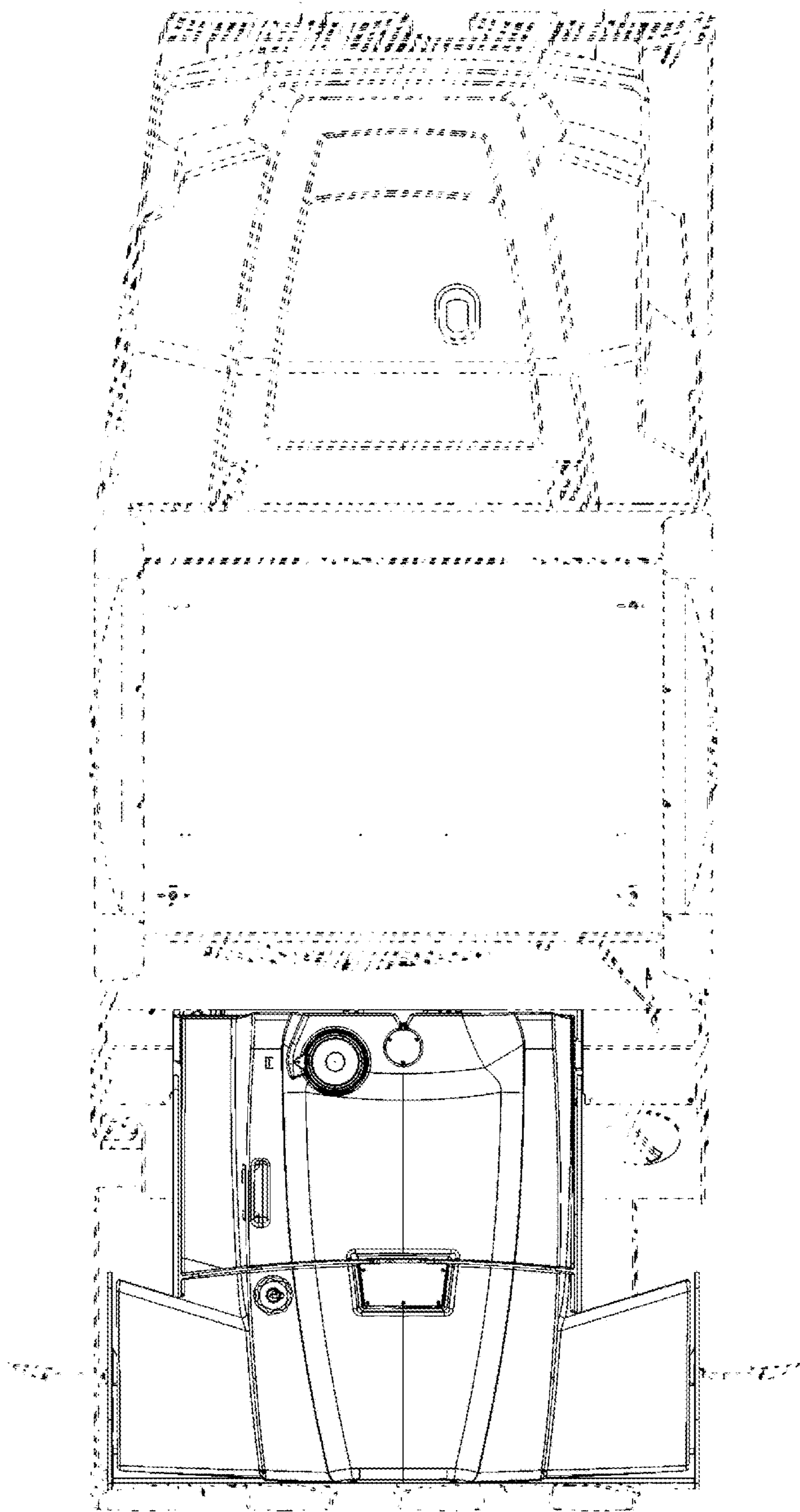

FIG. 6