



US00D807403S

(12) **United States Design Patent**  
**Lam**

(10) **Patent No.:** **US D807,403 S**  
(45) **Date of Patent:** **\*\* Jan. 9, 2018**

(54) **HAND-OPERABLE VACUUM PUMP**

(71) Applicant: **California Exotic Novelties LLC**,  
Ontario, CA (US)

(72) Inventor: **Kevin Lam**, Hong Kong (HK)

(73) Assignee: **California Exotic Novelties LLC**,  
Ontario, CA (US)

(\*\*) Term: **15 Years**

(21) Appl. No.: **29/562,059**

(22) Filed: **Apr. 22, 2016**

(51) **LOC (11) Cl.** ..... **15-02**

(52) **U.S. Cl.**  
USPC ..... **D15/7; D24/215**

(58) **Field of Classification Search**  
USPC ..... D15/7-9; D23/231, 232, 225; 417/60,  
417/235, 265, 321, 355, 358, 363, 359,  
417/410.1, 415-416, 405, 900, 269, 539;  
60/408, 412; 184/26-37; 415/140-147;  
123/495, 509; 137/565.34; D24/215  
CPC ..... F02M 37/04; F02M 37/14; F04B 53/92;  
F04B 1/005  
See application file for complete search history.

(56) **References Cited**

**U.S. PATENT DOCUMENTS**

- 4,856,498 A \* 8/1989 Osbon ..... A61F 5/41  
482/49
- 5,243,968 A \* 9/1993 Byun ..... A61H 9/005  
600/38
- D403,075 S \* 12/1998 Lie ..... D24/200
- D677,393 S \* 3/2013 Green ..... D24/215
- D694,268 S \* 11/2013 Ohm ..... D15/7

- D723,587 S \* 3/2015 Park ..... D15/7
- 8,998,796 B2 \* 4/2015 Green ..... A61F 5/41  
439/38
- D755,925 S \* 5/2016 Park ..... D15/7
- D771,718 S \* 11/2016 Liao ..... D15/7

**OTHER PUBLICATIONS**

CAL Exotics, "Clitoral Pump", Jan. 2015, 1 page.

\* cited by examiner

*Primary Examiner* — Ralf Seifert

(74) *Attorney, Agent, or Firm* — Walter W. Duft

(57) **CLAIM**

The ornamental design for a hand-operable vacuum pump, as shown and described.

**DESCRIPTION**

FIG. 1 is a top perspective view of a hand-operable vacuum pump showing my new design, with the pump being connected to a vacuum chamber by way of a detachable tube. FIG. 2 is a bottom perspective view thereof. FIG. 3 is a front elevation view of thereof. FIG. 4 is a rear elevation view thereof. FIG. 5 is a right side elevation view thereof. FIG. 6 is a left side elevation view thereof. FIG. 7 is top view thereof; and, FIG. 8 is a bottom view thereof. The broken lines showing the detachable tube and vacuum chamber are for environmental purposes only and form no part of the claimed design.

**1 Claim, 8 Drawing Sheets**

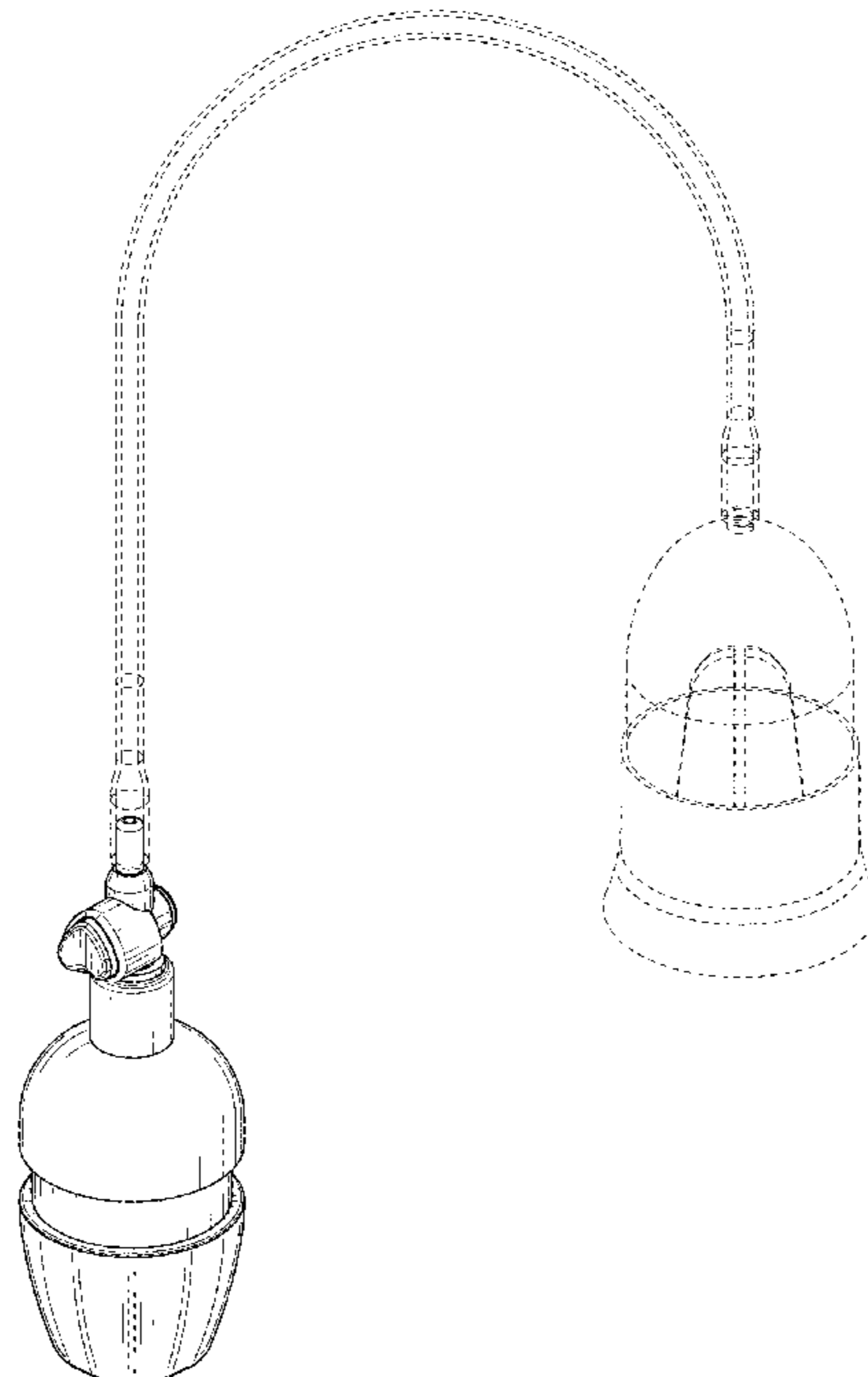

FIG. 1

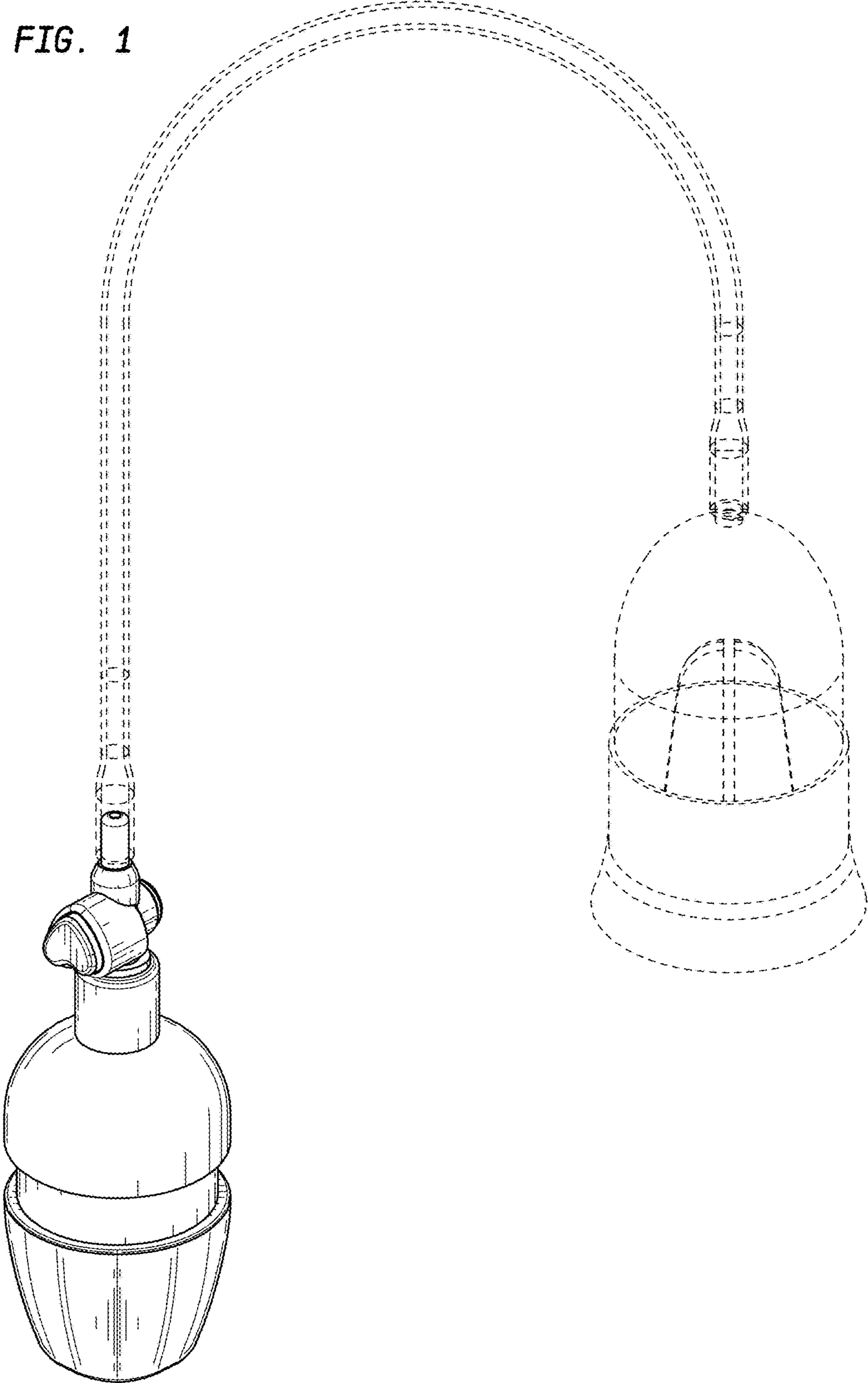

FIG. 2

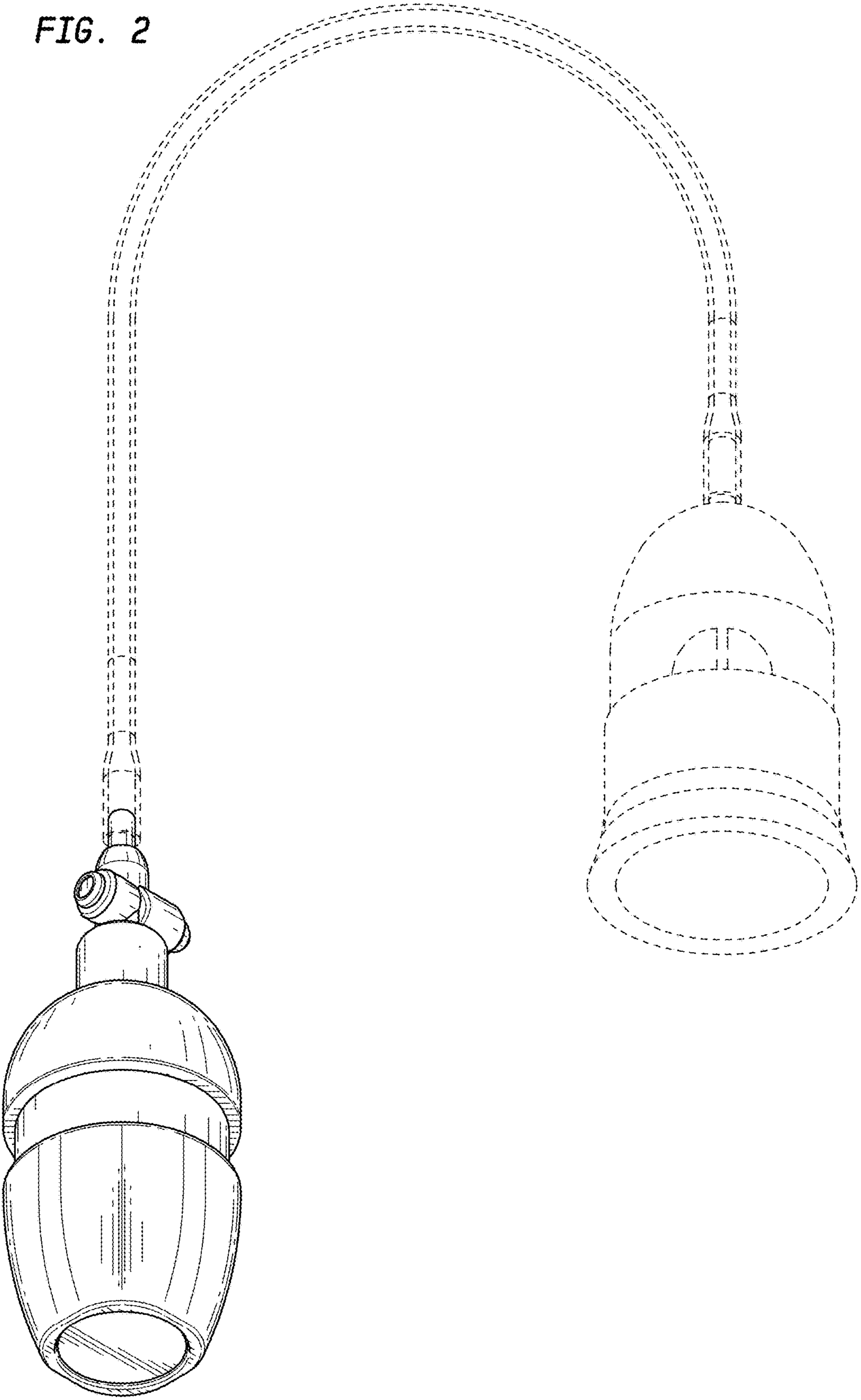

FIG. 3

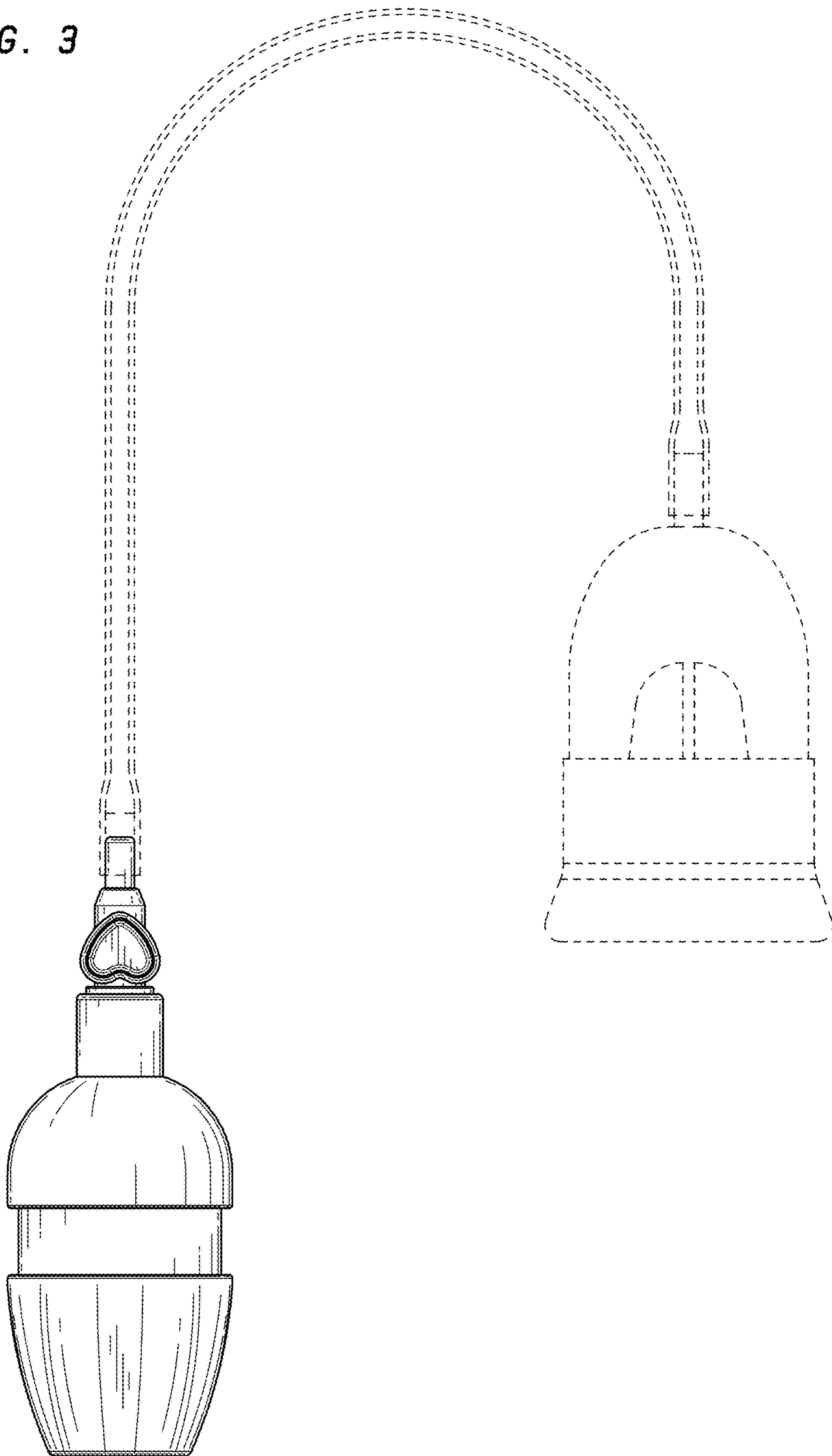

FIG. 4

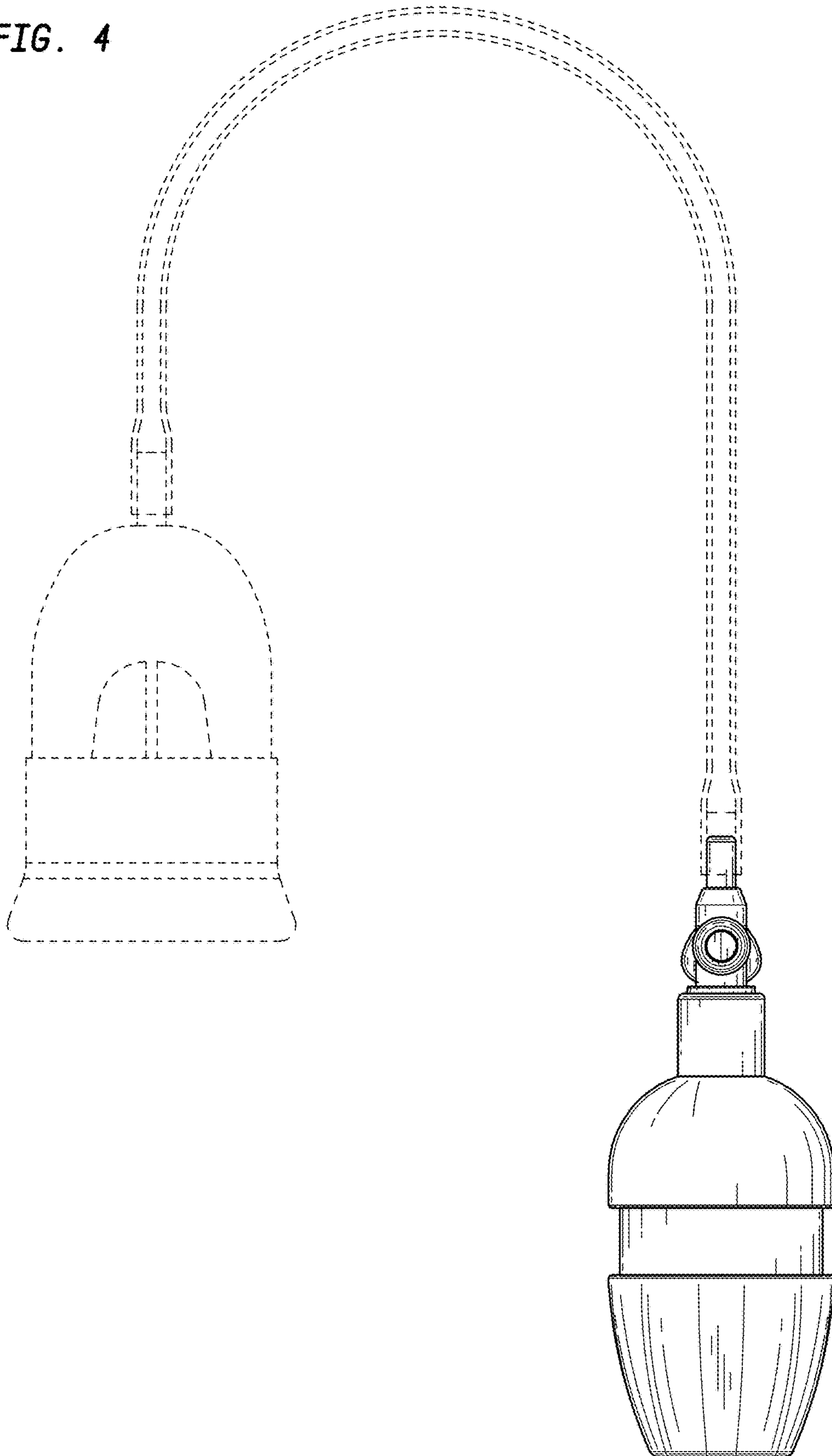



FIG. 5

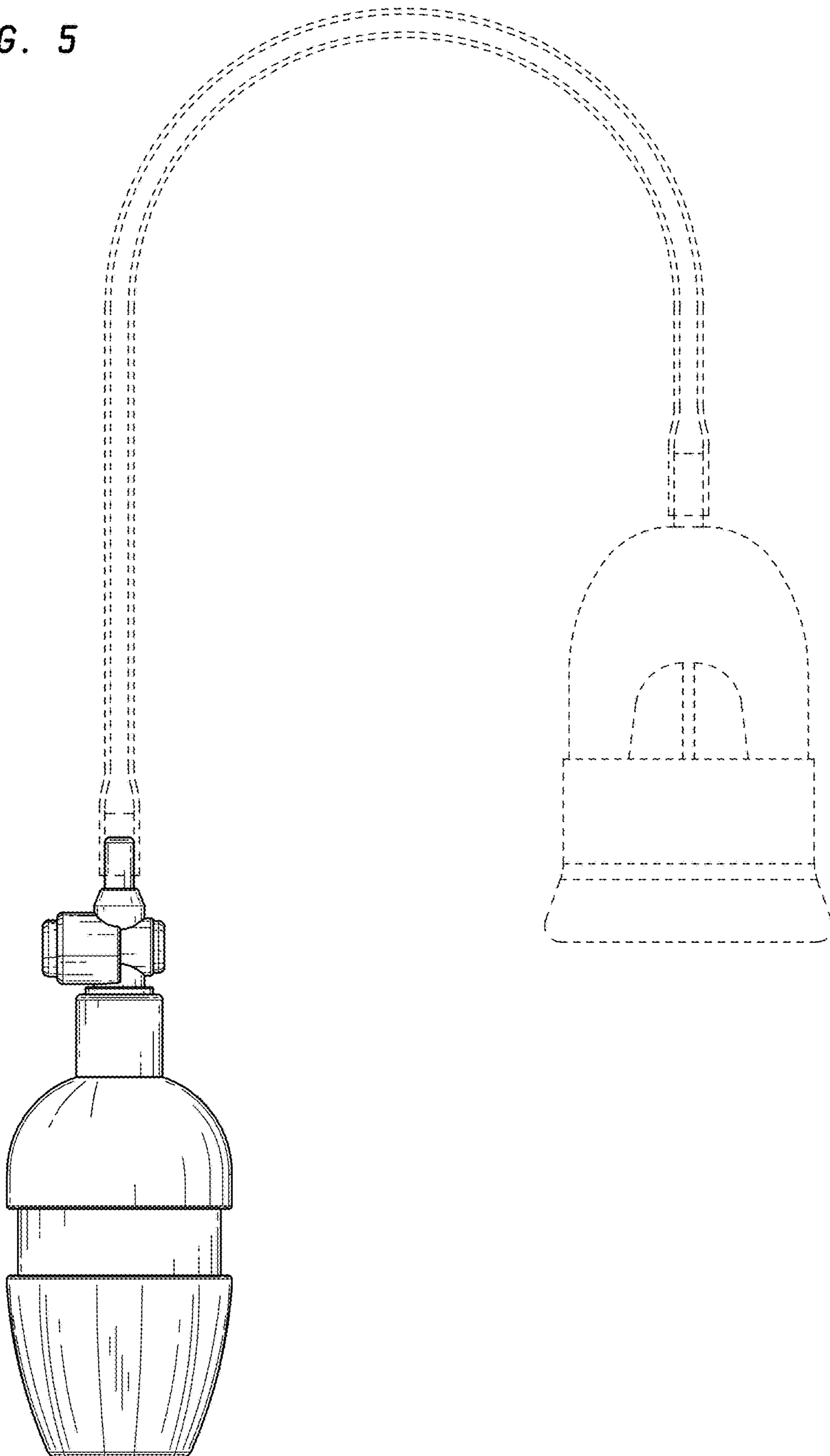

FIG. 6

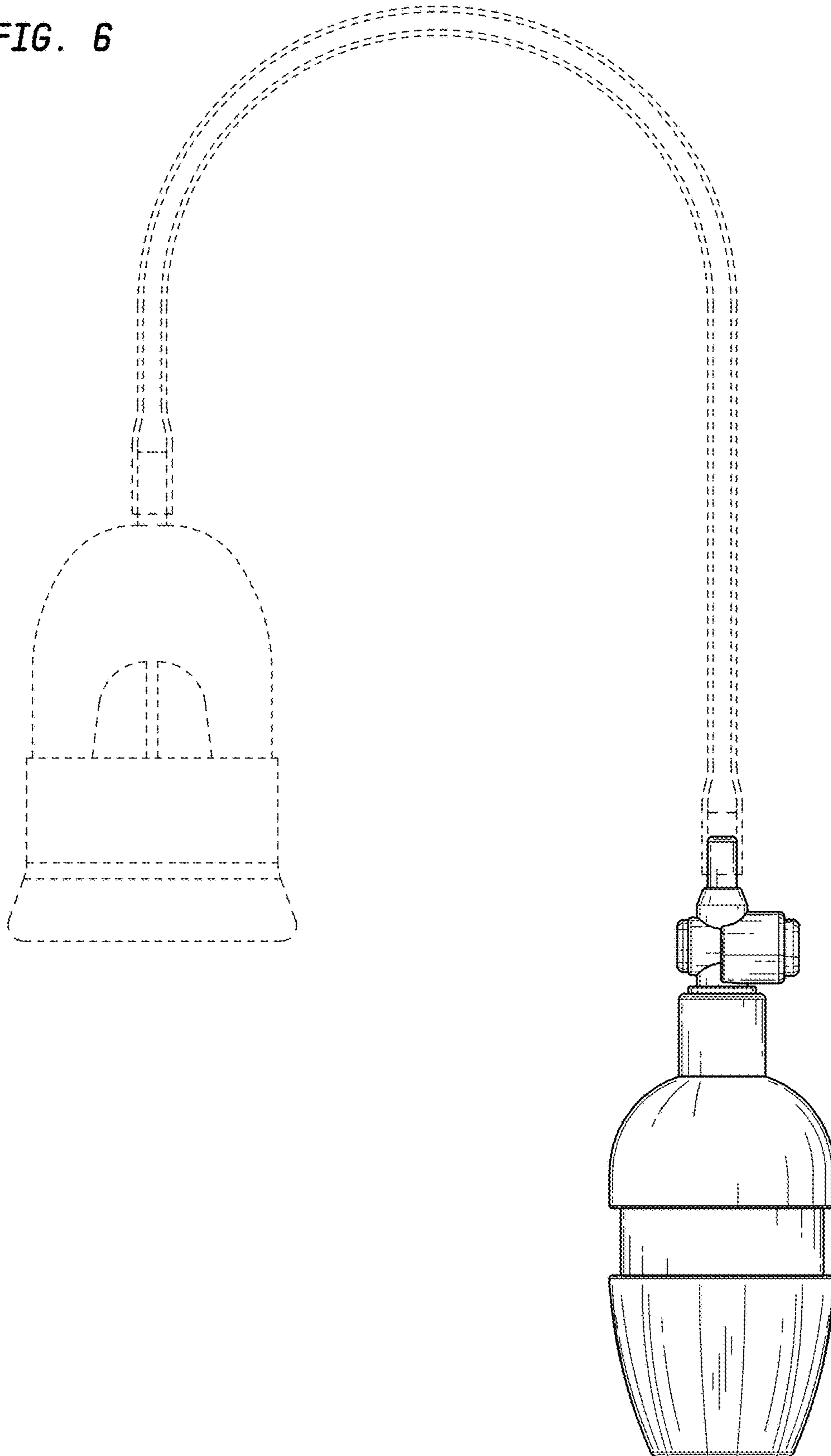
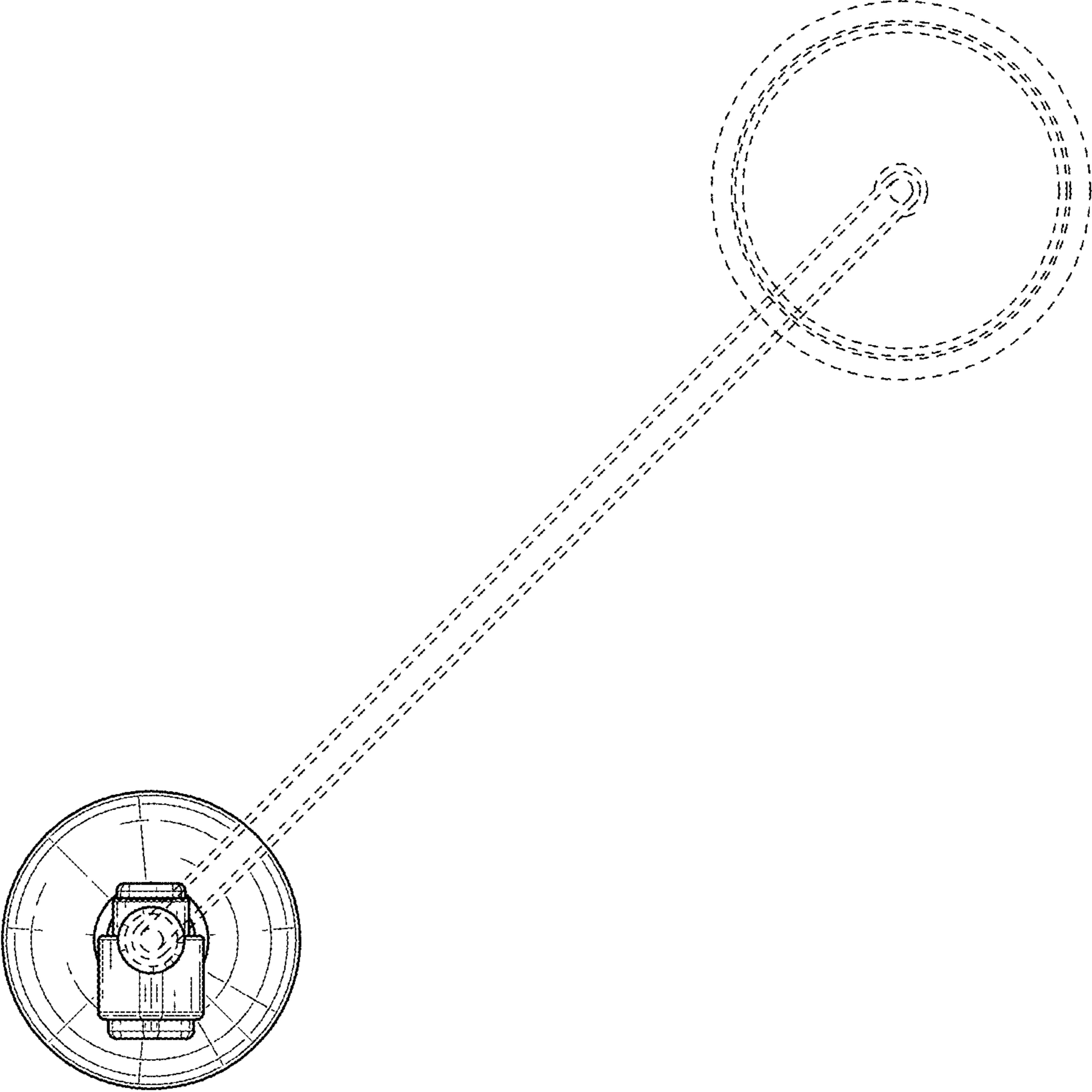

FIG. 7





*FIG. 8*

