



US00D807358S

(12) **United States Design Patent**  
**Huang et al.**

(10) **Patent No.:** **US D807,358 S**  
(45) **Date of Patent:** **\*\* Jan. 9, 2018**

(54) **DISPLAY DEVICE**

(71) Applicant: **Quanta Computer Inc.**, Taoyuan (TW)

(72) Inventors: **Peng-Yu Huang**, Taoyuan (TW);  
**Shih-Yun Lee**, Taoyuan (TW);  
**Gwo-Chyuan Chen**, Taoyuan (TW)

(73) Assignee: **QUANTA COMPUTER INC.**,  
Guishan Dist., Taoyuan (TW)

(\*\*) Term: **15 Years**

(21) Appl. No.: **29/594,130**

(22) Filed: **Feb. 15, 2017**

(30) **Foreign Application Priority Data**

Dec. 23, 2016 (TW) ..... 105307847

(51) **LOC (11) Cl.** ..... **14-02**

(52) **U.S. Cl.**  
USPC ..... **D14/372**

(58) **Field of Classification Search**  
USPC ..... D14/372, 496, 432, 371, 125, 126, 129,  
D14/299; D16/300-342; 351/158, 153,  
351/144; 345/7-9, 905; 455/344;  
348/115, 53, 121, 739  
CPC ..... G02B 27/017; G02B 27/0158; G02B  
27/0161; G02B 27/0181; G02B 27/0185;  
G02B 27/0189  
See application file for complete search history.

(56) **References Cited**

**U.S. PATENT DOCUMENTS**

D440,967 S \* 4/2001 Jung ..... D14/372  
D695,738 S \* 12/2013 Kumagai ..... D14/372

D704,706 S \* 5/2014 Serota ..... D14/372  
D719,953 S \* 12/2014 Nokuo ..... D14/372  
D740,815 S \* 10/2015 Bosveld ..... D14/372  
D753,112 S \* 4/2016 Fei ..... D14/372  
D764,467 S \* 8/2016 Nokuo ..... D14/372  
D776,110 S \* 1/2017 Gribetz ..... D14/372  
D778,909 S \* 2/2017 Nokuo ..... D14/372  
D785,619 S \* 5/2017 Su ..... D14/372  
D791,129 S \* 7/2017 Sullivan ..... D14/372  
D792,399 S \* 7/2017 Thomas ..... D14/372  
D795,867 S \* 8/2017 Huang ..... D14/372  
D796,507 S \* 9/2017 Chen ..... D14/372  
D798,298 S \* 9/2017 Haber ..... D14/372  
D798,862 S \* 10/2017 Wang ..... D14/372  
D800,117 S \* 10/2017 Yee ..... D14/372  
D800,726 S \* 10/2017 Su ..... D14/372  
D800,727 S \* 10/2017 Mullins ..... D14/372

\* cited by examiner

*Primary Examiner* — Austin Murphy

(74) *Attorney, Agent, or Firm* — McClure, Qualey &  
Rodack, LLP

(57) **CLAIM**

The design for display device, is as shown and described.

**DESCRIPTION**

FIG. 1 is a front perspective view of a display device, such as a head mounted display, a virtual reality display, an augmented reality display, or a mixed reality display, in accordance with our new design;  
FIG. 2 is a front view thereof;  
FIG. 3 is a rear view thereof;  
FIG. 4 is a left side view thereof;  
FIG. 5 is a right side view thereof;  
FIG. 6 is a top view thereof; and  
FIG. 7 is a bottom view thereof; and,  
FIG. 8 is a rear perspective view thereof.

**1 Claim, 8 Drawing Sheets**

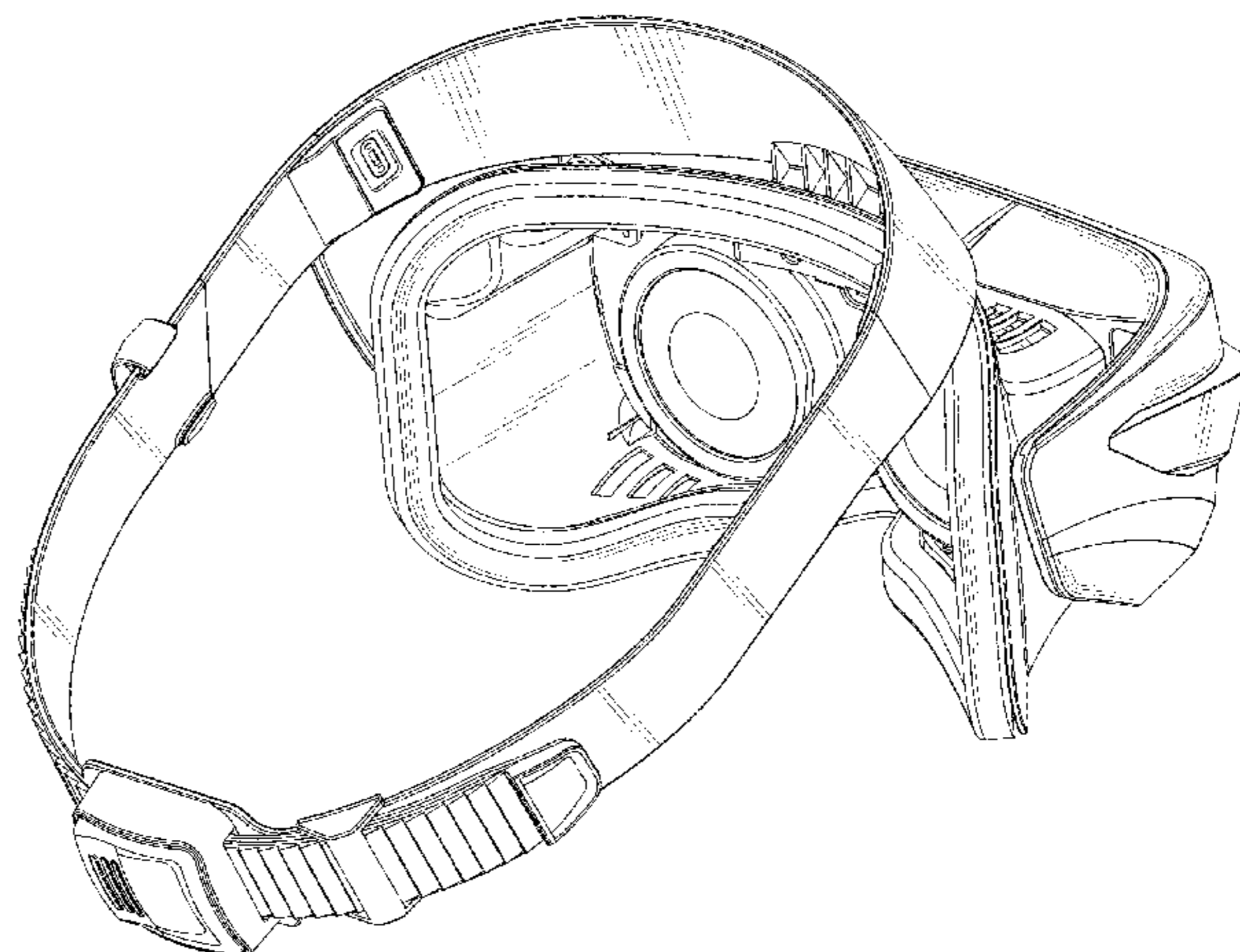
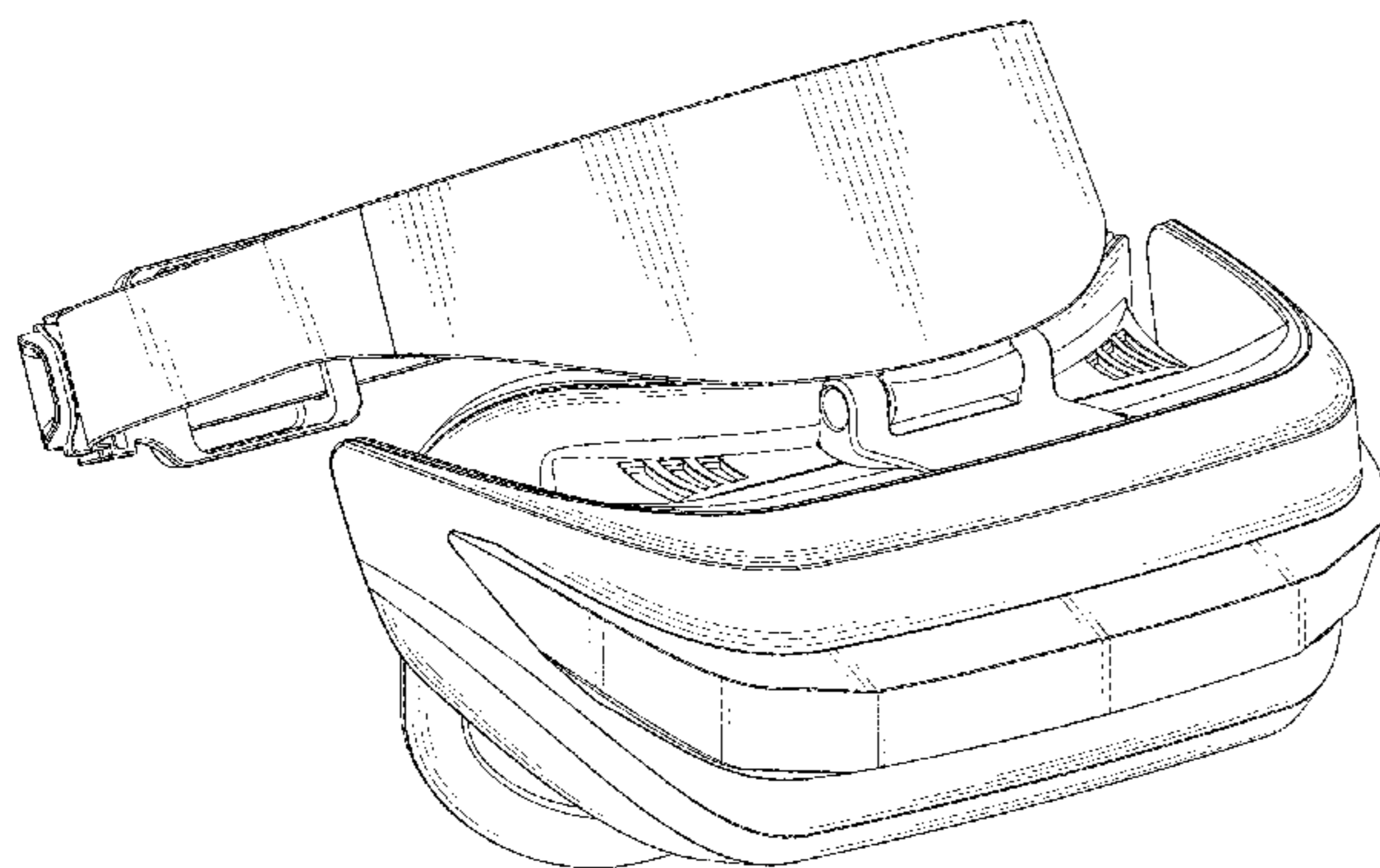

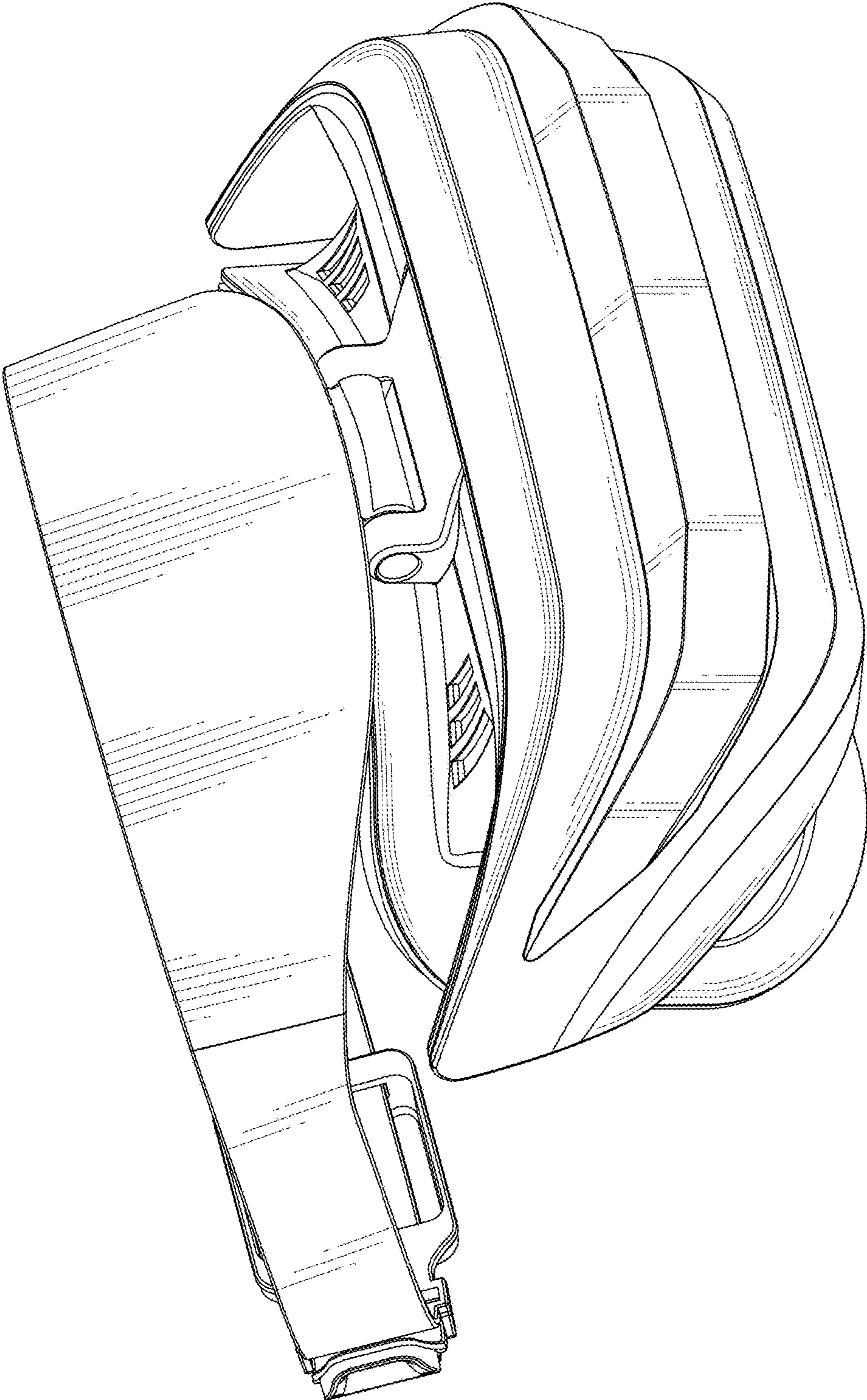

FIG. 1

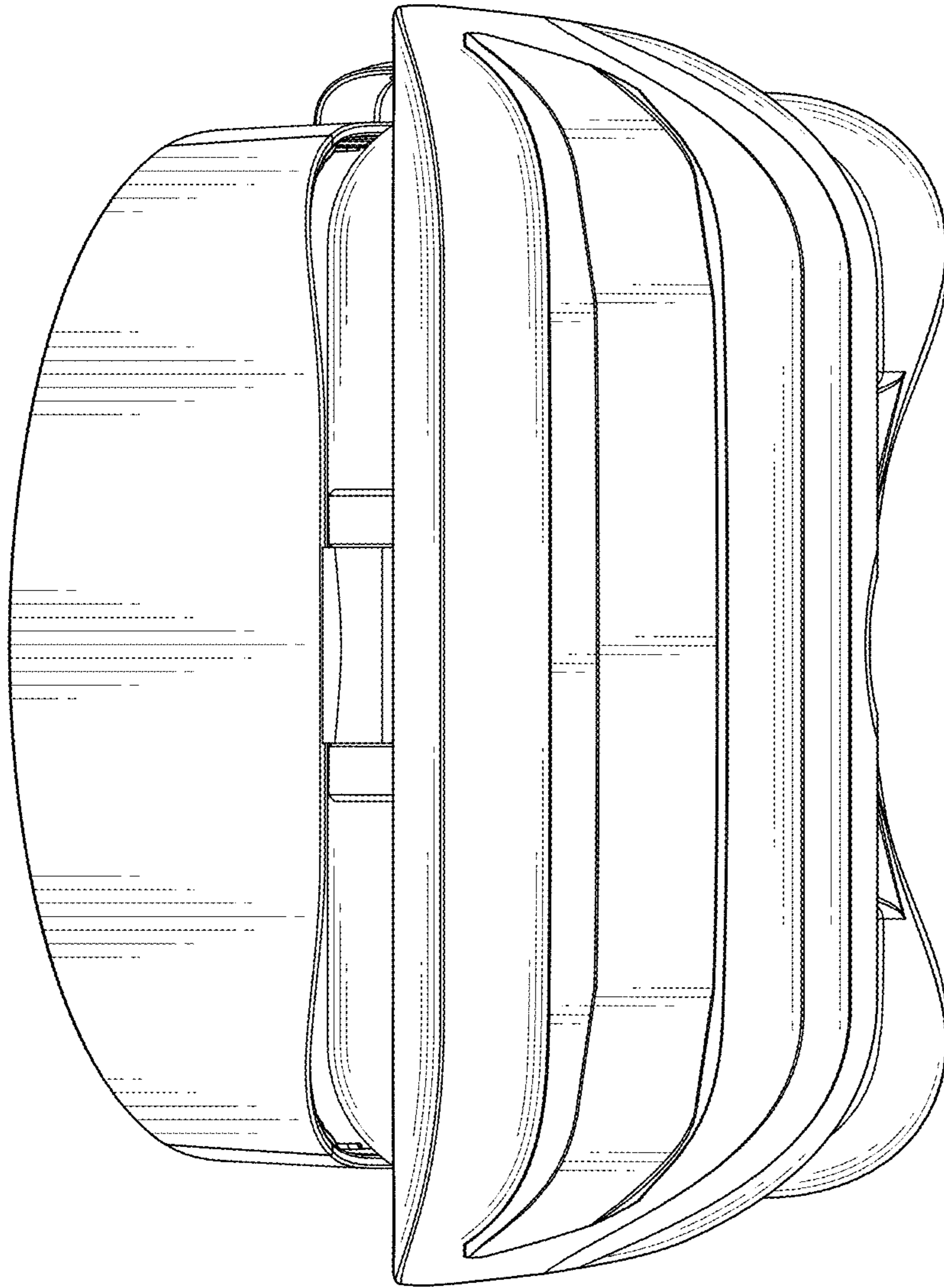

FIG. 2

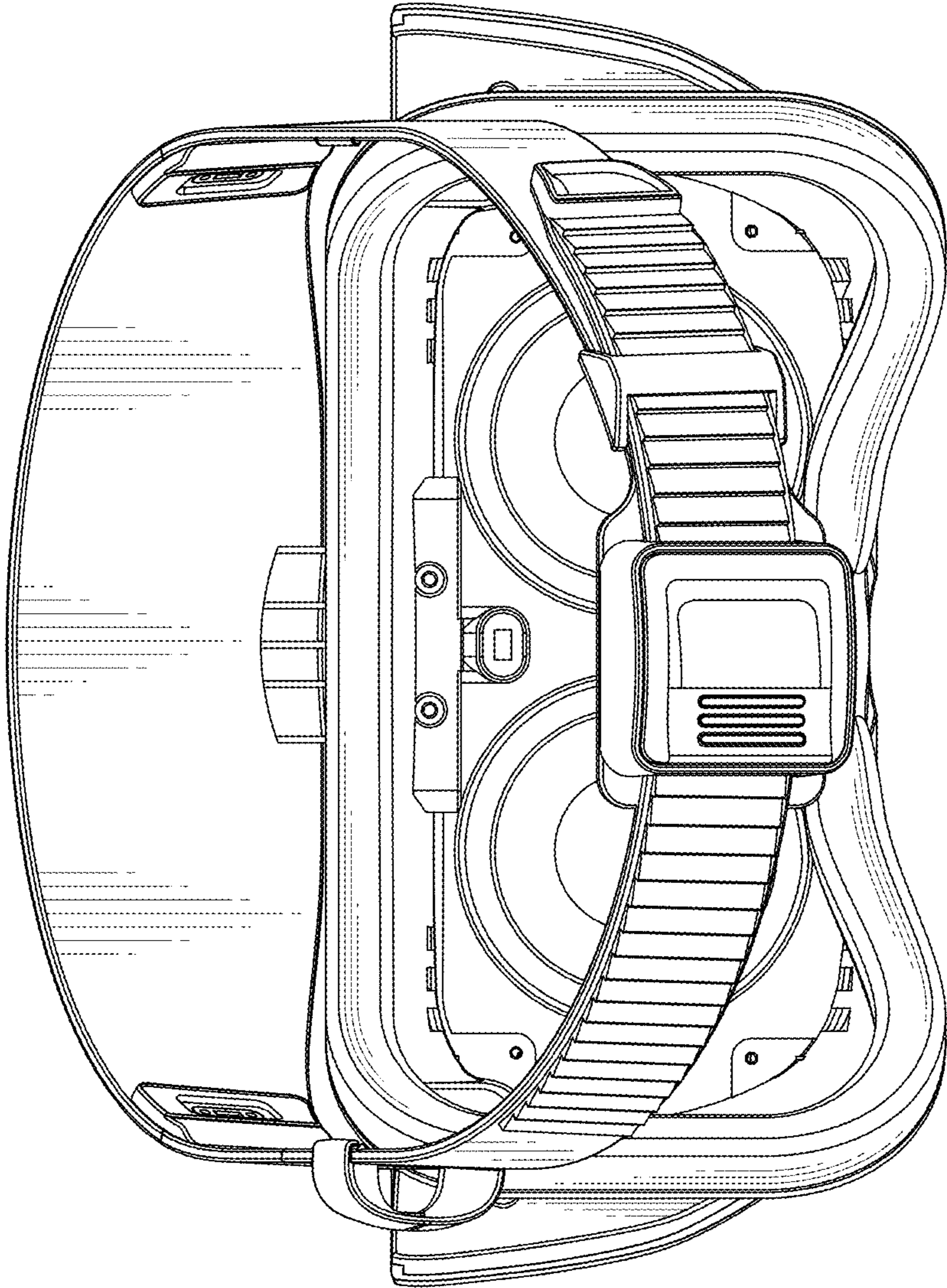

FIG. 3

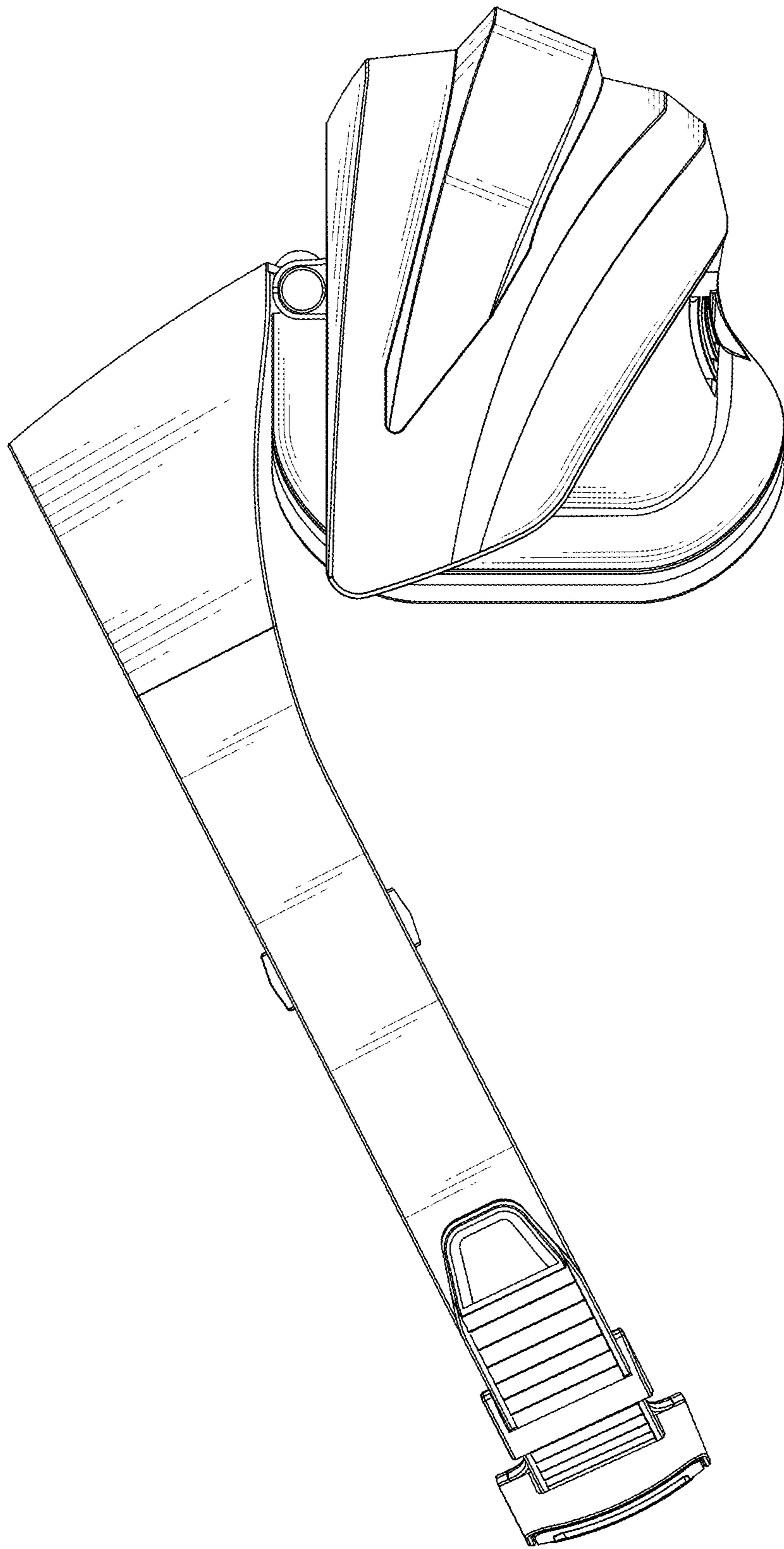

FIG. 4

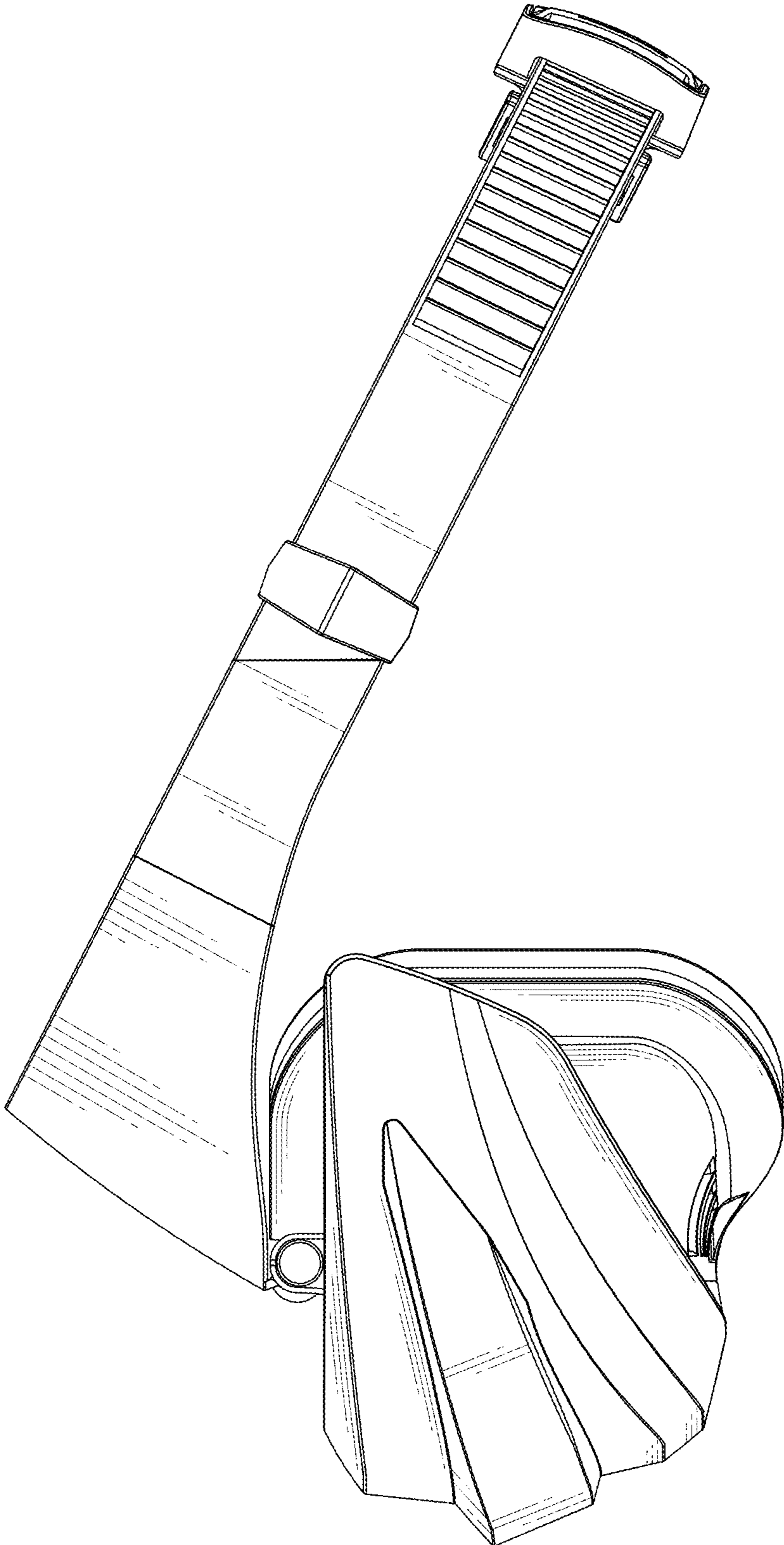

FIG. 5

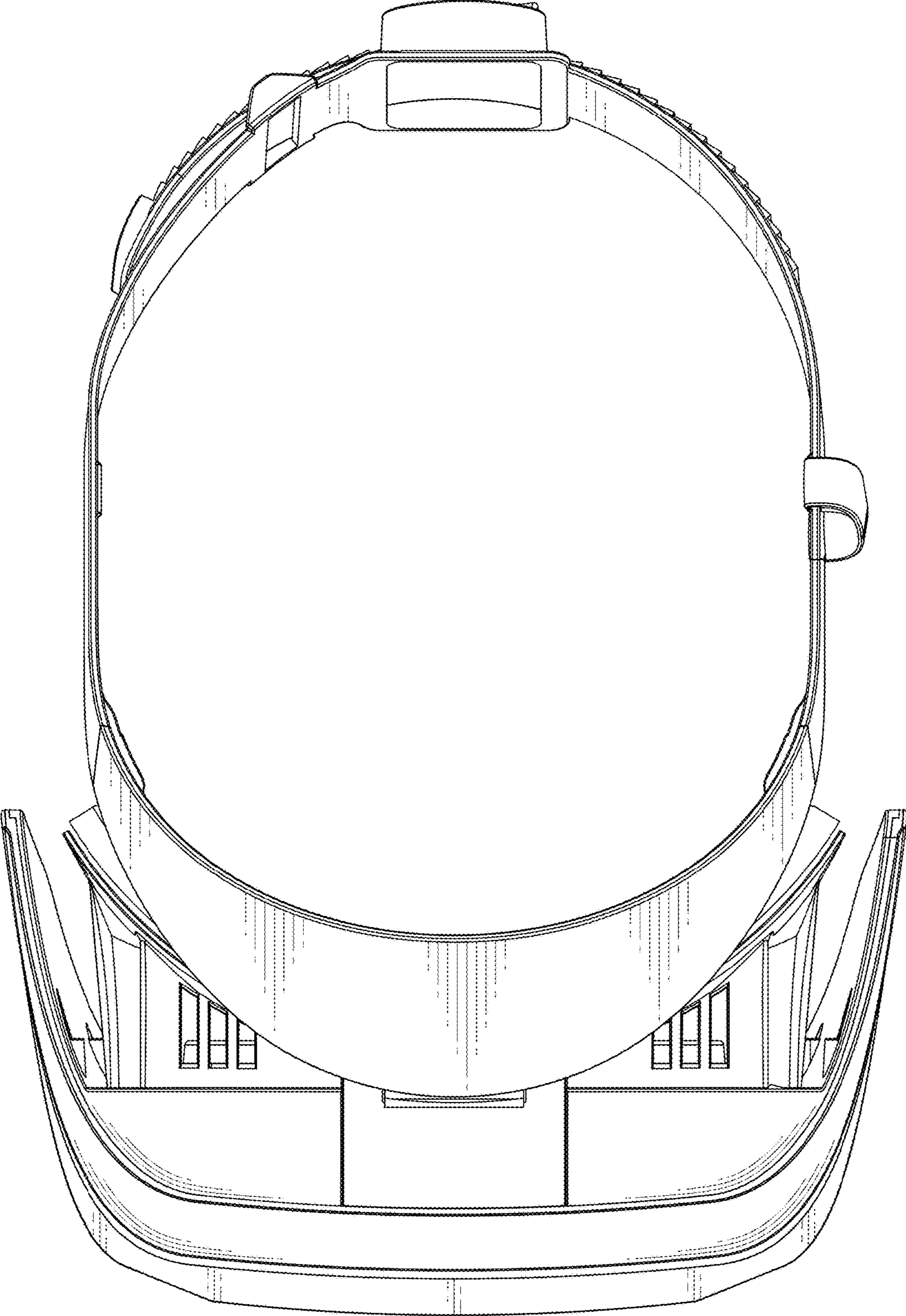

FIG. 6

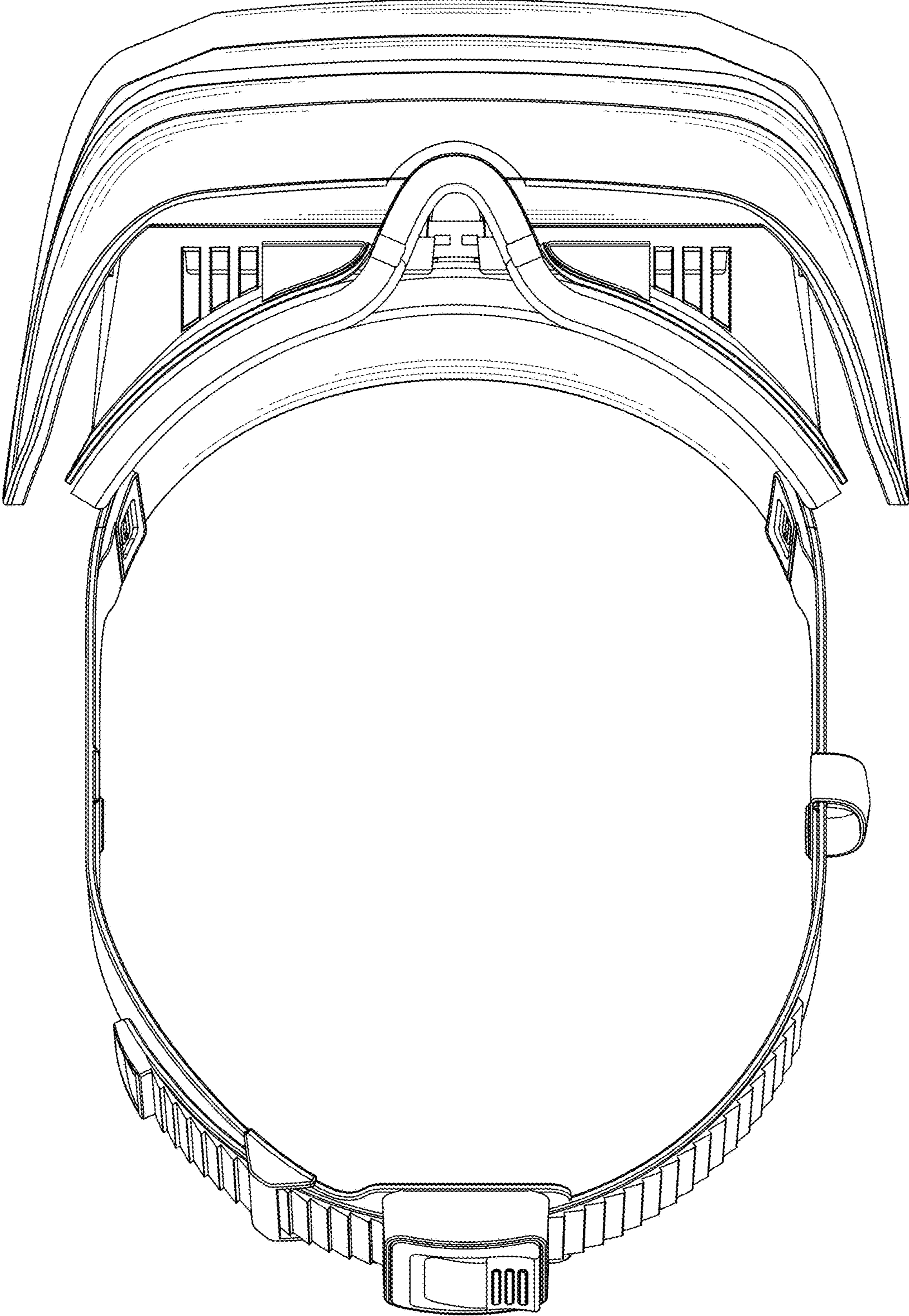

FIG. 7



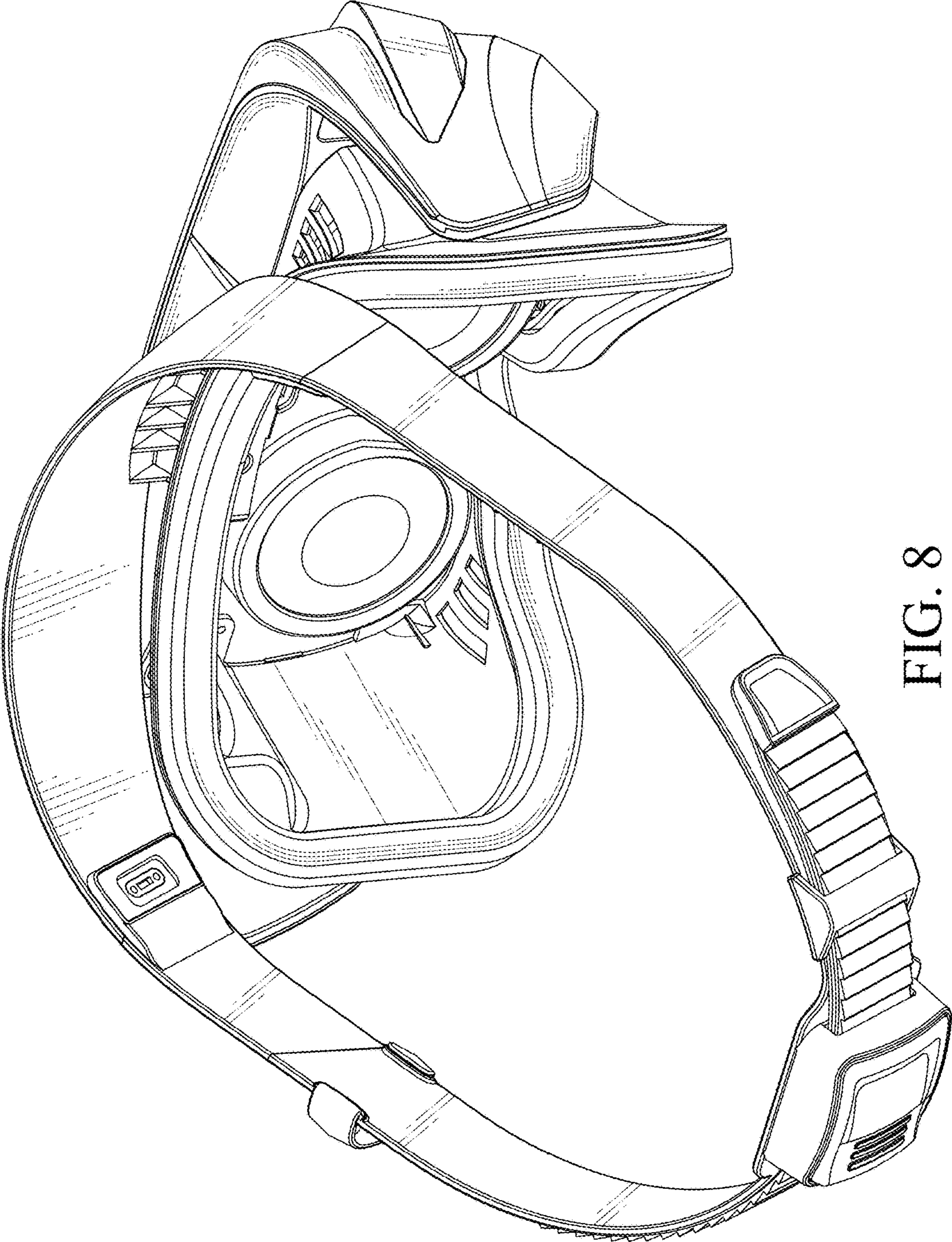

FIG. 8