



US00D807341S

(12) **United States Design Patent** (10) **Patent No.:** **US D807,341 S**
Shi (45) **Date of Patent:** **** Jan. 9, 2018**

(54) **ELECTRONIC DEVICE**

(71) Applicant: **Lenovo (Beijing) Co., Ltd.**, Beijing (CN)

(72) Inventor: **Wenbo Shi**, Beijing (CN)

(73) Assignee: **LENOVO (BEIJING) CO., LTD.**, Beijing (CN)

(**) Term: **15 Years**

(21) Appl. No.: **29/547,217**

(22) Filed: **Dec. 2, 2015**

Related U.S. Application Data

(62) Division of application No. 29/483,811, filed on Mar. 3, 2014, now Pat. No. Des. 748,089.

(30) **Foreign Application Priority Data**

Sep. 2, 2013 (CN) 2013 3 0424816

(51) **LOC (11) Cl.** **14-02**

(52) **U.S. Cl.**
USPC **D14/315**

(58) **Field of Classification Search**
USPC D14/315-327; D18/1, 2, 7, 11;
235/145 A, 145 R; 341/22, 23; 345/104,
(Continued)

(56) **References Cited**

U.S. PATENT DOCUMENTS

D425,874 S * 5/2000 Tanimura D14/318
6,775,129 B1 8/2004 Ghosh et al.
(Continued)

Primary Examiner — Freda S Nunn

(74) *Attorney, Agent, or Firm* — Oppedahl Patent Law Firm LLC

(57) **CLAIM**

The ornamental design for an electronic device, as shown and described.

DESCRIPTION

FIG. 1 is a front elevational view of an electronic device showing the new design;
FIG. 2 is a back elevational view thereof;
FIG. 3 is a left side elevational view thereof;
FIG. 4 is a right side elevational view thereof;
FIG. 5 is a top plan view thereof;
FIG. 6 is a bottom plan view thereof;
FIG. 7 is a front elevational view thereof with the lid being in a first open position, it being understood that all other surfaces are the same;
FIG. 8 is a left side elevational view thereof;
FIG. 9 is a right side elevational view thereof;
FIG. 10 is a top plan view thereof;
FIG. 11 is a bottom plan view thereof;
FIG. 12 is a top perspective view thereof;
FIG. 13 is a front elevational view thereof with the lid being in a second open position, it being understood that all other surfaces are the same;
FIG. 14 is a back elevational view thereof;
FIG. 15 is a left side elevational view thereof;
FIG. 16 is a right side elevational view thereof;
FIG. 17 is a top plan view thereof;
FIG. 18 is a right side perspective view thereof;
FIG. 19 is a back elevational view with the lid being in a third open position, it being understood that all other surfaces are the same;
FIG. 20 is a left side elevational view thereof;
FIG. 21 is a right side elevational view thereof;
FIG. 22 is a top plan view thereof;
FIG. 23 is a bottom plan view thereof;
FIG. 24 is a top side perspective view thereof wherein the keyboard surface is face down on a supporting surface;
FIG. 25 is a top side back perspective view thereof wherein the front edges are touching a supporting surface;
FIG. 26 is a top front side perspective view thereof;
FIG. 27 is a back elevational view thereof with the lid being in a fourth position, it being understood that all other surfaces are the same;

(Continued)

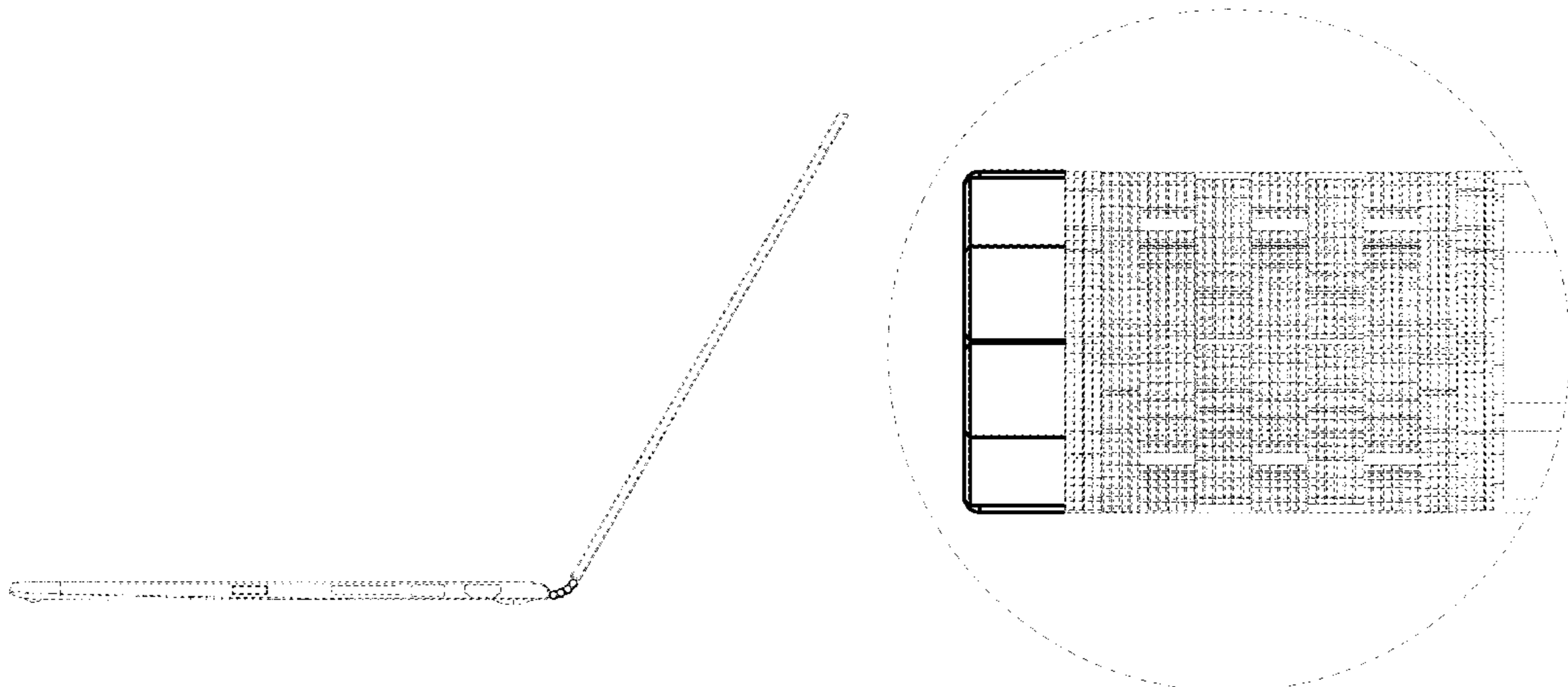

FIG. 28 is a left side elevational view thereof;
 FIG. 29 is a right side elevational view thereof;
 FIG. 30 is a top plan view thereof;
 FIG. 31 is a bottom plan view thereof;
 FIG. 32 is a back side perspective view thereof;
 FIG. 33 is a back elevational view;
 FIG. 34 is an enlarged partial view of FIG. 33; and,
 FIG. 35 is an enlarged partial view of FIG. 33.
 The features shown in broken lines in the drawings depict environmental subject matter and form no part of the claimed design.
 The areas identified as A1, A2, A3 and A4 in FIG. 33 are understood to be drawn entirely in broken lines and form no part of the claimed design.

1 Claim, 21 Drawing Sheets

(58) **Field of Classification Search**

USPC 345/156, 168, 169, 173; 361/679.08,
 361/679.09, 679.11, 679.26, 679.27
 CPC G06F 1/16; G06F 1/1616; G06F 1/1626;
 G06F 1/1632; G06F 1/1613; G06F
 1/1601; G06F 1/1618; G06F 1/162; G06F
 1/166; G06F 1/1654; G06F 1/1681; G06F
 1/1637; G06F 1/1688; G06F 1/1656;

H01R 35/02; H03M 11/00; G09B 13/04;
 H03K 17/94; G09G 5/00; F16M 11/10;
 H05K 5/00; H04M 1/0237; H04M 1/0216
 See application file for complete search history.

(56)

References Cited

U.S. PATENT DOCUMENTS

D631,472	S	1/2011	Kawase et al.	
D631,879	S	2/2011	Kawase	
D651,206	S	12/2011	Kim et al.	
D675,611	S	2/2013	Wen et al.	
8,891,231	B2 *	11/2014	Okuley	G06F 1/1616 318/400.26
D719,149	S *	12/2014	Matsuoka	D14/318
D734,759	S *	7/2015	Myung	D14/439
2003/0103324	A1 *	6/2003	Gallivan	G06F 1/1616 361/679.27
2006/0146488	A1 *	7/2006	Kimmel	G06F 1/1616 361/679.04
2007/0117600	A1 *	5/2007	Robertson, Jr.	H04M 1/0216 455/575.3
2014/0196253	A1 *	7/2014	Song	G06F 1/1601 16/225
2015/0077917	A1 *	3/2015	Song	G06F 1/1681 361/679.27

* cited by examiner

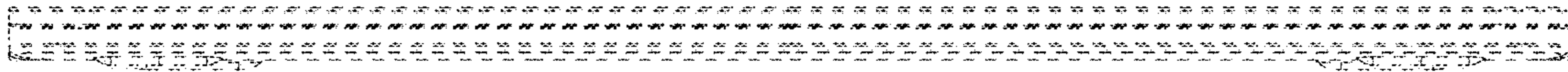

Fig. 1



Fig. 2

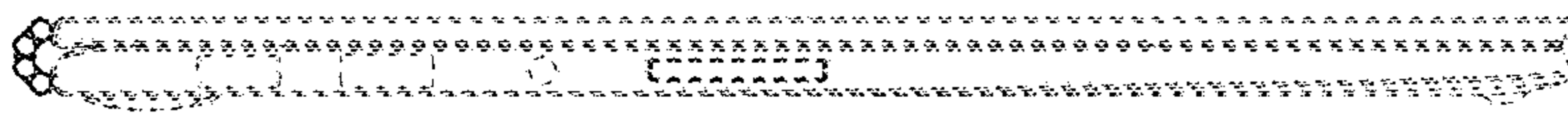

Fig. 3

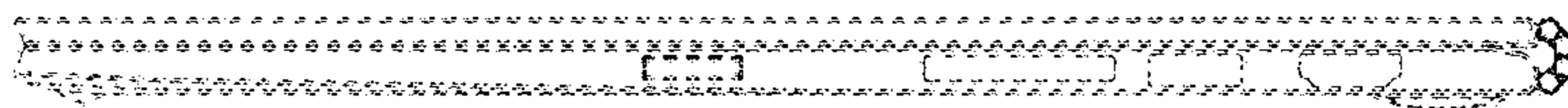

Fig. 4

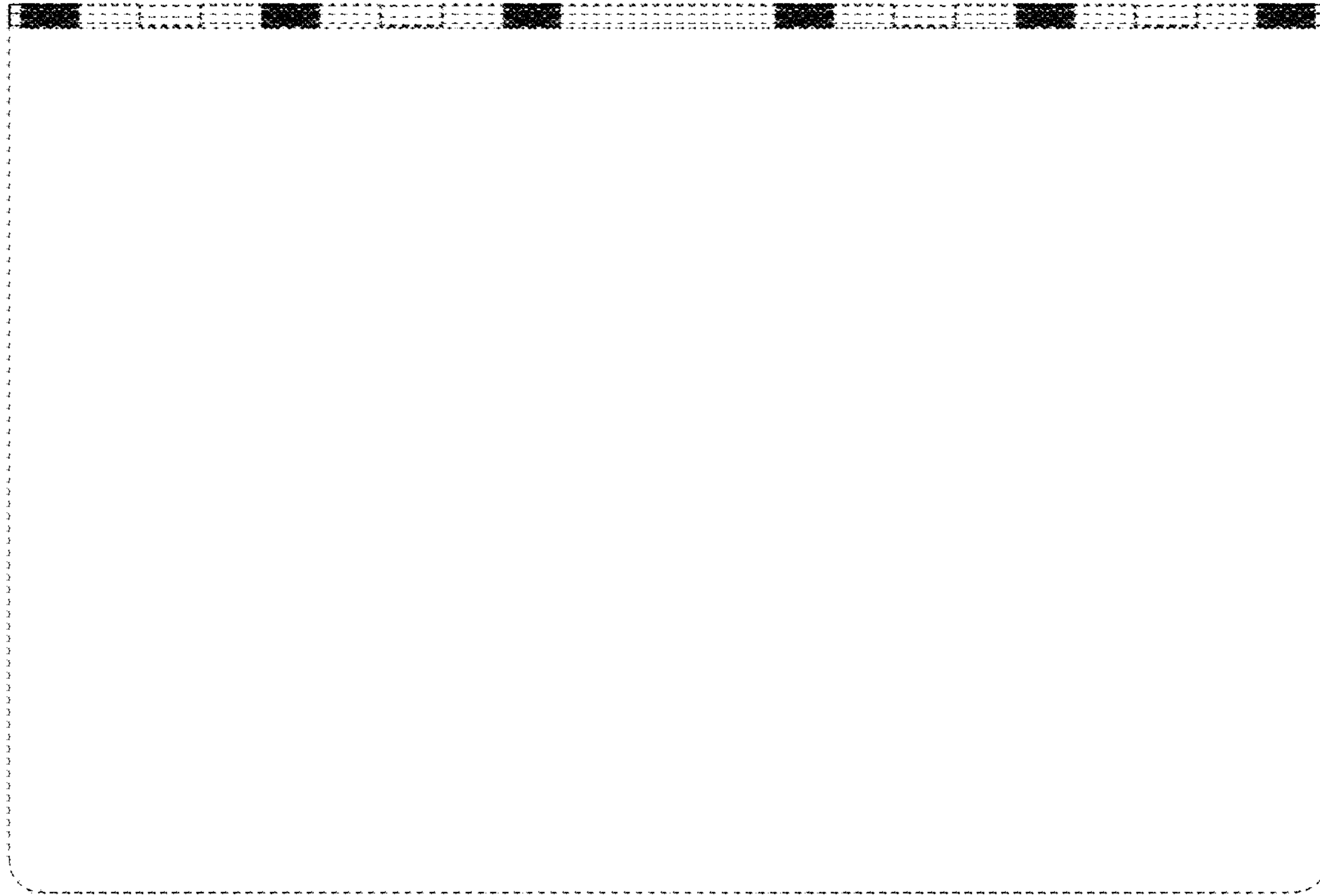

Fig.5

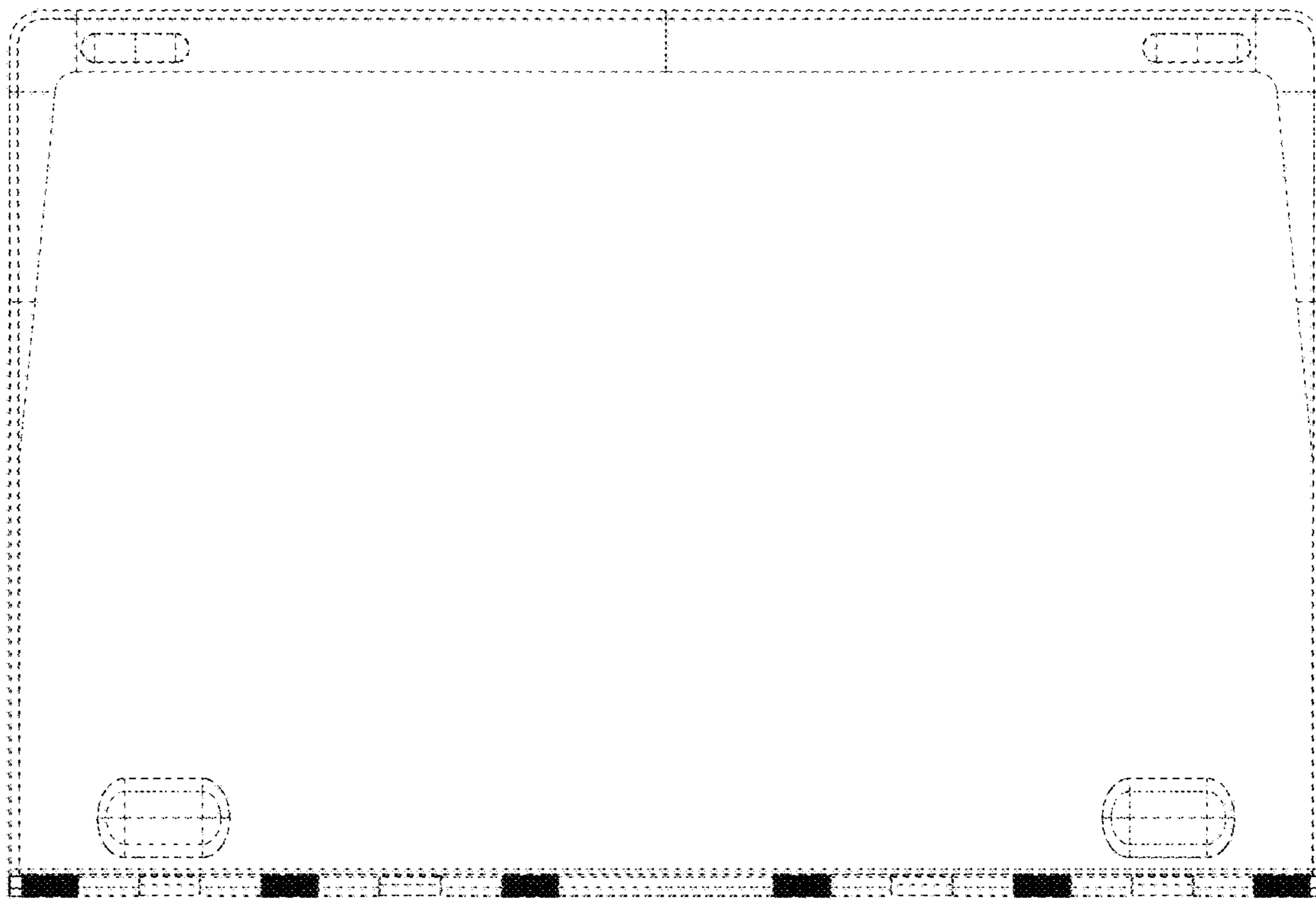

Fig.6

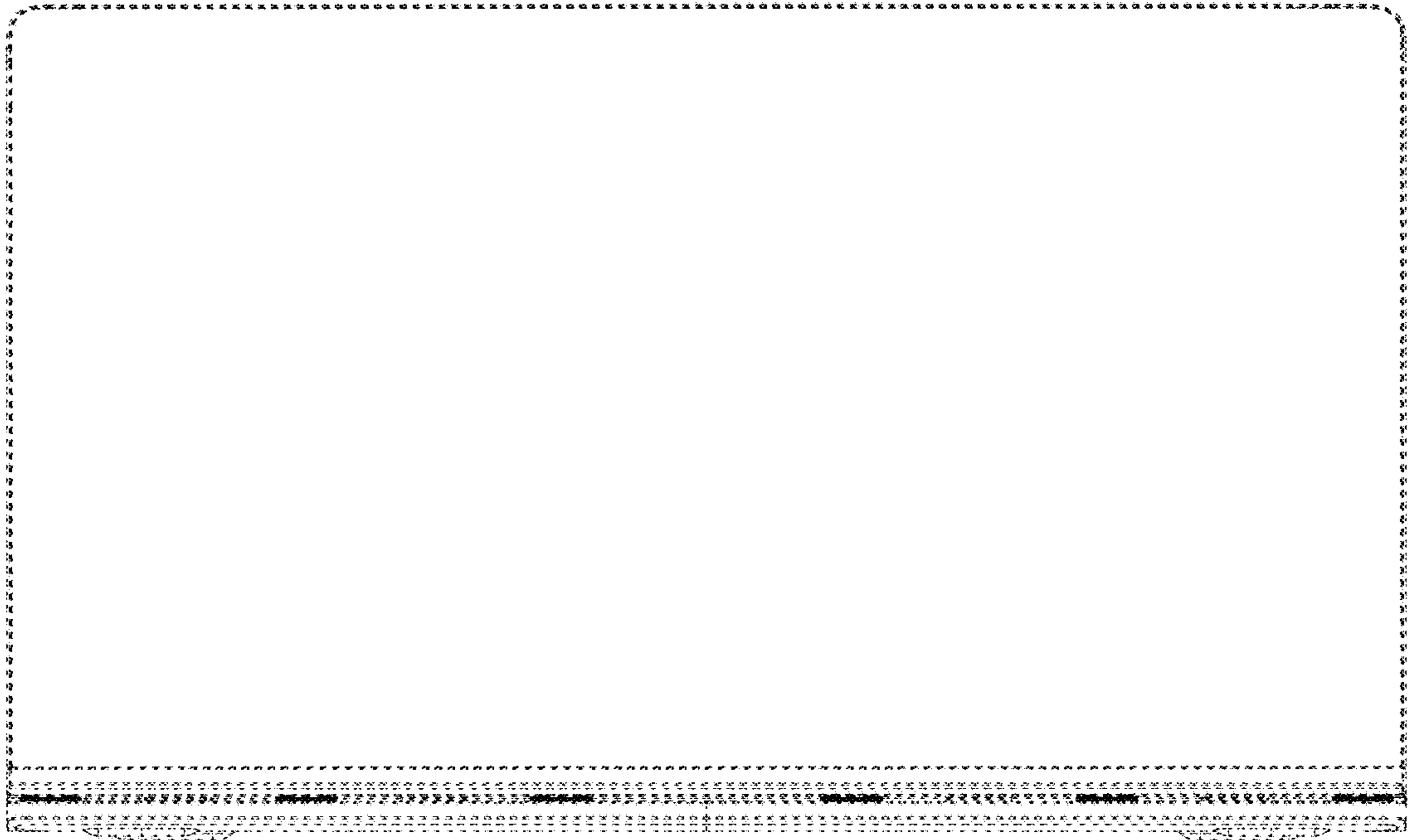

Fig.7

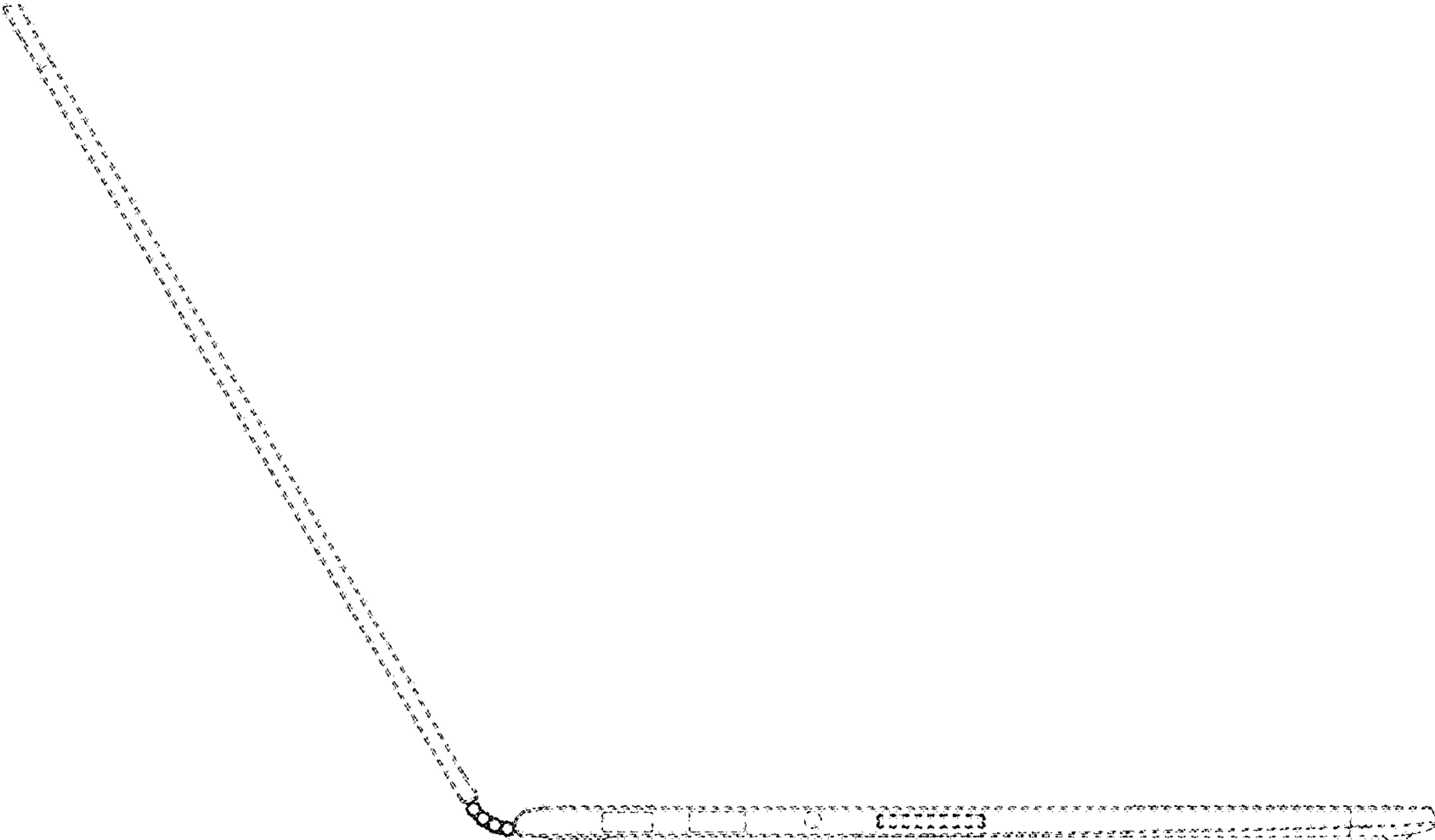

Fig.8

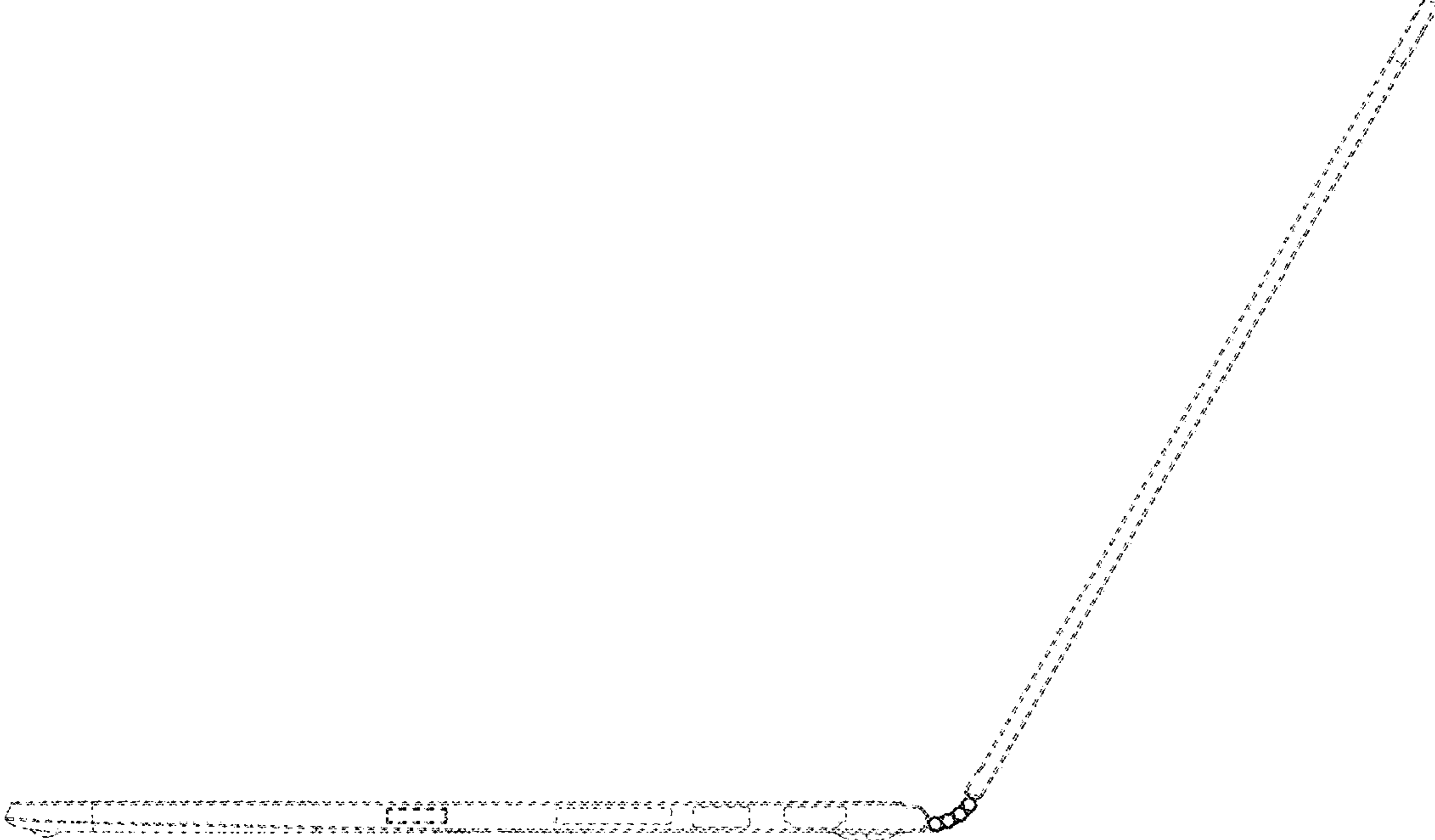

Fig.9

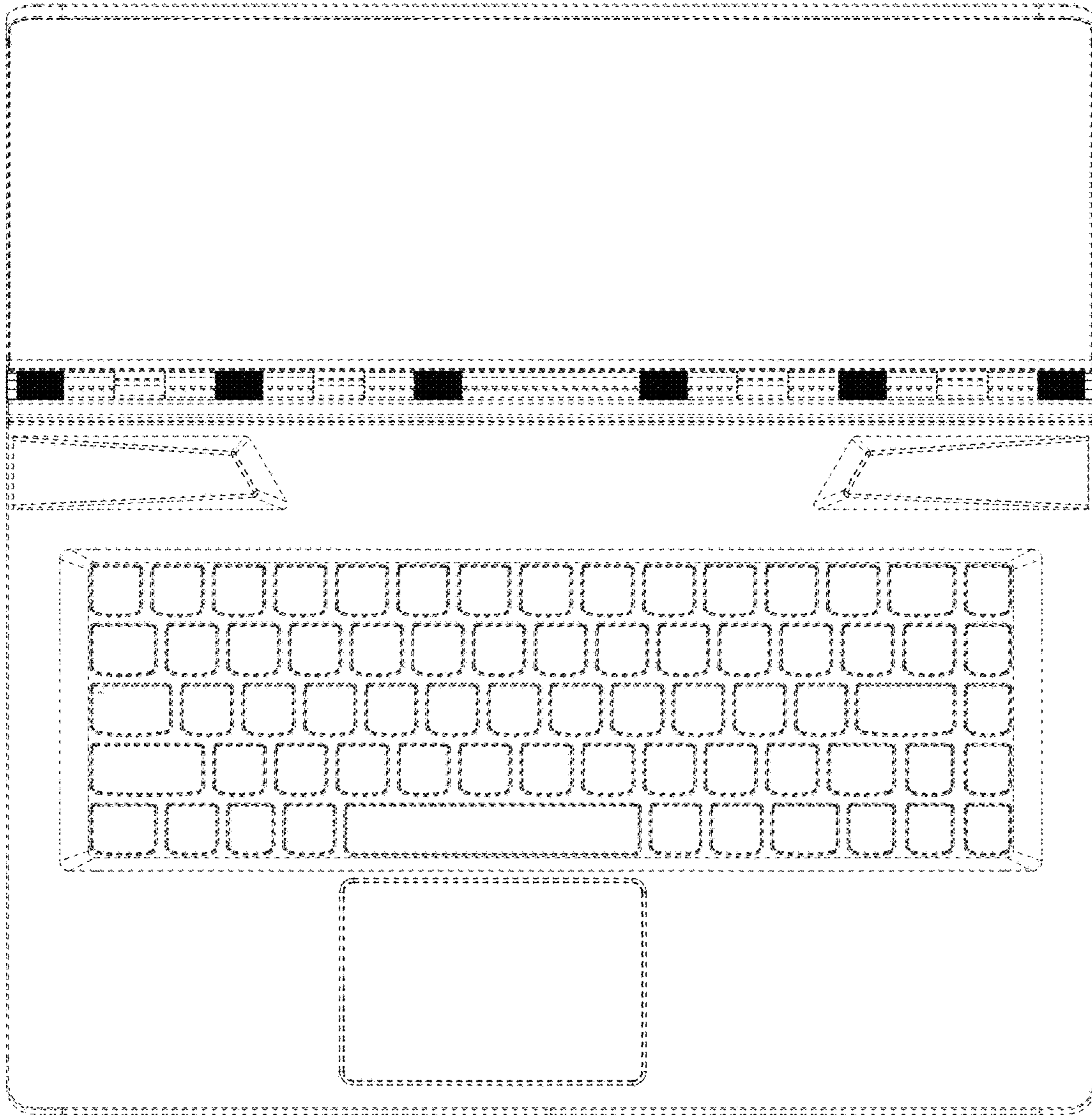

Fig.10

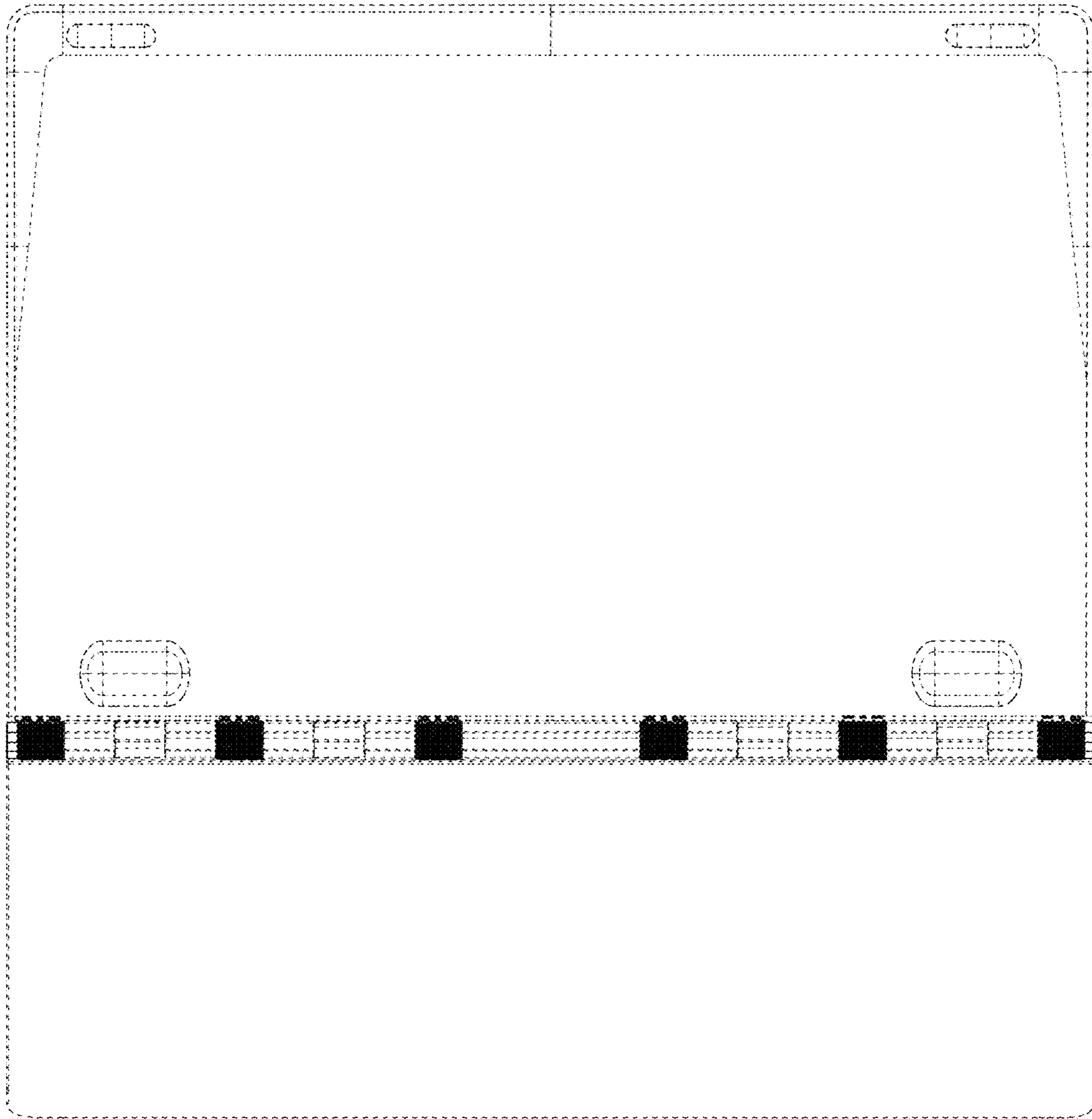

Fig.11

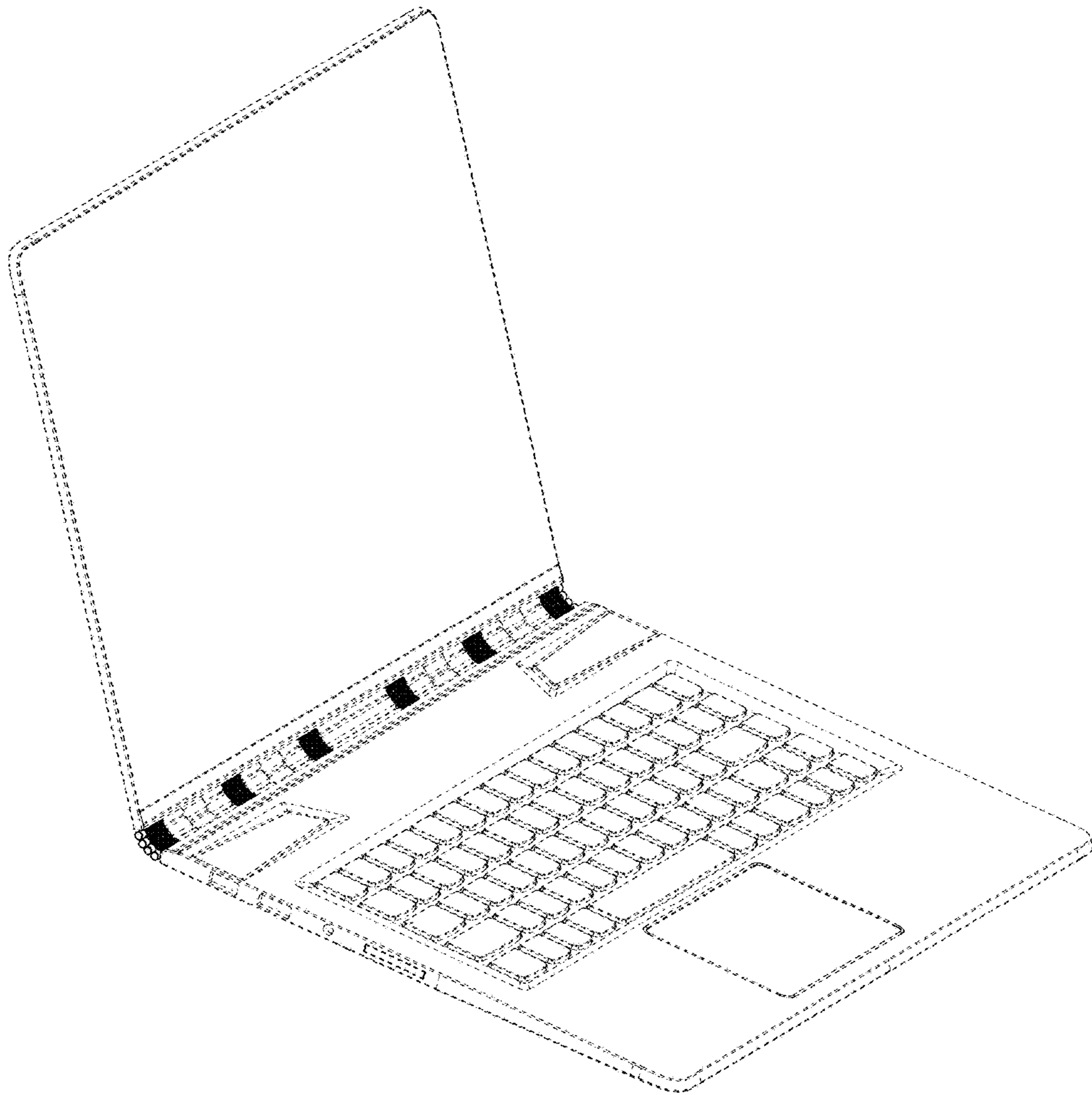

Fig.12

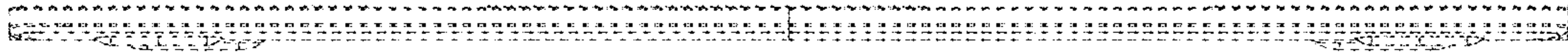

Fig.13

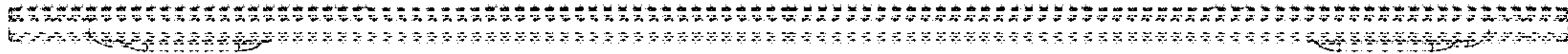

Fig.14



Fig. 15



Fig. 16

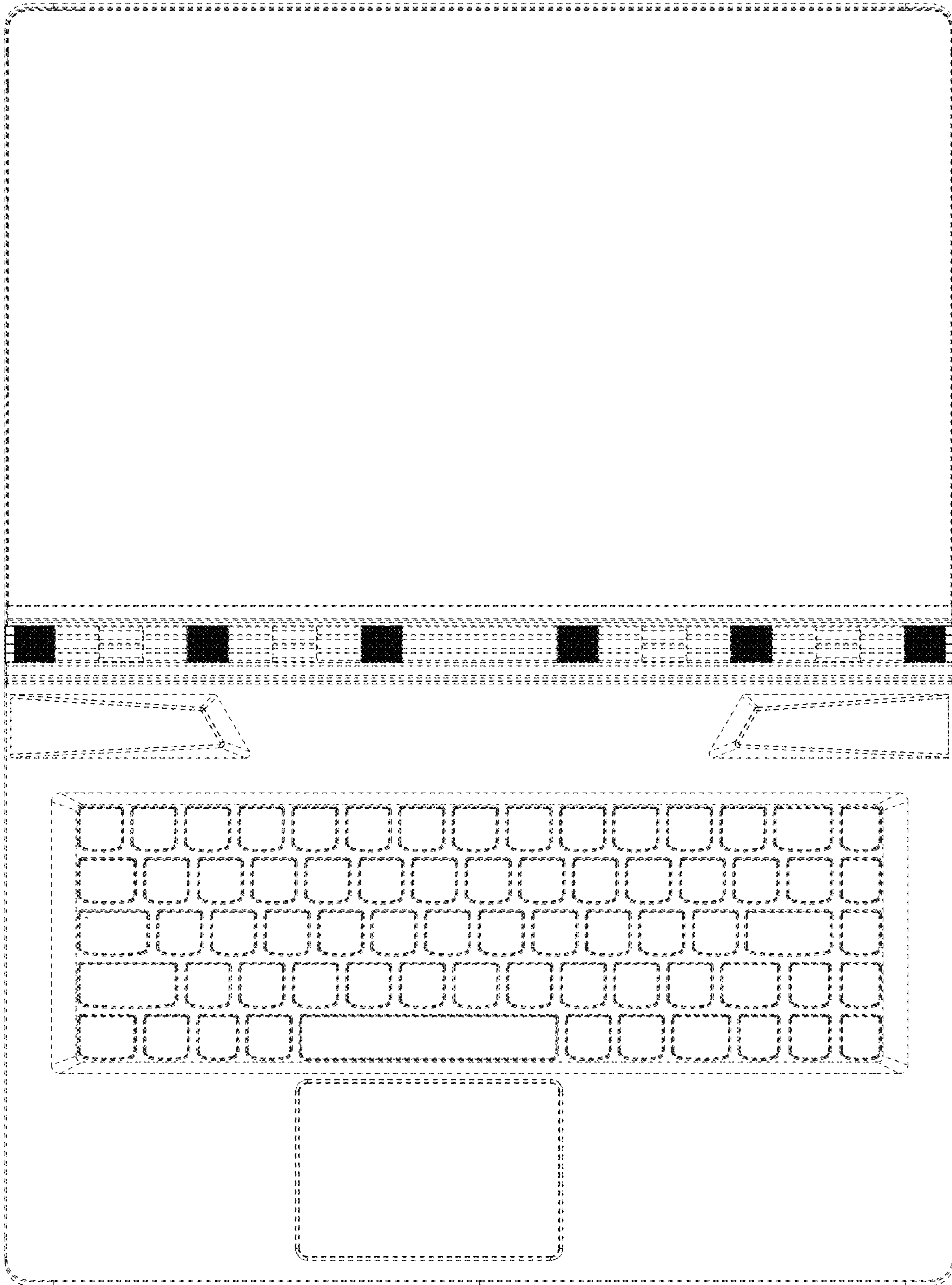

Fig.17

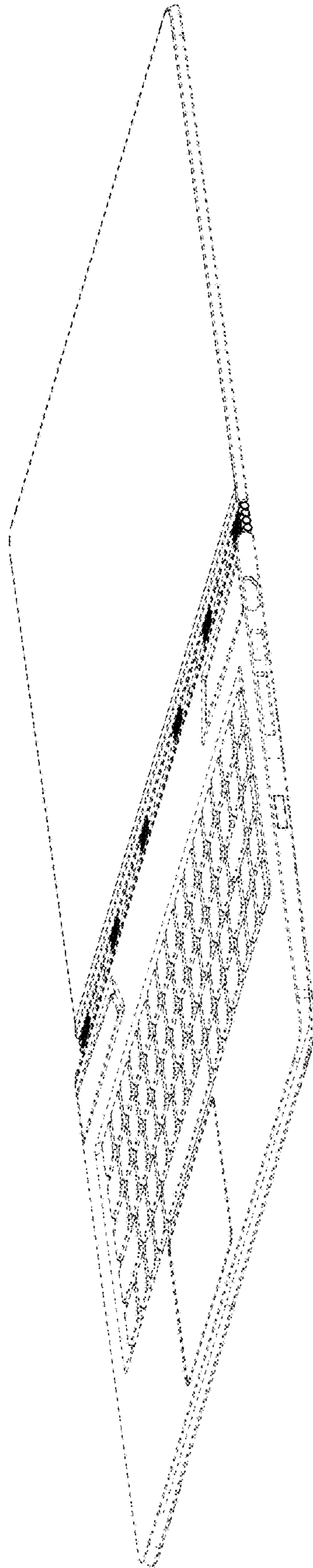

Fig.18

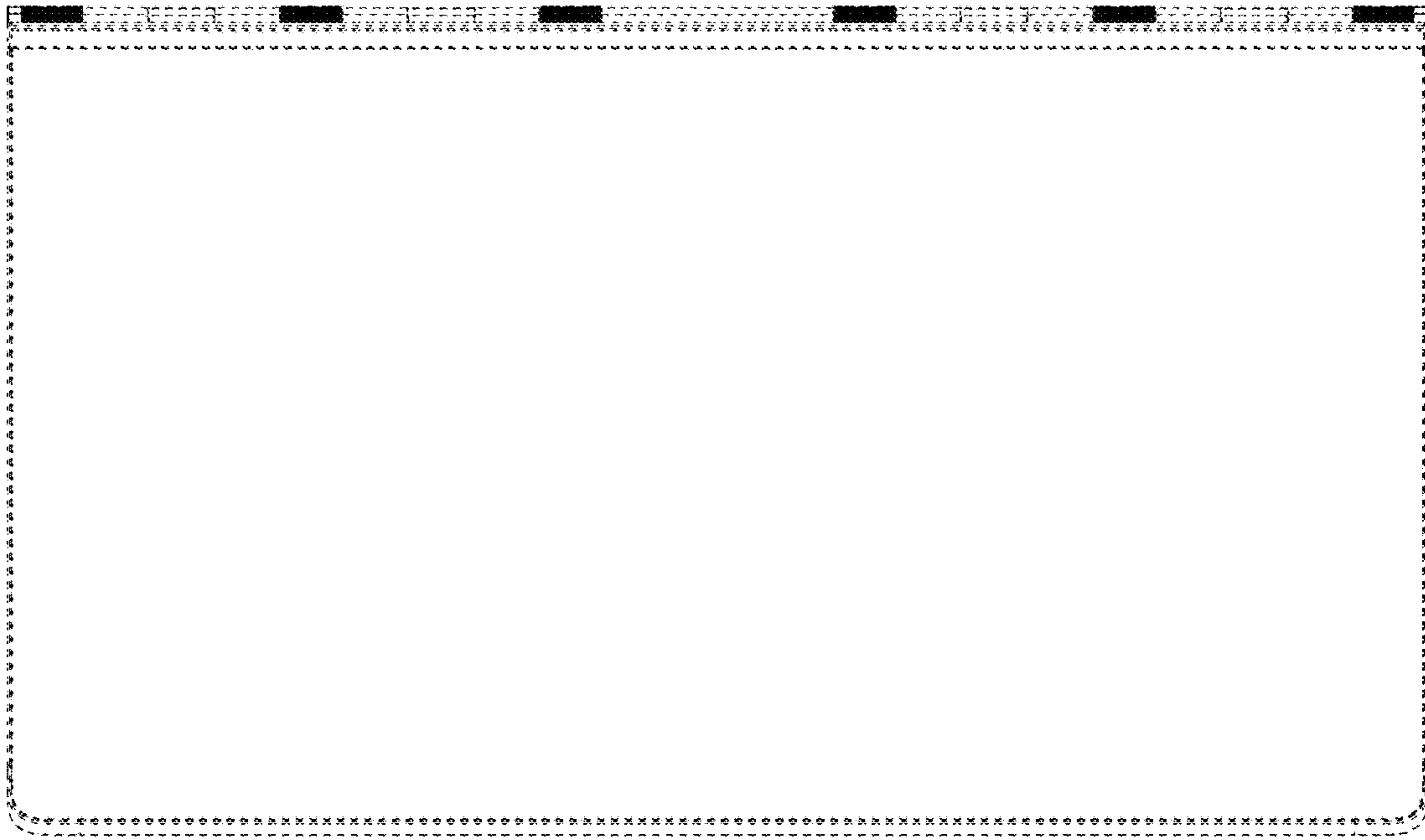

Fig.19

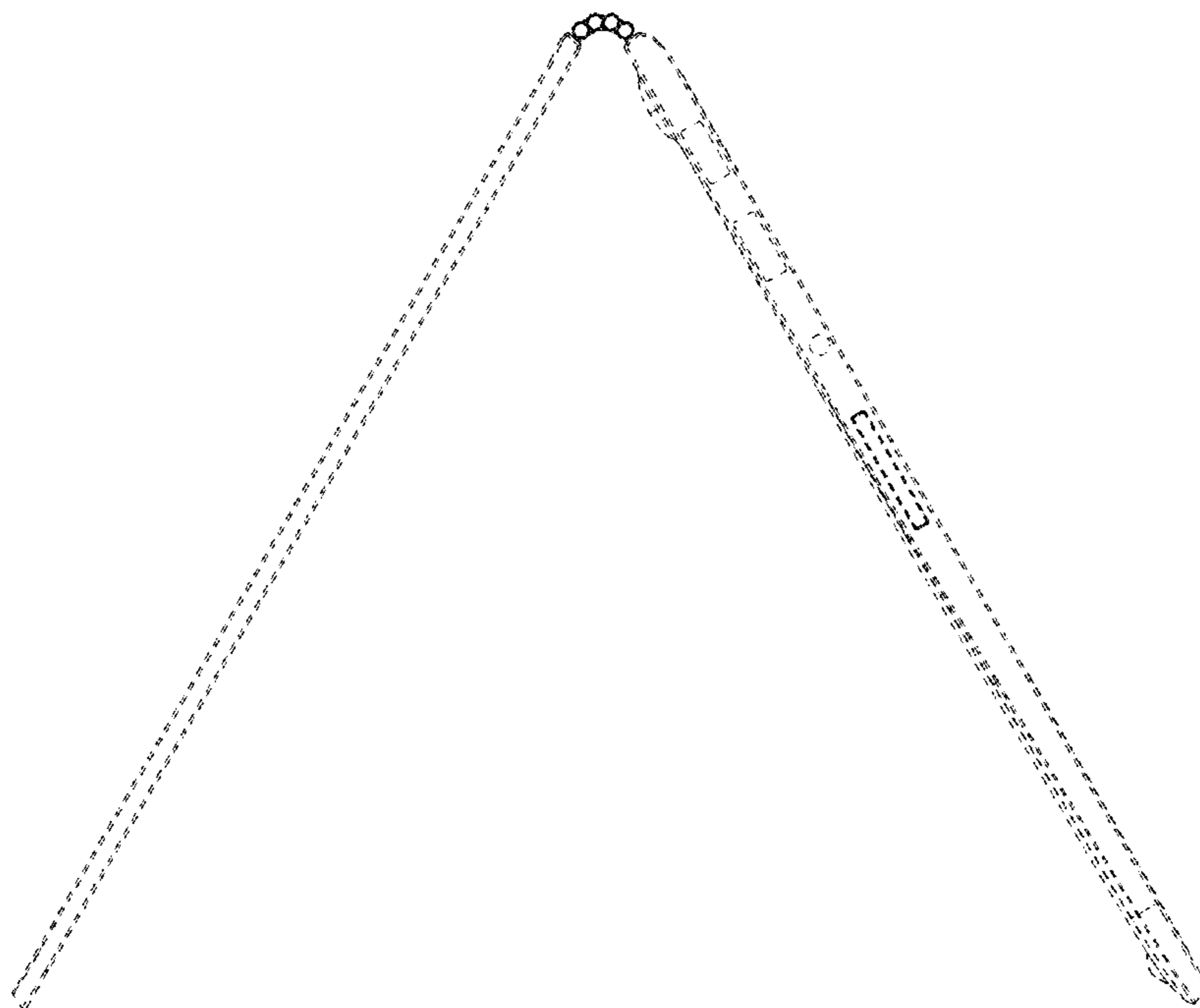

Fig.20

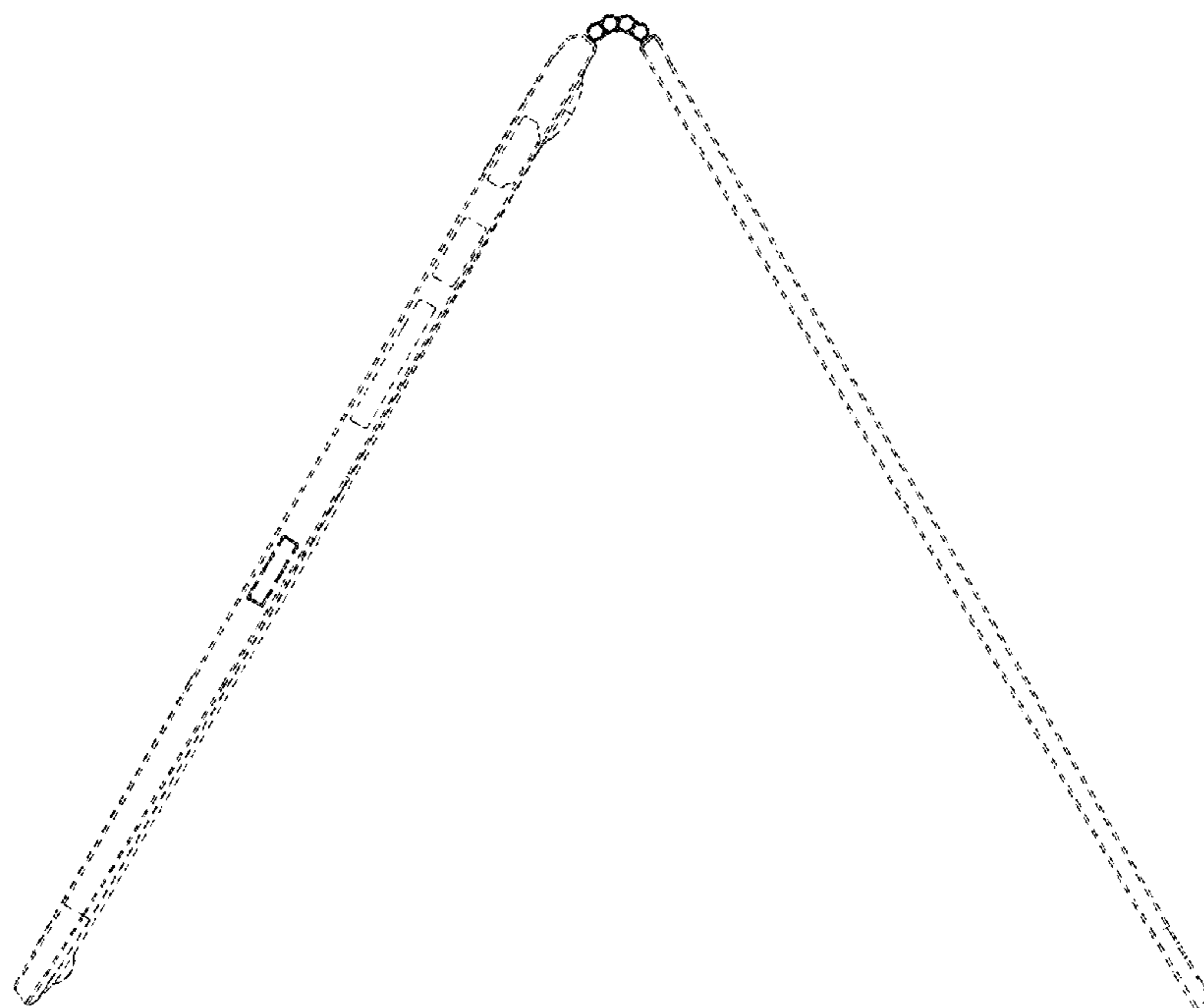

Fig.21

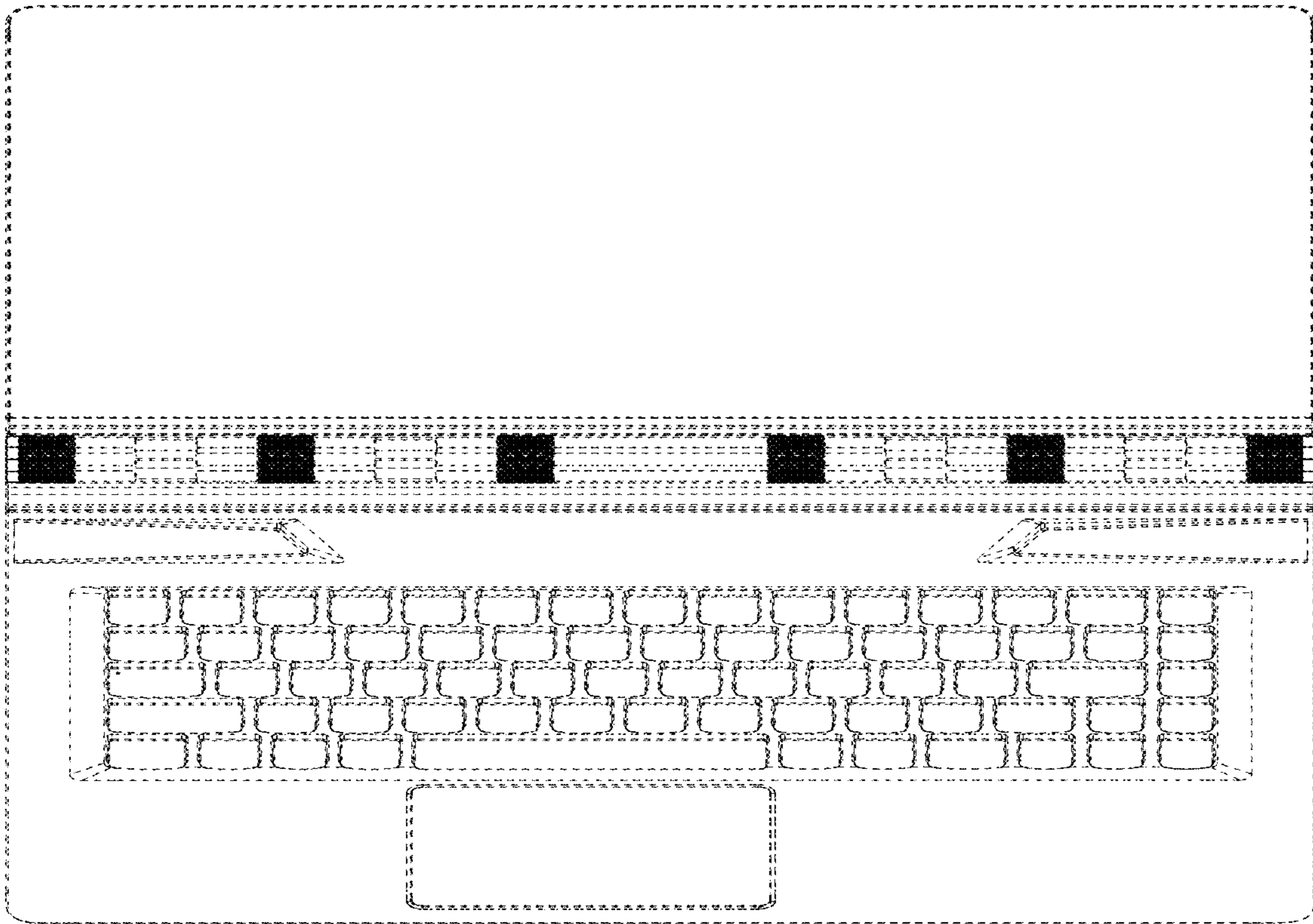

Fig.22

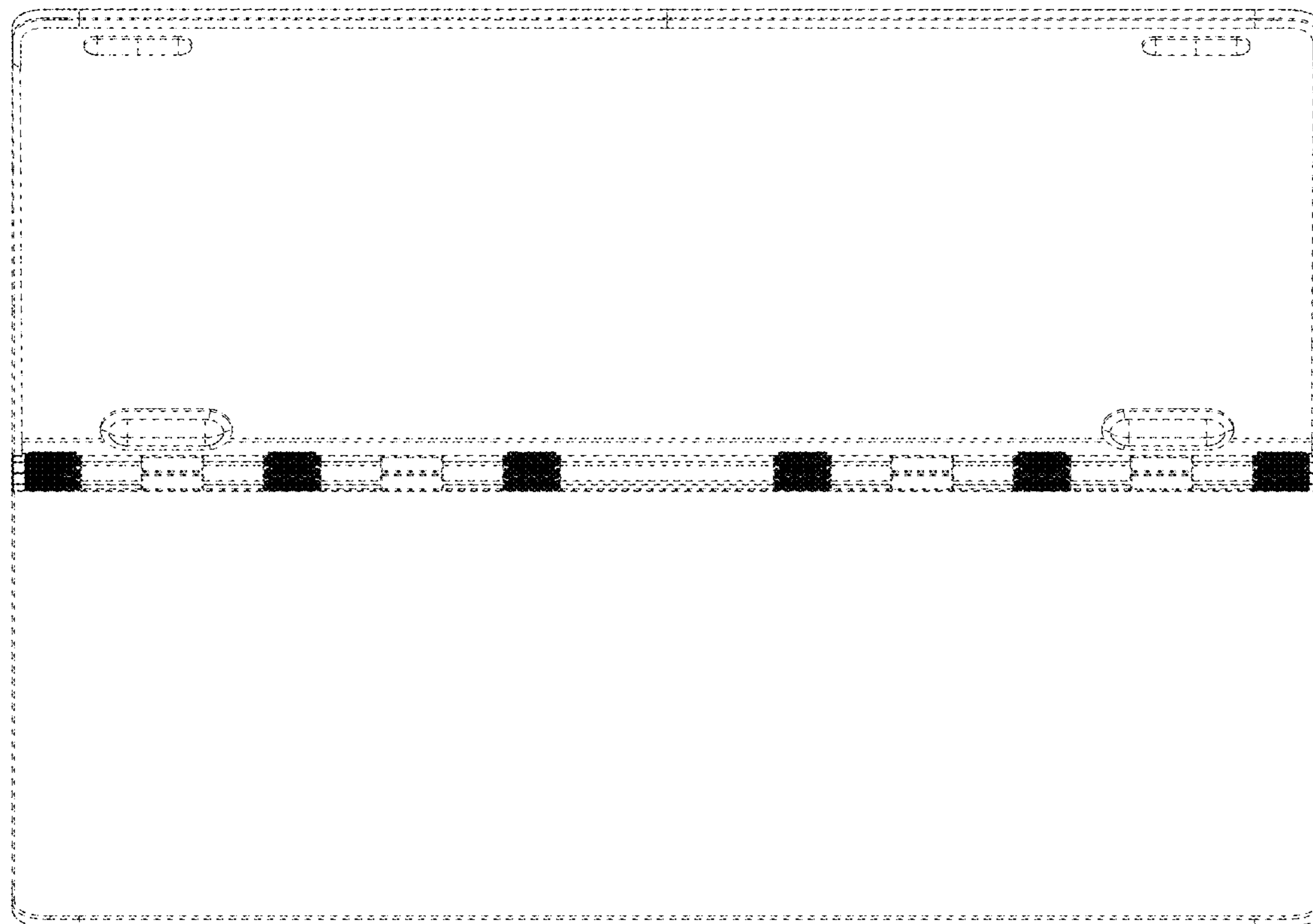

Fig.23

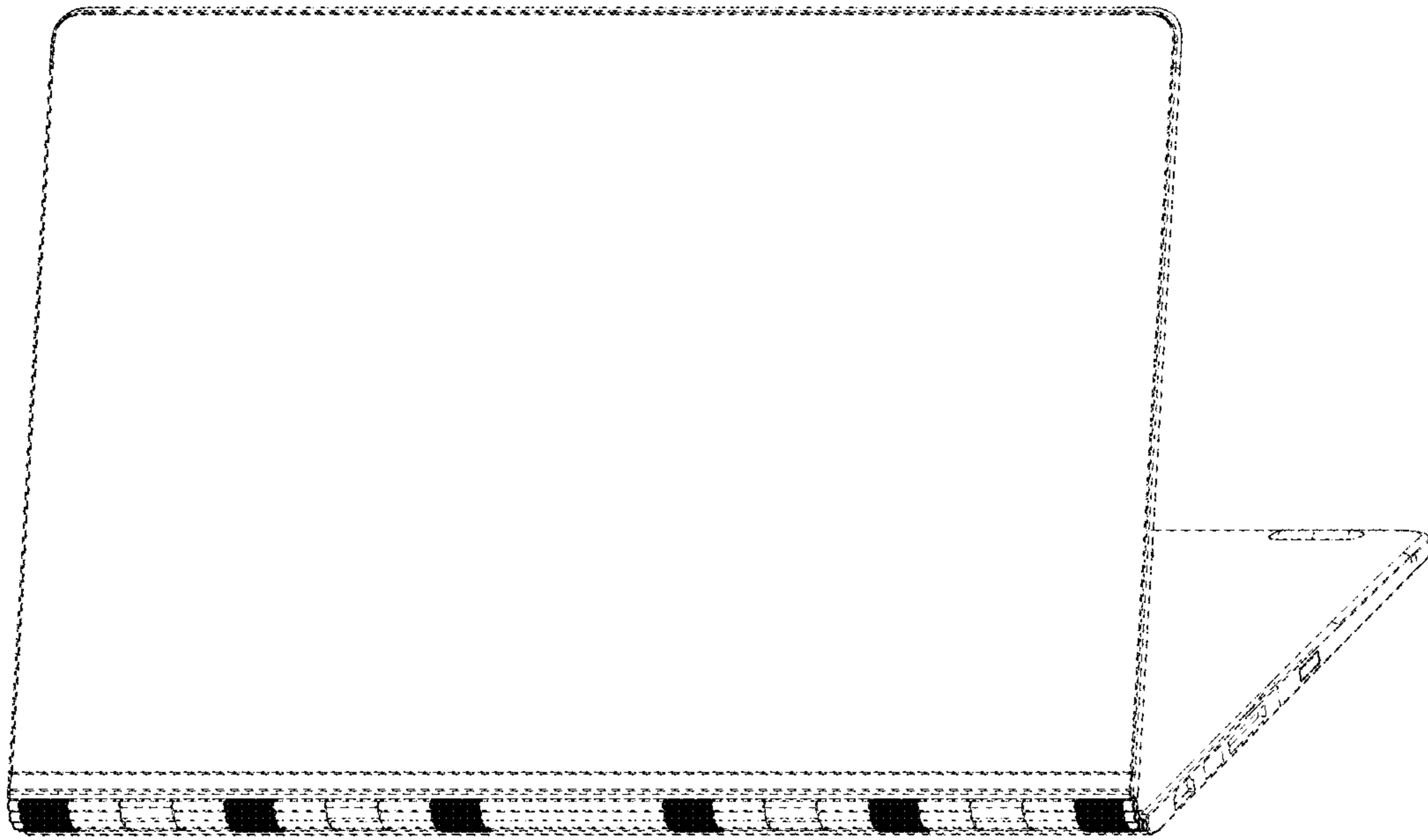

Fig.24

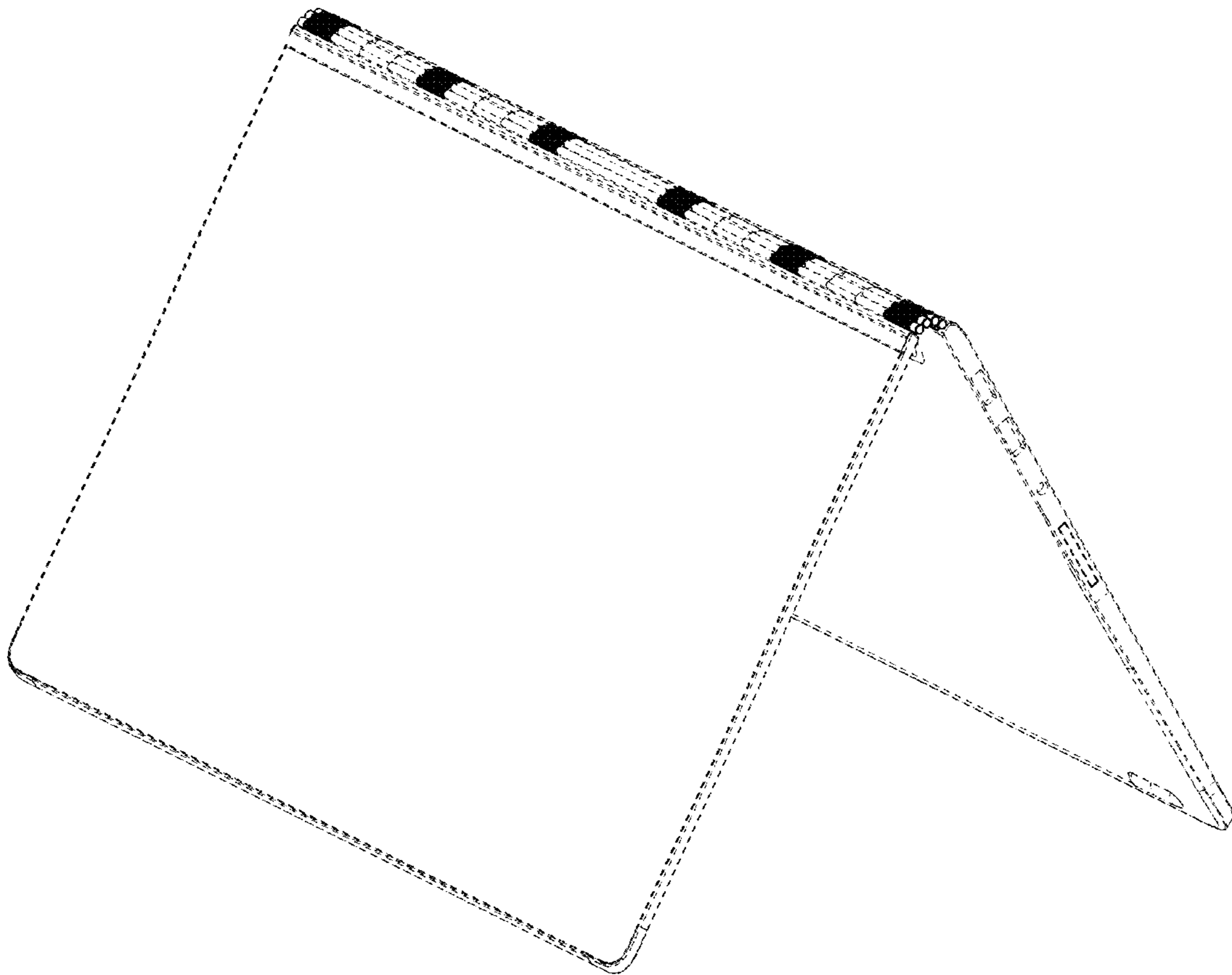

Fig.25

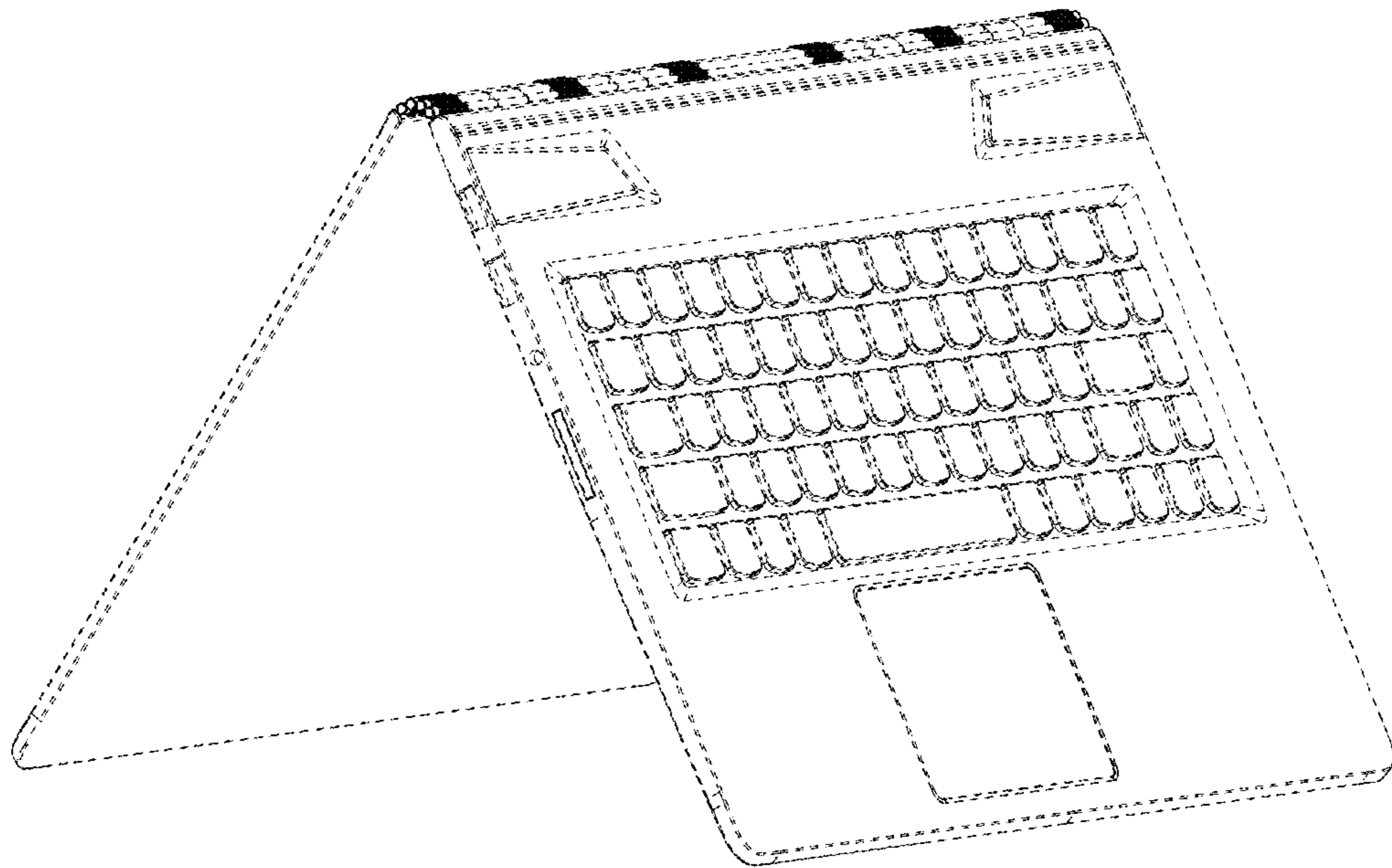

Fig.26

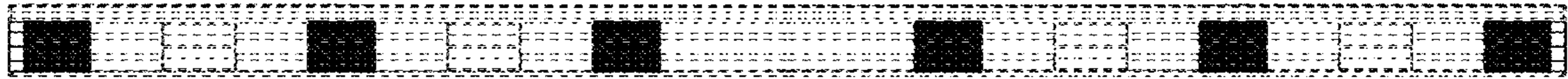

Fig.27

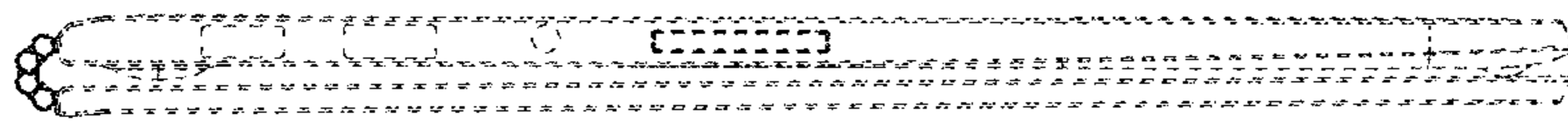

Fig.28

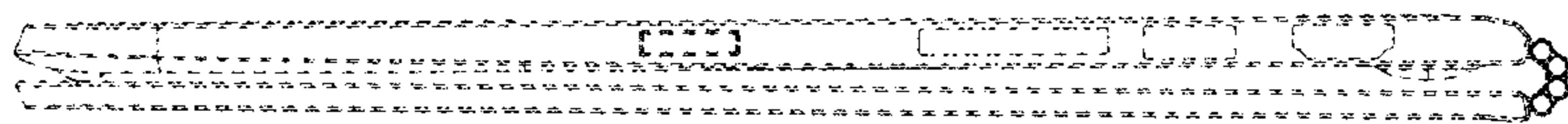

Fig.29

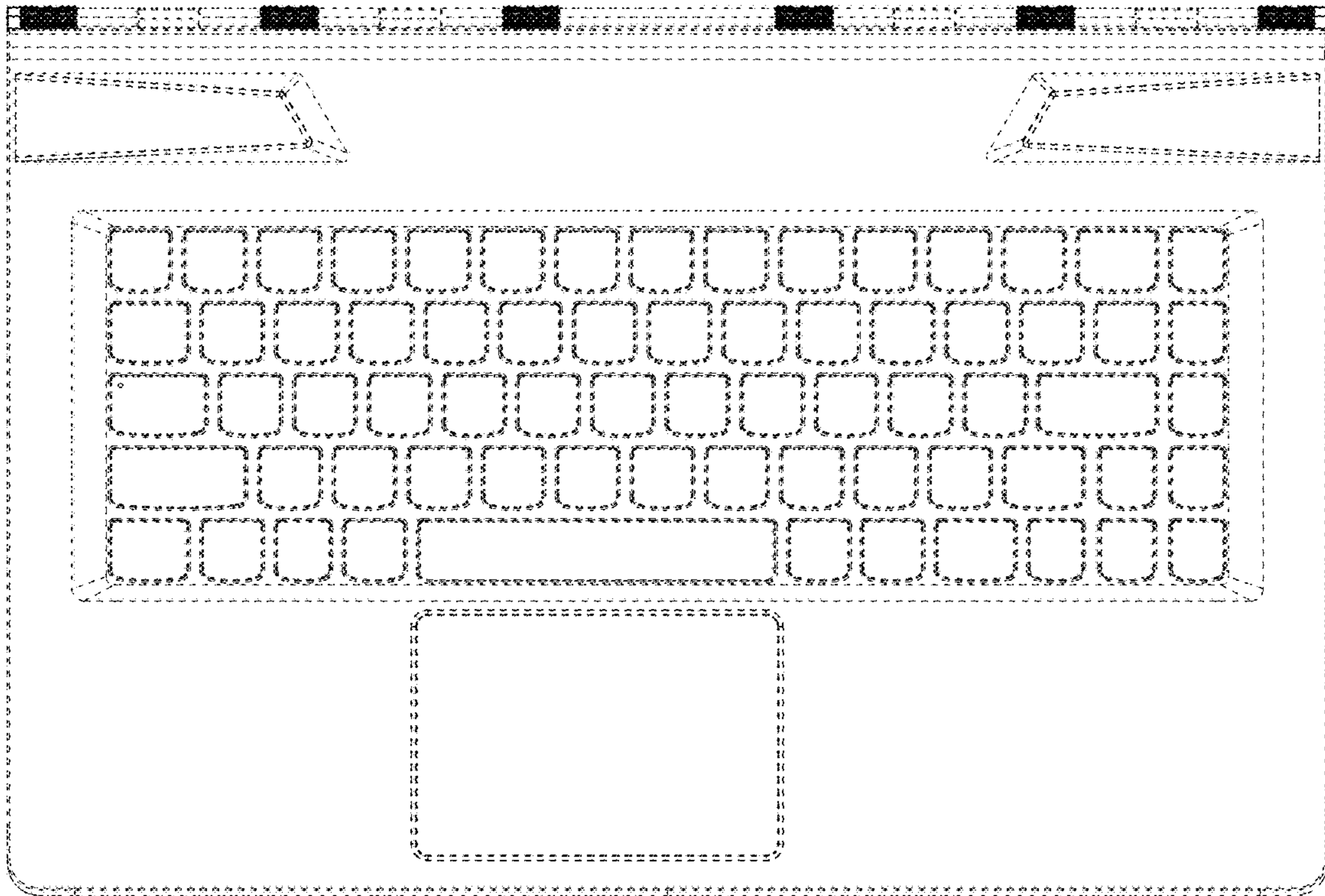

Fig.30

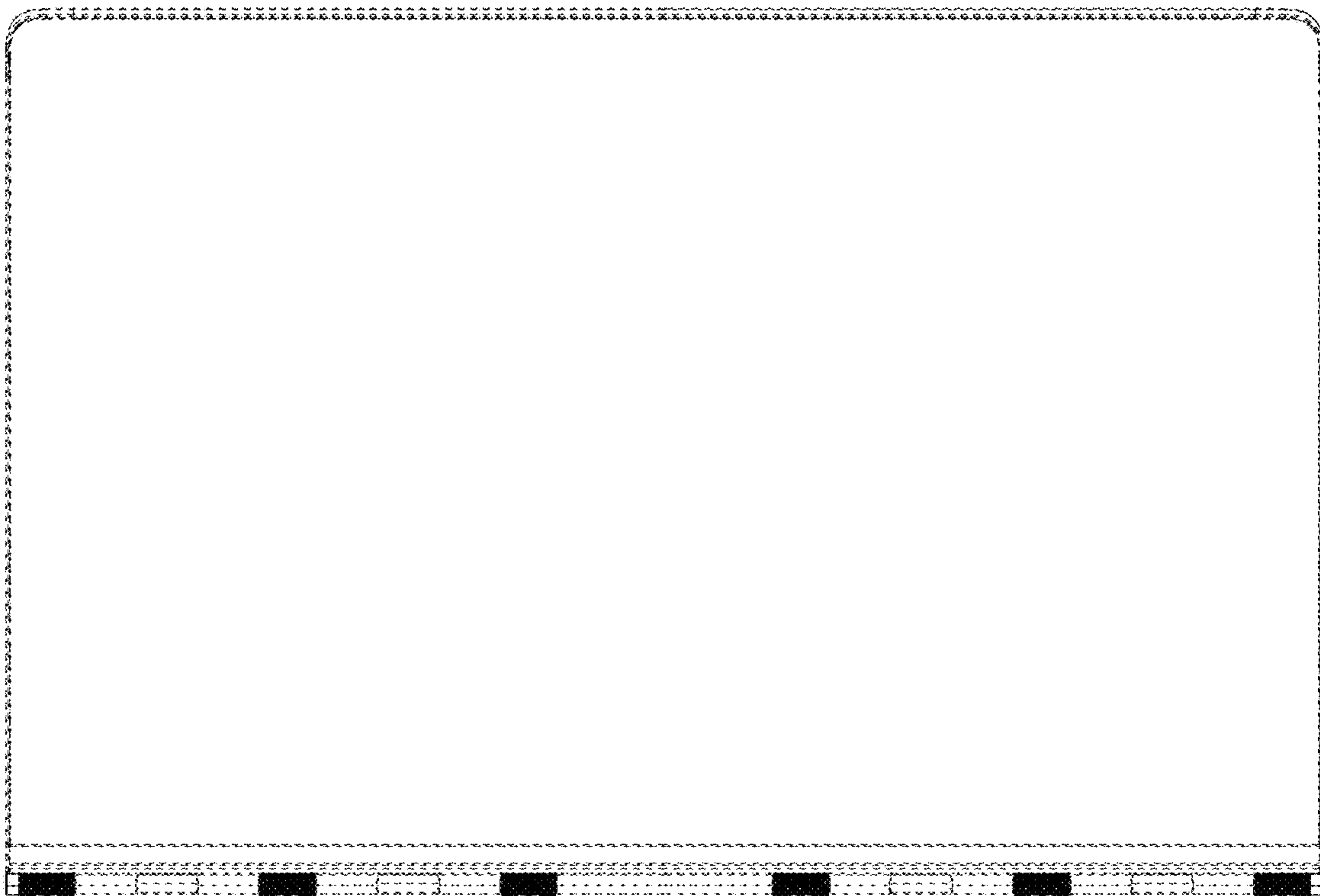

Fig.31

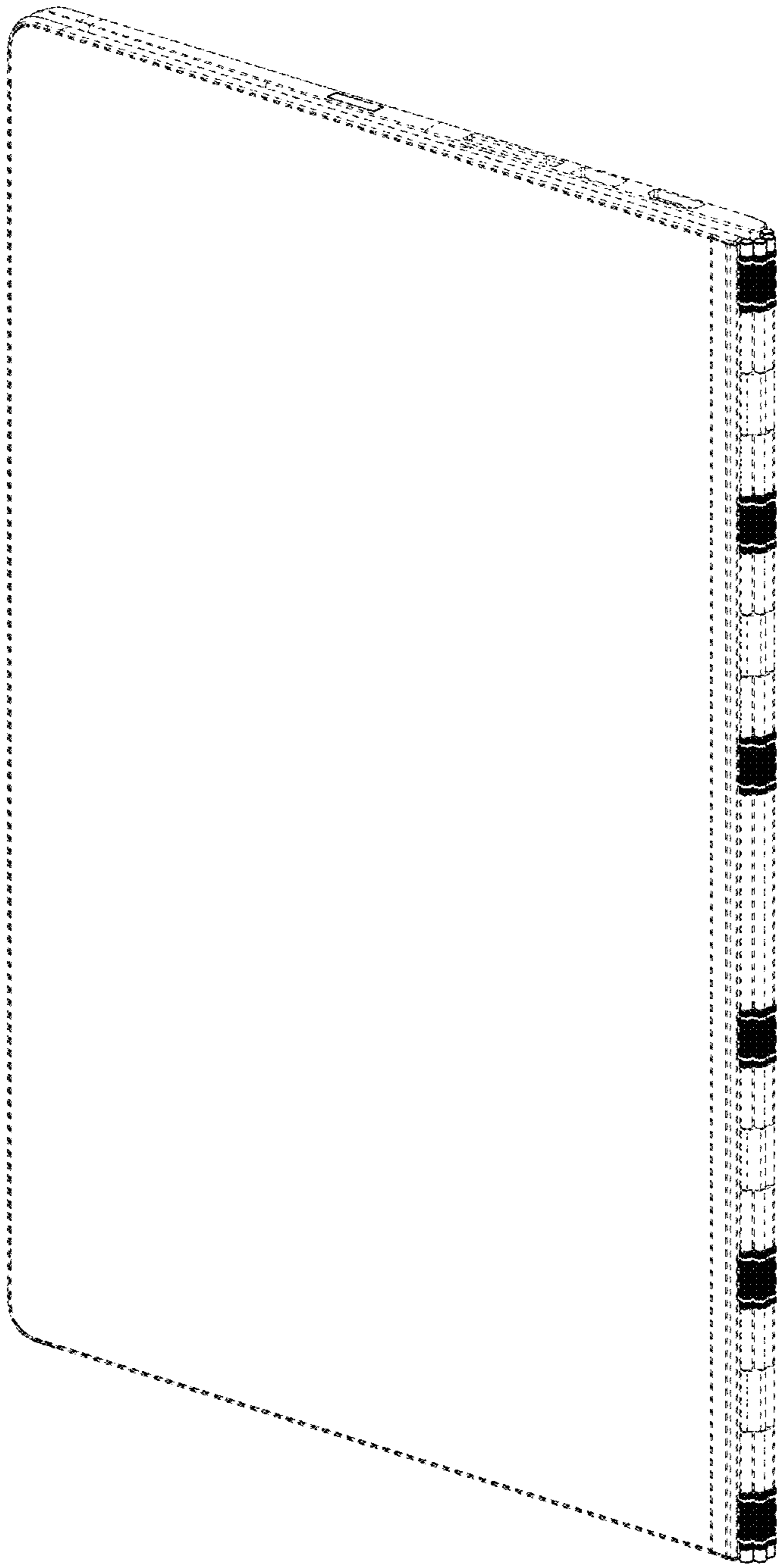

Fig.32

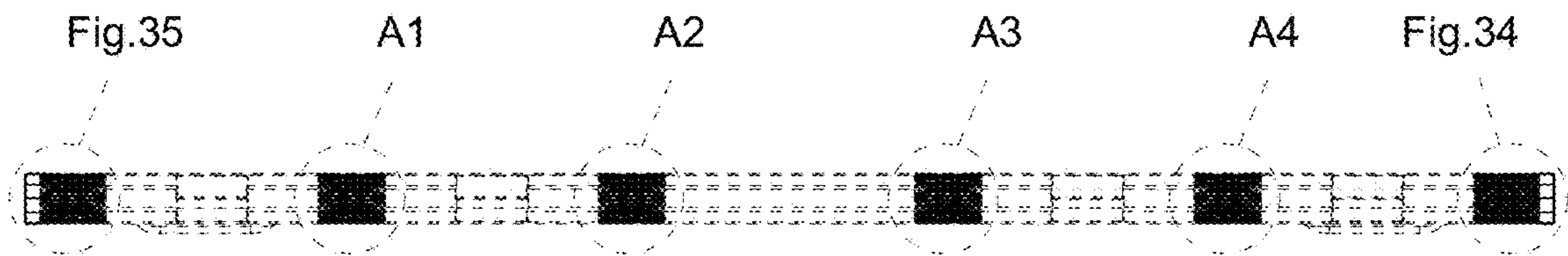

Fig. 33

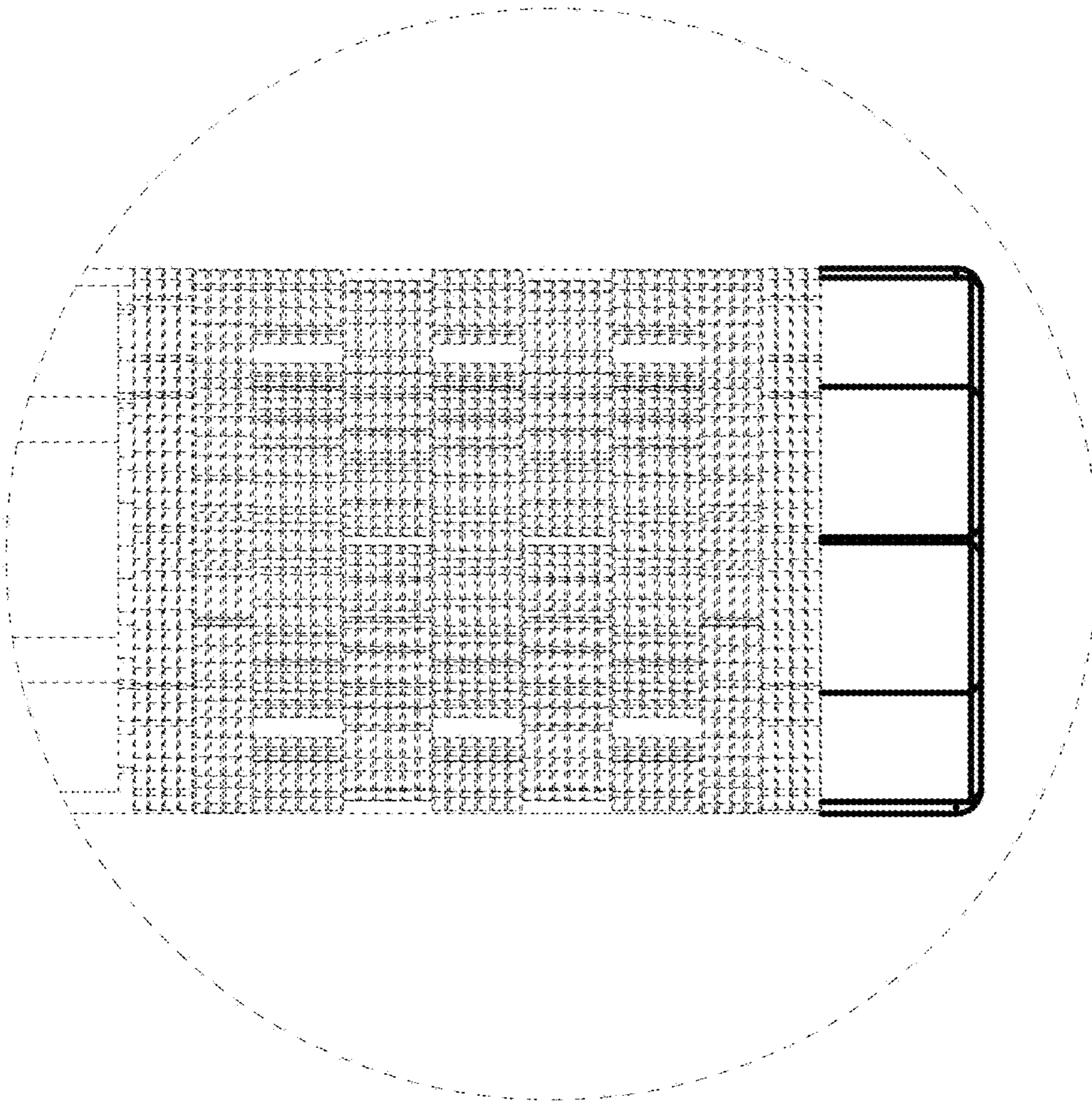

Fig. 34

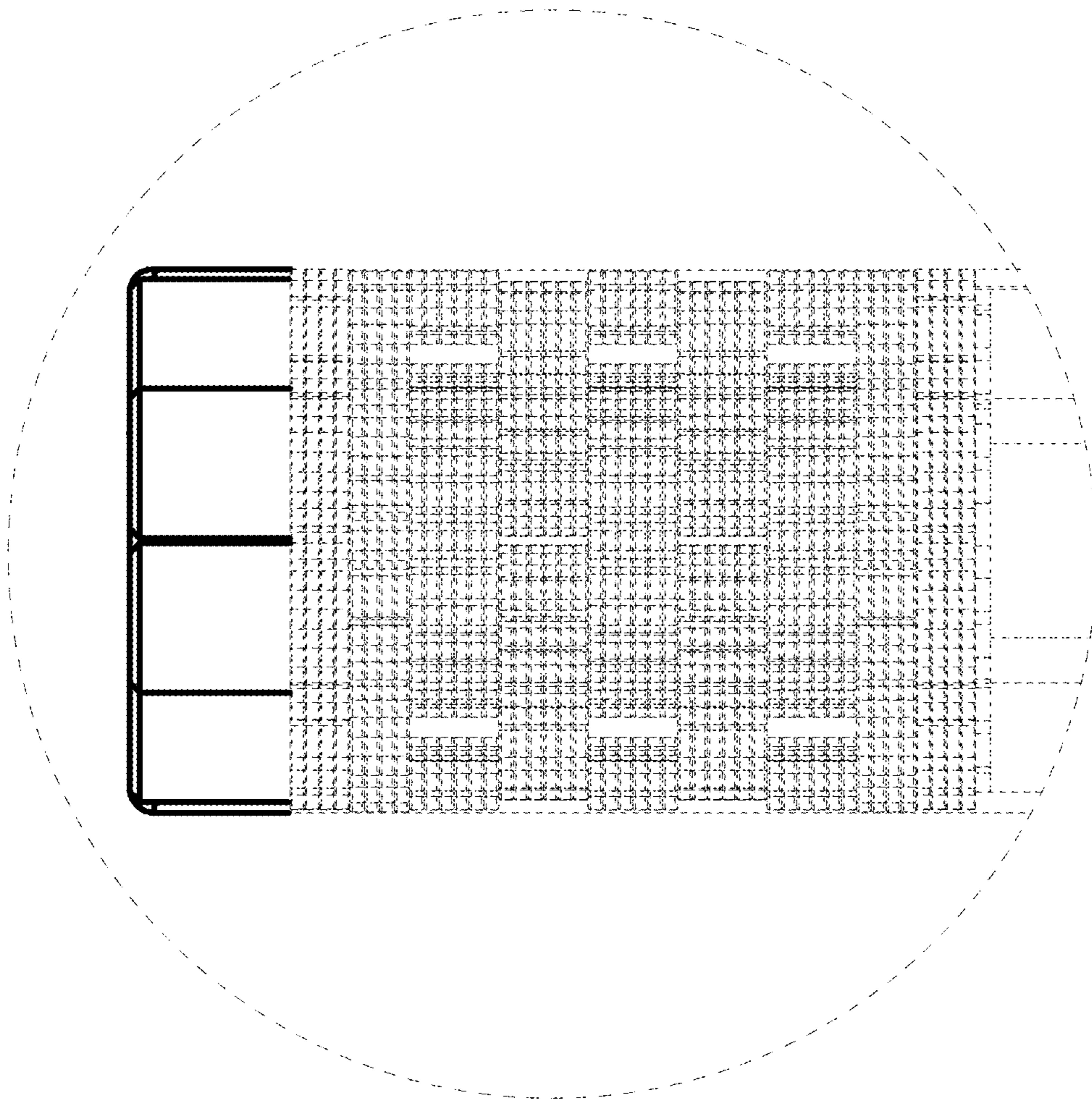

Fig.35