



US00D807339S

(12) **United States Design Patent**
Lan

(10) **Patent No.:** **US D807,339 S**
(45) **Date of Patent:** **** Jan. 9, 2018**

(54) **MOUNT FOR A CAR VENT**
(71) Applicant: **Ping Zhang**
(72) Inventor: **Changwen Lan**, Dongguan (CN)
(73) Assignee: **Ping Zhang**, Bradfordwoods, PA (US)
(*) Notice: Patent file contains an affidavit/declaration under 37 CFR 1.130(b).

(**) Term: **15 Years**

(21) Appl. No.: **29/543,774**

(22) Filed: **Oct. 28, 2015**

(51) **LOC (11) Cl.** **14-03**

(52) **U.S. Cl.**
USPC **D14/253**

(58) **Field of Classification Search**
USPC D14/251–253, 447, 451, 452, 440, 434, D14/458, 432, 439, 457, 460, 238.1, 140, D14/142, 149, 217, 148, 140.8, 140.11, D14/209.1, 151, 140.9, 250, 238; D13/107, 108; D12/415, 223, 114, 420, D12/417, 407, 177; D3/218; D16/242–245, 250, 237, 203, 214, 219; D8/349, 363; D6/675, 672, 673, 675.4, D6/553, 676, 310, 406.3, 406.4, 406.5, D6/406.6, 407, 567, 300, 682.3; 248/459, 248/460; 224/483
CPC B60R 2011/0008; B60R 11/02; B60R 11/0241; B60R 11/0258; B60R 11/0252; B60R 2011/0294; F16M 11/00; F16M 11/04; F16M 11/041; F16M 11/02; F16M 11/06; F16M 13/00; H04M 1/02; H04M 1/04; H04M 1/11; H04M 1/12; A47F 7/022; B62J 11/00; H05K 7/00; G03B 17/56

See application file for complete search history.

(56) **References Cited**

U.S. PATENT DOCUMENTS

6,446,922 B2 * 9/2002 Irie B62J 99/00 248/214
D518,029 S * 3/2006 Tsang D14/216

D709,066 S * 7/2014 Byun D14/253
D748,615 S * 2/2016 Lee D14/251
D765,549 S * 9/2016 Khodapanah D12/114
D769,234 S * 10/2016 Rami D14/253
D769,859 S * 10/2016 Herbst D14/253
D778,713 S * 2/2017 McSweyn D12/415
D778,714 S * 2/2017 McSweyn D12/415

(Continued)

OTHER PUBLICATIONS

Dec. 6, 2014; Amazon.com; WizGear Universal Air Vent Magnetic Car Mount Holder with Fast Swift-Snap Technology for Smartphones and Mini Tablets; https://www.amazon.com/WizGear-Universal-Swift-Snap-Technology-Smartphones/dp/B00PGJWYJ0/ref=cm_cr_arp_d_product_top?ie=UTF8.*

(Continued)

Primary Examiner — Janice Hallmark

(74) *Attorney, Agent, or Firm* — Na Xu; IPro, PLLC

(57) **CLAIM**

The ornamental design for a mount for a car vent, as shown and described.

DESCRIPTION

FIG. 1 is a front perspective view of a mount for a car vent showing our new design;
FIG. 2 is a front elevation view thereof; a rear elevation view is a mirror image of the front elevation view and is not separately depicted.
FIG. 3 is a left elevation view thereof; a right elevation view is a mirror image of the left elevation view and is not separately depicted.
FIG. 4 is a top plan view thereof; and,
FIG. 5 is a bottom plan view thereof.
The broken lines in the drawings depict parts of mount for a car vent that form no part of the claimed design.

1 Claim, 3 Drawing Sheets

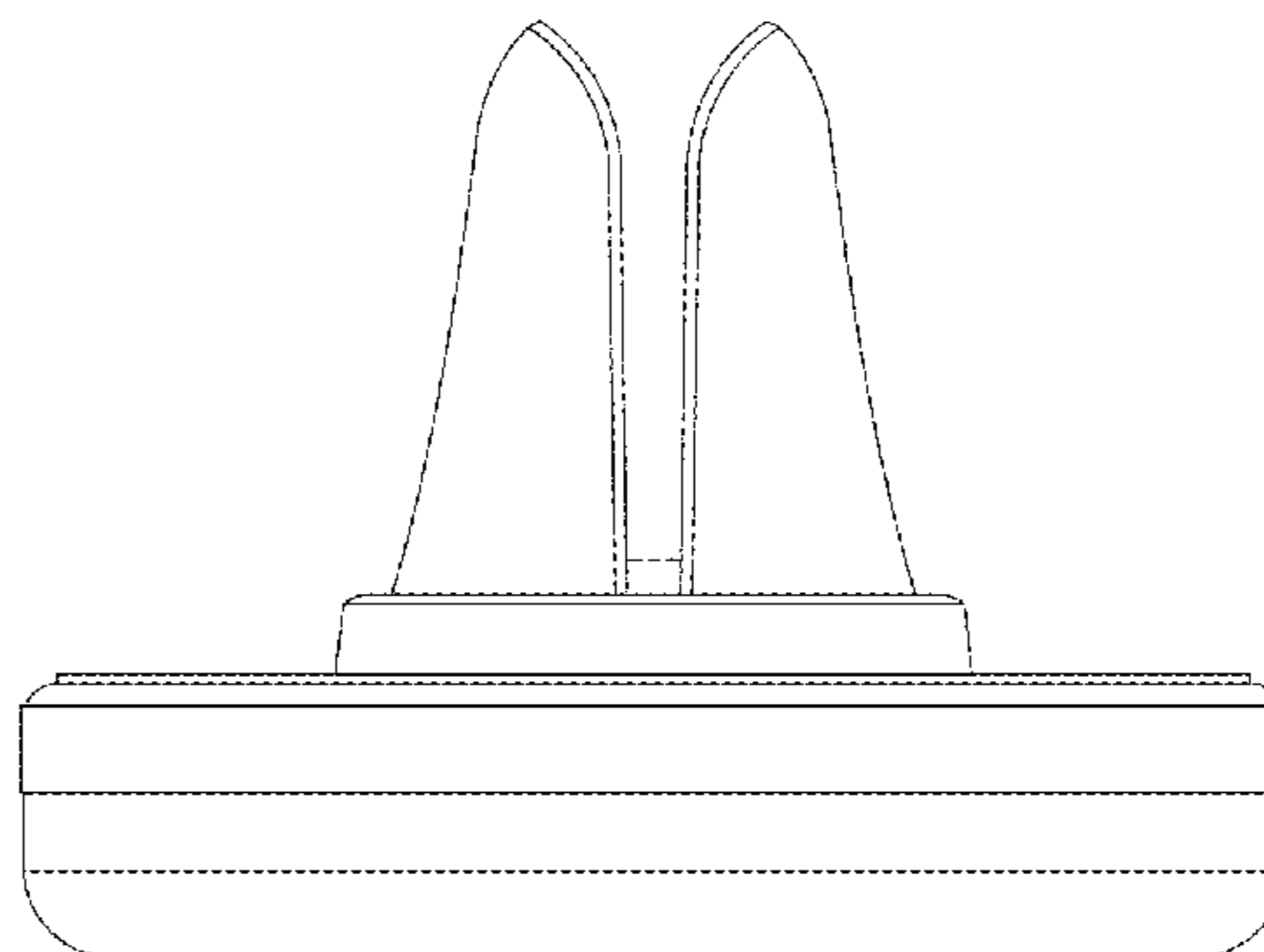
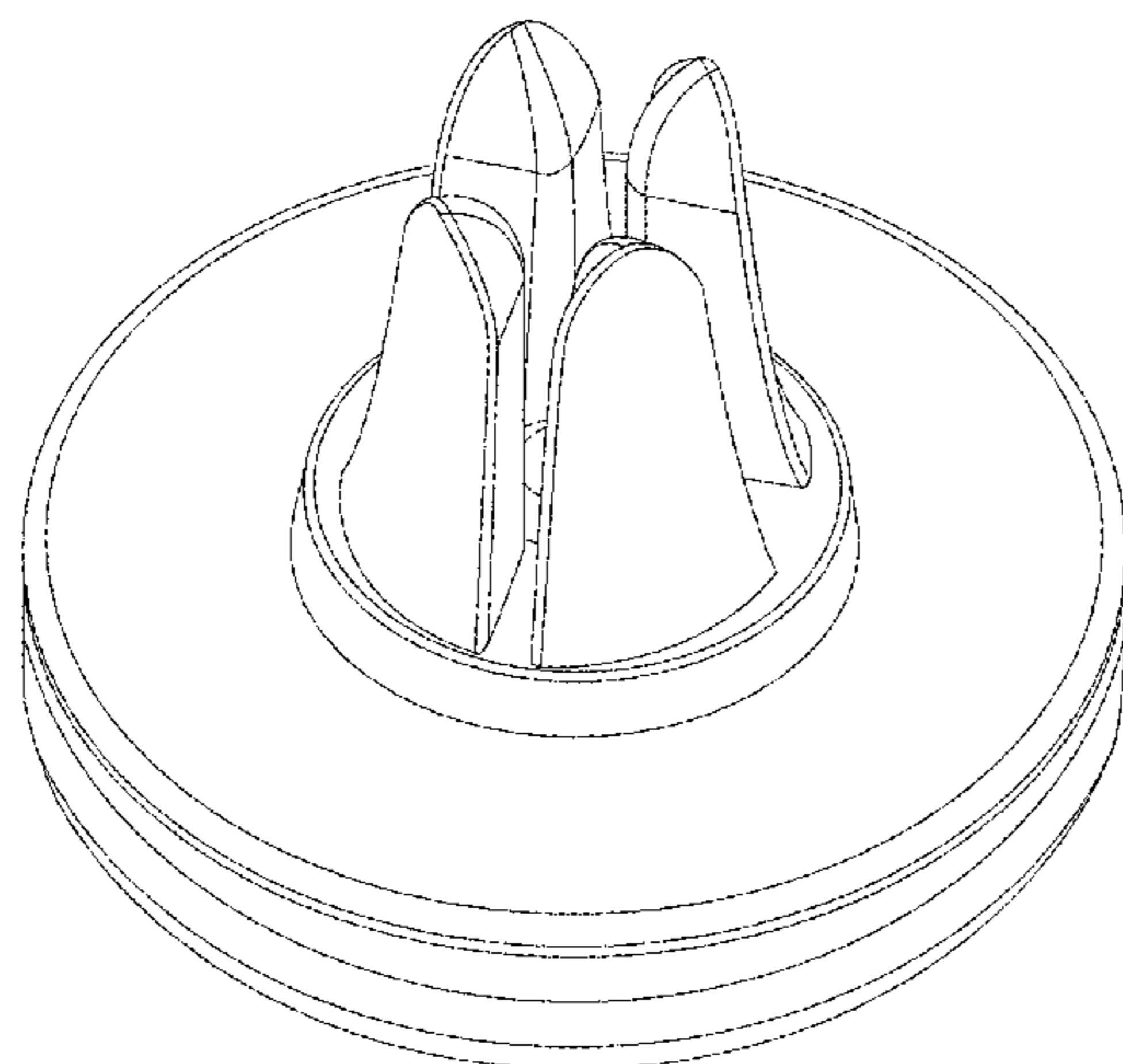

(56)

References Cited

U.S. PATENT DOCUMENTS

2011/0163143 A1* 7/2011 Zanetti B60R 11/02
224/567

OTHER PUBLICATIONS

Jun. 9, 2015; Amazon.com; Mpow Air Vent Magnetic Car Mount, Cell Phone Holder for Car, https://www.amazon.com/Mpow-Magnetic-Compatible-Android-Smartphones/dp/B00YE6D718/ref=cm_cr_ar_p_d_product_top?ie=UTF8.*

Jan. 20, 2015; Amazon.com, TechMatte MagGrip Air Vent Magnetic Universal Car Mount Holder for Smartphones, https://www.amazon.com/TechMatte-Magnetic-Universal-Smartphones-including/dp/B00OJE1SG8/ref=cm_cr_ar_p_d_product_top?ie=UTF8.*

Aug. 19, 2015; Amazon.com, Spigen Kuel A200 Car Mount Magnetic Air Vent Phone Holder, https://www.amazon.com/Spigen-Magnetic-Holder-Compatible-iPhone/dp/B0109JIQ0W/ref=cm_cr_ar_p_d_product_top?ie=UTF8.*

* cited by examiner

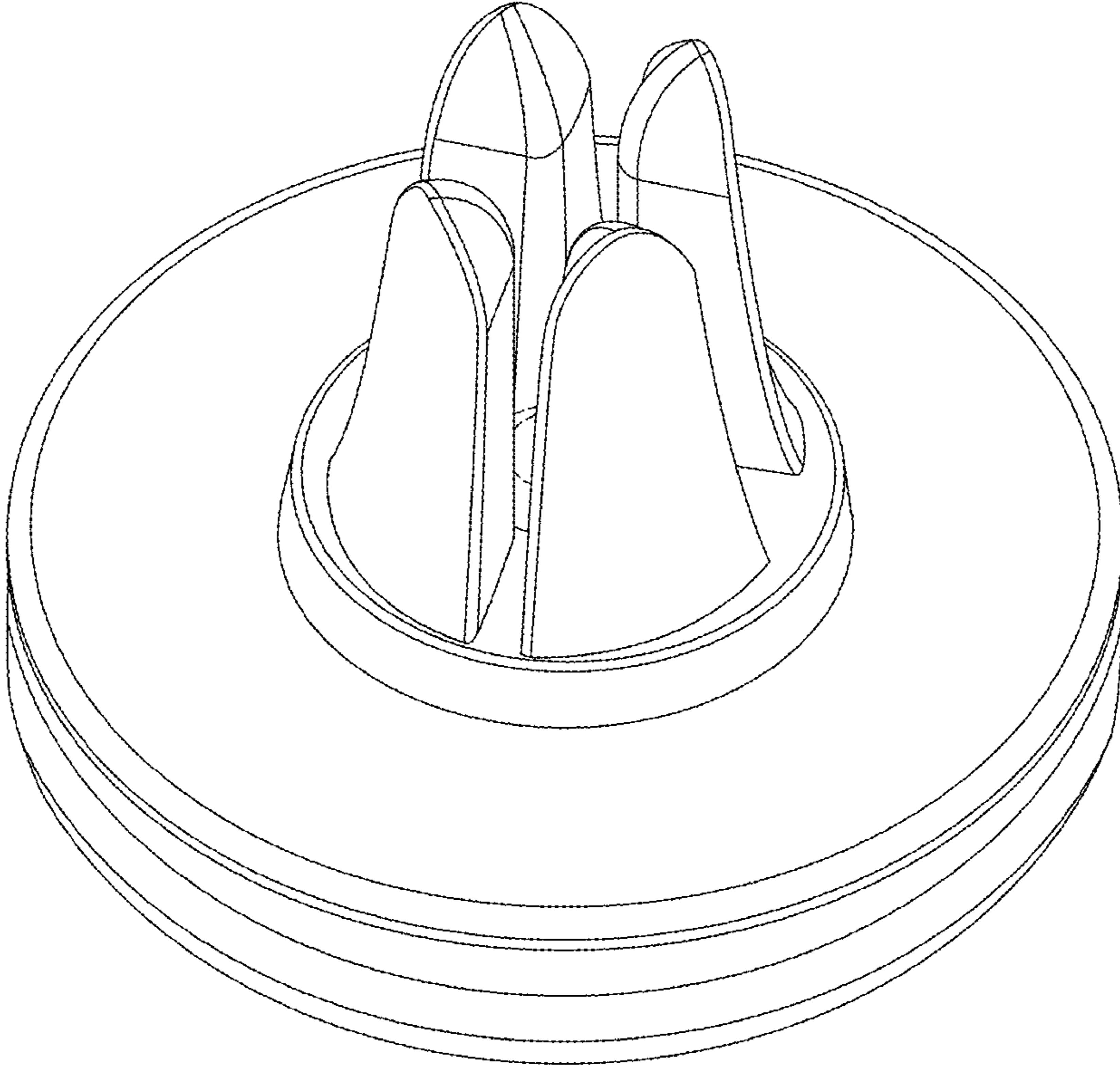

FIG. 1

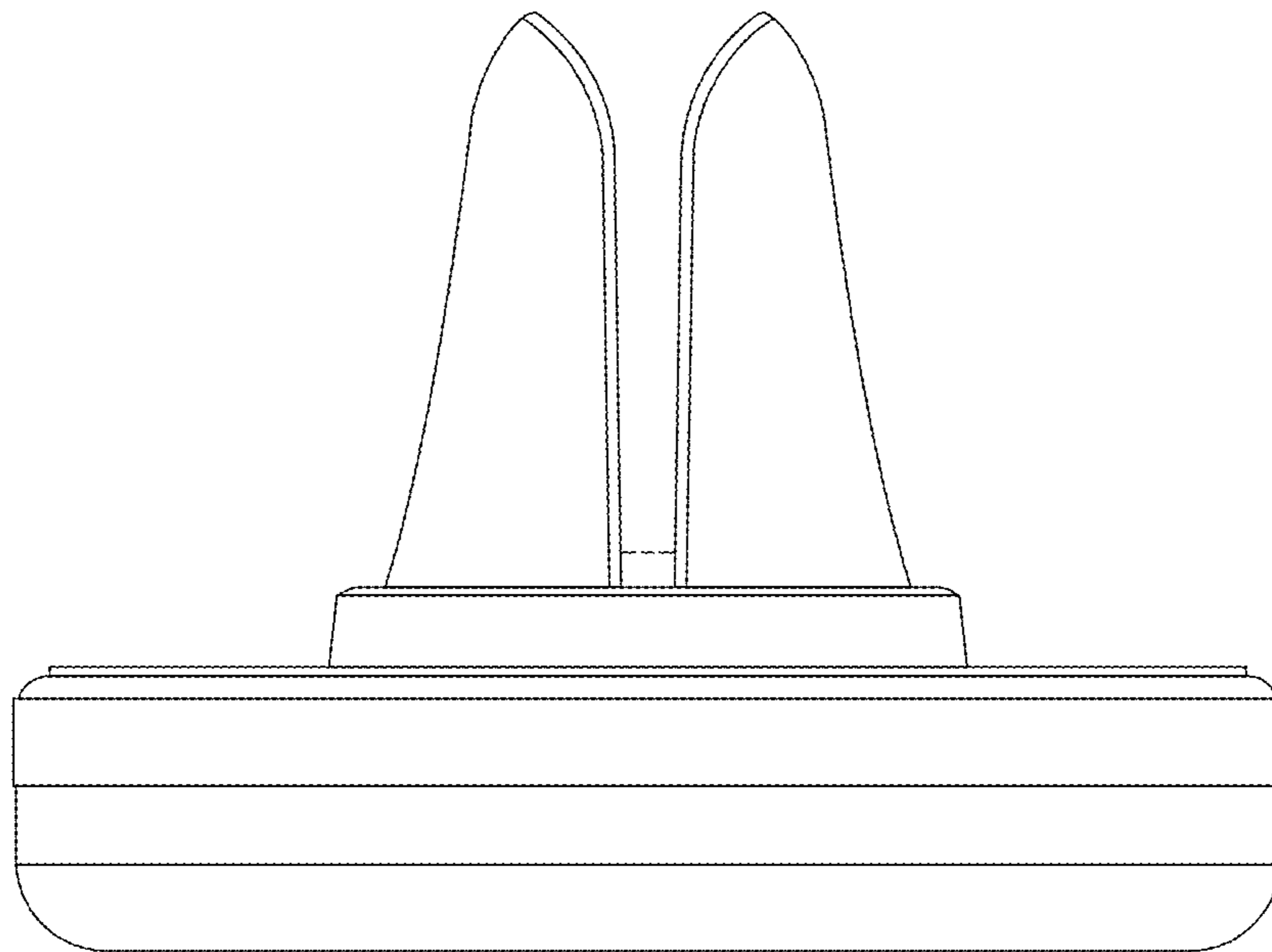

FIG. 2

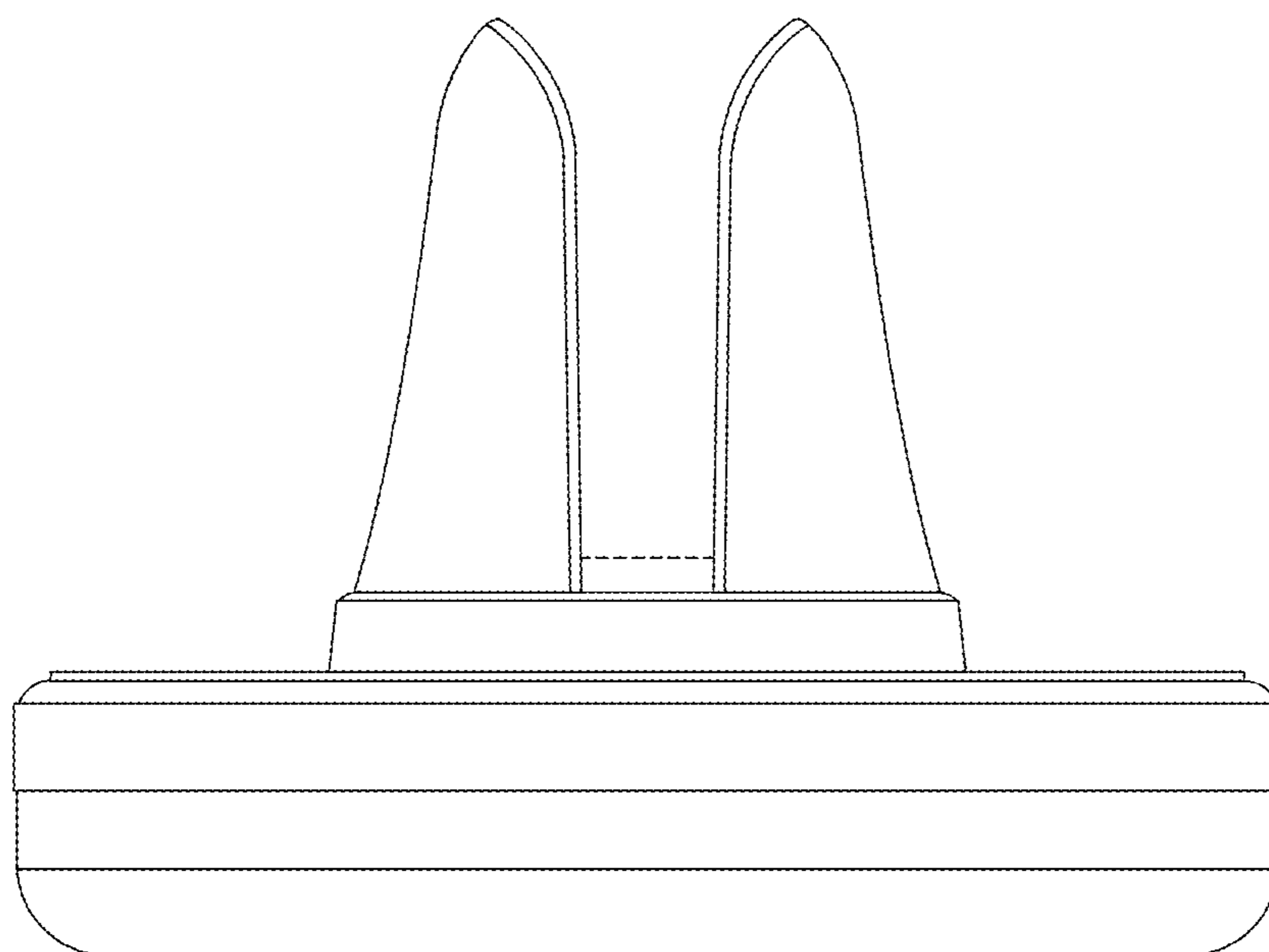

FIG. 3

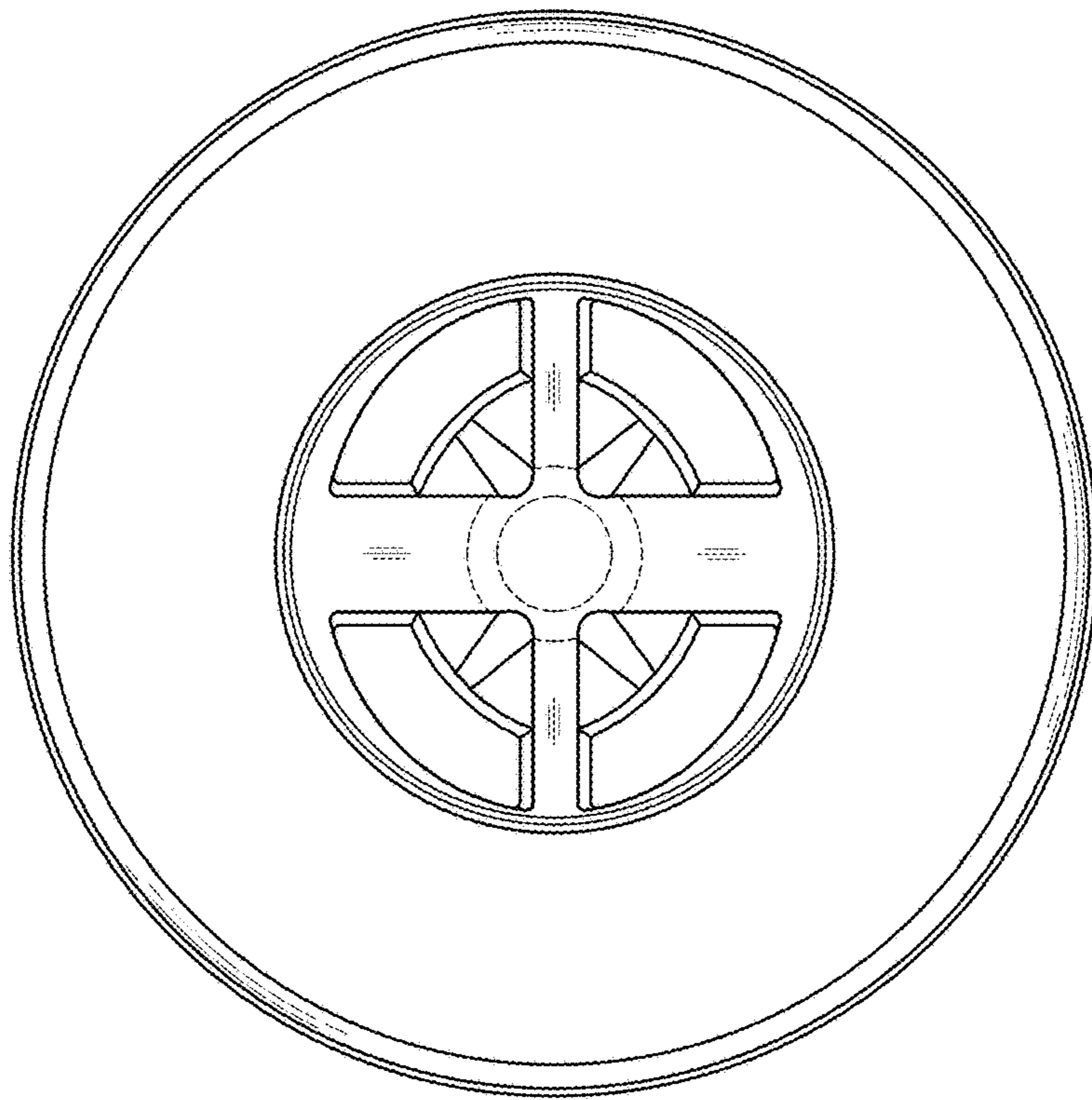

FIG. 4

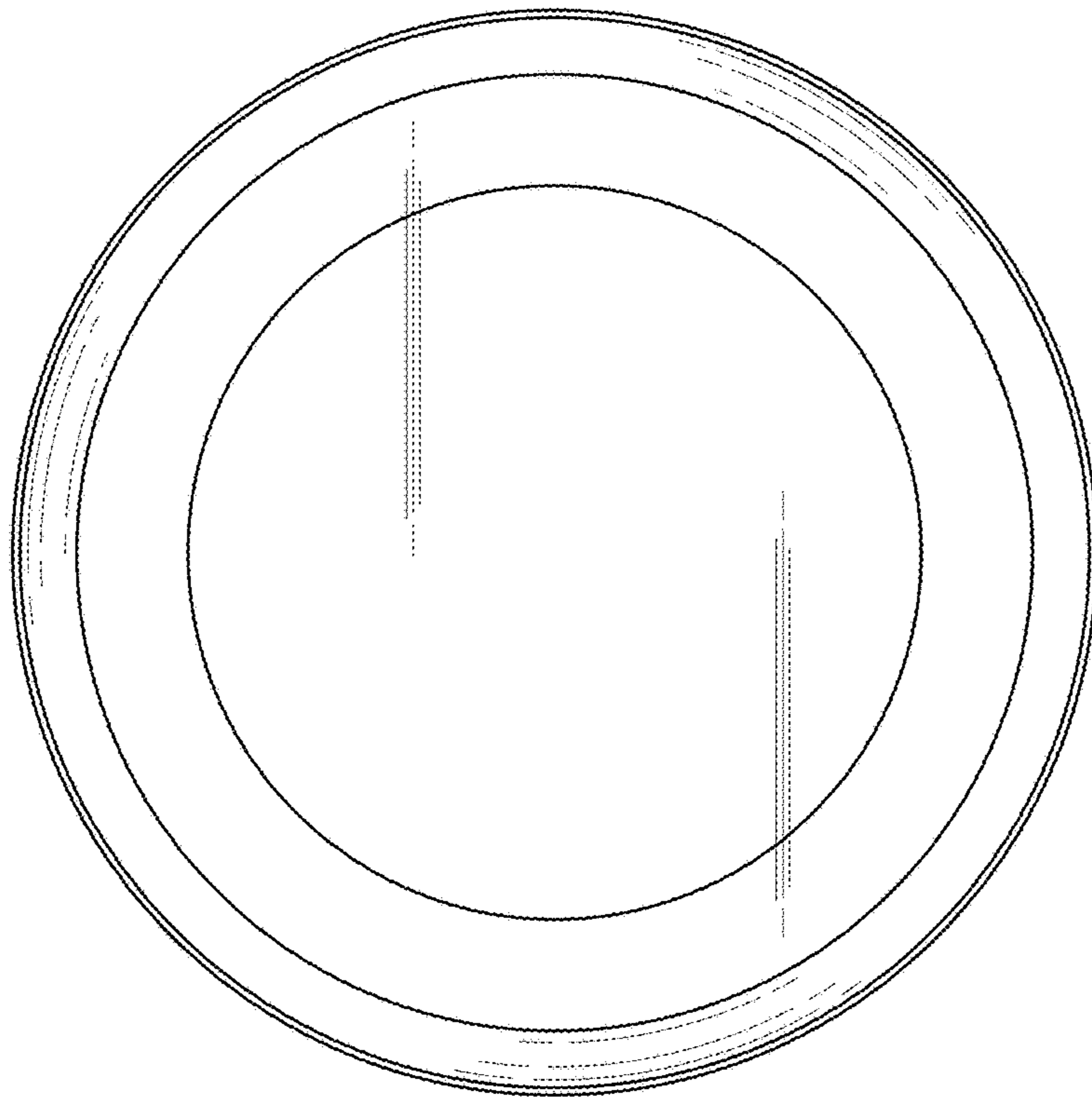

FIG. 5