



US00D807338S

(12) **United States Design Patent** (10) **Patent No.:** **US D807,338 S**
Kim (45) **Date of Patent:** **** Jan. 9, 2018**

(54) **CASE FOR ELECTRONIC DEVICE**

(71) Applicant: **Dae-Young Kim**, Seoul (KR)

(72) Inventor: **Dae-Young Kim**, Seoul (KR)

(73) Assignee: **SPIGEN KOREA CO., LTD.**,
Geumcheon-Gu, Seoul (KR)

(**) Term: **15 Years**

(21) Appl. No.: **29/593,707**

(22) Filed: **Feb. 10, 2017**

Related U.S. Application Data

(63) Continuation of application No. 29/568,017, filed on Jun. 14, 2016, now Pat. No. Des. 788,760, which is a continuation of application No. 29/495,236, filed on Jun. 27, 2014, now Pat. No. Des. 771,607, application No. 29/593,707, which is a continuation of application No. 29/568,020, filed on Jun. 14, 2016, now Pat. No. Des. 791,116, application No. 29/593,707, which is a continuation of application No. 29/568,021, filed on Jun. 14, 2016, now Pat. No. Des. 786,233.

(51) **LOC (11) Cl.** **14-01**

(52) **U.S. Cl.**

USPC **D14/250**

(58) **Field of Classification Search**

USPC D14/250-253, 440, 203.3-203.7, 217,
D14/496, 248, 238.1, 240, 447, 230, 247,
D14/341, 345, 346, 439; D3/201, 218,
D3/269, 301, 273, 303; D13/103,
D13/107-108; 220/4.02; 248/309.1;
361/679.56; 379/426, 433.11, 455;
455/575.1, 575.8; 190/100; 206/305,
206/320

CPC . A45C 2011/002; A45C 11/00; A45C 13/002;
A45C 2011/003; H04M 1/0283; H04M
1/0202; H04M 1/185; H04B 1/3888

See application file for complete search history.

(56) **References Cited**

U.S. PATENT DOCUMENTS

D657,782 S 4/2012 Biller
D689,852 S 9/2013 Azoulay
D703,652 S * 4/2014 Melanson D14/250
D703,655 S 4/2014 Melanson
D732,498 S 6/2015 Huang
D736,205 S 8/2015 Park
D739,391 S 9/2015 Chen
D741,279 S 10/2015 Tai

(Continued)

OTHER PUBLICATIONS

“iPhone SE 5S 5 Tough Case, Fone-Stuff®—2 Layer Armor Shell Hardback Cover in White (Includes Screen Protector)”, https://www.amazon.co.uk/iPhone-Touch-Case-Fone-Stuff®-Protector/dp/B00J7Y547O/ref=sr_1_4; available online Mar. 24, 2014.

Primary Examiner — Sandra Snapp

Assistant Examiner — Holly E Thurman

(74) *Attorney, Agent, or Firm* — Lucem, PC; Heedong Chae

(57) **CLAIM**

The ornamental design for a case for electronic device, as shown and described.

DESCRIPTION

FIG. 1 is a front perspective view of a case for electronic device showing my new design;
FIG. 2 is another front perspective view thereof;
FIG. 3 is a rear perspective view thereof;
FIG. 4 is a front elevational view thereof;
FIG. 5 is a rear elevational view thereof;
FIG. 6 is a left side elevational view thereof;
FIG. 7 is a right side elevational view thereof;
FIG. 8 is a top plan view thereof; and,
FIG. 9 is a bottom plan view thereof.

The broken lines depict of unclaimed environment and form no part of the claimed design.

1 Claim, 9 Drawing Sheets

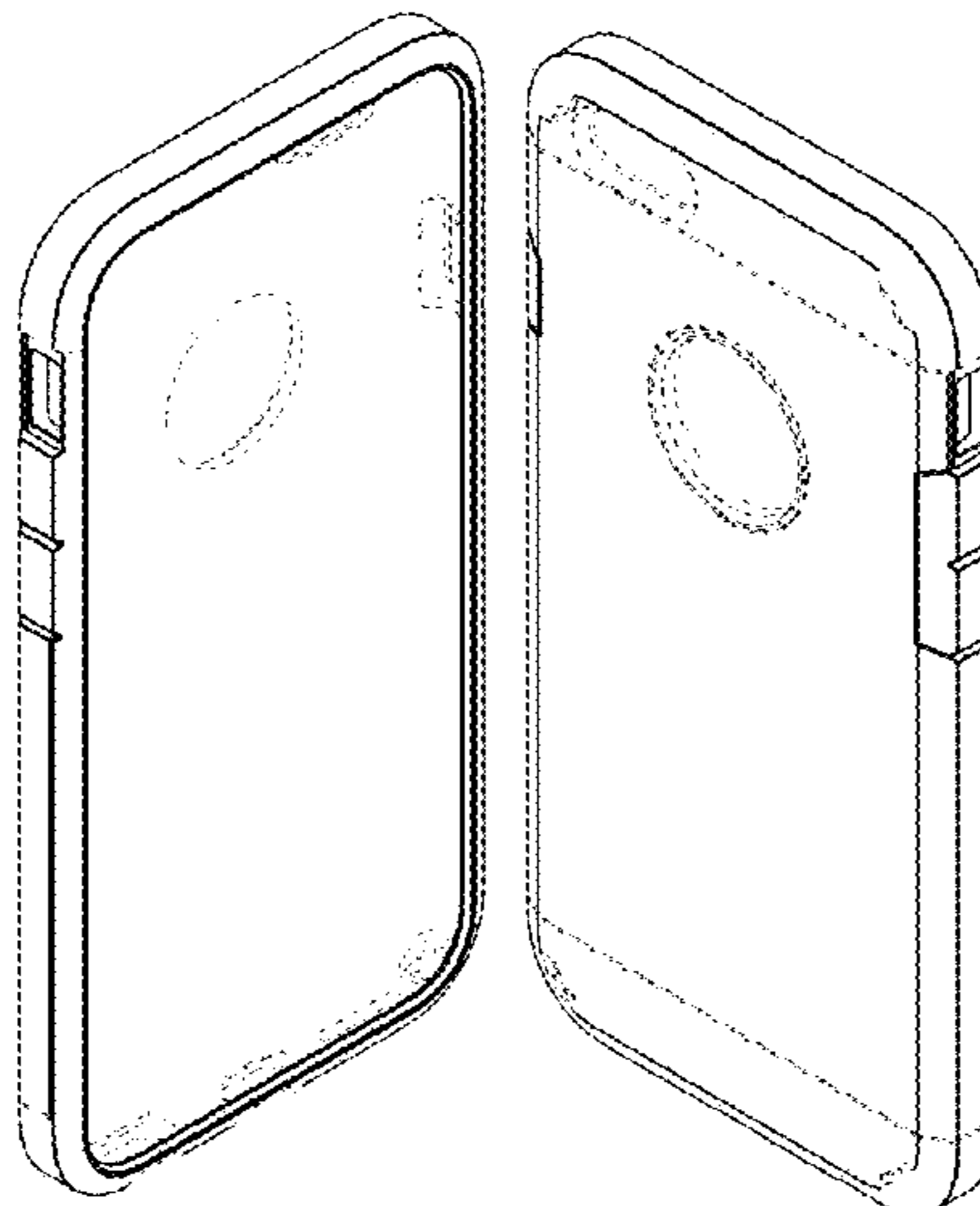

(56)

References Cited

U.S. PATENT DOCUMENTS

D741,844 S * 10/2015 Rayner D14/250
 D741,845 S 10/2015 Kim
 D743,389 S 11/2015 Akana
 D743,931 S 11/2015 Hubbard
 D744,471 S 12/2015 Fitzgerald
 D746,273 S 12/2015 Herbst
 D746,275 S * 12/2015 Mohammad D14/250
 D746,801 S 1/2016 Pan
 D746,805 S 1/2016 Kim
 D747,306 S 1/2016 Kim
 D748,614 S 2/2016 Qing
 D749,555 S 2/2016 Poon et al.
 D749,563 S 2/2016 Akana
 D749,567 S 2/2016 Lee
 D749,591 S 2/2016 Akana
 9,247,795 B2 2/2016 Kim
 D752,037 S 3/2016 Akana
 9,295,174 B2 3/2016 Witter
 9,301,414 B2 3/2016 Chao
 D753,099 S * 4/2016 Kim D14/250
 D753,641 S * 4/2016 Roberts D14/250
 D754,651 S 4/2016 Roberts
 D754,652 S * 4/2016 Roberts D14/250
 D756,340 S 5/2016 Babichenko
 D756,978 S 5/2016 Addonisio
 D759,641 S * 6/2016 Lai D14/250
 D775,112 S 12/2016 Hemesath et al.
 2011/0297578 A1 * 12/2011 Stiehl B29C 45/1676
 206/701
 2014/0216952 A1 * 8/2014 Liang H04M 1/18
 206/37
 2014/0284096 A1 9/2014 Wu

* cited by examiner

FIG. 1

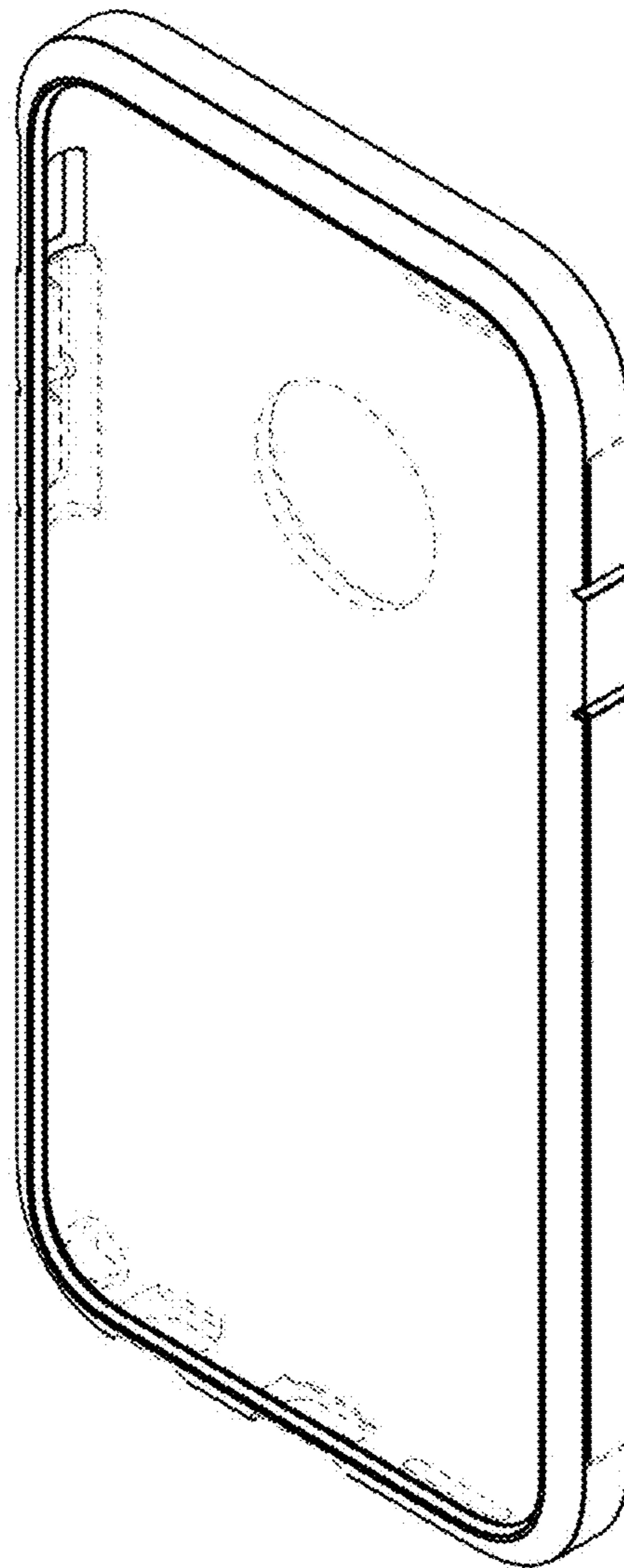

FIG. 2

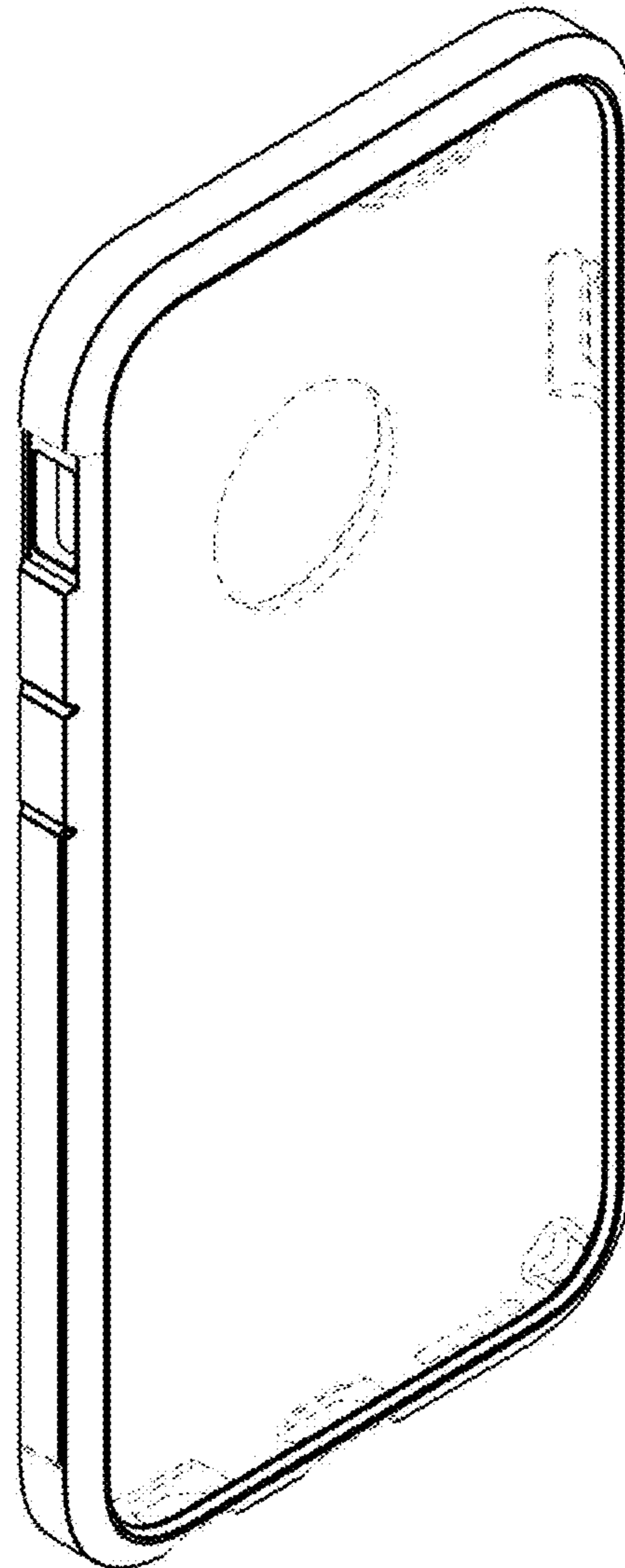

FIG. 3

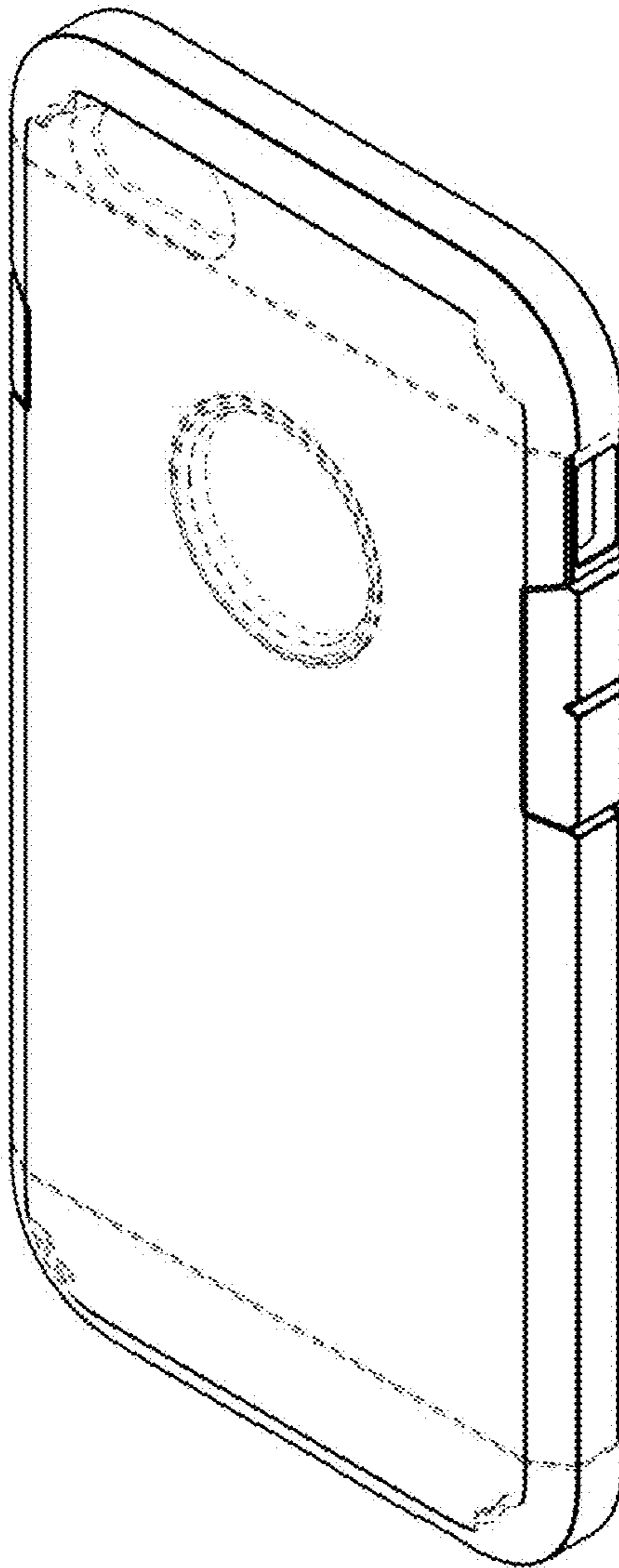

FIG. 4

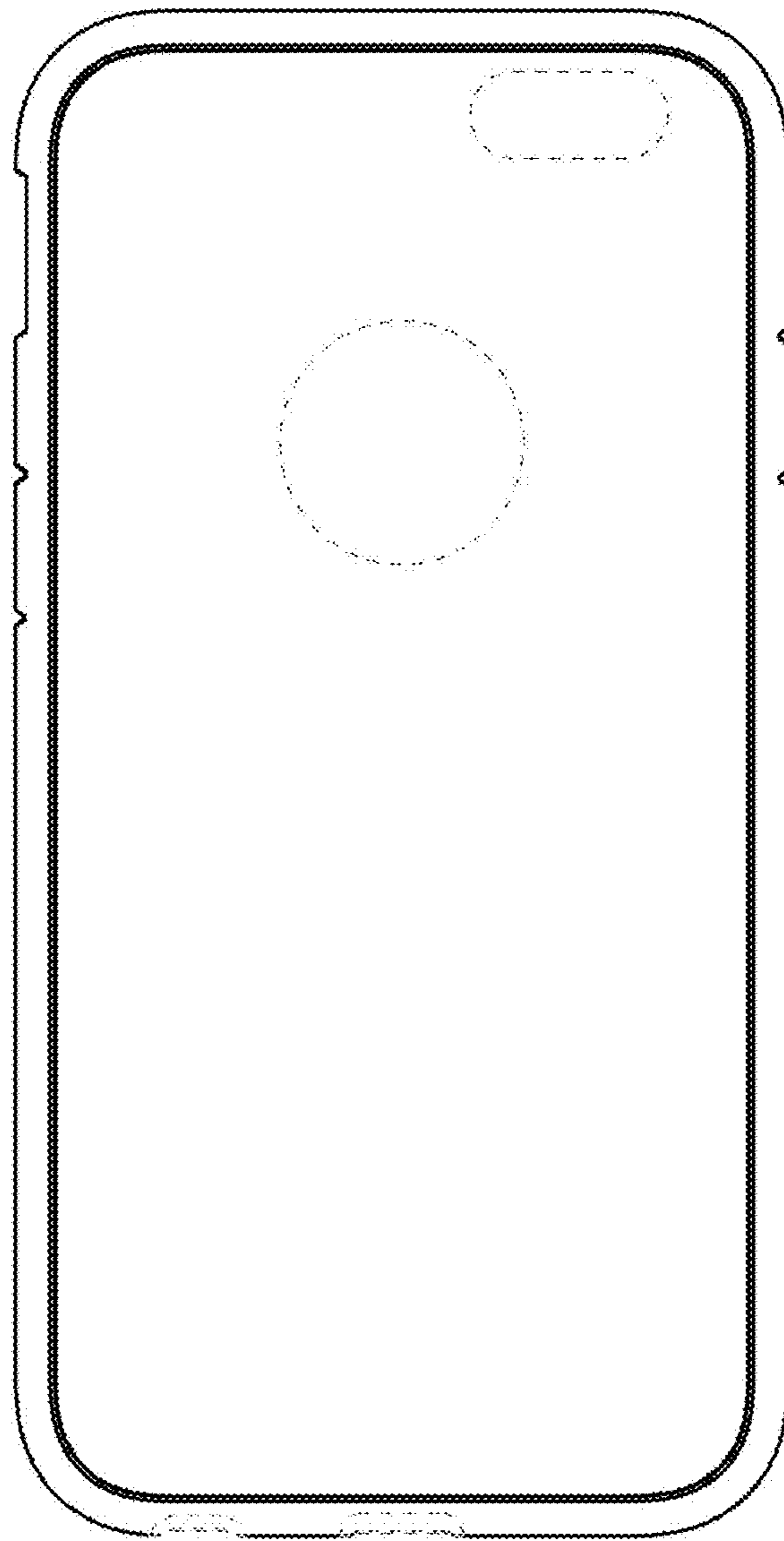

FIG. 5

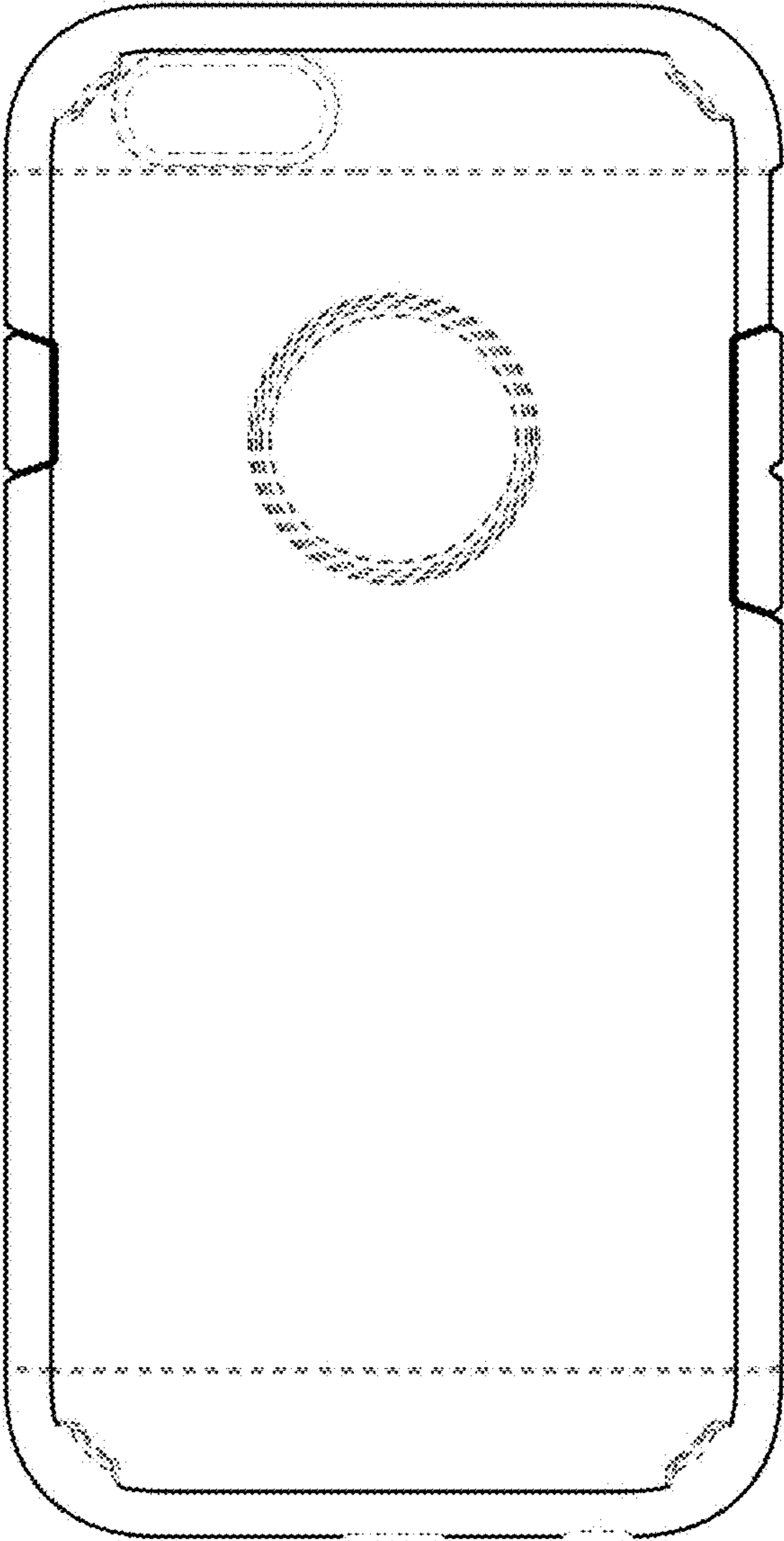

FIG. 6

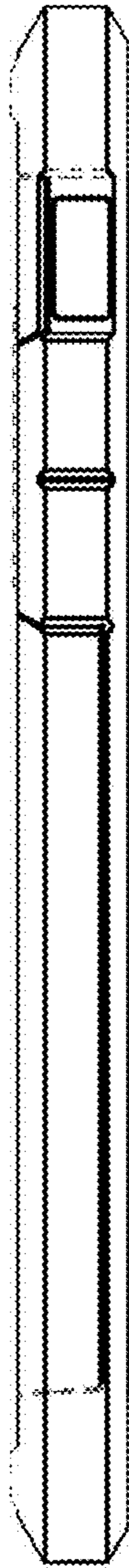

FIG. 7

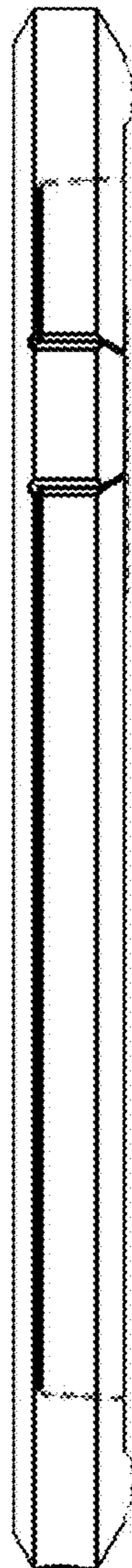

FIG. 8

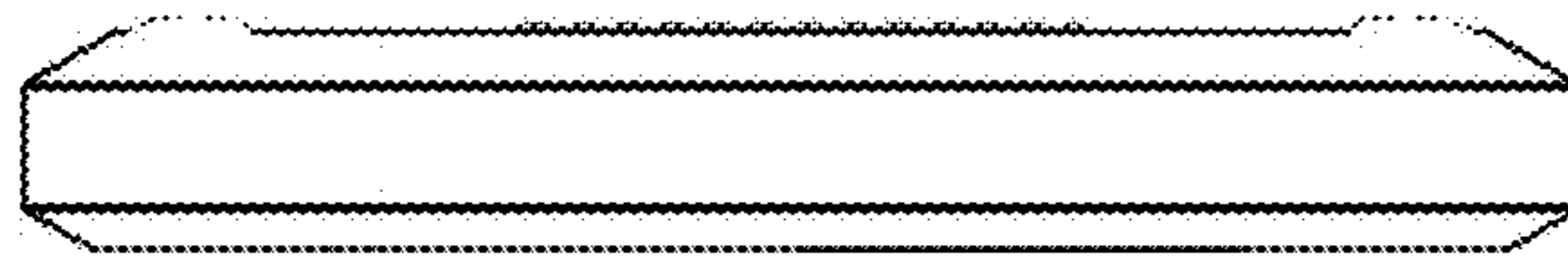

FIG. 9

