



US00D807320S

(12) **United States Design Patent** (10) **Patent No.:** **US D807,320 S**
Wong (45) **Date of Patent:** **** Jan. 9, 2018**

(54) **PORTABLE BLUETOOTH SPEAKER**

(71) Applicant: **Gibson Innovations Belgium NV,**
Leuven (BE)

(72) Inventor: **King Shun Cheong Wong, Wong Tai**
Sin (HK)

(73) Assignee: **Gibson Innovations Belgium NV,**
Leuven (BE)

(**) Term: **15 Years**

(21) Appl. No.: **29/545,907**

(22) Filed: **Nov. 17, 2015**

(30) **Foreign Application Priority Data**

May 19, 2015 (EM) 002703066

(51) **LOC (11) Cl.** **14-01**

(52) **U.S. Cl.**
USPC **D14/204**

(58) **Field of Classification Search**
USPC D14/188, 203.1-203.8, 204, 209.1,
D14/210-213, 215, 216; 181/143, 144,
181/148, 153, 157, 198, 199; 369/6-12;
381/300-303, 361-364, 366, 386-388
CPC G06F 1/1688; G10K 9/22; H04N 5/64;
H04R 1/02; H04R 1/021; H04R 1/025;
H04R 1/026; H04R 1/028; H04R 1/403;
H04R 1/2803; H04R 1/2834; H04R 5/02;
H04R 9/06; H04R 19/013; H04R
2201/021; H04R 2400/00; H04R 2499/11;
H05K 5/00; H05K 5/0086
See application file for complete search history.

(56) **References Cited**

U.S. PATENT DOCUMENTS

D509,817 S * 9/2005 Gong D14/155
D520,136 S * 5/2006 Keller D24/131

D535,770 S * 1/2007 Yuen D26/38
D557,433 S * 12/2007 Spiegel D14/168
D573,579 S * 7/2008 Yamaguchi D14/168
D617,305 S * 6/2010 Chen D14/168
D676,418 S * 2/2013 Suzuki D14/209.1
D686,186 S * 7/2013 Kaneko D14/168
D706,743 S * 6/2014 Lukic D14/204
RE45,068 E * 8/2014 Schmidt A61M 15/0086
128/200.23
2014/0079267 A1 * 3/2014 Lyons H04R 1/026
381/334

OTHER PUBLICATIONS

JBL Charge Bluetooth Speaker, announced Aug. 2013, [online], site visited Nov. 10, 2016. Available from Internet, <URL: <http://www.androidpolice.com>>.*

(Continued)

Primary Examiner — Derrick Holland
Assistant Examiner — Janice Patyk
(74) *Attorney, Agent, or Firm* — Bates & Bates, LLC

(57) **CLAIM**

The ornamental design for a portable bluetooth speaker, as shown and described.

DESCRIPTION

FIG. 1 is a perspective view of a portable bluetooth speaker, showing my new design;
FIG. 2 is a front view thereof;
FIG. 3 is a rear view thereof;
FIG. 4 is a right side view thereof;
FIG. 5 is a left side view thereof;
FIG. 6 is a top plan view thereof; and,
FIG. 7 is a bottom plan view thereof.
The broken line portions show unclaimed subject matter only and form no part of the claimed design.

1 Claim, 7 Drawing Sheets

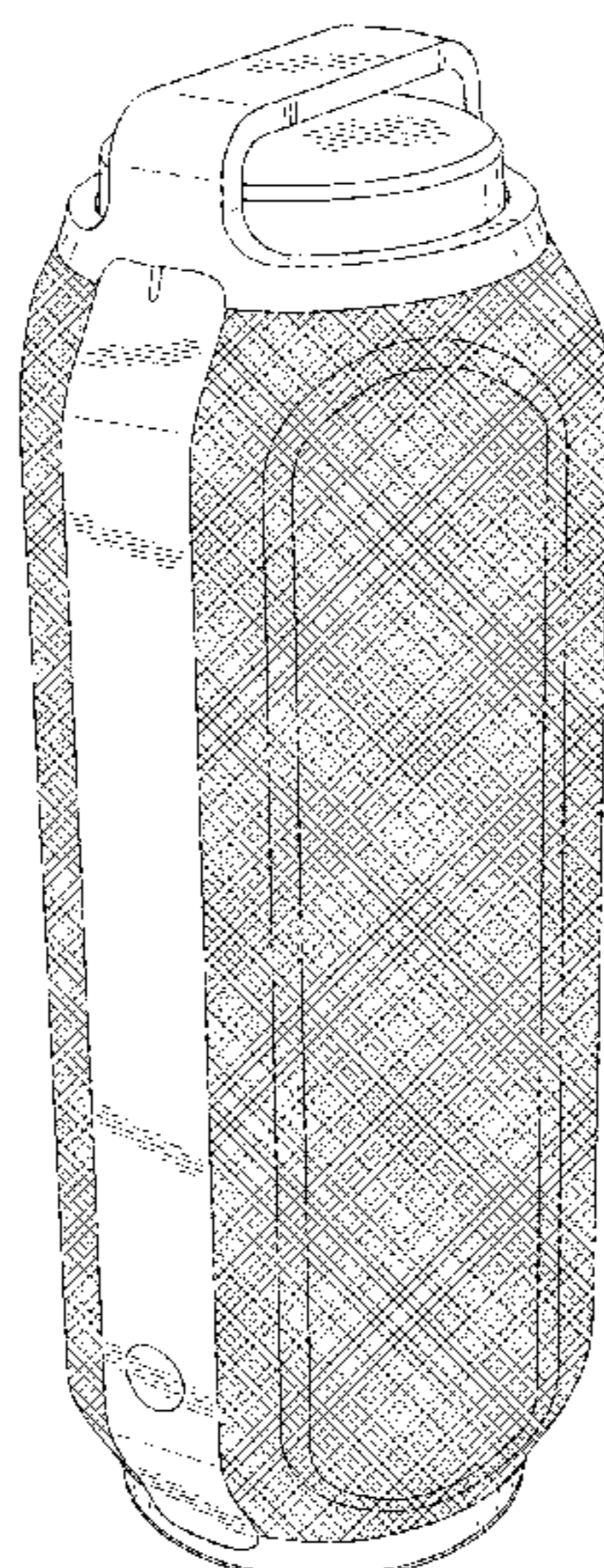

(56)

References Cited

OTHER PUBLICATIONS

JBL Flip Portable Stereo Speaker, announced Sep. 2012, [online], site visited Oct. 28, 2016. Available from Internet, <URL: <http://www.amazon.com>>.*

Scosche BoomBottle Speaker, announced Nov. 2014, [online], site visited Oct. 27, 2016. Available from Internet, <URL: <http://www.techgreatest.com>>.*

* cited by examiner

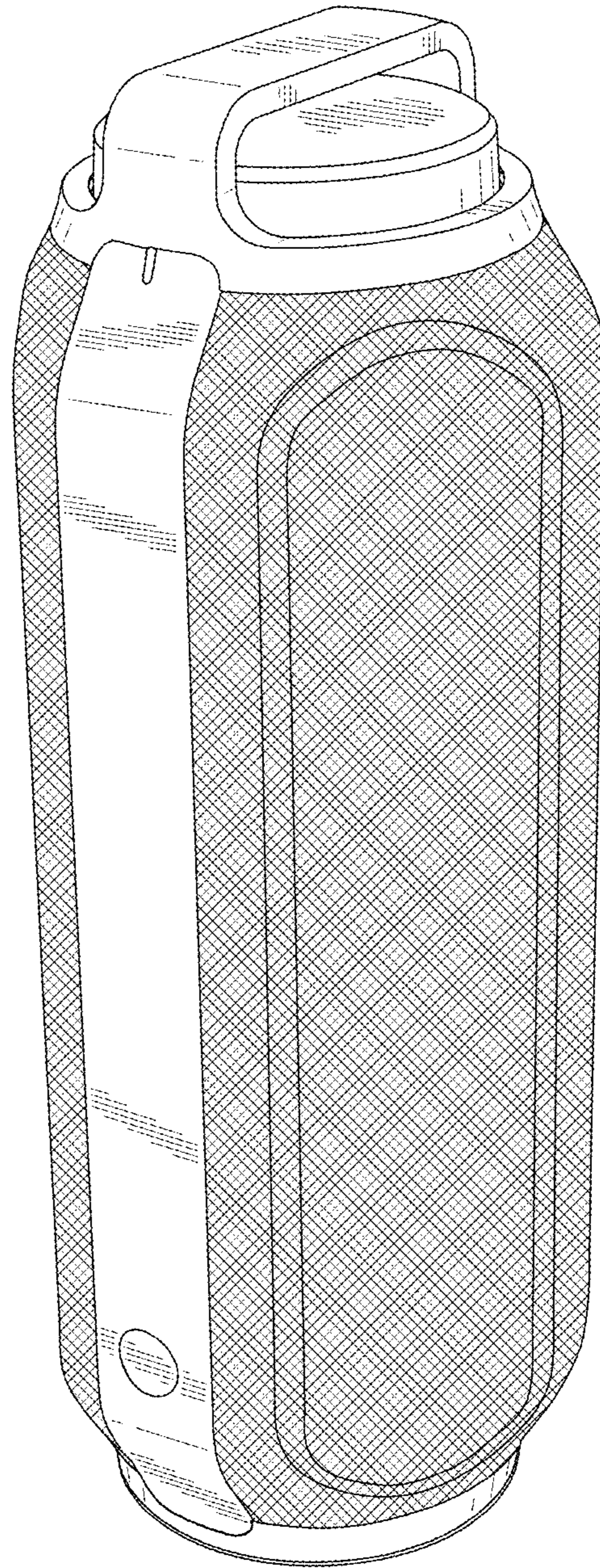

Fig. 1

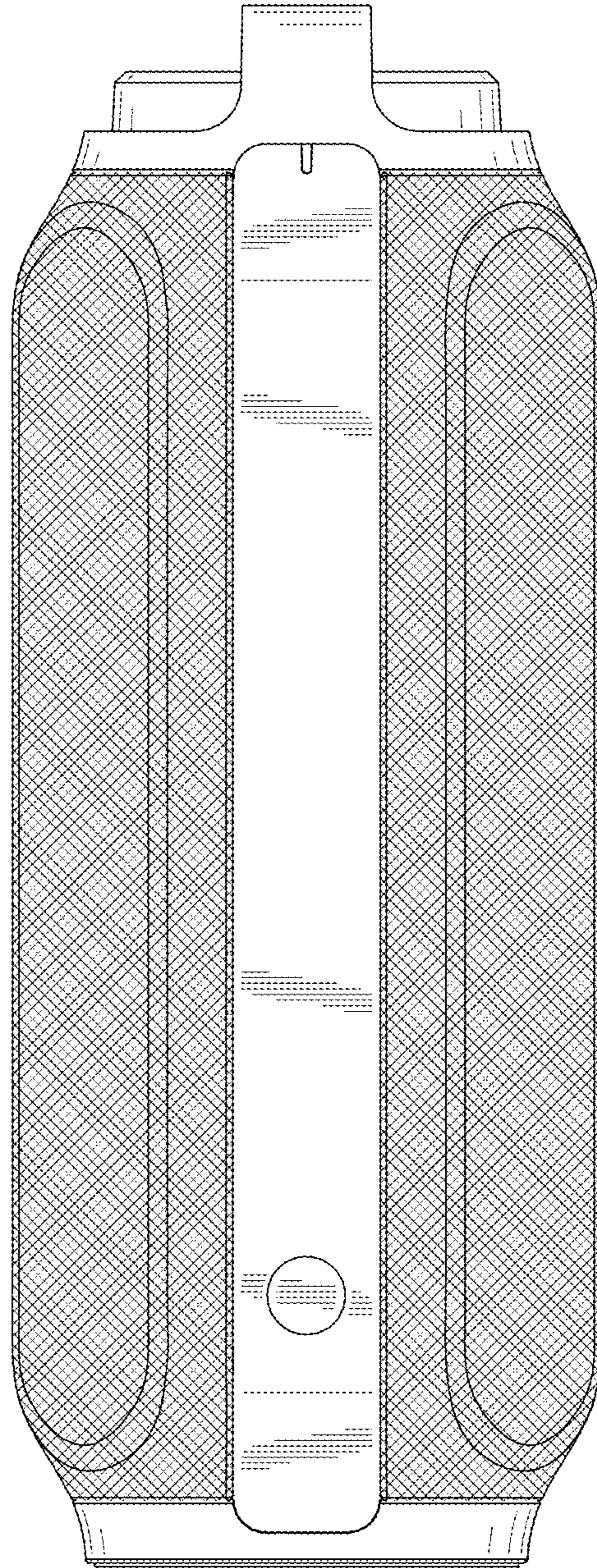

Fig. 2

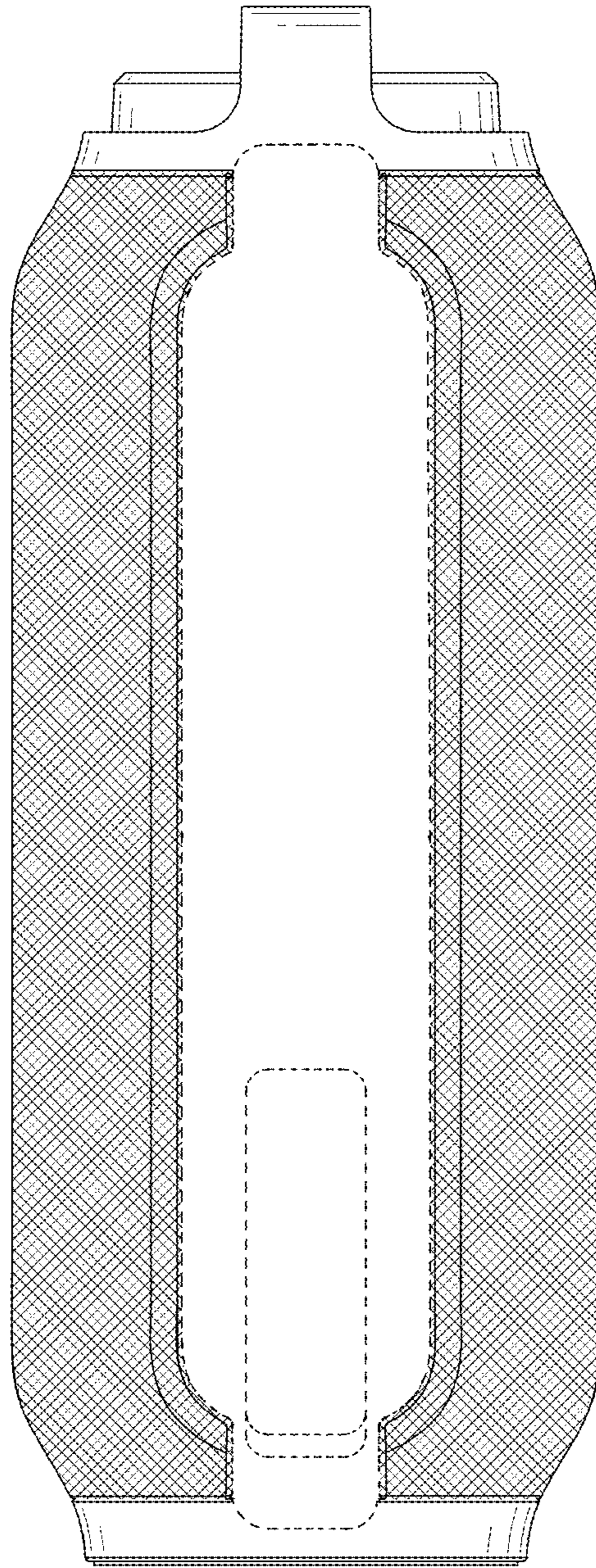

Fig. 3

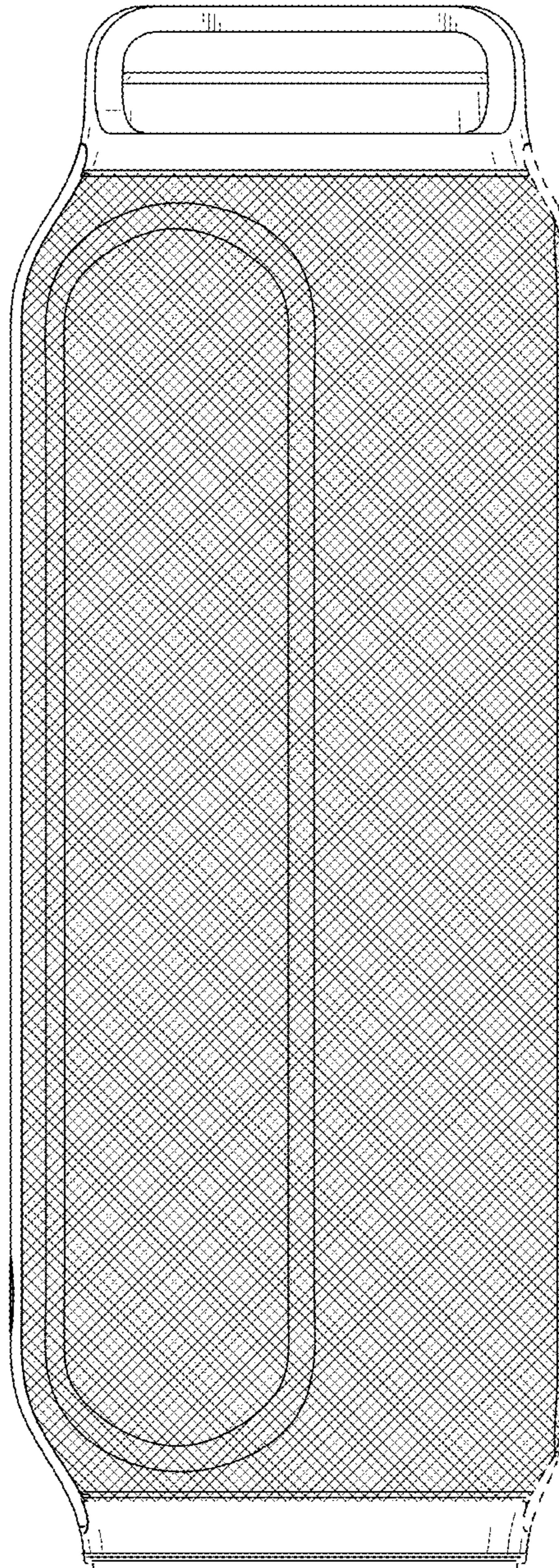

Fig. 4

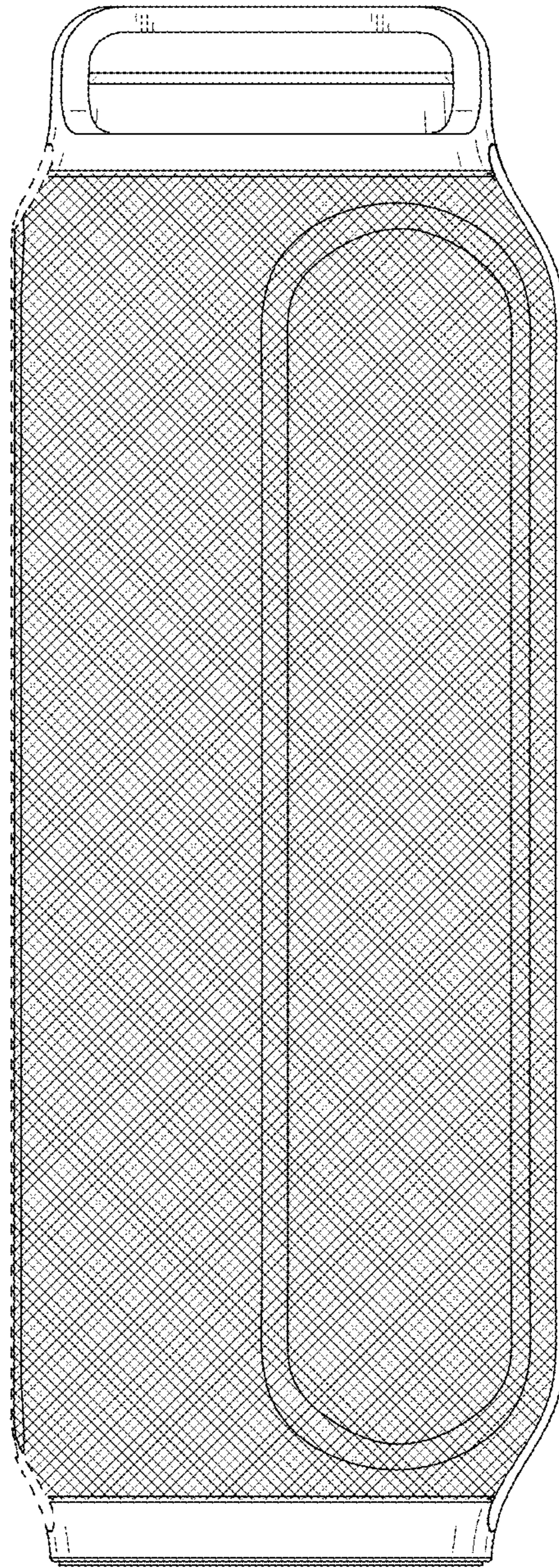

Fig. 5

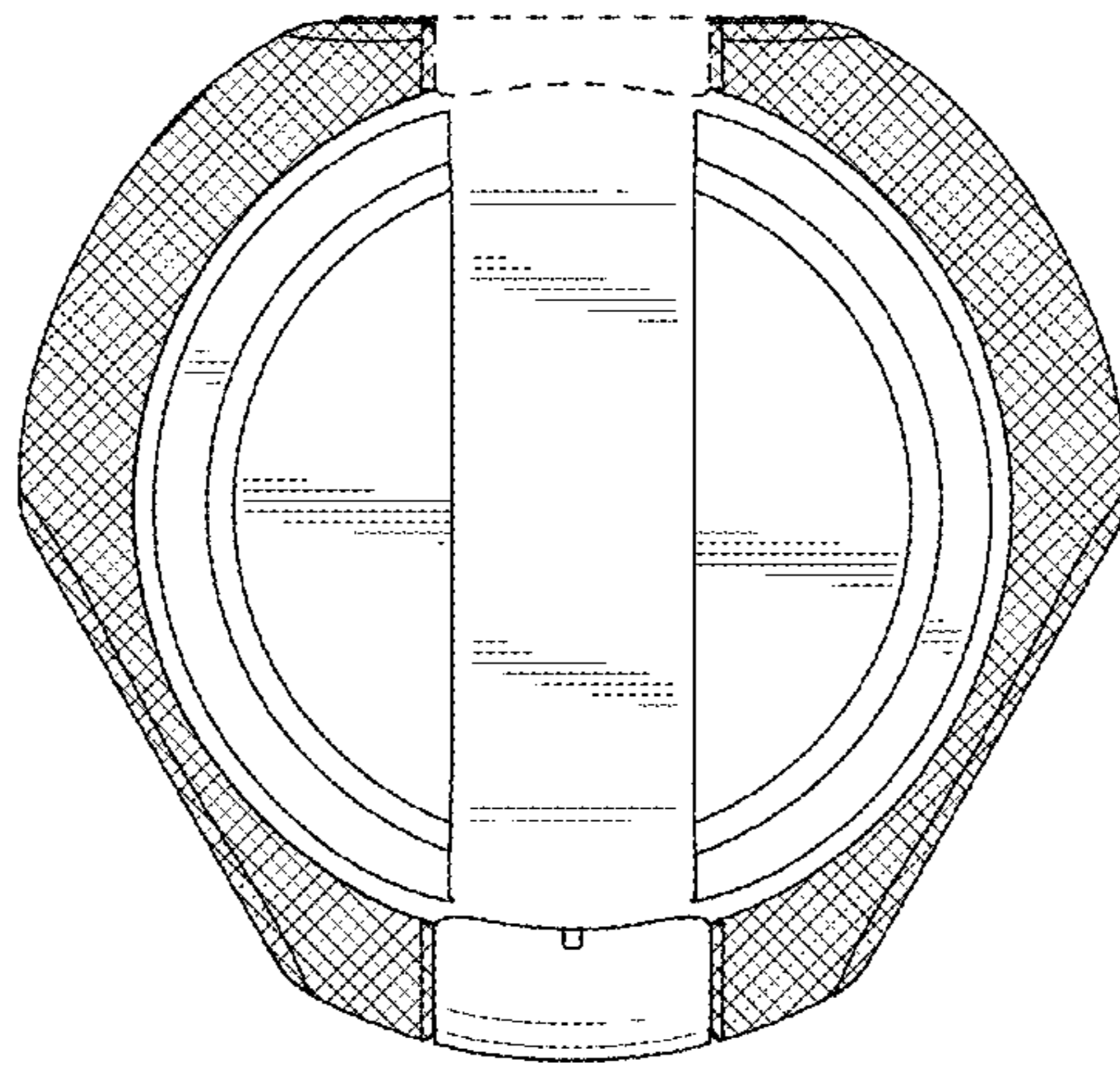

Fig. 6

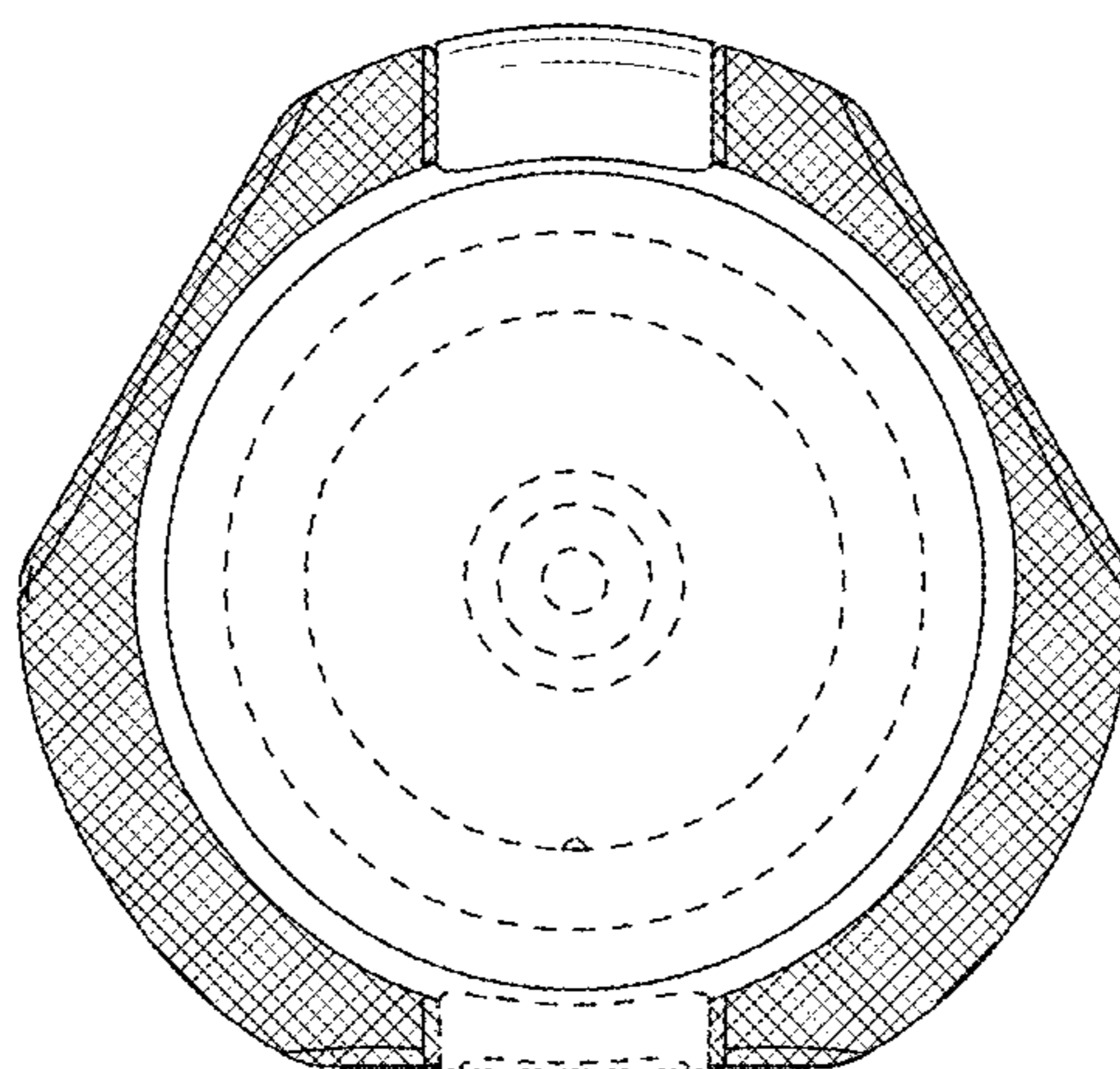

Fig. 7