



US00D807302S

(12) **United States Design Patent**  
**Shibata**

(10) **Patent No.:** **US D807,302 S**  
(45) **Date of Patent:** **\*\* Jan. 9, 2018**

- (54) **HOUSING FOR A WATERPROOF CONNECTOR**
- (71) Applicant: **Molex, LLC**, Lisle, IL (US)
- (72) Inventor: **Shinsuke Shibata**, Yamato (JP)
- (73) Assignee: **Molex, LLC**, Lisle, IL (US)
- (\*\*) Term: **15 Years**
- (21) Appl. No.: **29/549,507**
- (22) Filed: **Dec. 22, 2015**
- (30) **Foreign Application Priority Data**

Jun. 26, 2015 (JP) ..... 2015-014180

- (51) **LOC (11) Cl.** ..... **13-03**
- (52) **U.S. Cl.**
- USPC ..... **D13/149**
- (58) **Field of Classification Search**
- USPC ..... D13/123, 133, 134, 137.1–137.4, 138.1, 138.2, 139.1, 139.7, 144, 147, 149, 155, 156, 173, 184, 199
- CPC ..... H01R 13/50; H01R 13/502; H01R 13/52; H01R 13/521; H01R 13/58; H01R 13/62; H01R 13/627; H01R 13/629; H01R 9/00; H01R 13/00

See application file for complete search history.

(56) **References Cited**

**U.S. PATENT DOCUMENTS**

- D473,849 S \* 4/2003 Yeh ..... D13/147
  - 8,882,521 B2 11/2014 Conway
  - 9,028,267 B2 \* 5/2015 Furuya ..... H01R 9/16 439/271
  - 2001/0044228 A1 11/2001 Noro
  - 2002/0127912 A1 \* 9/2002 Hamai ..... H01R 13/5208 439/587
  - 2006/0040535 A1 2/2006 Koshy
- (Continued)

**FOREIGN PATENT DOCUMENTS**

- JP D1347083 12/2008
- JP D1358540 5/2009

**OTHER PUBLICATIONS**

Molex—CMC Sealed, Hybrid, Modular Connectors and Headers, dated Nov. 11, 2013, [online], [site visited Dec. 13, 2016]. Available from Internet, <URL: <https://www.youtube.com/watch?v=7ZNe4qvVICk>>.\*

*Primary Examiner* — Thomas Johannes  
*Assistant Examiner* — Shawn T Gingrich  
(74) *Attorney, Agent, or Firm* — James A. O'Malley

(57) **CLAIM**

The ornamental design for a housing for a waterproof connector, as shown and described.

**DESCRIPTION**

FIG. 1 is a perspective view of an embodiment of a housing for a waterproof connector;  
 FIG. 2 is another perspective view of the embodiment depicted in FIG. 1;  
 FIG. 3 is an elevated side view of the embodiment depicted in FIG. 1 taken from a first direction;  
 FIG. 4 is an elevated side view of the embodiment depicted in FIG. 1 taken from a second direction, the second direction being opposite the first direction;  
 FIG. 5 is a top view of the embodiment depicted in FIG. 1;  
 FIG. 6 is a bottom view of the embodiment depicted in FIG. 1;  
 FIG. 7 is an elevated front view of the embodiment depicted in FIG. 1; and,  
 FIG. 8 is an elevated rear view of the embodiment depicted in FIG. 1.

The broken line portion of the figure drawings is included to show portions of the article that form no part of the claimed design.

**1 Claim, 5 Drawing Sheets**

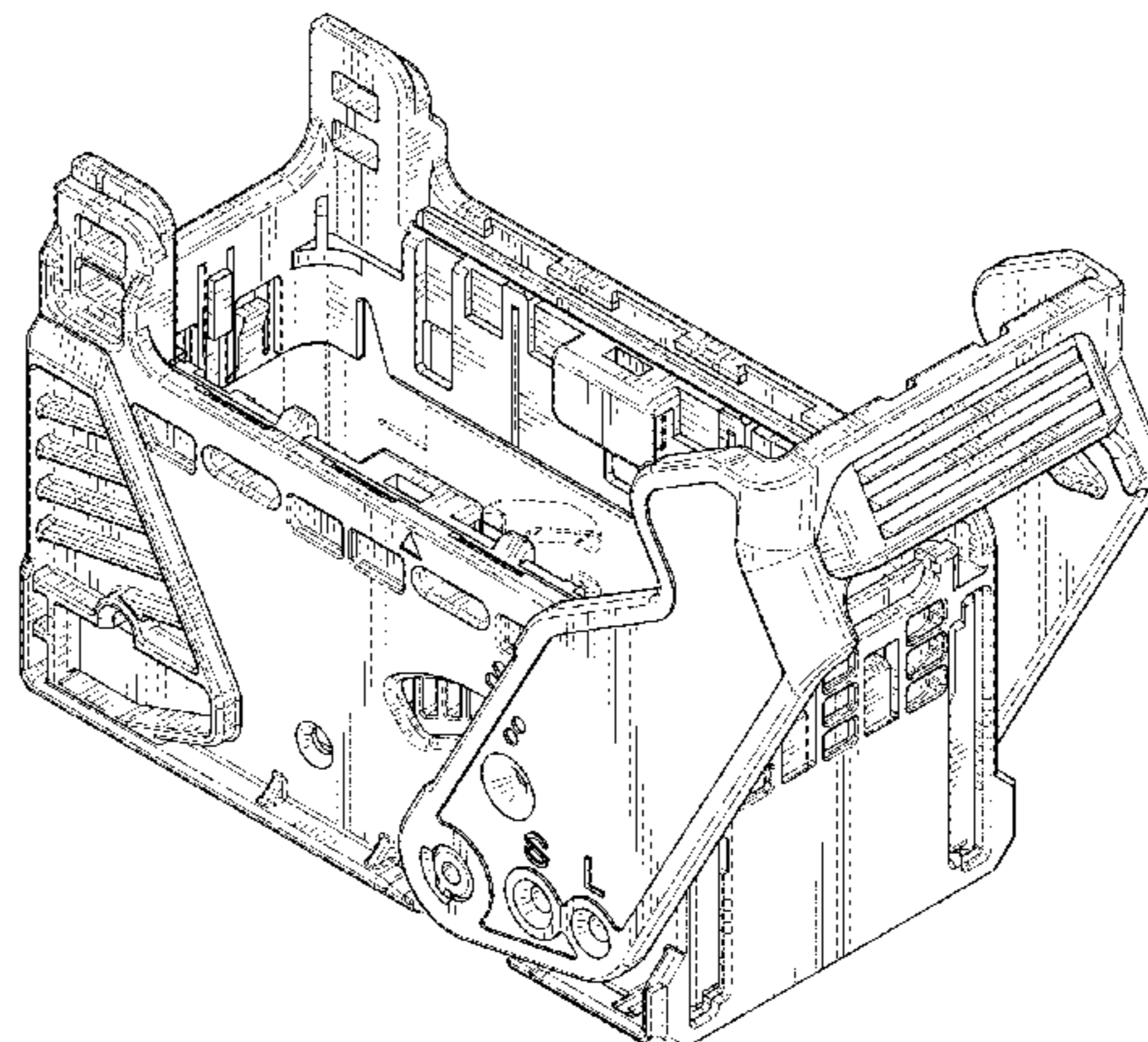
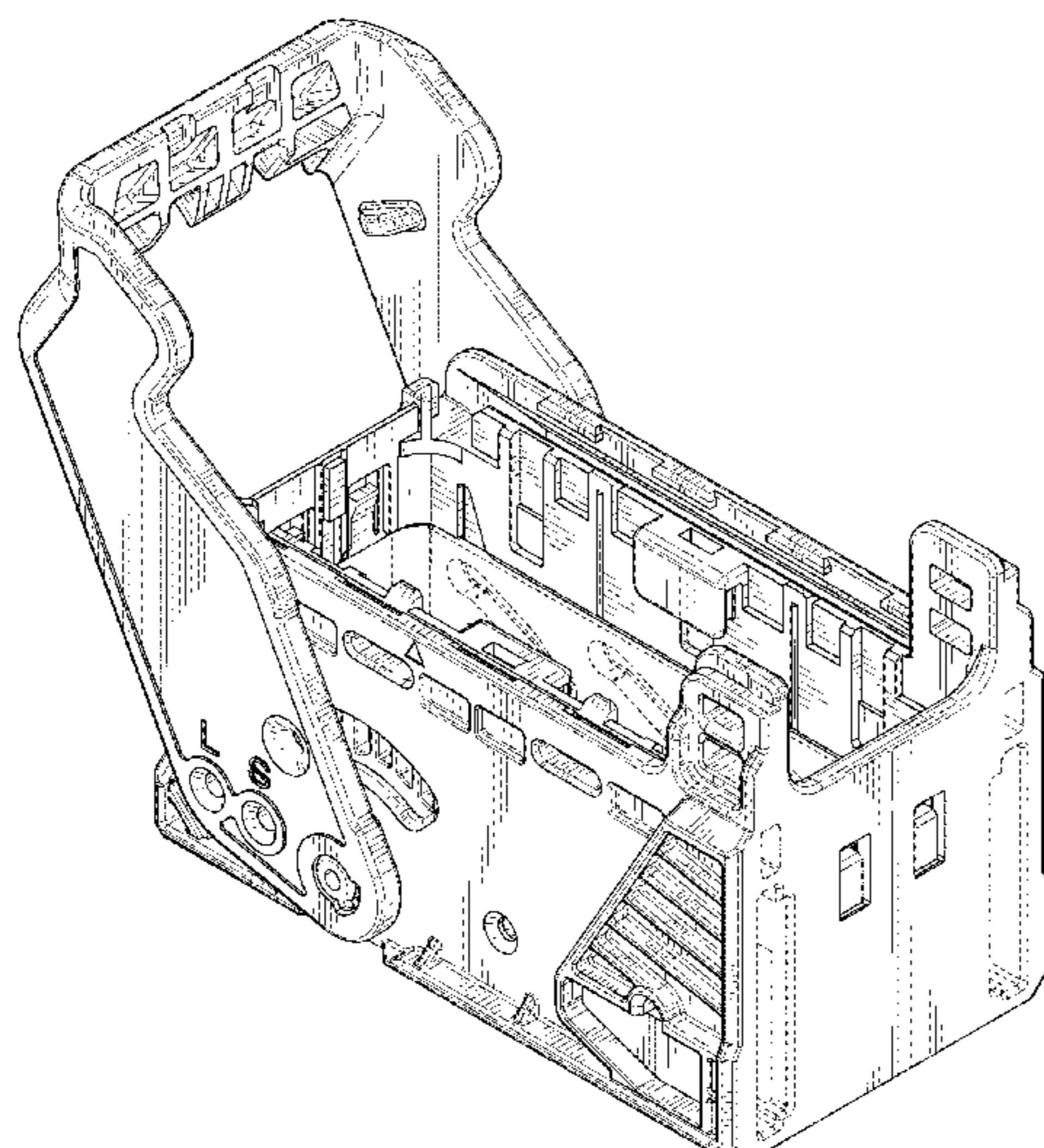

(56)

**References Cited**

U.S. PATENT DOCUMENTS

2007/0128900 A1\* 6/2007 Bauman ..... H01R 13/62955  
439/157  
2007/0197081 A1 8/2007 Patterson  
2010/0081313 A1 4/2010 Komiyama  
2011/0014805 A1 1/2011 Sakamaki  
2011/0021048 A1 1/2011 Sakamaki  
2011/0021064 A1\* 1/2011 Shibata ..... H01R 13/5213  
439/470  
2011/0034049 A1 2/2011 Shishikura  
2011/0086529 A1 4/2011 Kobayashi  
2011/0086533 A1 4/2011 Kobayashi  
2012/0208383 A1 8/2012 Kobayashi  
2016/0079699 A1\* 3/2016 Kobayashi ..... H01R 13/506  
439/660  
2016/0190738 A9\* 6/2016 Henmi ..... H01R 13/62933  
439/157  
2016/0315413 A1\* 10/2016 Kobayashi ..... H01R 13/521  
2016/0336686 A1\* 11/2016 Obata ..... H01R 13/62938

\* cited by examiner

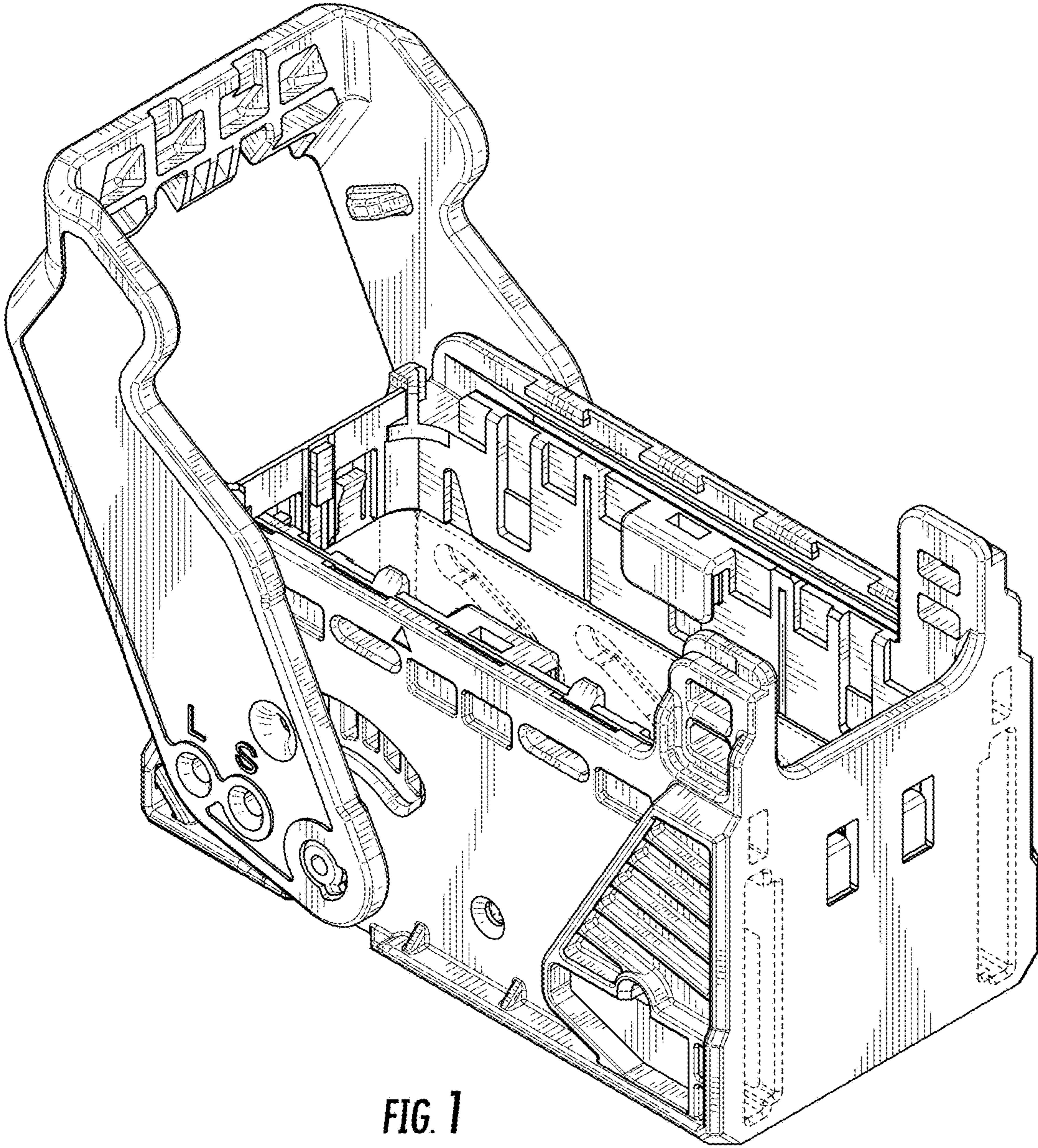

FIG. 1

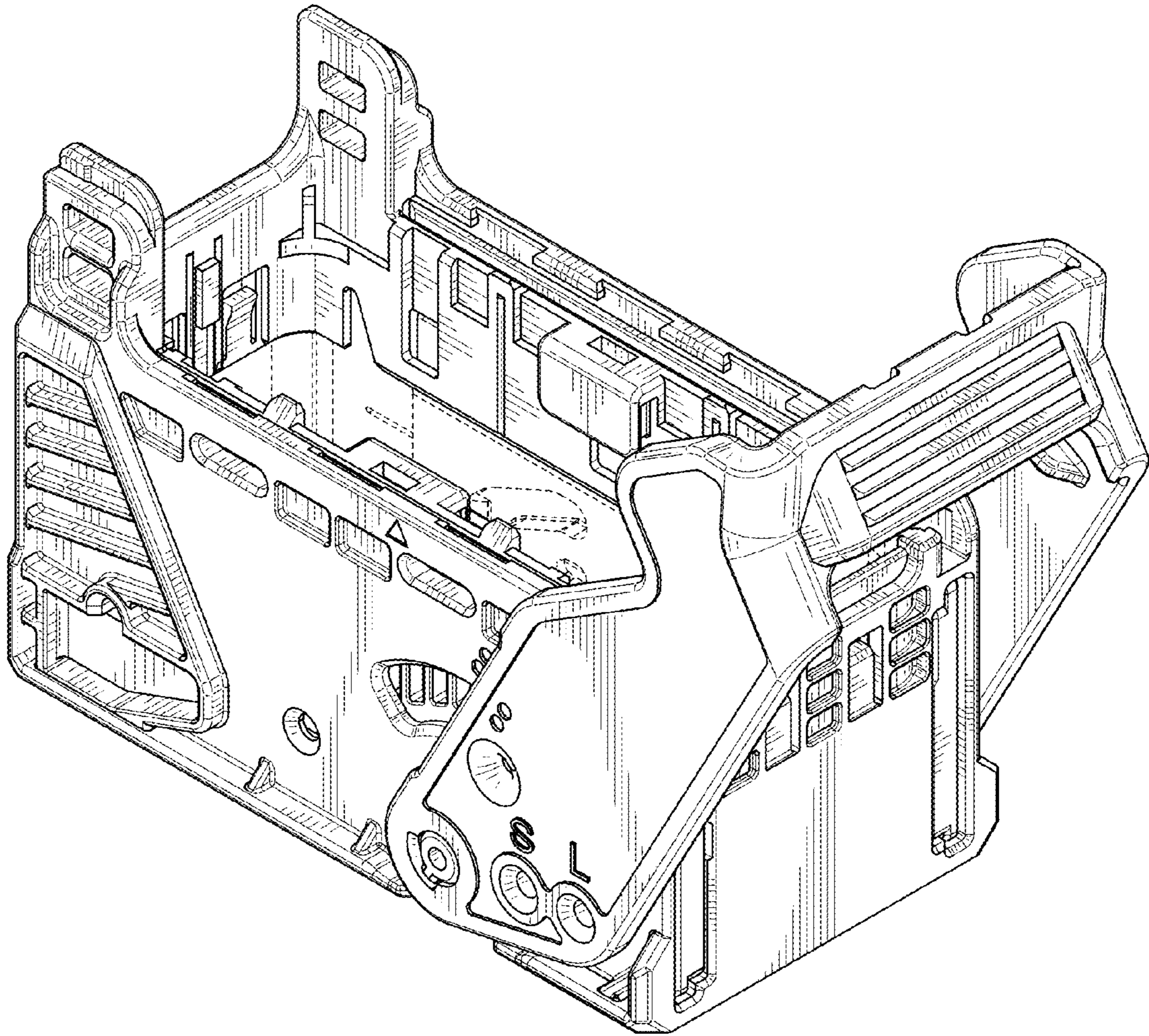

FIG. 2

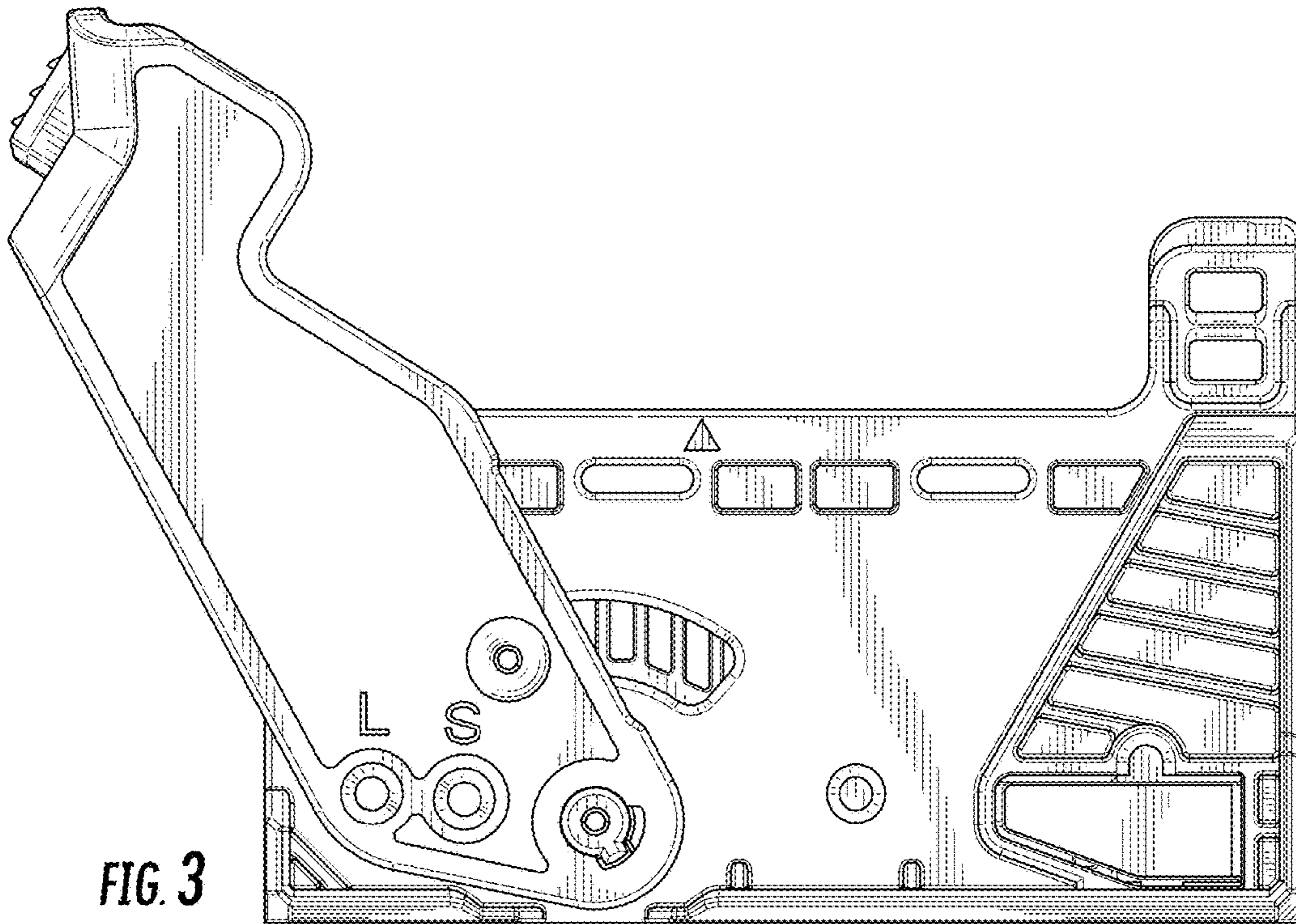

FIG. 3

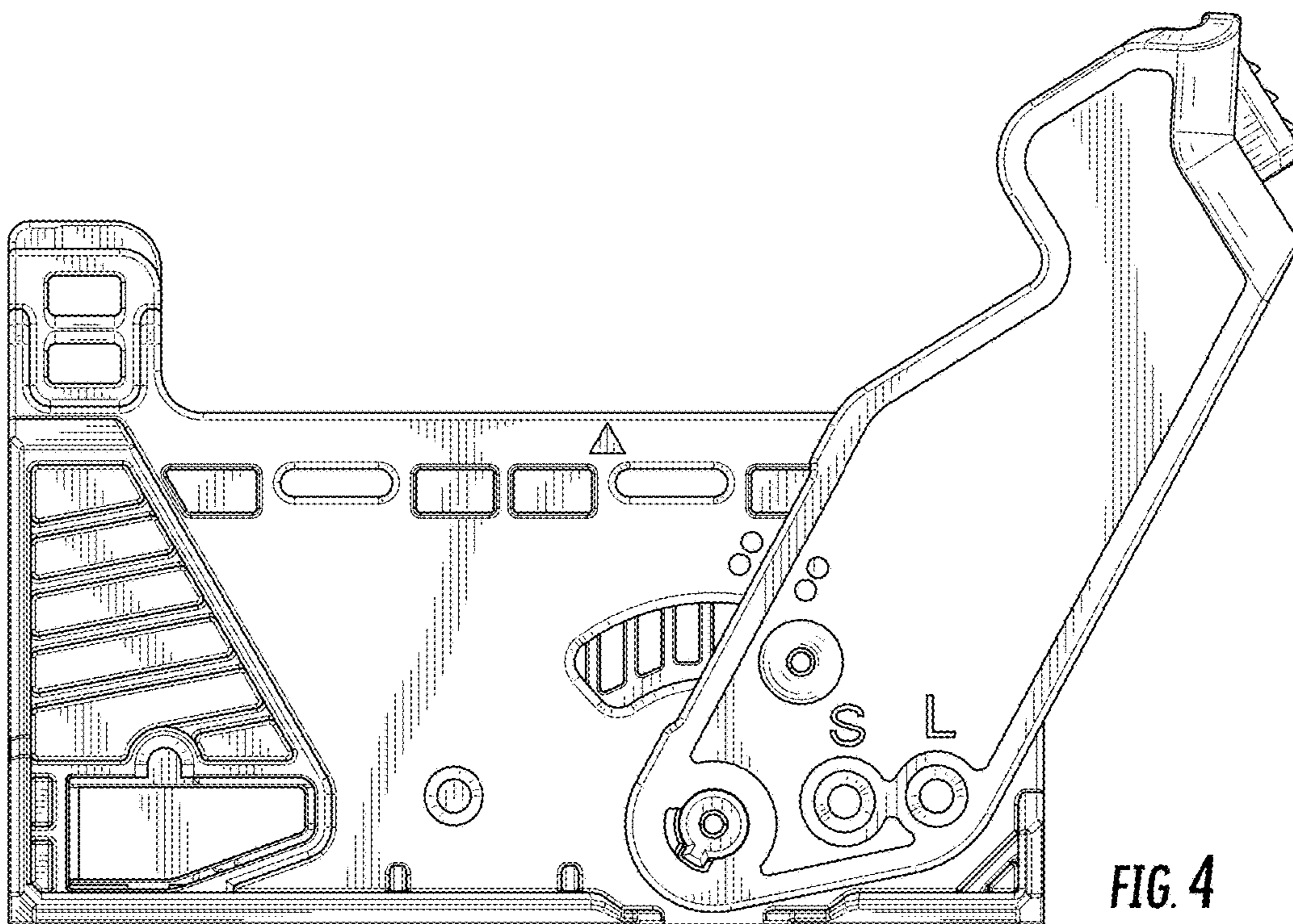

FIG. 4

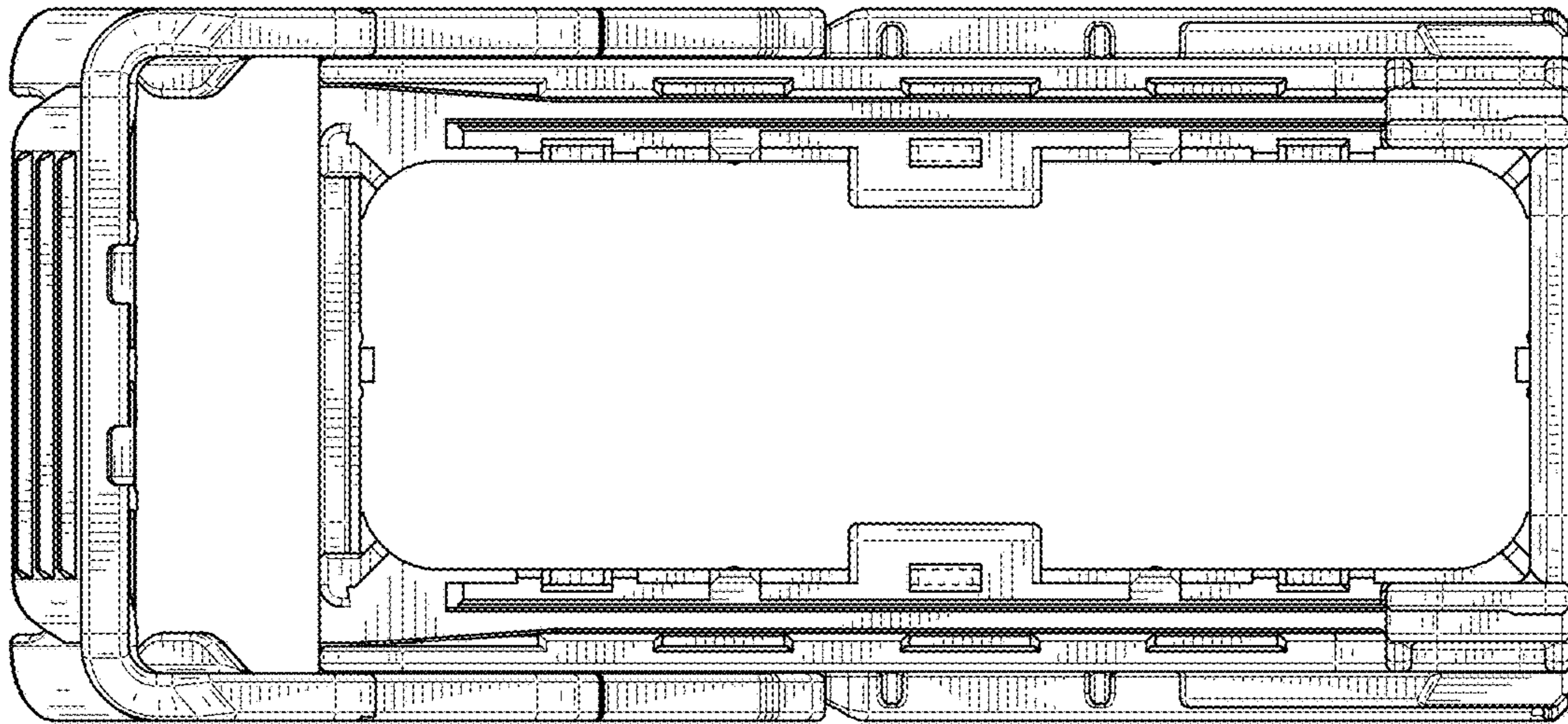

FIG. 5

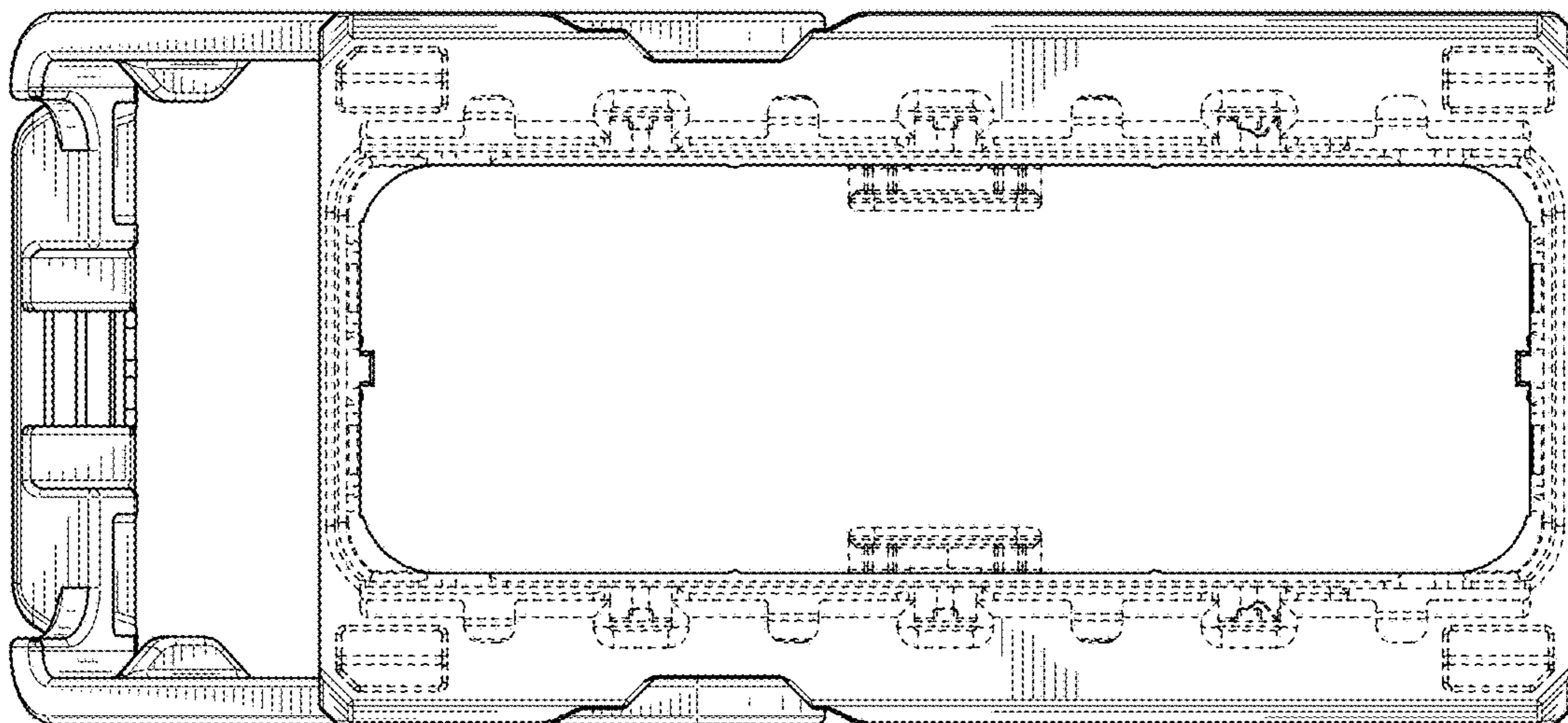

FIG. 6

FIG. 7

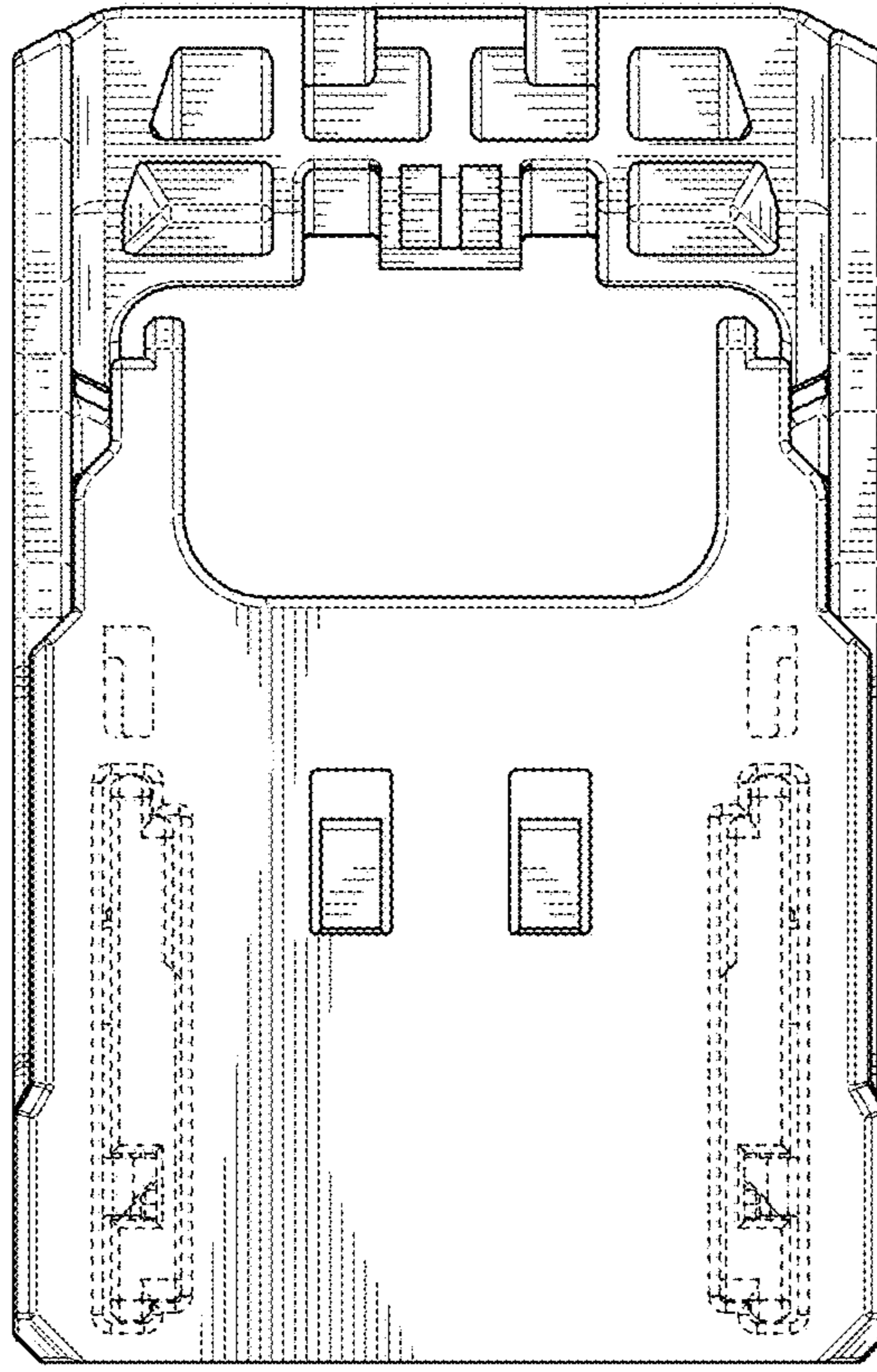

FIG. 8

