



US00D807266S

(12) **United States Design Patent**  
**Hasegawa**

(10) **Patent No.:** **US D807,266 S**  
(45) **Date of Patent:** **\*\* Jan. 9, 2018**

(54) **INSTRUMENT PANEL FOR AUTOMOBILE**

(71) Applicant: **Nissan Motor Co., Ltd.**, Yokohama,  
Kanagawa (JP)

(72) Inventor: **Satoru Hasegawa**, Kanagawa (JP)

(73) Assignee: **Nissan Motor Co., Ltd.**, Yokohama  
(JP)

(\*\*) Term: **15 Years**

(21) Appl. No.: **29/584,462**

(22) Filed: **Nov. 15, 2016**

(30) **Foreign Application Priority Data**

May 16, 2016 (JP) ..... 2016-010319

(51) **LOC (11) Cl.** ..... **12-16**

(52) **U.S. Cl.**  
USPC ..... **D12/192**

(58) **Field of Classification Search**

USPC ..... D12/192, 415, 110, 114; D15/17, 28;  
D10/46, 98, 102-103, 122-127

CPC ..... G08G 1/096883; G01C 21/16; G01C  
21/3688; G01C 21/30

See application file for complete search history.

(56) **References Cited**

**U.S. PATENT DOCUMENTS**

D470,809 S	2/2003	Asahi et al.	
D597,009 S	7/2009	Tan et al.	
D654,004 S	2/2012	Hamajima et al.	
D697,849 S	1/2014	Tanaka et al.	
D699,171 S	2/2014	Matsuo	
D705,145 S	5/2014	Mangan et al.	
D727,816 S	4/2015	Takagi et al.	
D730,793 S	6/2015	Ishikawa	
D737,186 S	8/2015	Nakao	
D762,152 S *	7/2016	Inagaki	D12/192
D763,154 S *	8/2016	Chang	D12/192

D763,155 S *	8/2016	Sahs	D12/192
D770,953 S *	11/2016	Tanaka	D12/192
D771,541 S *	11/2016	Shouno	D12/192
D776,029 S *	1/2017	Callum	D12/192
D778,796 S *	2/2017	Gommier	D12/192
D780,649 S *	3/2017	Tanaka	D12/192
D791,026 S *	7/2017	Willis	D12/192

(Continued)

**FOREIGN PATENT DOCUMENTS**

JP	D1307327 S	8/2007
JP	D1449379 S	8/2012
JP	D1461418 S	2/2013

(Continued)

*Primary Examiner* — Katrina A Betton

(74) *Attorney, Agent, or Firm* — Global IP Counselors,  
LLC

(57) **CLAIM**

The ornamental design for an instrument panel for an automobile, as shown and described.

**DESCRIPTION**

FIG. 1 is a front elevational view of an instrument panel for an automobile in accordance with our new design; FIG. 2 is a top plan view thereof; FIG. 3 is a bottom plan view thereof; FIG. 4 is a right side elevational view thereof; FIG. 5 is a left side elevational view thereof; FIG. 6 is a first side perspective view thereof; and, FIG. 7 is a second side perspective view thereof. In the drawings, the broken lines in FIGS. 2-7 depict portions of the article that form no part of the claimed design.

A second embodiment of our new design is identical to the first embodiment. The second embodiment of our new design includes the mirror image of the instrument panel shown in FIGS. 1 to 7.

**1 Claim, 7 Drawing Sheets**

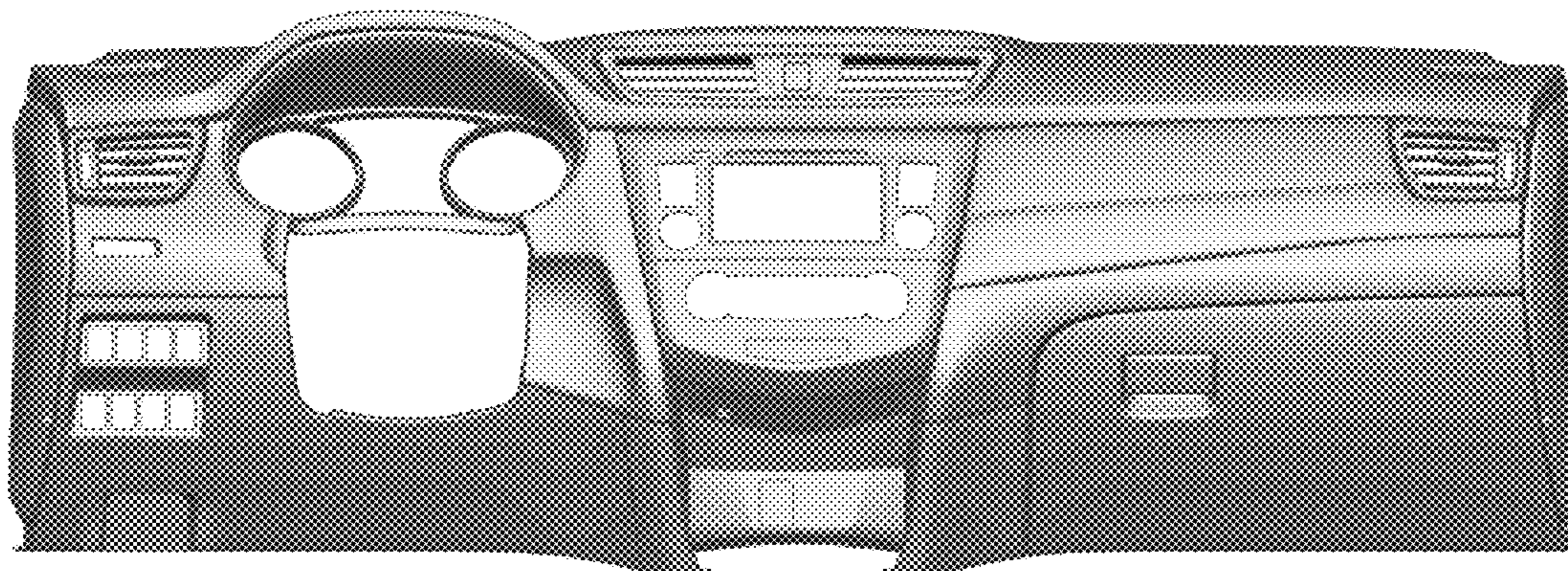

(56)

**References Cited**

U.S. PATENT DOCUMENTS

D791,663 S \* 7/2017 Gonzalez ..... D12/192  
D791,664 S \* 7/2017 Igarashi ..... D12/192

FOREIGN PATENT DOCUMENTS

JP D1462021 S 2/2014  
JP D1501851 S 7/2014  
JP D1492915 S 3/2015  
JP D1481492 S 10/2015  
JP D1543330 S 2/2016  
JP D1549260 S 5/2016  
JP D1560453 S 10/2016  
JP D1561330 S 1/2017  
JP D1531741 S 8/2017

\* cited by examiner

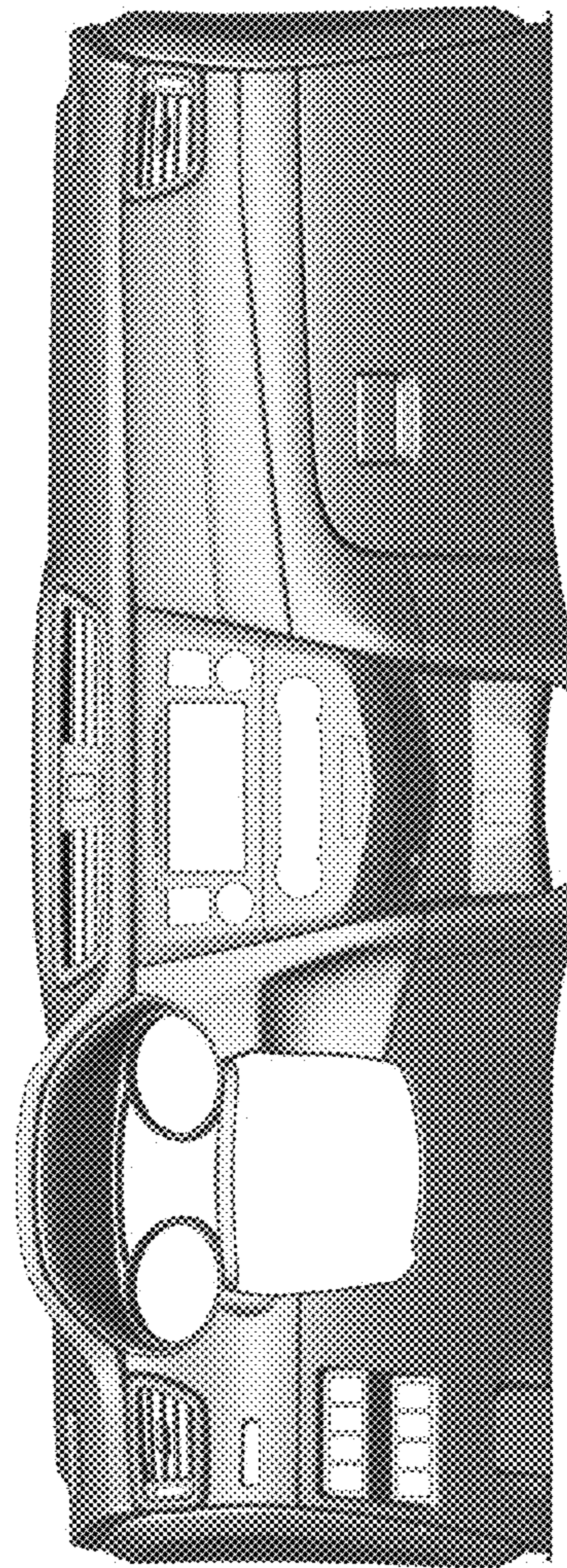

FIG. 1



FIG. 2

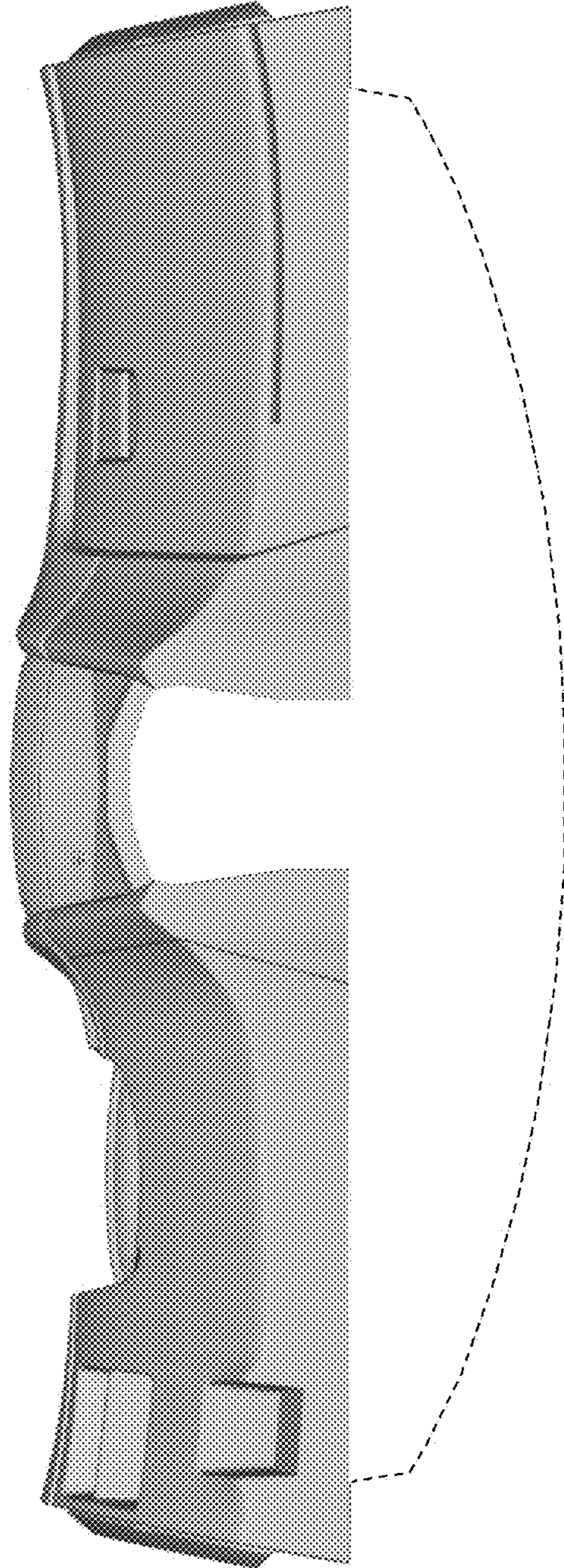

FIG. 3

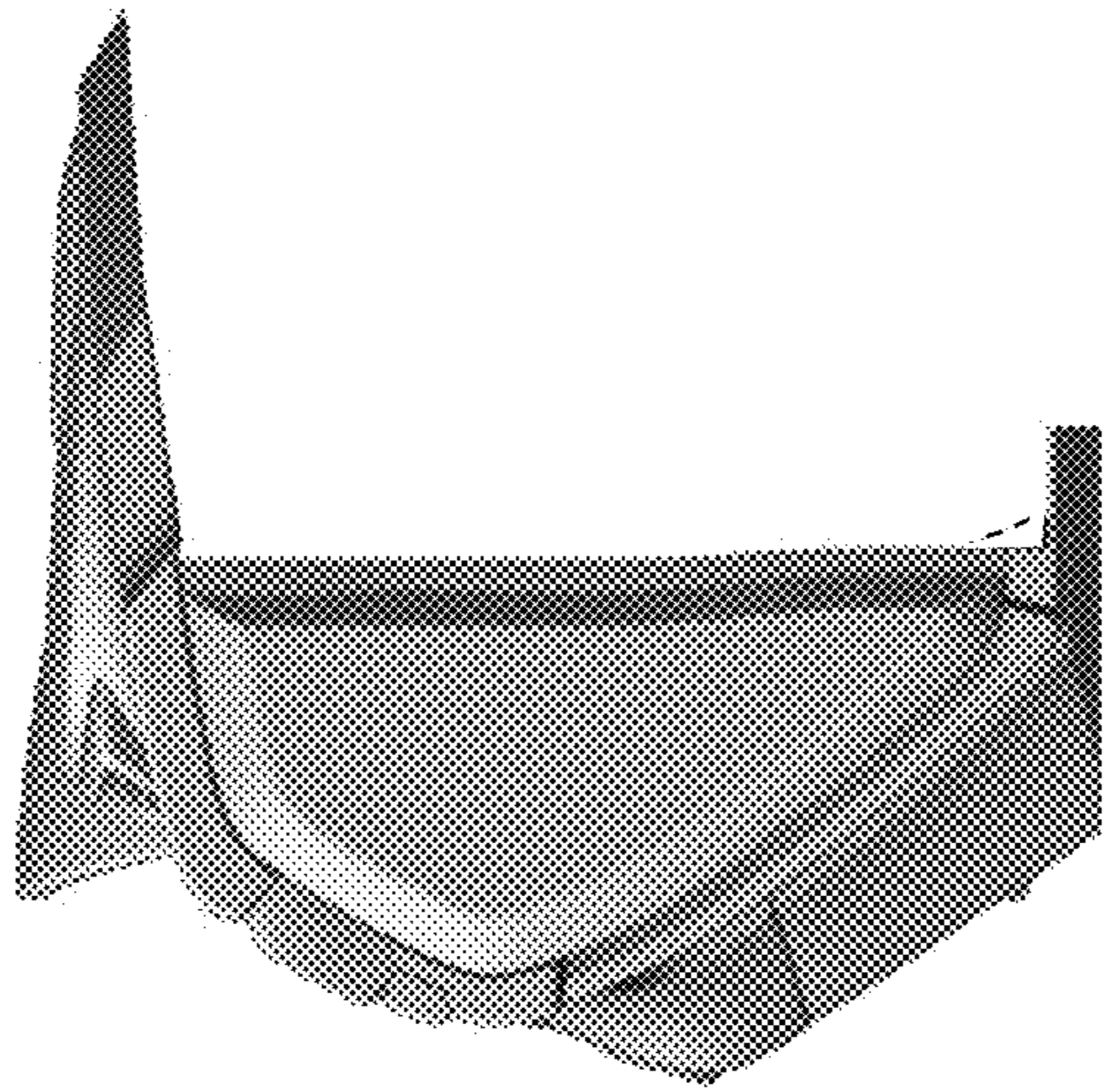

FIG. 4

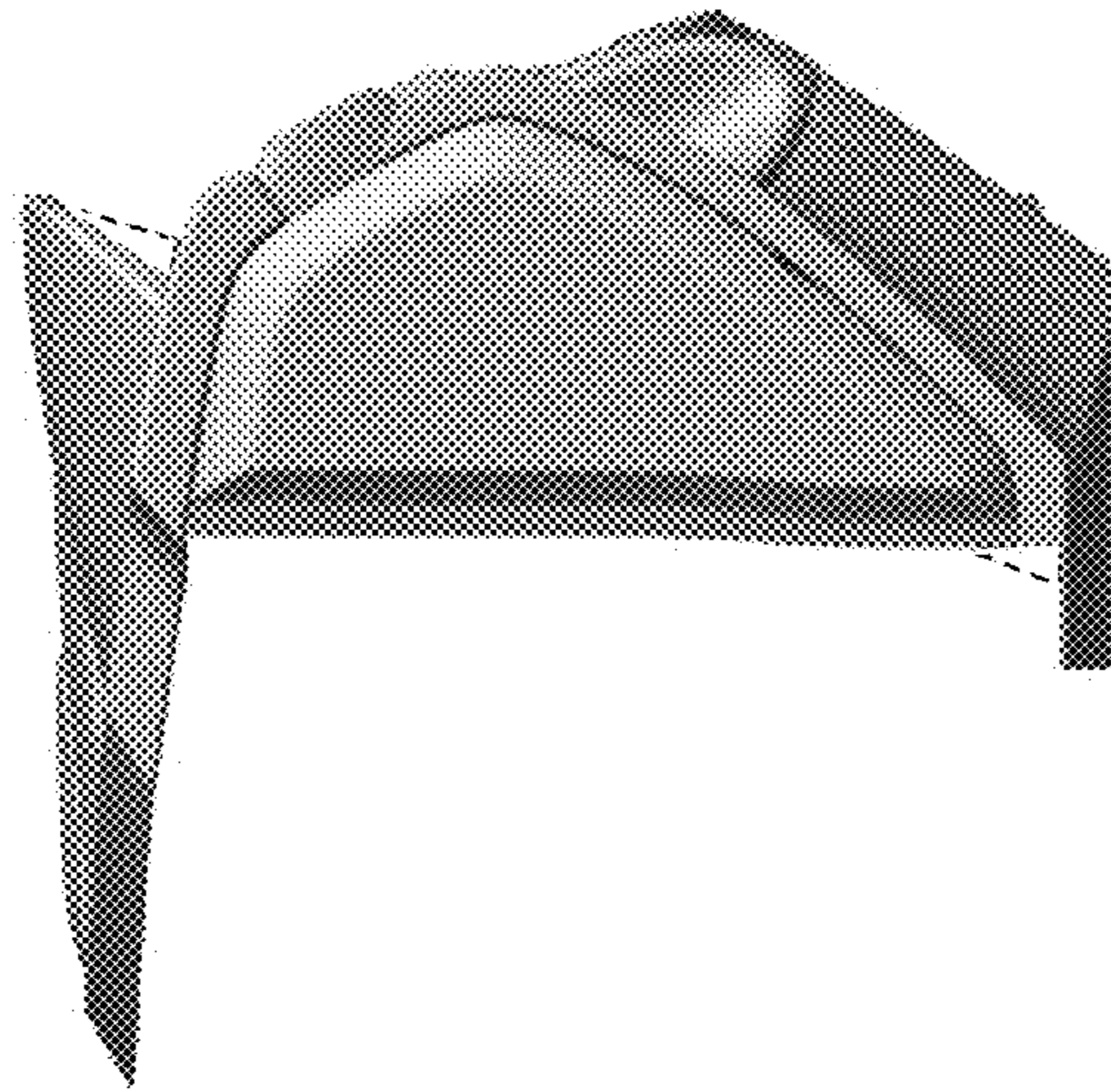

FIG. 5

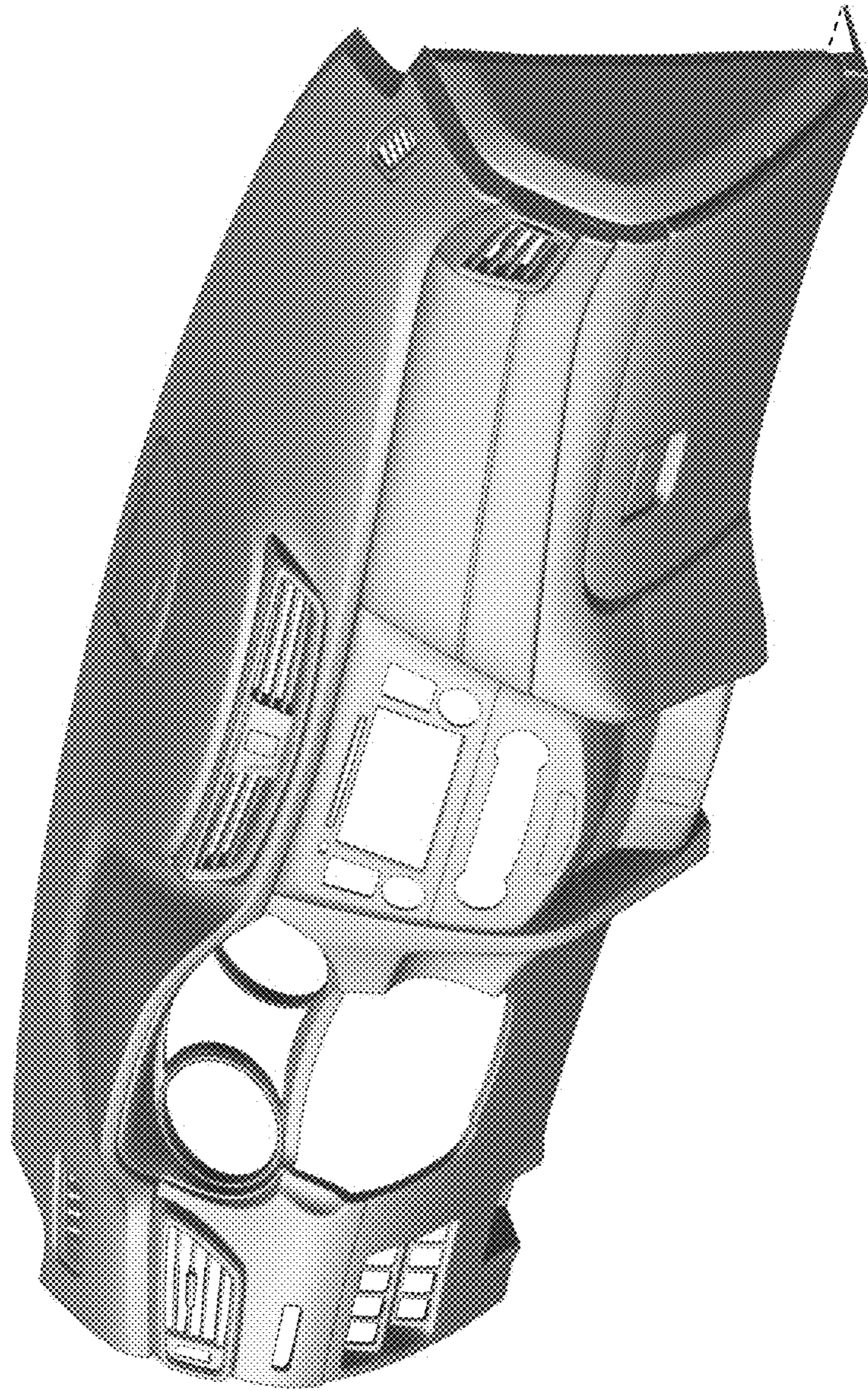

FIG. 6



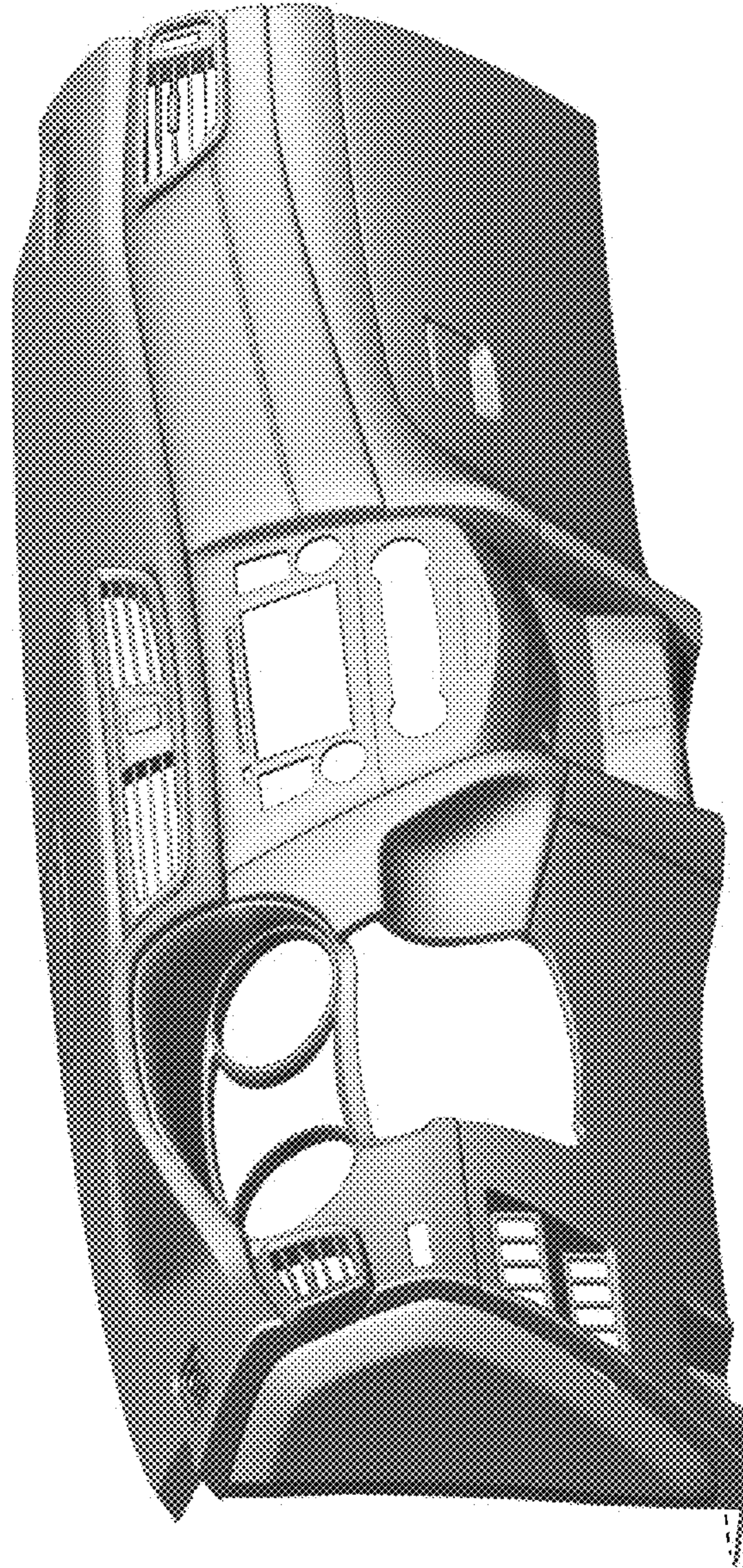

FIG. 7