



US00D807203S

(12) **United States Design Patent** (10) **Patent No.:** **US D807,203 S**  
**Bedol et al.** (45) **Date of Patent:** **\*\* Jan. 9, 2018**

(54) **KITCHEN TIMER**  
(71) Applicants: **Mark A. Bedol**, Claremont, CA (US);  
**Robert Thompson**, Baltimore, MD (US)  
(72) Inventors: **Mark A. Bedol**, Claremont, CA (US);  
**Robert Thompson**, Baltimore, MD (US)  
(73) Assignee: **Mark A. Bedol**, Claremont, CA (US)  
(\*\*) Term: **15 Years**

D431,197 S \* 9/2000 Pau ..... D10/40  
D460,920 S \* 7/2002 Kalman ..... D10/22  
D466,029 S \* 11/2002 Joss ..... D10/22  
D467,186 S \* 12/2002 Chen ..... D10/15  
D472,162 S \* 3/2003 Dullemen ..... D10/40  
D475,636 S \* 6/2003 Li ..... D10/15  
D475,637 S \* 6/2003 Lau ..... D10/22  
6,595,683 B1 \* 7/2003 Cetera ..... G04B 37/0066  
368/225  
D485,498 S \* 1/2004 Tong ..... D10/15  
D510,878 S \* 10/2005 Sellers ..... D10/40  
D523,760 S \* 6/2006 Bedol ..... D10/1  
D564,913 S \* 3/2008 Smith-Kielland ..... D10/40  
D564,914 S \* 3/2008 Smith-Kielland ..... D10/40  
(Continued)

(21) Appl. No.: **29/505,741**  
(22) Filed: **Jan. 20, 2016**  
(51) **LOC (11) Cl.** ..... **10-02**  
(52) **U.S. Cl.**  
USPC ..... **D10/40**  
(58) **Field of Classification Search**  
USPC ..... D10/1-29, 30-39, 40, 44, 122-132  
CPC .... G04B 45/00; G04B 45/02; G04B 45/0069;  
G04B 19/00; G04B 19/04; G04B 19/044;  
G04B 37/00; G04B 37/0066; G04F 1/00;  
G04F 1/005; G04F 3/08; G04F 13/06  
See application file for complete search history.

(56) **References Cited**  
U.S. PATENT DOCUMENTS  
D98,769 S \* 3/1936 Horwitt ..... D10/15  
D190,750 S \* 6/1961 Marti ..... D10/22  
3,008,288 A \* 11/1961 Marti ..... G04B 37/0066  
220/4.21  
3,854,279 A \* 12/1974 Edmunds ..... G04G 9/04  
368/234  
3,974,638 A \* 8/1976 Haber ..... G04C 3/001  
200/61.45 R  
D244,835 S \* 6/1977 Sheth ..... D10/15  
4,226,829 A \* 10/1980 Mike ..... A61L 9/12  
239/54  
D337,056 S \* 7/1993 Medina ..... D10/22  
D338,836 S \* 8/1993 Marsh ..... D10/2

**OTHER PUBLICATIONS**  
Polder Digital Hourglass Kitchen timer| posted at amazon.com Jul. 12, 2006 © 1996-2017 [online][site visited Apr. 10, 2017]. Available from Internet: <[https://www.amazon.com/dp/B000I9JJD2/ref=asc\\_df\\_B000I9JJD24930919?smid=ATVPDKIKX0DER&tag=merbethomgarbhg-20&linkCode=df0&creative=395093&creativeASIN=B000I9JJD2&ascsubtag=164\\_424954](https://www.amazon.com/dp/B000I9JJD2/ref=asc_df_B000I9JJD24930919?smid=ATVPDKIKX0DER&tag=merbethomgarbhg-20&linkCode=df0&creative=395093&creativeASIN=B000I9JJD2&ascsubtag=164_424954)>.\*

*Primary Examiner* — Sandra Snapp  
*Assistant Examiner* — Katherine Glennon

(57) **CLAIM**  
The ornamental design for a kitchen timer, as shown and described.

**DESCRIPTION**  
FIG. 1 is a Top Perspective view of a kitchen timer, showing our new design;  
FIG. 2 is a Top Plan view thereof,  
FIG. 3 is a Bottom Plan view thereof,  
FIG. 4 is a Front Side Elevational view thereof;  
FIG. 5 is a Rear Elevational view thereof,  
FIG. 6 is a Left Side Elevational view thereof; and,  
FIG. 7 is a Right Side Elevational view thereof.

**1 Claim, 4 Drawing Sheets**

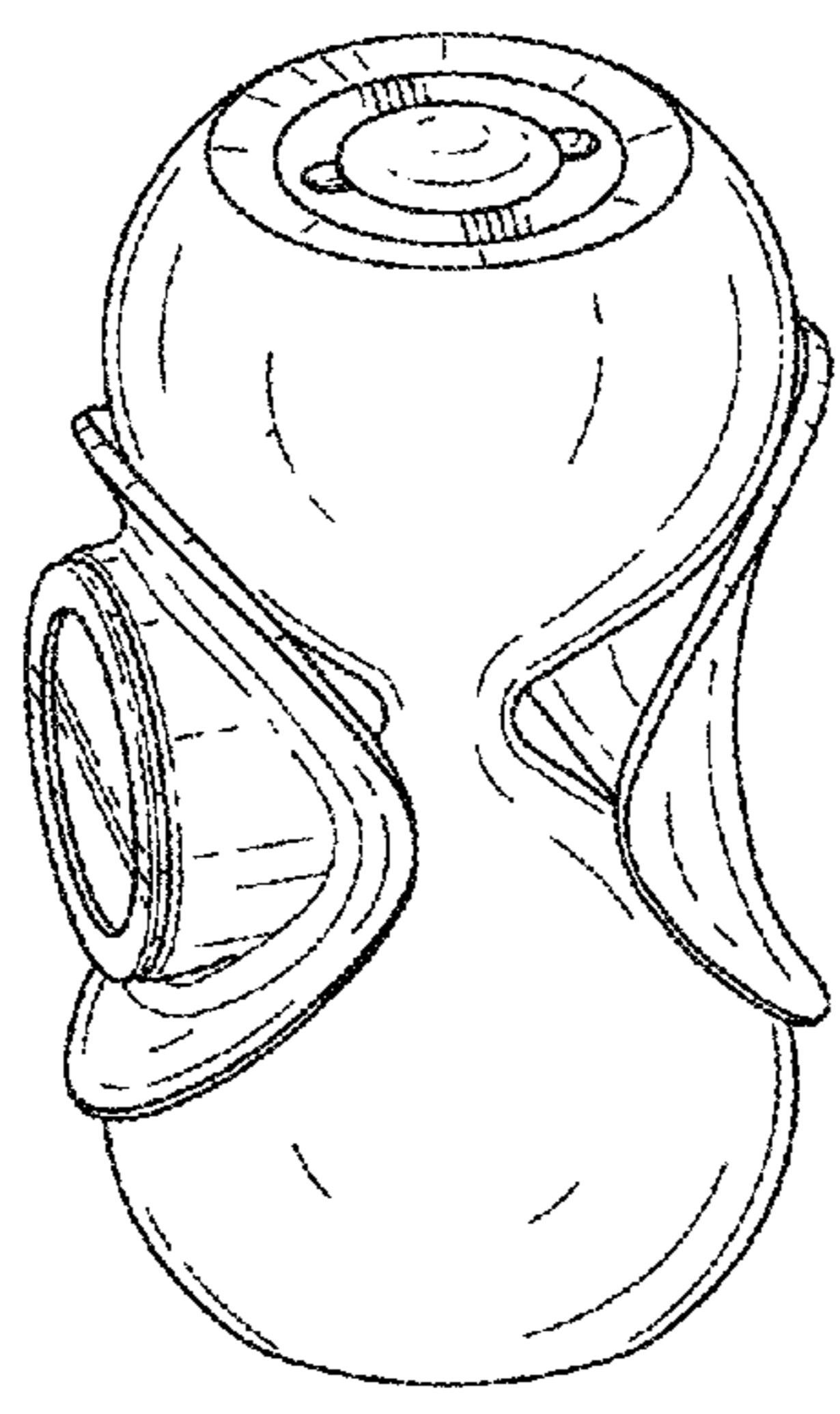

(56)

**References Cited**

U.S. PATENT DOCUMENTS

D567,673	S *	4/2008	Chu .....	D10/15
D580,791	S *	11/2008	Kuchler .....	D10/15
D588,022	S *	3/2009	Hocherman .....	D10/15
D598,787	S *	8/2009	Bedol .....	D10/15
D600,569	S *	9/2009	Sadler .....	D10/15
D602,380	S *	10/2009	Fernie .....	D10/15
D615,421	S *	5/2010	Bedol .....	D10/1
D615,878	S *	5/2010	Berliat .....	D10/22
D640,142	S *	6/2011	Bedol .....	D10/15
D670,094	S *	11/2012	Prestandrea .....	D6/351
D748,996	S *	2/2016	Bedol .....	D10/30
D757,571	S *	5/2016	Newson .....	D10/44
D758,208	S *	6/2016	Bedol .....	D10/1
D773,321	S *	12/2016	Bronwasser .....	D10/40
2007/0152799	A1 *	7/2007	McDonough .....	G04F 1/005 340/309.16
2008/0148955	A1 *	6/2008	Neace .....	A47J 31/002 99/279
2009/0185454	A1 *	7/2009	Allen .....	G04F 1/06 368/93
2011/0039135	A1 *	2/2011	Bedol .....	H01M 6/32 429/50
2015/0261193	A1 *	9/2015	Bedol .....	G04C 10/00 368/204
2016/0079586	A1 *	3/2016	Bedol .....	H01M 2/367 429/52

\* cited by examiner

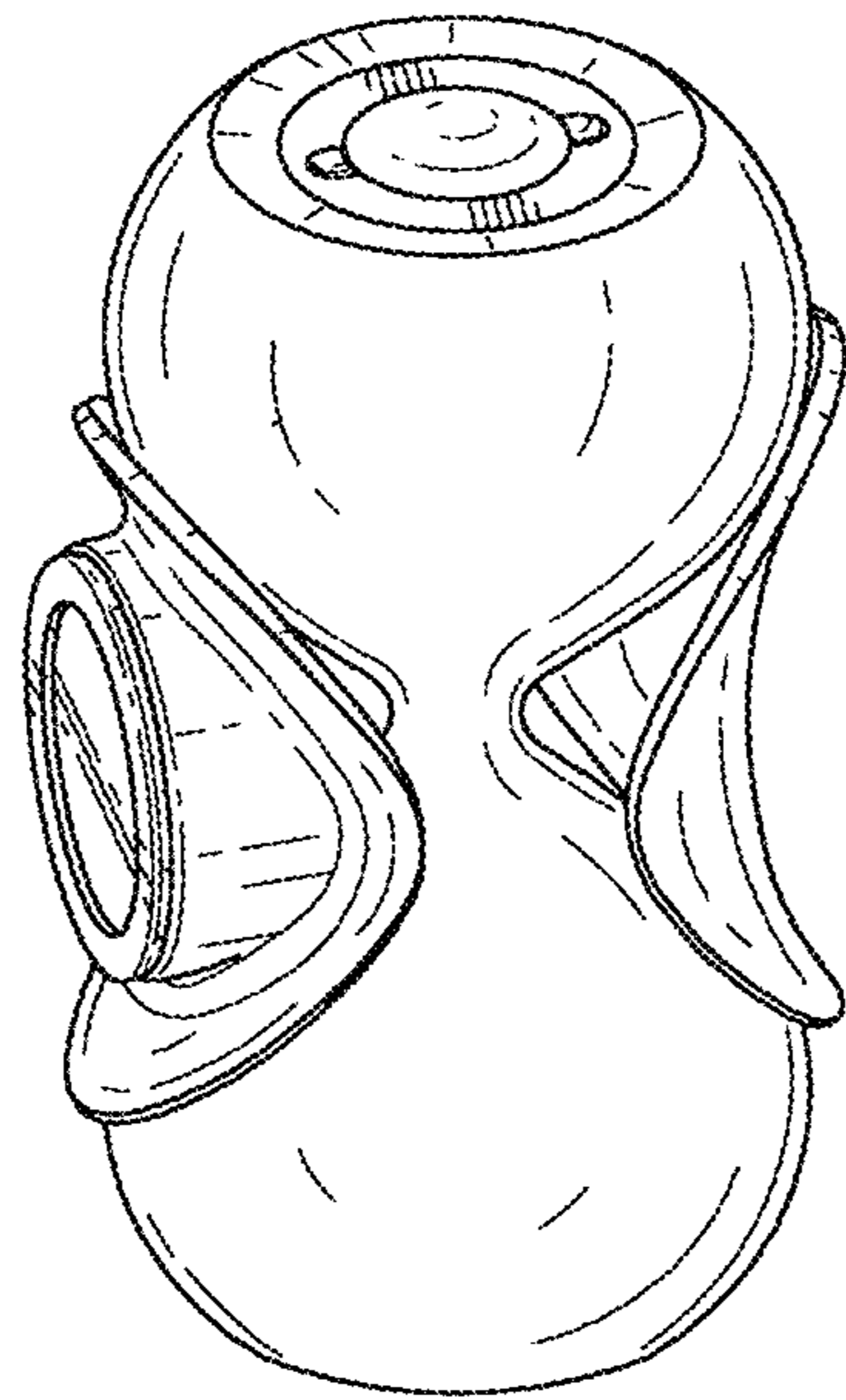

FIG. 1

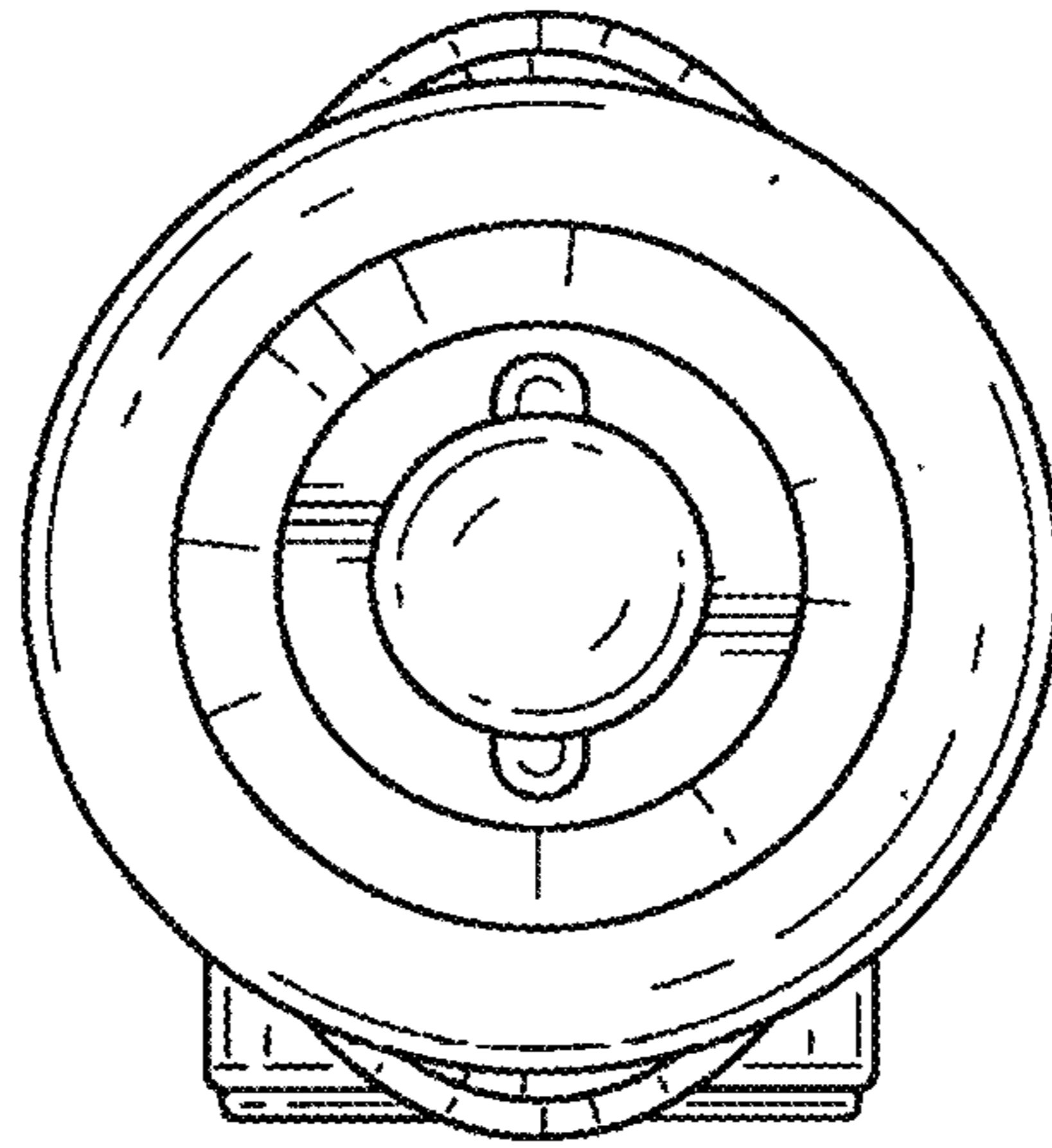

FIG. 2

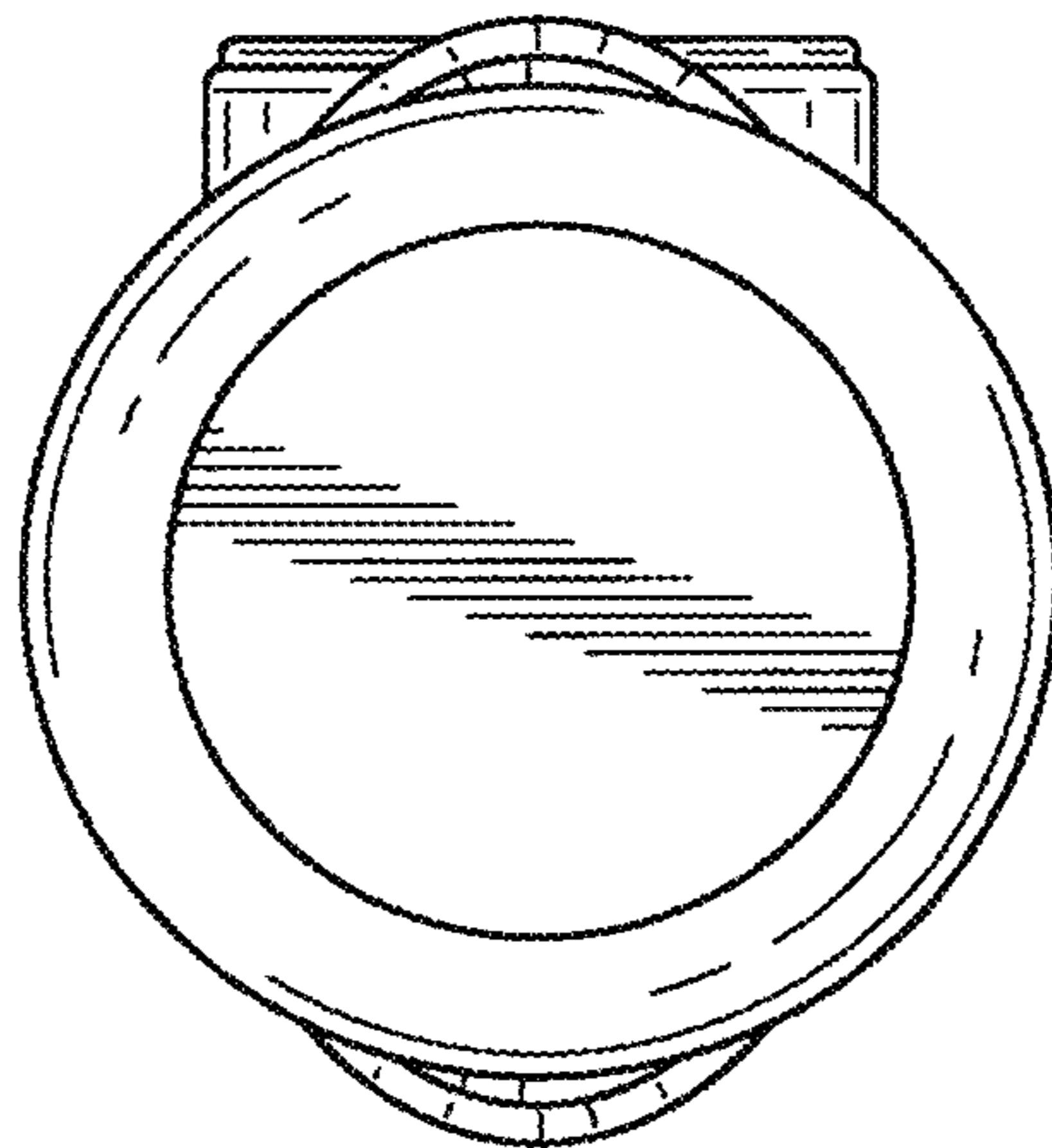

FIG. 3

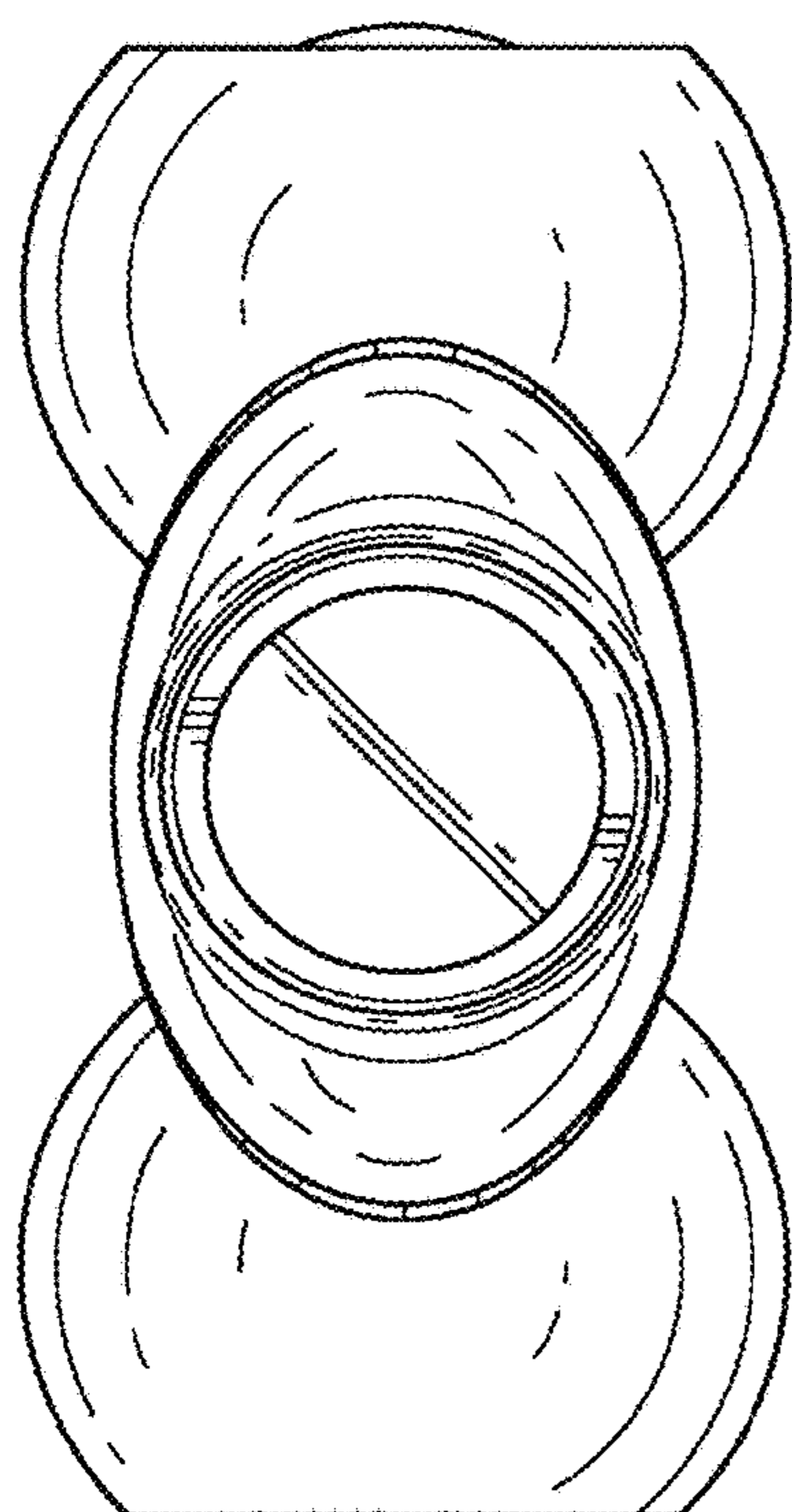

FIG. 4

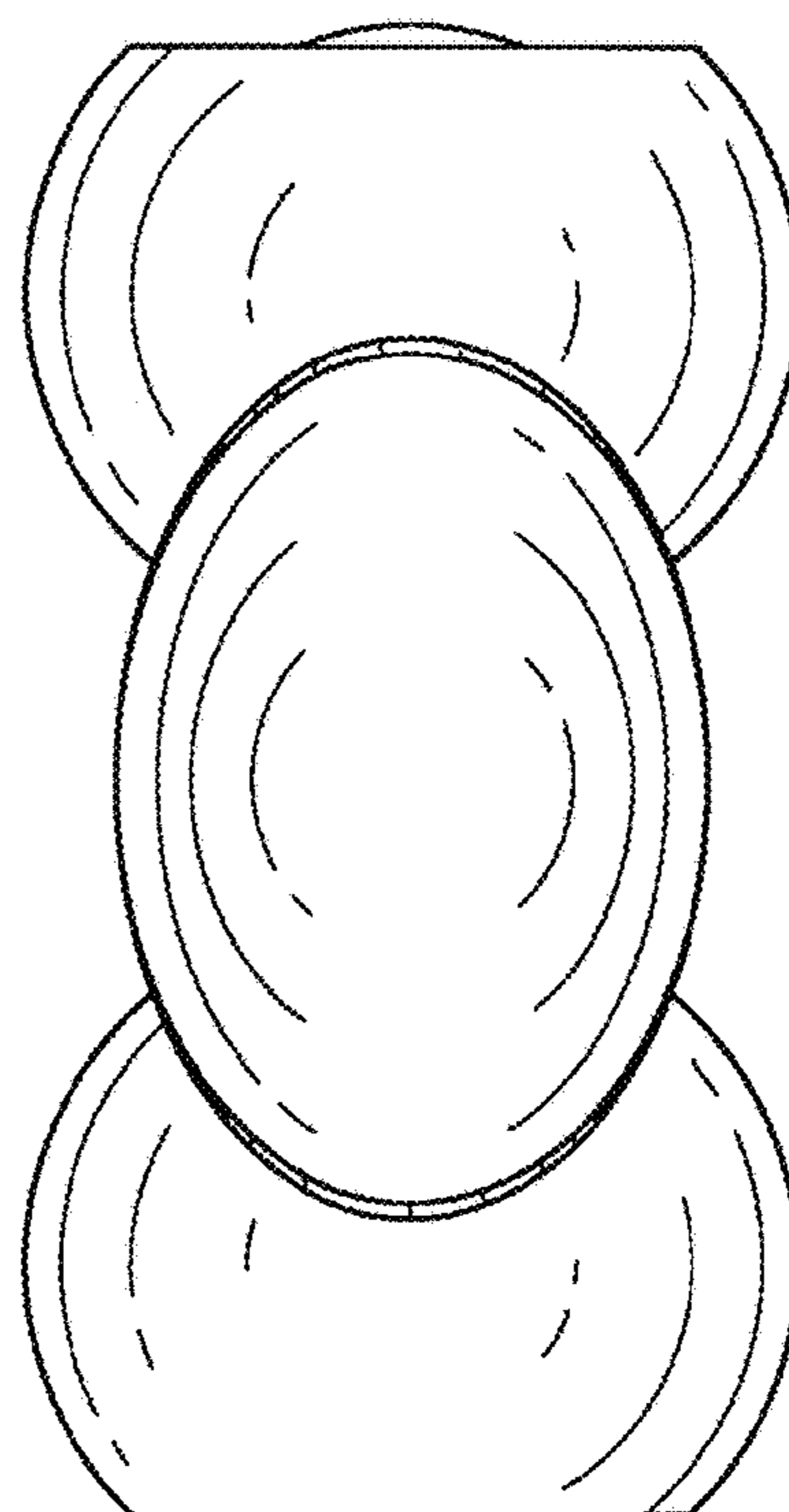

FIG. 5

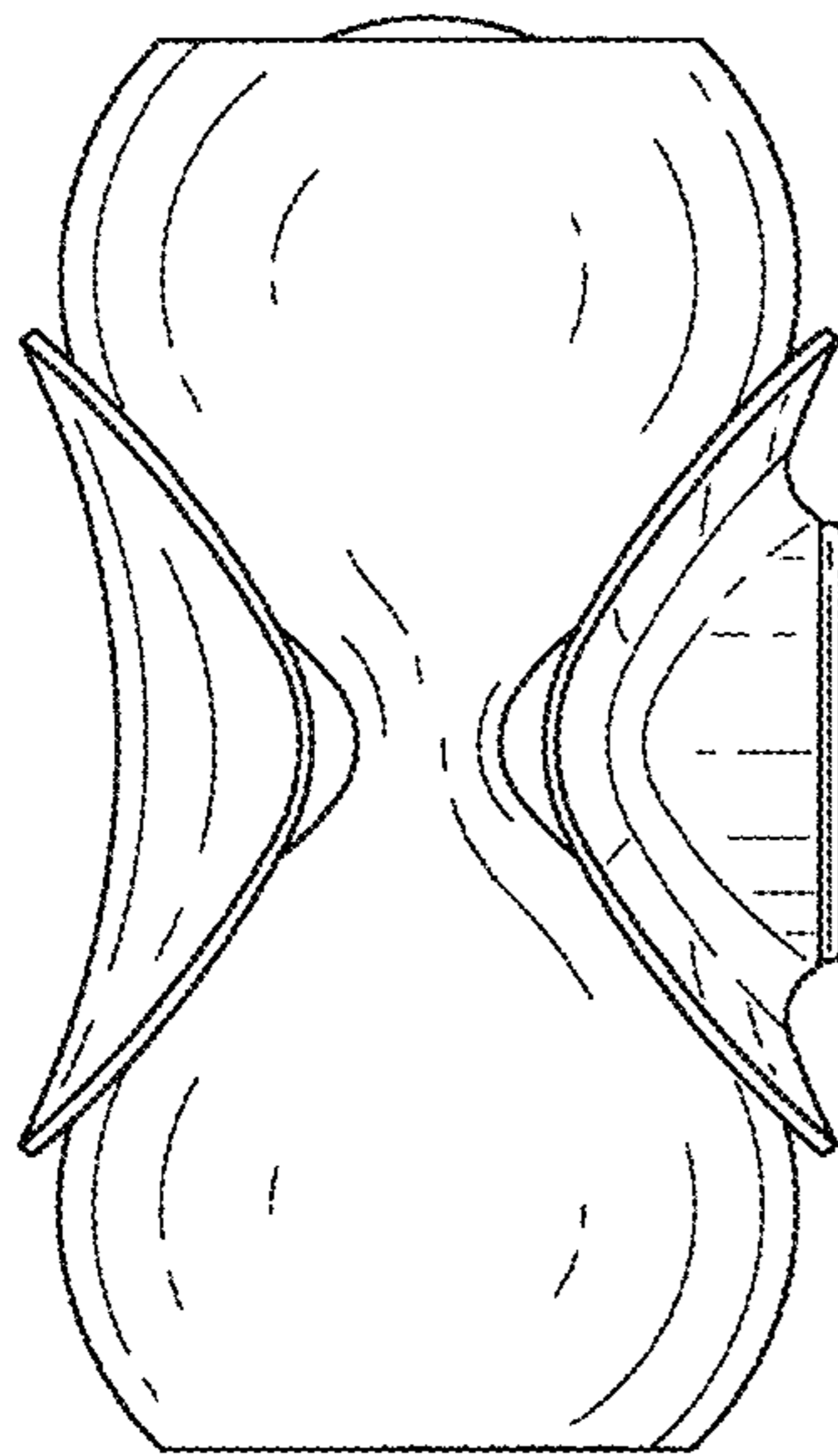

FIG. 6

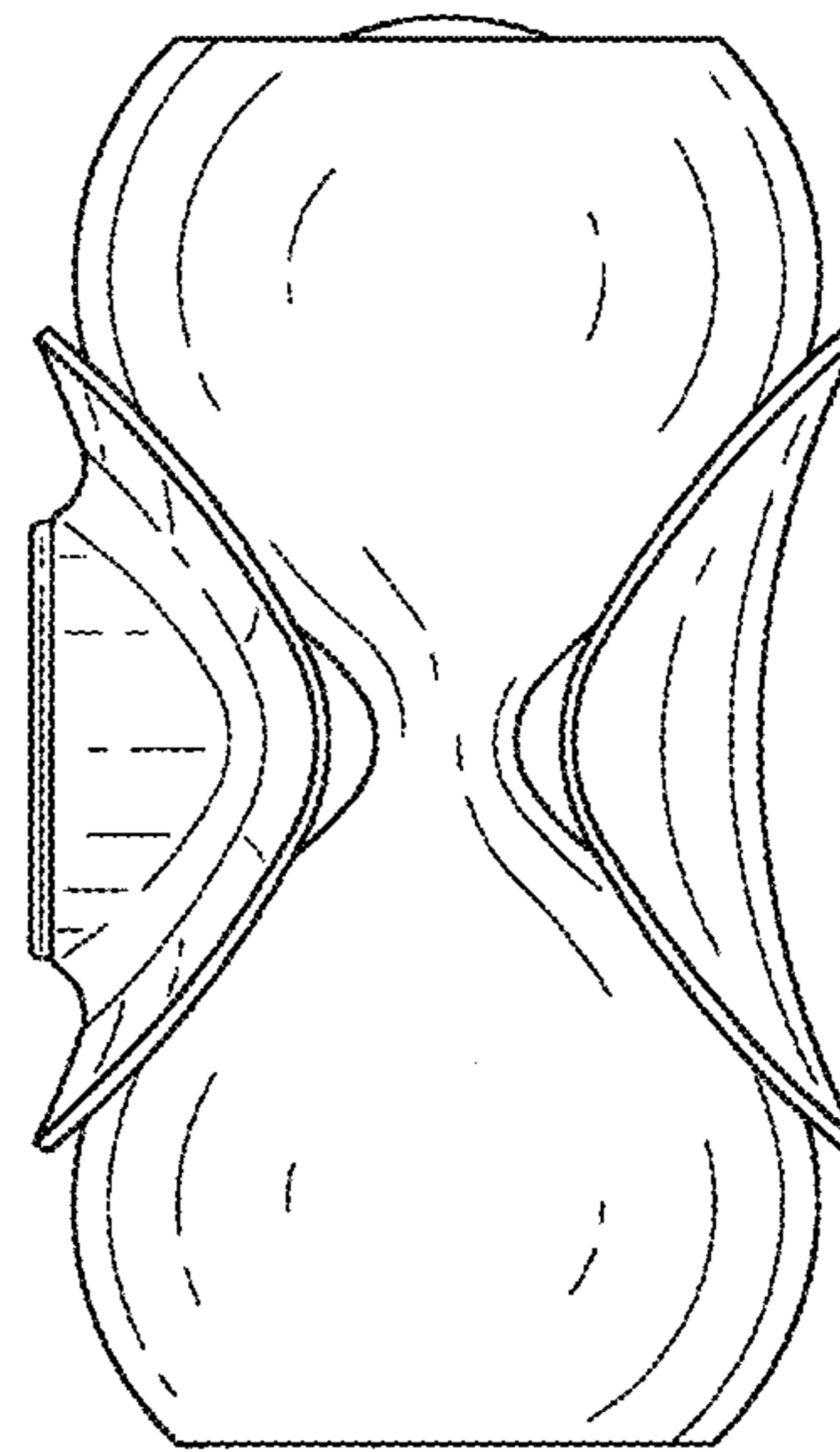

FIG. 7