



US00D807138S

(12) **United States Design Patent**
Rinner

(10) **Patent No.:** **US D807,138 S**
(45) **Date of Patent:** **** Jan. 9, 2018**

(54) **HANDLE**

(71) Applicant: **James A. Rinner**, Franksville, WI (US)

(72) Inventor: **James A. Rinner**, Franksville, WI (US)

(**) Term: **15 Years**

(21) Appl. No.: **29/529,980**

(22) Filed: **Jun. 11, 2015**

(51) **LOC (11) Cl.** **08-04**

(52) **U.S. Cl.**
USPC **D8/83**

(58) **Field of Classification Search**
USPC D8/21, 24-26, 29, 61, 82-87, 107;
81/52, 53.1, 58.3, 177.1-177.4, 438-439,
81/467, 480, 489-491
CPC B25B 13/56; B25B 15/00; B25B 15/02;
B25B 15/007; B25G 1/085; D06F 53/005;
D06F 57/00; B25F 1/04

See application file for complete search history.

(56) **References Cited**

U.S. PATENT DOCUMENTS

D393,791 S *	4/1998	Halls	D3/12
D403,228 S *	12/1998	Halls	D3/12
D403,946 S *	1/1999	Shih	D8/107
D414,099 S *	9/1999	Halls	D3/12
6,148,701 A *	11/2000	Lee	B25G 1/105 81/177.1
D446,435 S *	8/2001	Liao	D8/107
D453,674 S *	2/2002	Hsiao	D8/107
D489,488 S *	5/2004	Gaugler	D28/25
D507,466 S *	7/2005	Hu	D8/21
D517,392 S *	3/2006	Lin	D8/107
D520,824 S *	5/2006	Hsien	D8/28
D522,836 S *	6/2006	Rinner	D8/107
D556,527 S *	12/2007	Russo	D8/14
D565,380 S *	4/2008	Rinner	D8/107
7,373,860 B1 *	5/2008	Rinner	B25G 1/105 16/430

D572,564 S *	7/2008	Tilk	D8/107
D610,431 S *	2/2010	Manoucherians	D8/83
D618,534 S *	6/2010	Minkow	D8/303
D650,217 S *	12/2011	Loaiza	D7/395
D658,462 S *	5/2012	Hsieh	D8/28
D661,560 S *	6/2012	Chang	D8/28
D663,178 S *	7/2012	Tsai	D8/28
D721,554 S *	1/2015	Lin	D8/25
D730,711 S *	6/2015	Chaffee	D8/107
D746,651 S *	1/2016	Lin	D8/25
2005/0000328 A1 *	1/2005	Hsien	B25B 13/04 81/170
2016/0271786 A1 *	9/2016	Harrison	B25B 23/16

* cited by examiner

Primary Examiner — Philip S Hyder
Assistant Examiner — Roselynn Cody

(57) **CLAIM**

The ornamental design for a handle, as shown and described.

DESCRIPTION

FIG. 1 is a perspective view of the handle showing surface shading of the contours;
 FIG. 2 is a top plan view thereof, the bottom plan view being identical thereto contours;
 FIG. 3 is a front elevation view, the opposite rear elevation view being a mirror image contours;
 FIG. 4 is a front elevation view with section lines 7-7, 8-8, 9-9, 10-10, 11-11 and 12-12;
 FIG. 5 is a left elevation view;
 FIG. 6 is a right elevation view;
 FIGS. 7, 8, 9, 10, 11 and 12 are sectional views along the lines shown in FIG. 4;
 FIG. 13 is a top plan with section lines 14-14, 15-15 and 16-16;
 FIGS. 14, 15 and 16 are sectional views along the lines shown in FIG. 13.

1 Claim, 3 Drawing Sheets

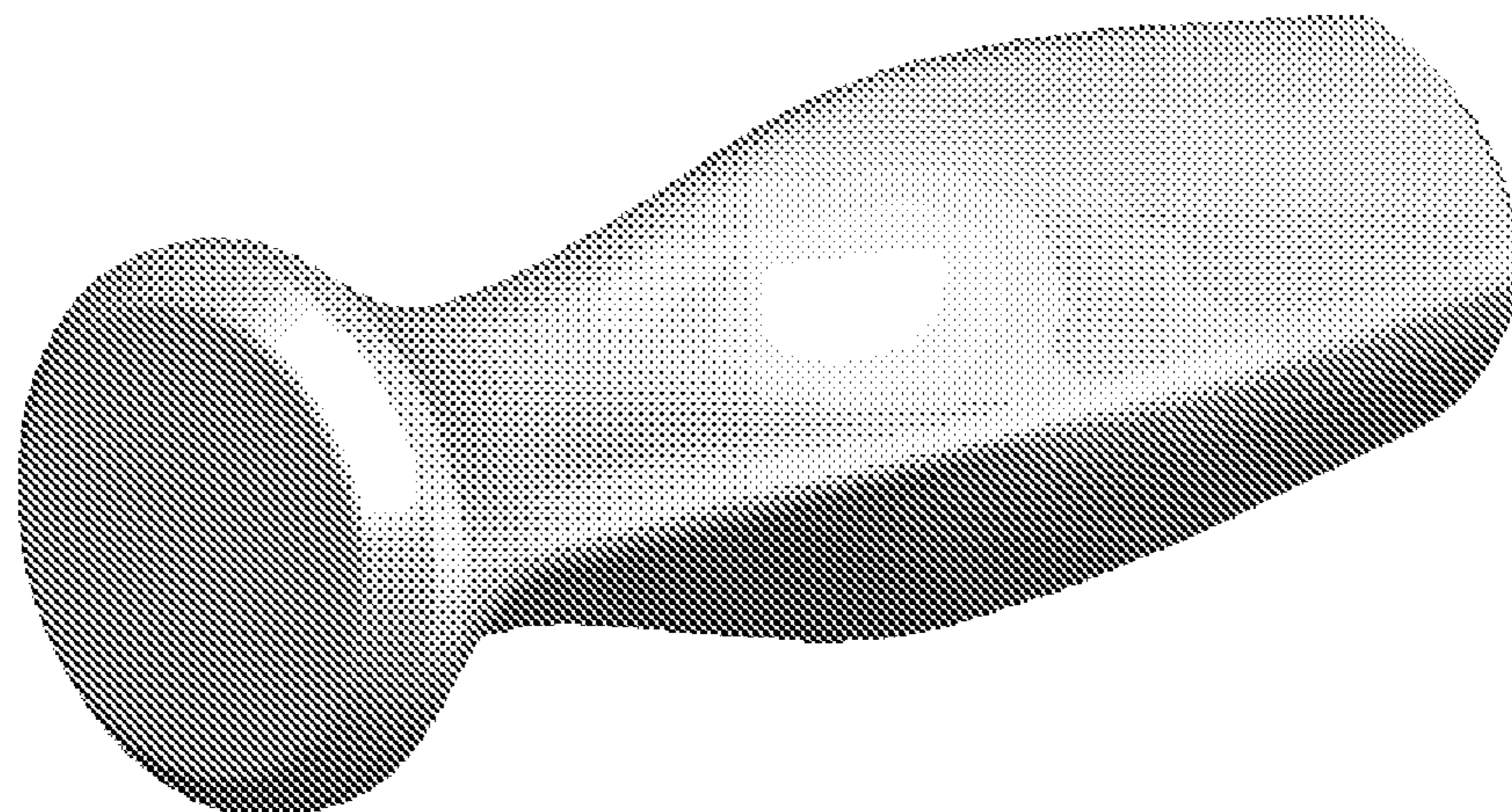

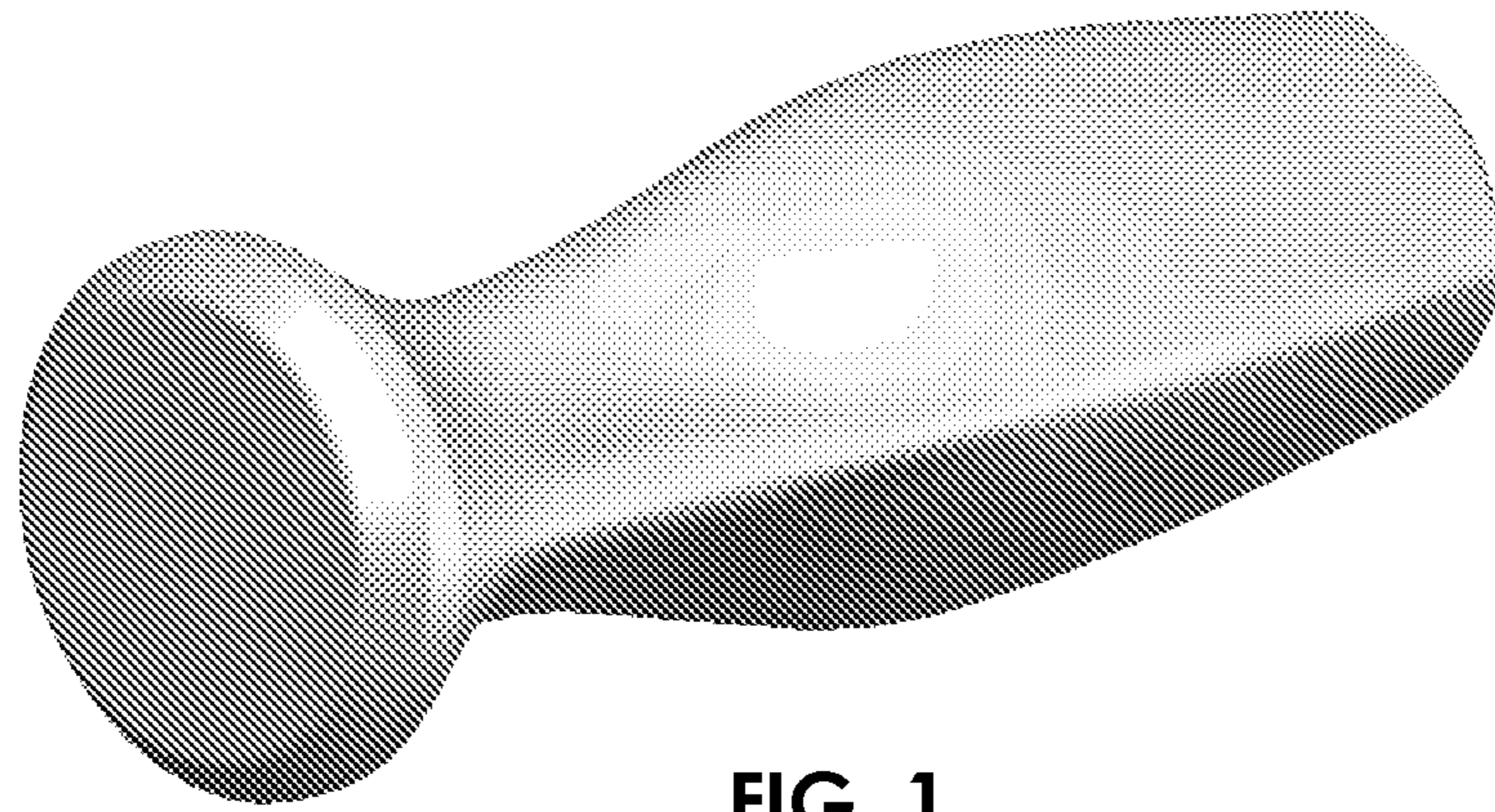

FIG. 1

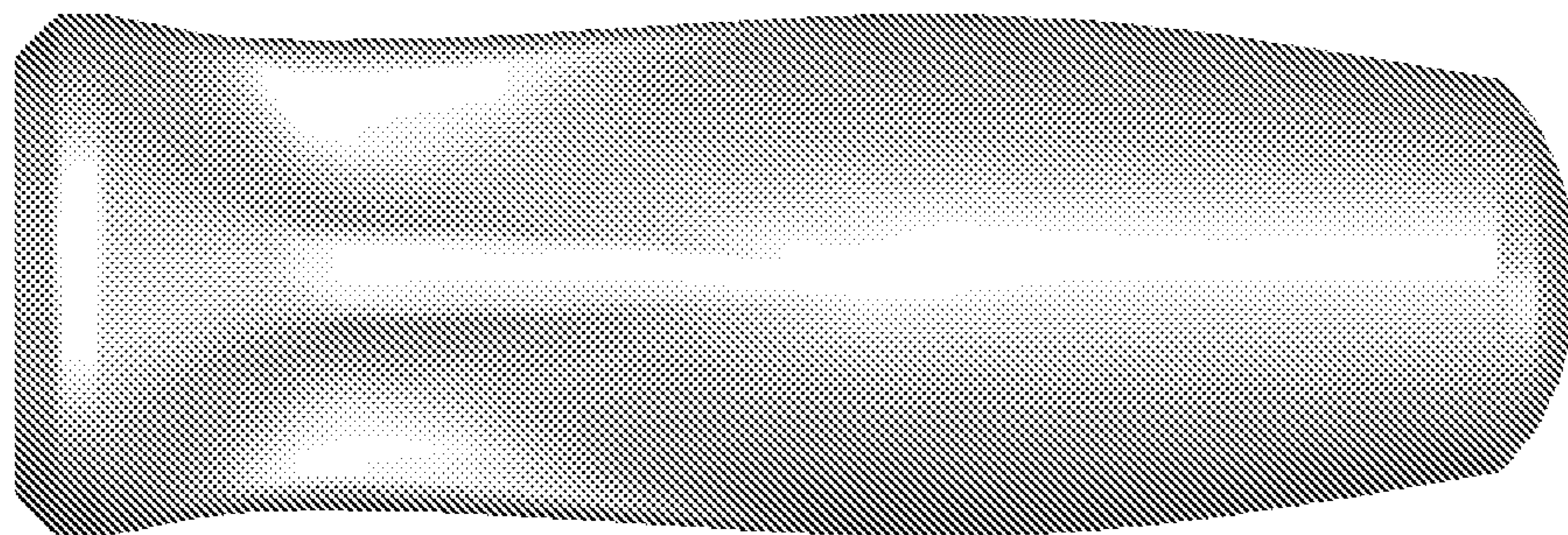

FIG. 2

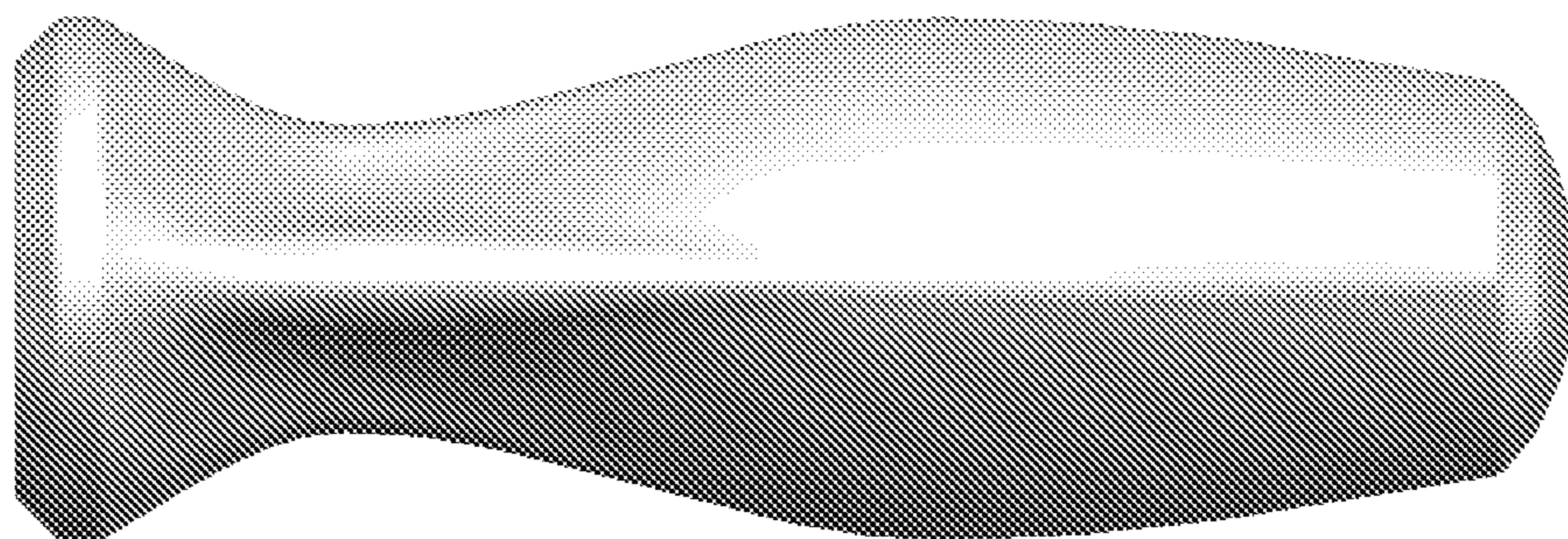
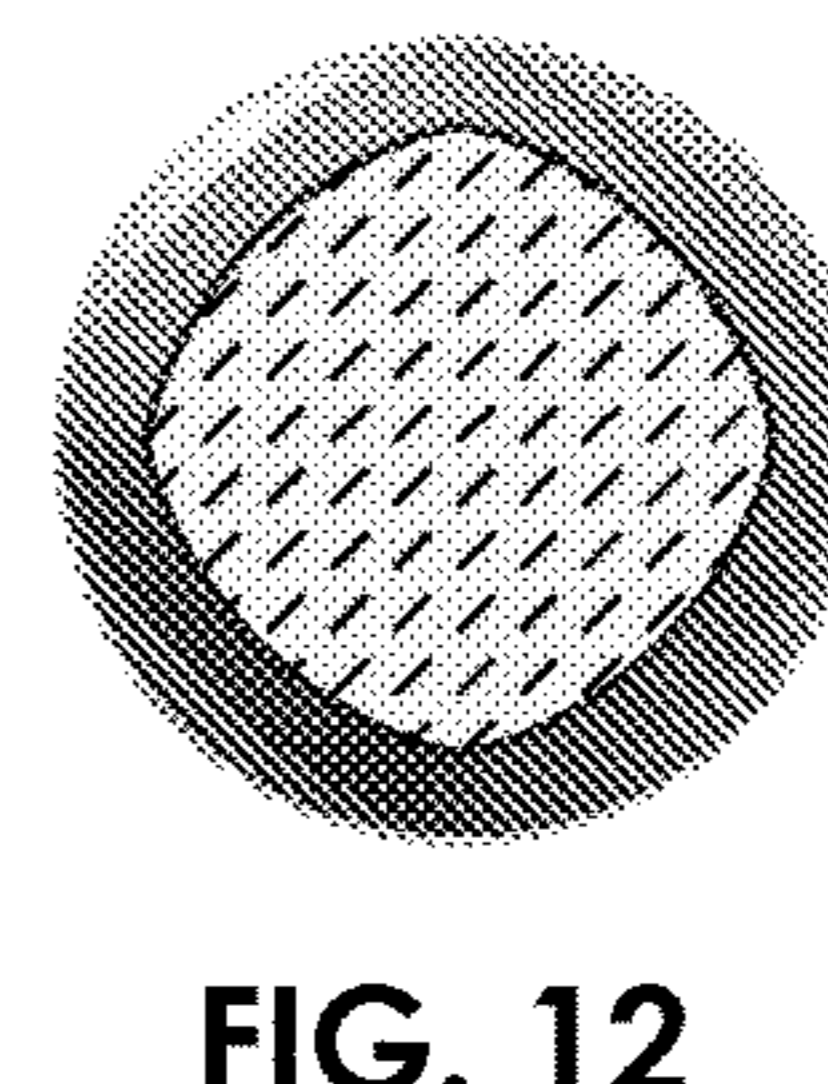
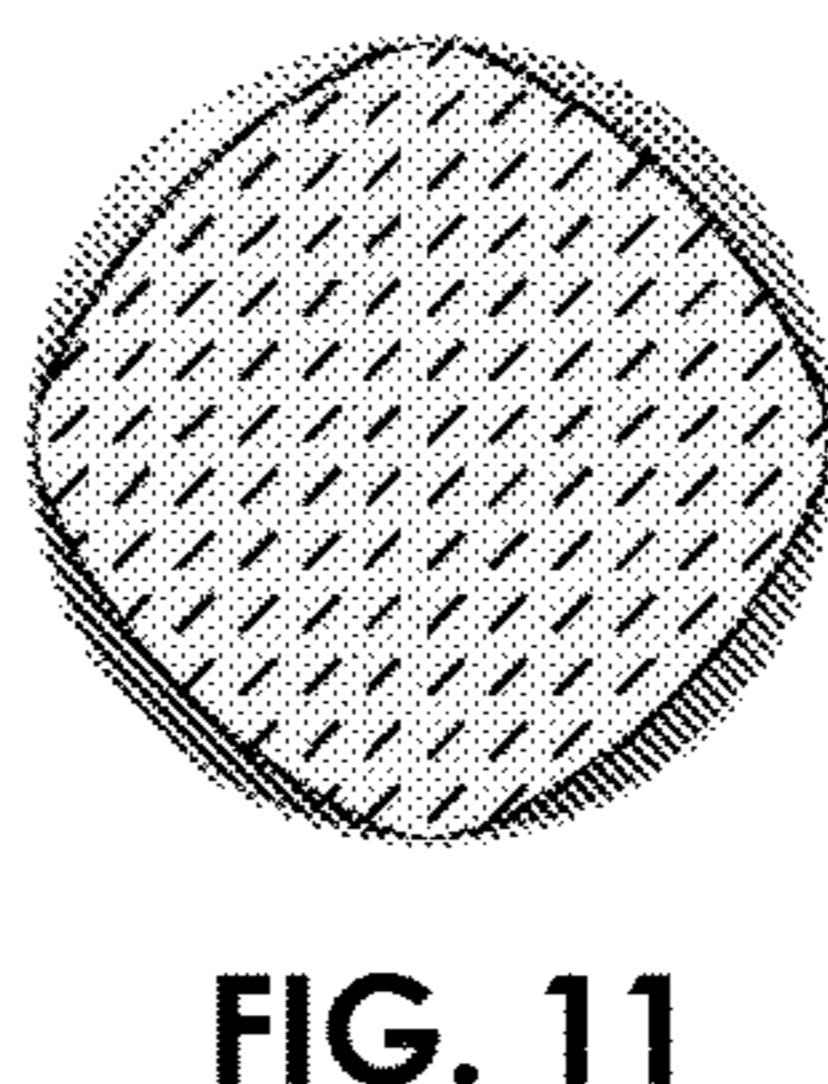
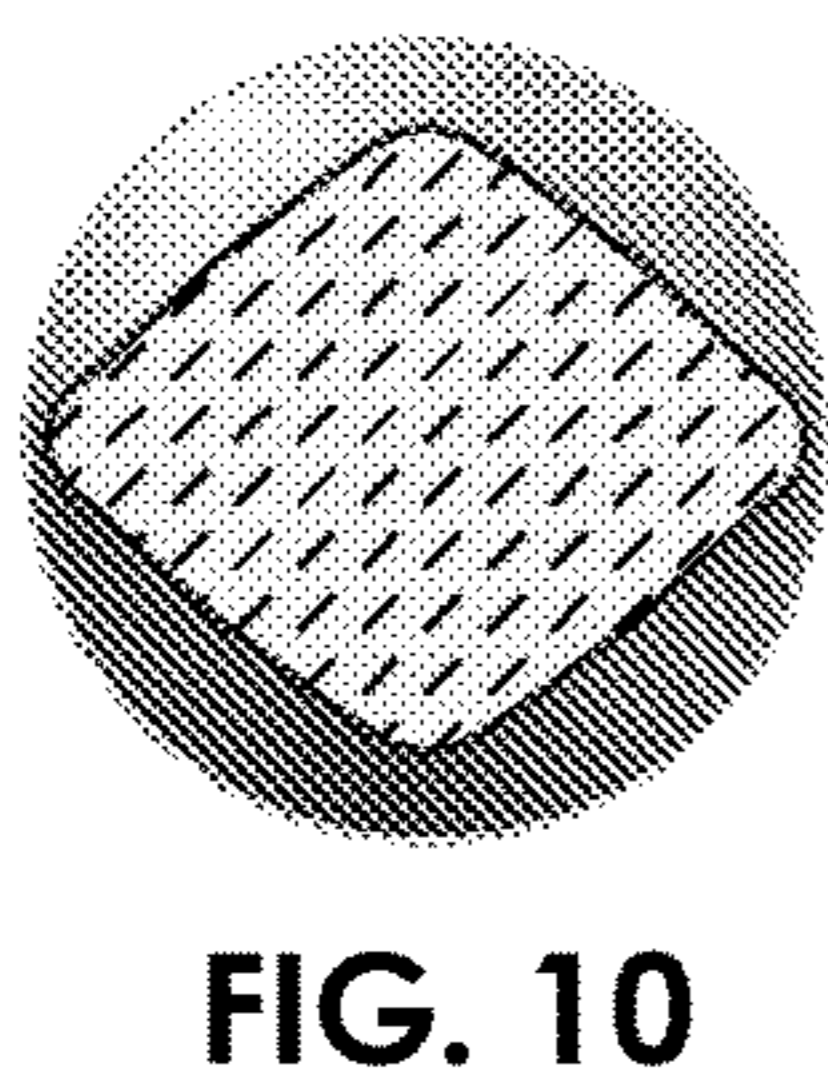
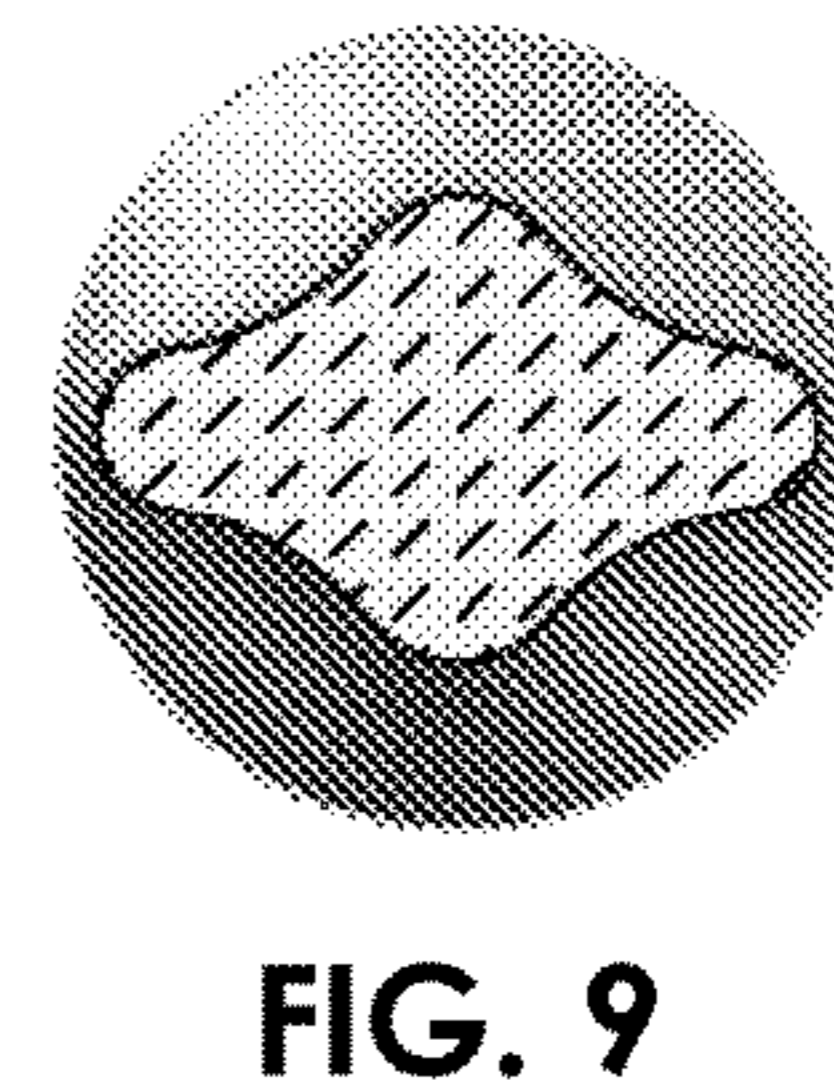
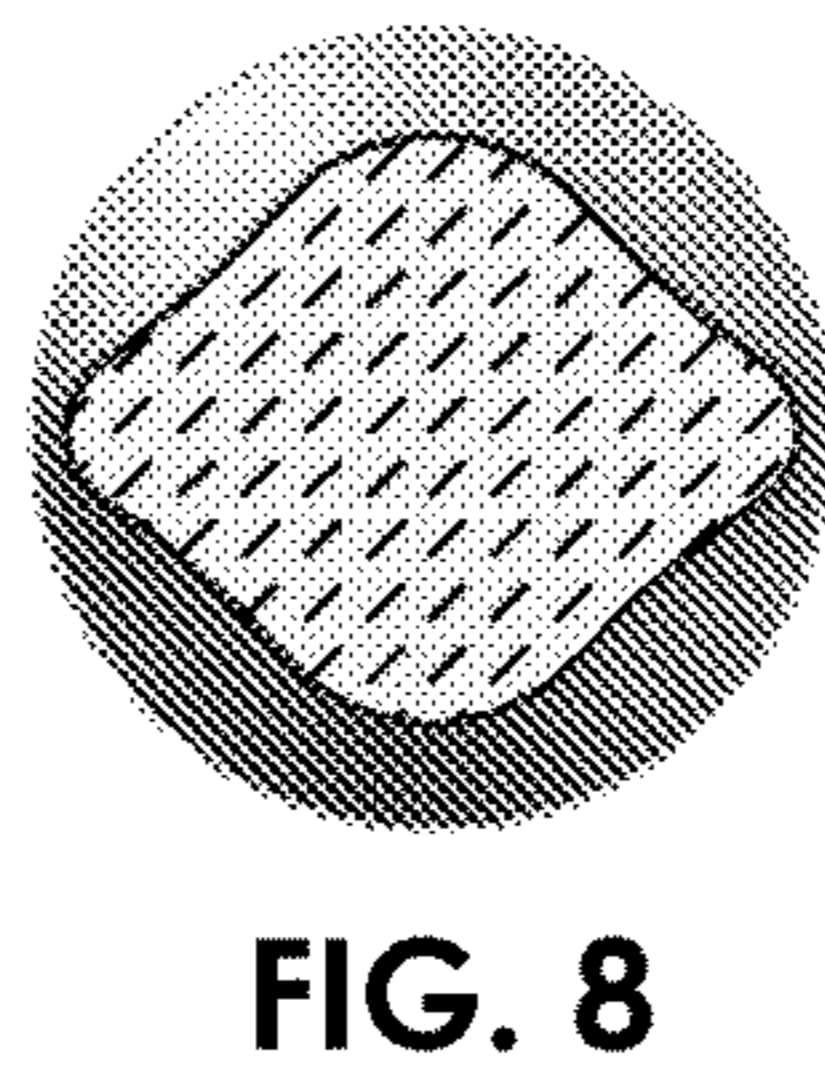
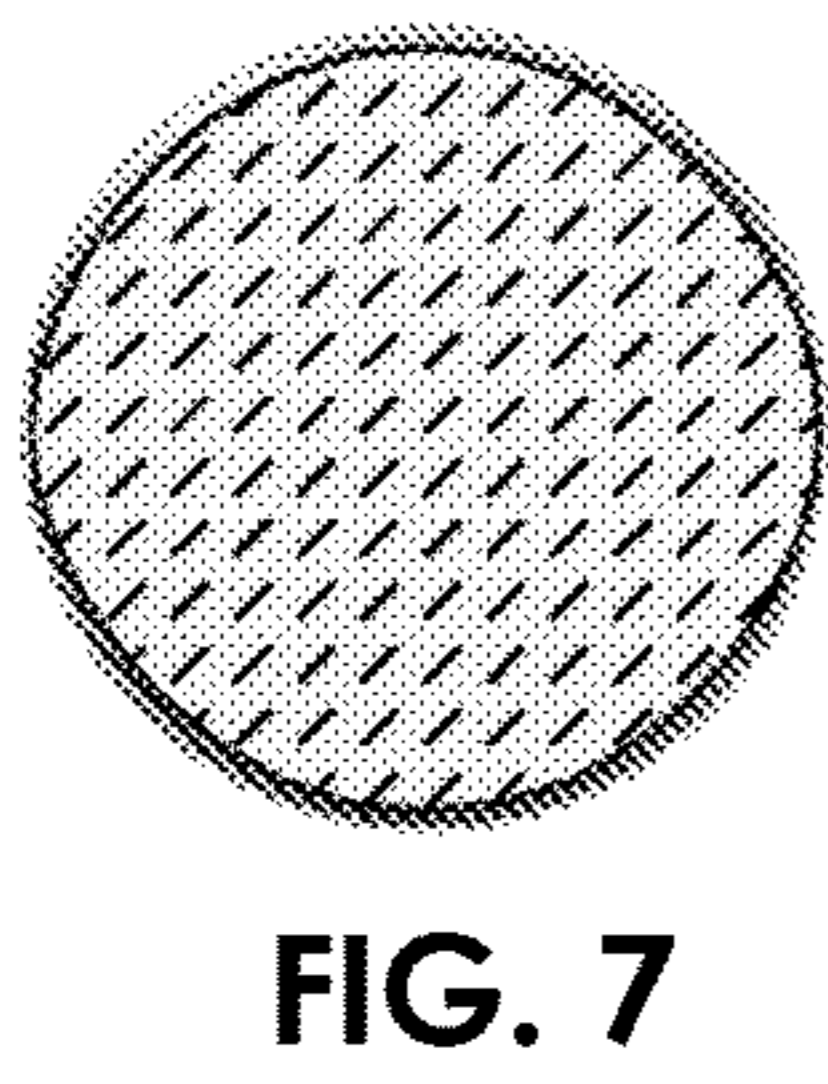
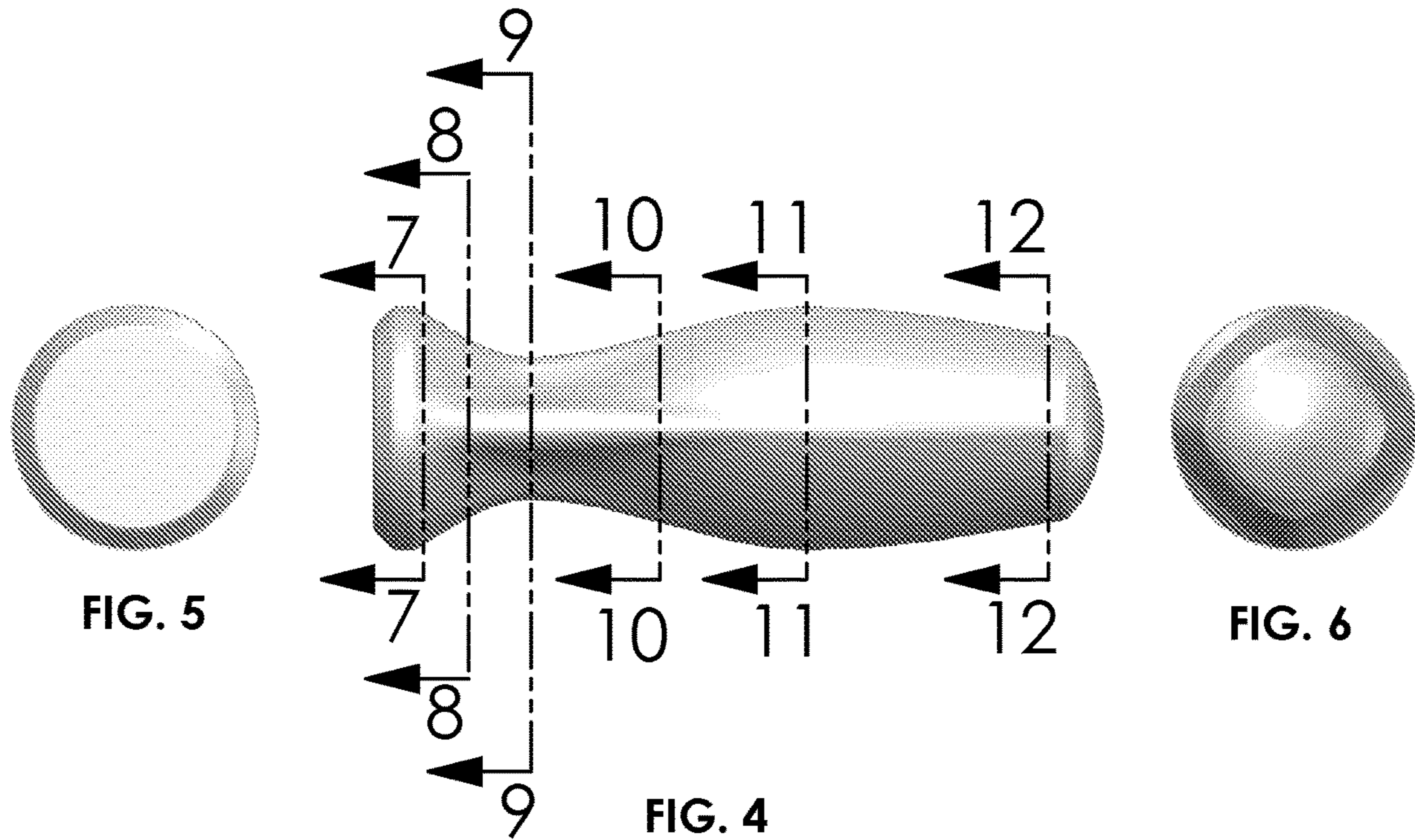

FIG. 3



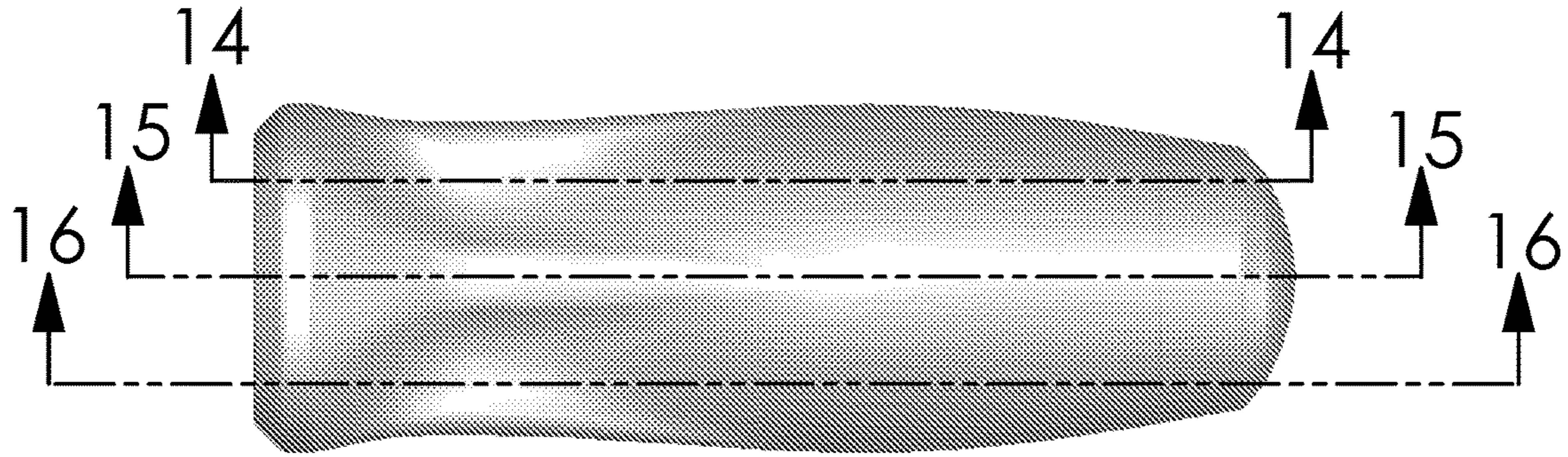

FIG. 13

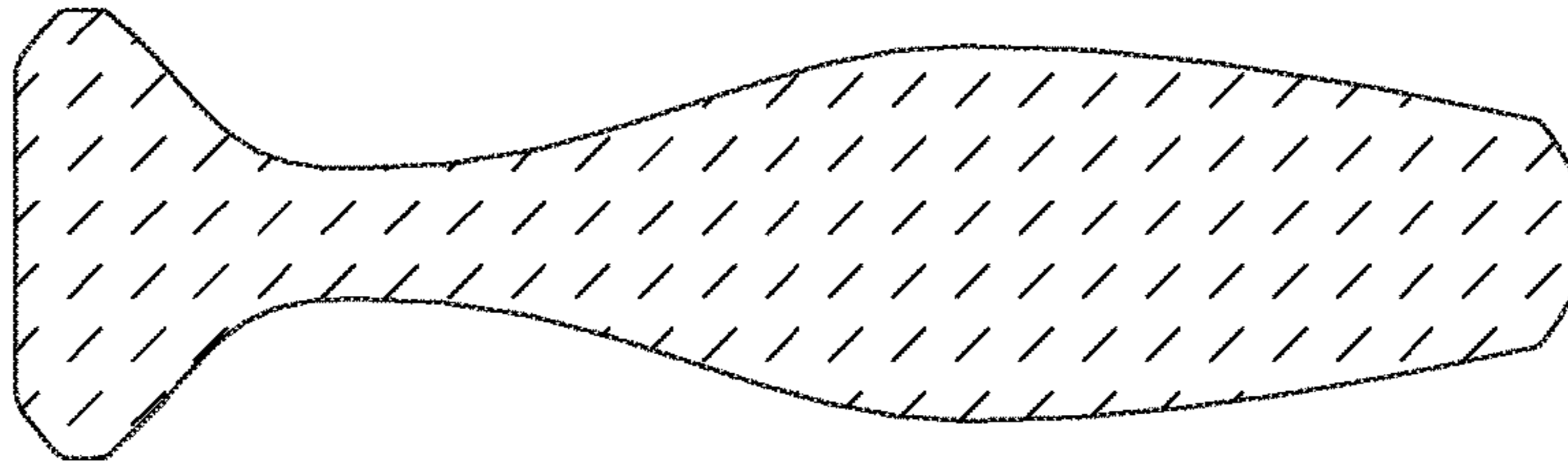

FIG. 14

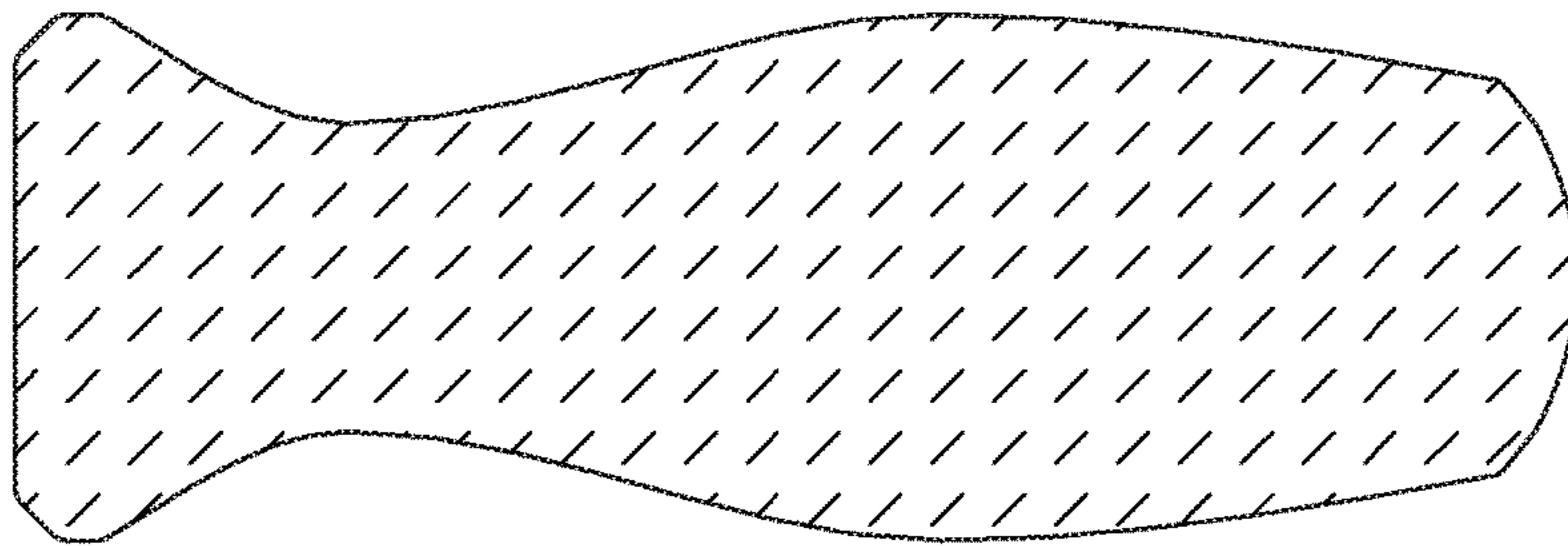

FIG. 15

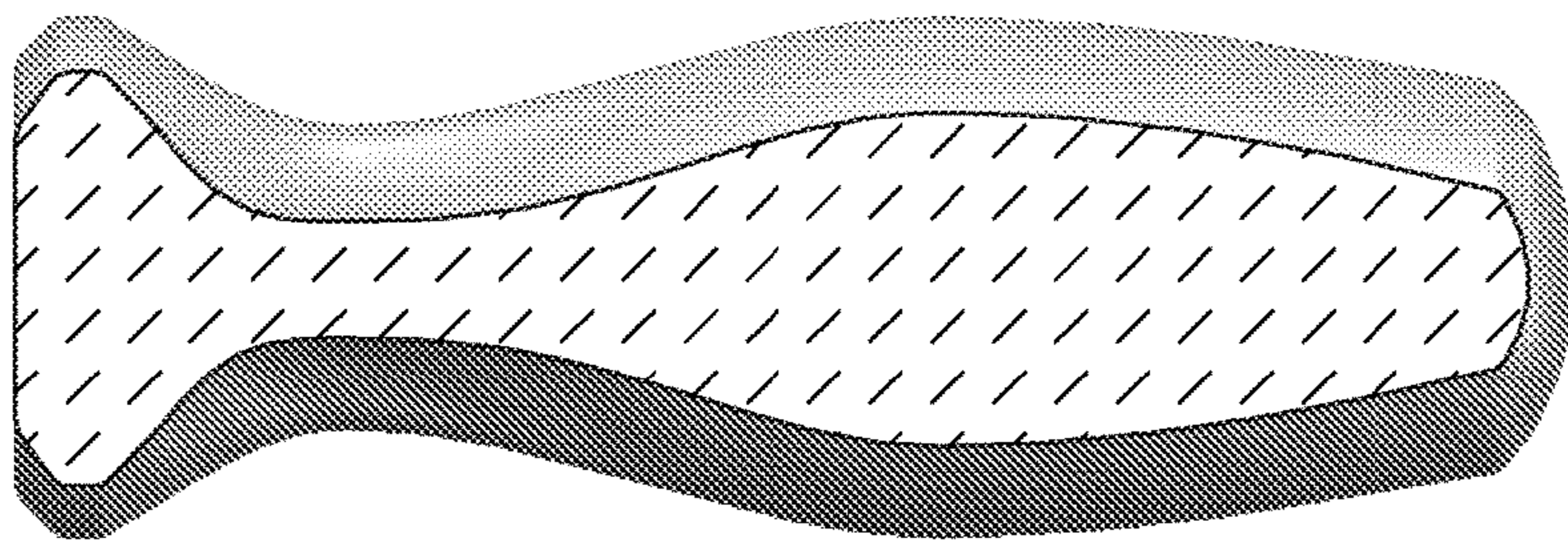

FIG. 16