



US00D807124S

(12) **United States Design Patent**  
**Carey et al.**

(10) **Patent No.:** **US D807,124 S**  
(45) **Date of Patent:** **\*\* Jan. 9, 2018**

(54) **COOLER**

D259,232 S 5/1981 Tarozzi  
D266,822 S 11/1982 Seager  
D270,604 S 9/1983 Zauft

(71) Applicant: **CHARD INTERNATIONAL, LLC.**,  
Two Rivers, WI (US)

(Continued)

(72) Inventors: **Richard Carey**, Two Rivers, WI (US);  
**Ross Niemi**, Chicago, IL (US)

*Primary Examiner* — Terry Wallace

(74) *Attorney, Agent, or Firm* — Seager, Tufte &  
Wickhem LLP

(73) Assignee: **The Metal Ware Corporation**, Two  
Rivers, WI (US)

(57) **CLAIM**

The ornamental design for a cooler, as shown and described.

(\*\*) Term: **15 Years**

(21) Appl. No.: **29/575,935**

**DESCRIPTION**

(22) Filed: **Aug. 30, 2016**

**Related U.S. Application Data**

(63) Continuation-in-part of application No. 29/553,277,  
filed on Jan. 29, 2016.

(51) **LOC (11) Cl.** ..... **07-01**

(52) **U.S. Cl.**  
USPC ..... **D7/605**

(58) **Field of Classification Search**  
USPC ..... D7/605–608  
CPC ... A45C 11/20; F25D 3/08; F25D 3/14; F25D  
2331/804; B65D 81/3823; A47J 41/022;  
A47G 19/2288

See application file for complete search history.

(56) **References Cited**

**U.S. PATENT DOCUMENTS**

1,483,953 A 2/1924 Rainey  
D70,542 S 7/1926 Davis et al.  
1,699,313 A 1/1929 Schlaich  
2,960,216 A 11/1960 Brady  
D210,795 S 4/1968 Birger et al.  
3,782,765 A 1/1974 Wallyn  
D232,798 S 9/1974 Roche  
D237,135 S 10/1975 Wiant et al.  
D257,934 S 1/1981 Buss

FIG. 1 is a top perspective view of an embodiment of a cooler;

FIG. 2 is a front side view of the cooler of FIG. 1;

FIG. 3 is a back side view of the cooler of FIG. 1;

FIG. 4 is a left side view of the cooler of FIG. 1;

FIG. 5 is a right side view of the cooler of FIG. 1;

FIG. 6 is a top side view of the cooler of FIG. 1;

FIG. 7 is a bottom side view of the cooler of FIG. 1;

FIG. 8 is a top perspective view of a further embodiment of a cooler;

FIG. 9 is a front side view of the cooler of FIG. 8;

FIG. 10 is a back side view of the cooler of FIG. 8;

FIG. 11 is a left side view of the cooler of FIG. 8;

FIG. 12 is a right side view of the cooler of FIG. 8;

FIG. 13 is a top side view of the cooler of FIG. 8;

FIG. 14 is a bottom side view of the cooler of FIG. 8;

FIG. 15 is a top perspective view of a further embodiment of a cooler;

FIG. 16 is a front side view of the cooler of FIG. 15;

FIG. 17 is a back side view of the cooler of FIG. 15;

FIG. 18 is a left side view of the cooler of FIG. 15;

FIG. 19 is a right side view of the cooler of FIG. 15;

FIG. 20 is a top side view of the cooler of FIG. 15; and,

FIG. 21 is a bottom side view of the cooler of FIG. 15.

The broken lines in the drawings illustrate portions in the article that form no part of the claim.

**1 Claim, 21 Drawing Sheets**

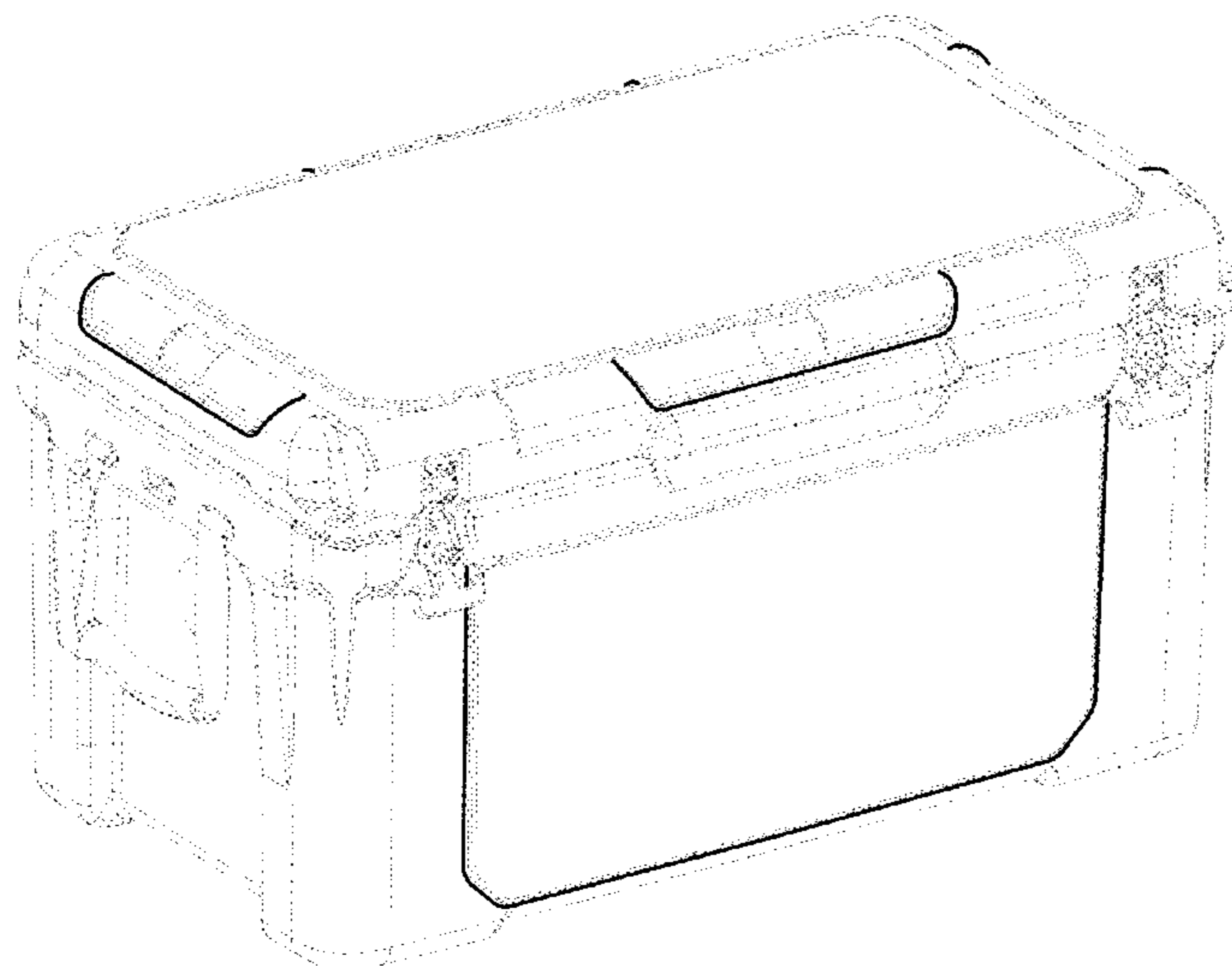

(56)

References Cited

U.S. PATENT DOCUMENTS

D281,695 S	12/1985	Ryan, Jr.	D467,470 S	12/2002	Cantor et al.
D283,480 S	4/1986	Bailey	D467,770 S	12/2002	Blalock
D283,966 S	5/1986	Carlson	D475,248 S	6/2003	Cantor et al.
D291,858 S	9/1987	Baker et al.	D486,457 S	2/2004	Leba et al.
4,702,504 A	10/1987	Brothers	D494,021 S	8/2004	Huthmaker
D305,397 S	1/1990	Balius	D511,247 S	11/2005	Tsuchiya
D307,998 S	5/1990	Costello et al.	D511,624 S	11/2005	Rosine et al.
D322,198 S	12/1991	Dringenburg	D521,810 S	5/2006	Estes
D325,323 S *	4/1992	Kahl ..... D7/605	D527,225 S *	8/2006	Krieger ..... D7/605
D325,324 S	4/1992	Kahl	D528,368 S	9/2006	Maldonado
D325,853 S	5/1992	Kahl	D552,426 S *	10/2007	Jones ..... D7/605
D328,221 S	7/1992	Piccarillo	D560,102 S	1/2008	Sumter
D328,689 S	8/1992	Riskowski	D563,731 S	3/2008	Thurston
D330,329 S	10/1992	Brightbill	D566,479 S *	4/2008	Kabalin ..... D3/273
D333,775 S	3/1993	Krape	D575,059 S	8/2008	Cappiello et al.
D334,868 S	4/1993	Lau Woon	D587,972 S	3/2009	Dorisca et al.
D340,167 S	10/1993	Kahl	7,533,782 B2	5/2009	Parker et al.
D340,620 S	10/1993	Peters	7,540,364 B2	6/2009	Sanderson
D349,007 S	7/1994	Costello	D604,994 S	12/2009	Greenlees
D351,318 S	10/1994	Wedi	D613,109 S	4/2010	Sanchez et al.
D352,208 S	11/1994	Brookshire	D613,560 S	4/2010	Robichaud et al.
D353,304 S	12/1994	Friedrich	7,722,204 B1	5/2010	Sandberg
D354,419 S *	1/1995	Kahl ..... D7/605	D634,982 S	3/2011	Melchert et al.
D366,599 S	1/1996	Brown et al.	D637,459 S	5/2011	Giese
D369,722 S	5/1996	Lopez, Jr. et al.	D640,102 S	6/2011	Hawkins
D370,159 S	5/1996	Fenton et al.	D645,248 S	9/2011	Osiecki et al.
D374,772 S *	10/1996	Hotaling ..... D3/273	D646,528 S	10/2011	Stallman et al.
D376,068 S	12/1996	Coy	D651,860 S *	1/2012	Nie ..... D7/605
5,607,195 A	3/1997	Antonucci	D652,262 S *	1/2012	Yang ..... D7/605
D380,369 S	7/1997	Antonucci	D660,885 S	5/2012	Crawford
D386,649 S	11/1997	Arnfelt	8,210,702 B1	7/2012	Sandberg
5,683,097 A	11/1997	Fenton et al.	D694,070 S	11/2013	Torres
5,735,428 A	4/1998	Chern	D712,720 S	9/2014	Seiders
5,738,238 A	4/1998	Yang	D712,721 S	9/2014	Seiders
5,742,990 A	4/1998	Antonucci	D712,722 S	9/2014	Seiders
D394,550 S	5/1998	Tanji	D712,723 S	9/2014	Seiders
D396,779 S	8/1998	Moffett, III et al.	D714,125 S	9/2014	Seiders
D397,585 S	9/1998	Rausch et al.	8,887,515 B2 *	11/2014	Patstone ..... F25D 3/08 62/457.2
D398,816 S	9/1998	Koutsouflakis	8,910,819 B2	12/2014	Seiders
D407,609 S	4/1999	Rausch	9,187,232 B2	11/2015	Seiders
D415,393 S	10/1999	Kei	D747,950 S	1/2016	Jacobsen et al.
D415,658 S	10/1999	Frehse	D747,951 S	1/2016	Jacobsen et al.
D421,552 S	3/2000	Frehse	D748,452 S	2/2016	Jacobsen et al.
D423,294 S	4/2000	Klein et al.	D750,953 S	3/2016	Jacobsen et al.
D429,606 S	8/2000	Israel et al.	2008/0025544 A1	1/2008	Maldonado
D437,736 S	2/2001	Moffett, III et al.	2008/0110892 A1	5/2008	House
D439,406 S	3/2001	Zimmerman	2009/0139245 A1 *	6/2009	Blackway ..... F25B 21/02 62/3.62
D439,913 S	4/2001	Jobst	2011/0203297 A1	8/2011	Oberweis
D454,292 S	3/2002	Plummer et al.	2012/0132657 A1	5/2012	Seiders
6,398,272 B1	6/2002	Plummer et al.	2014/0252010 A1	9/2014	Miller

\* cited by examiner

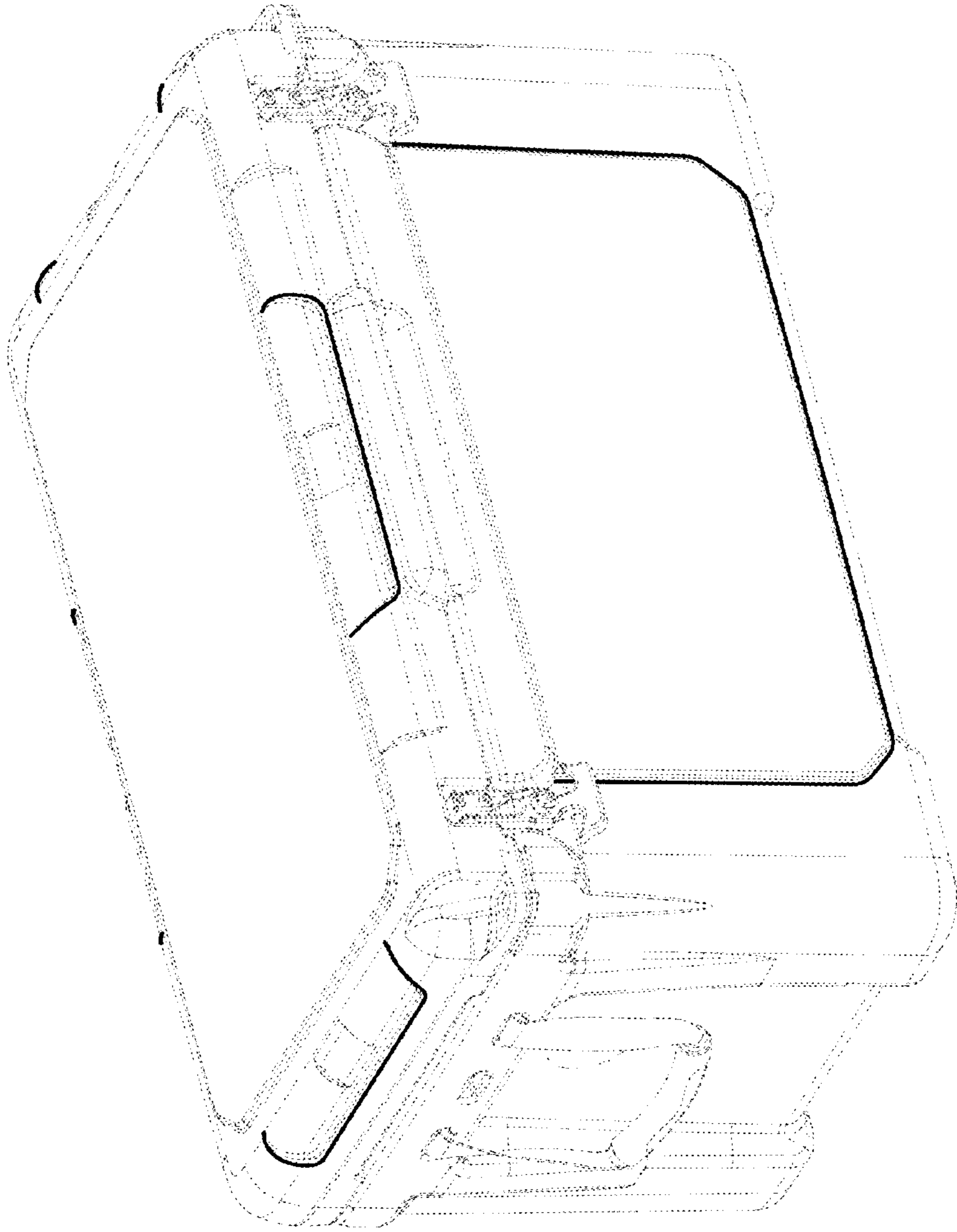

Figure 1

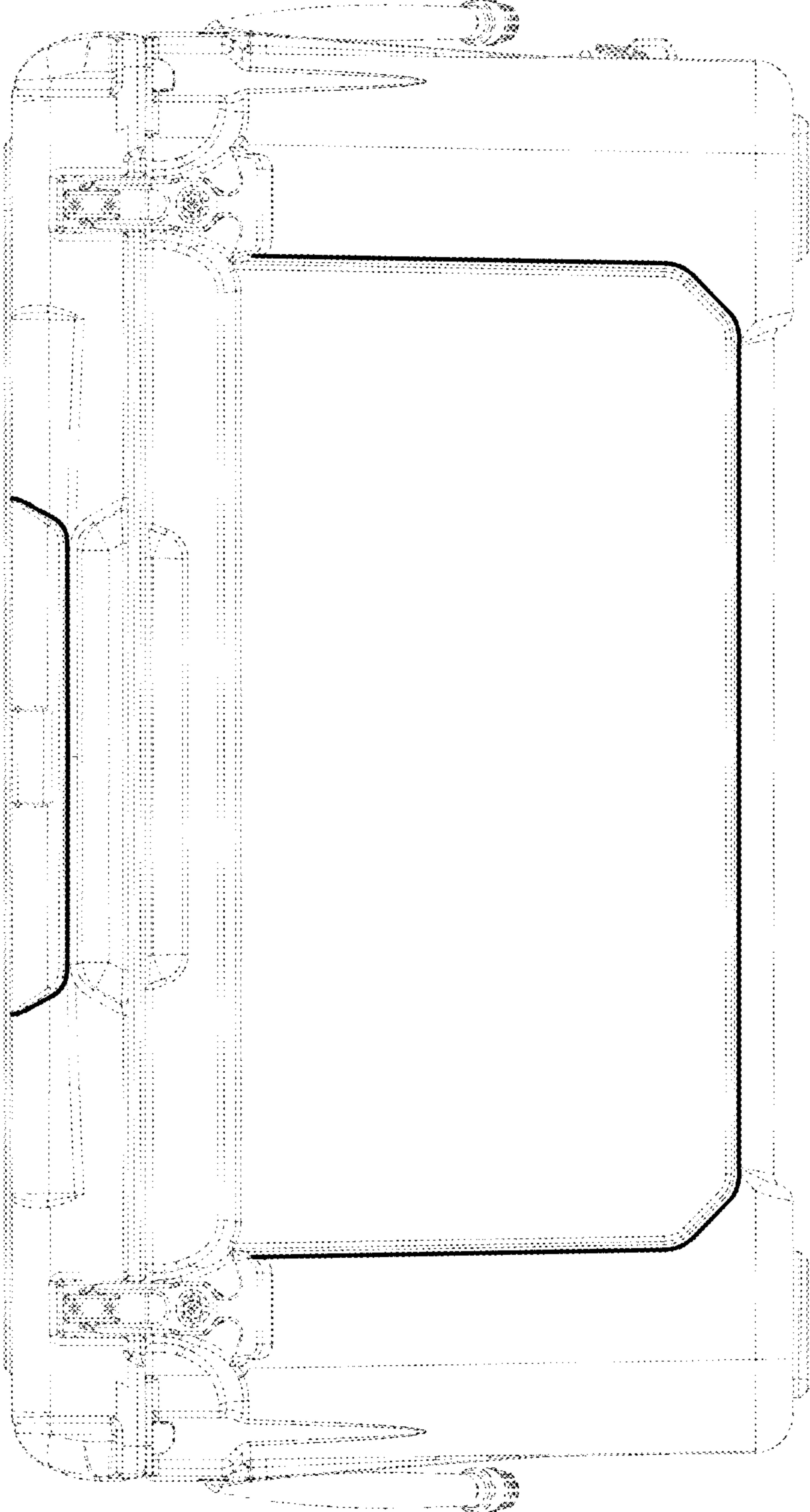

Figure 2

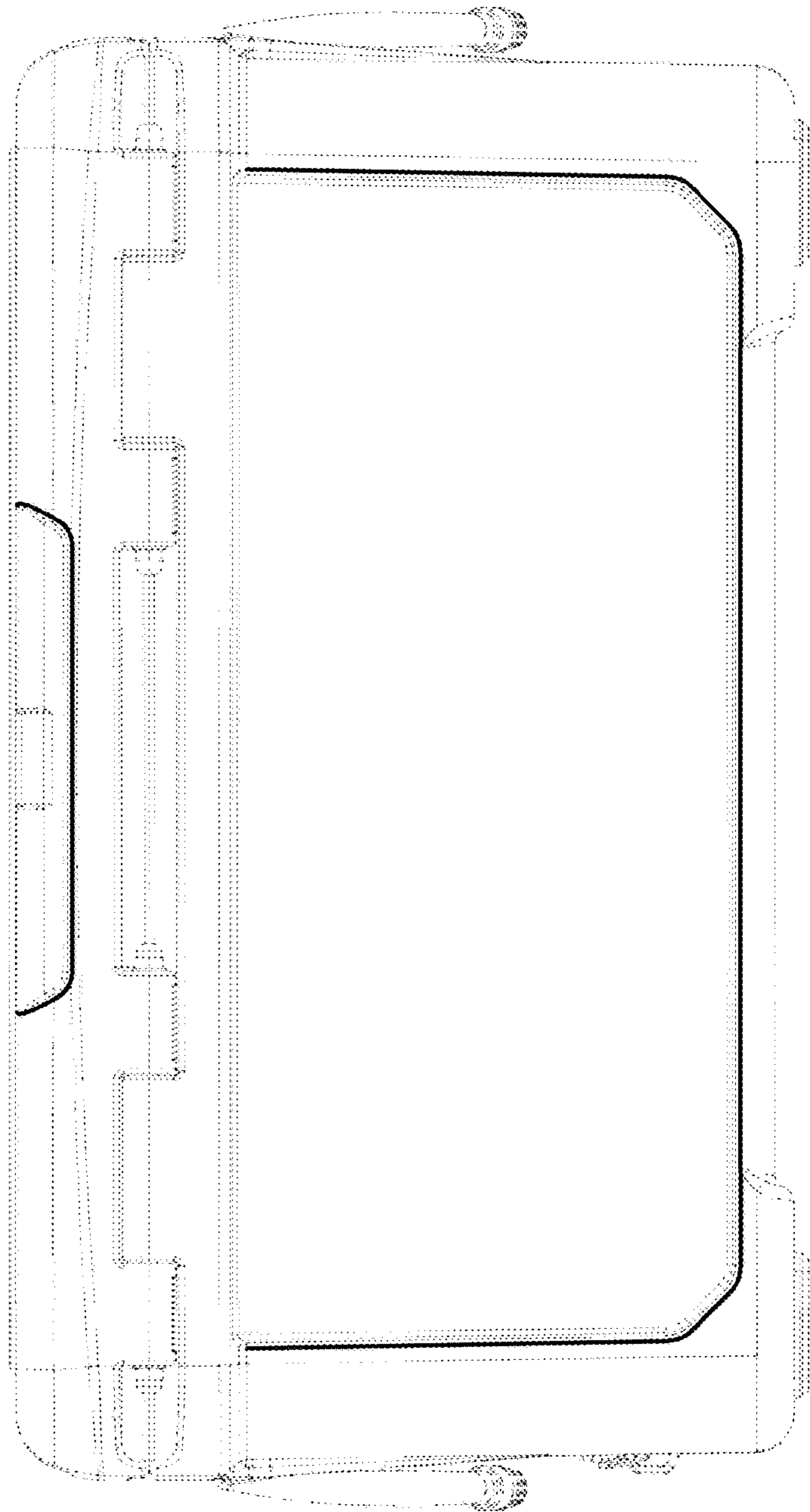

Figure 3

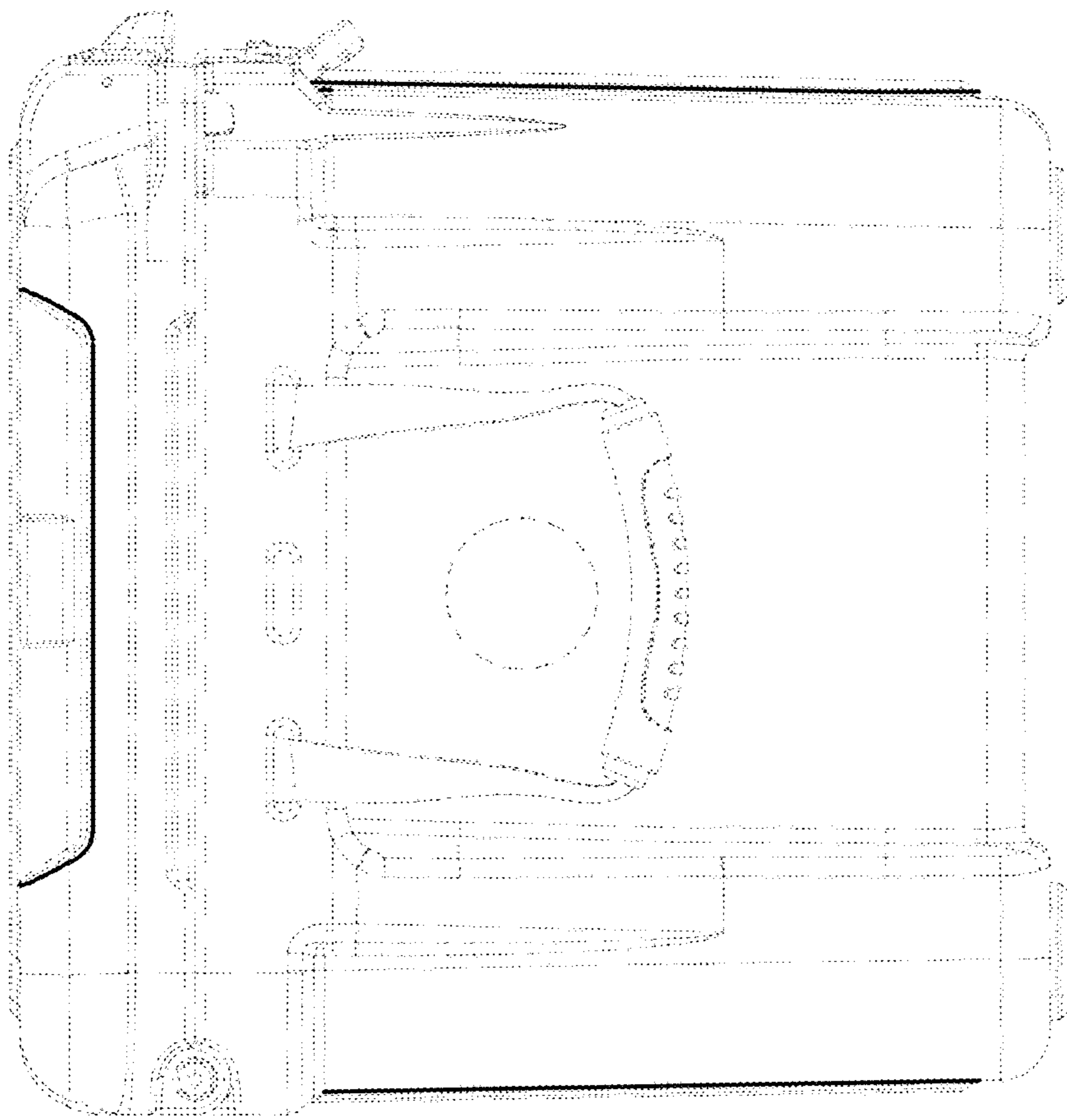

Figure 4

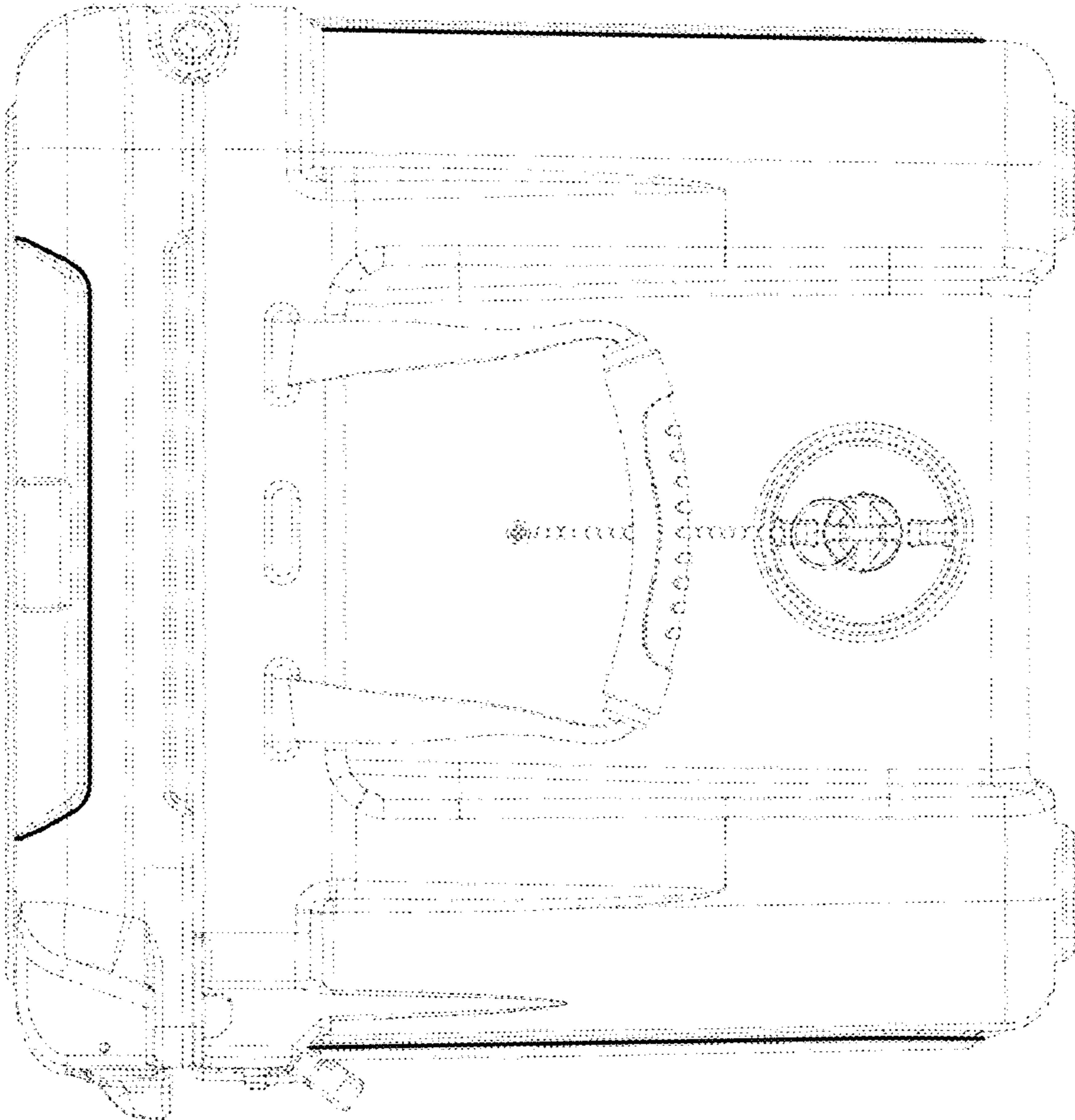

Figure 5

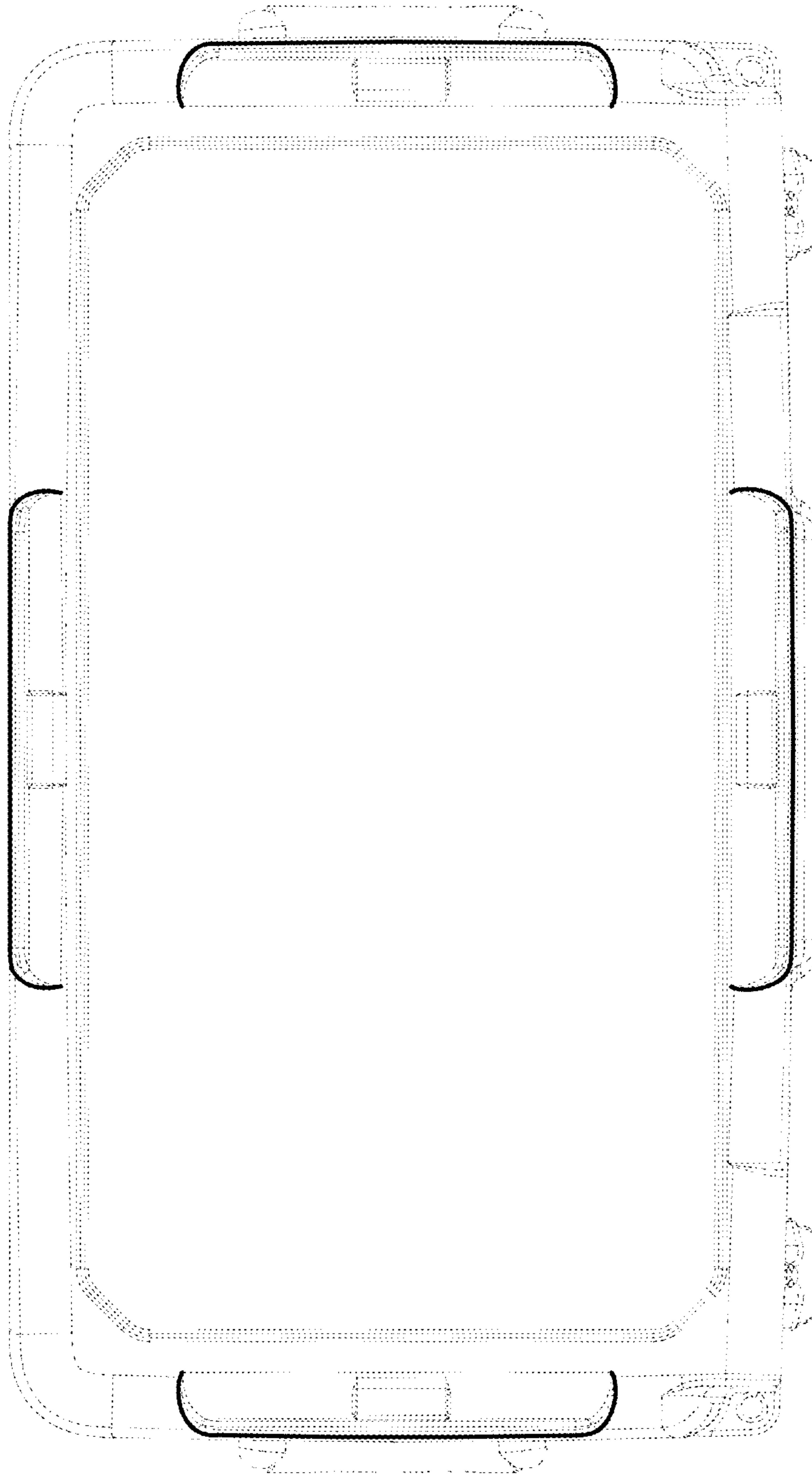

Figure 6



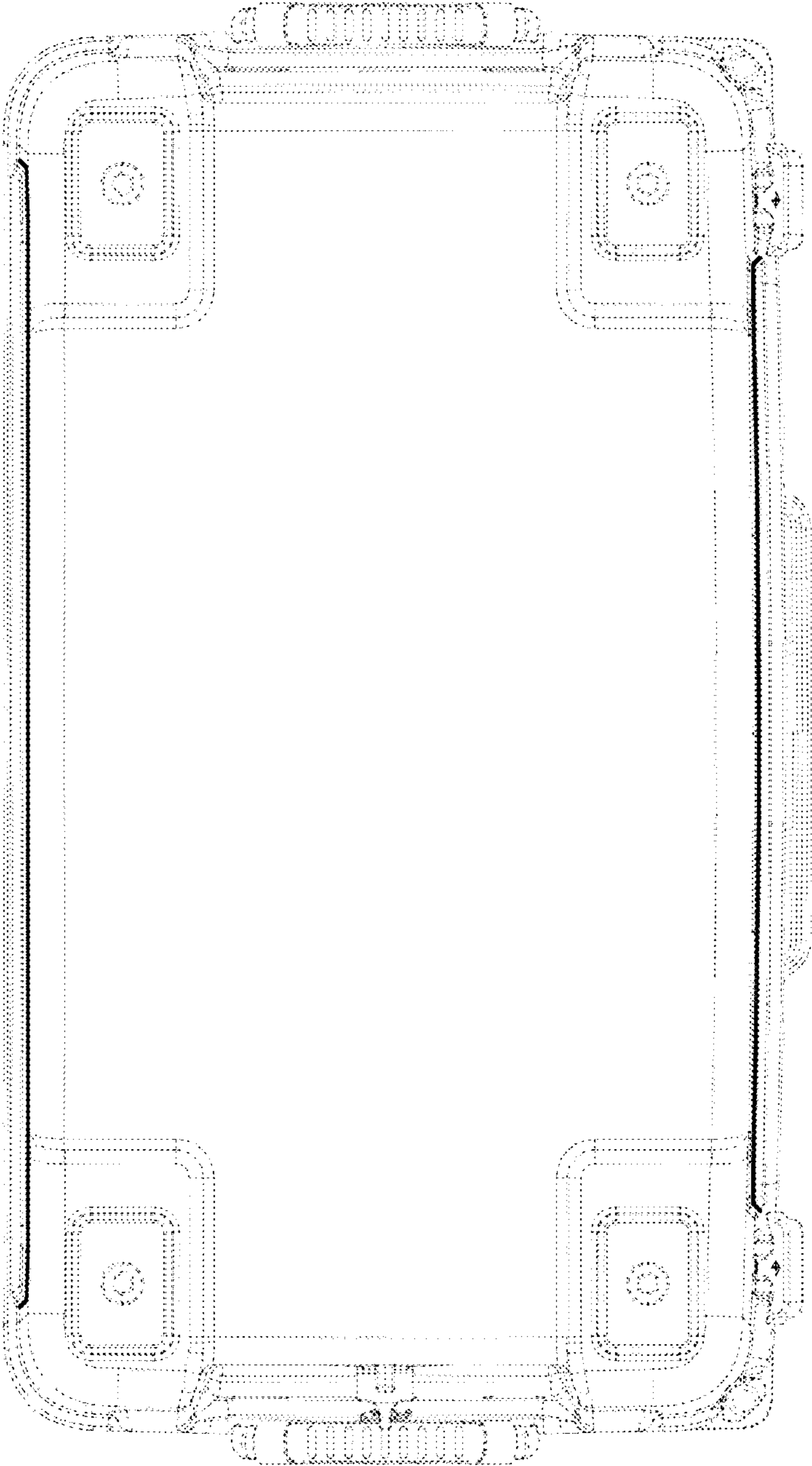

Figure 7

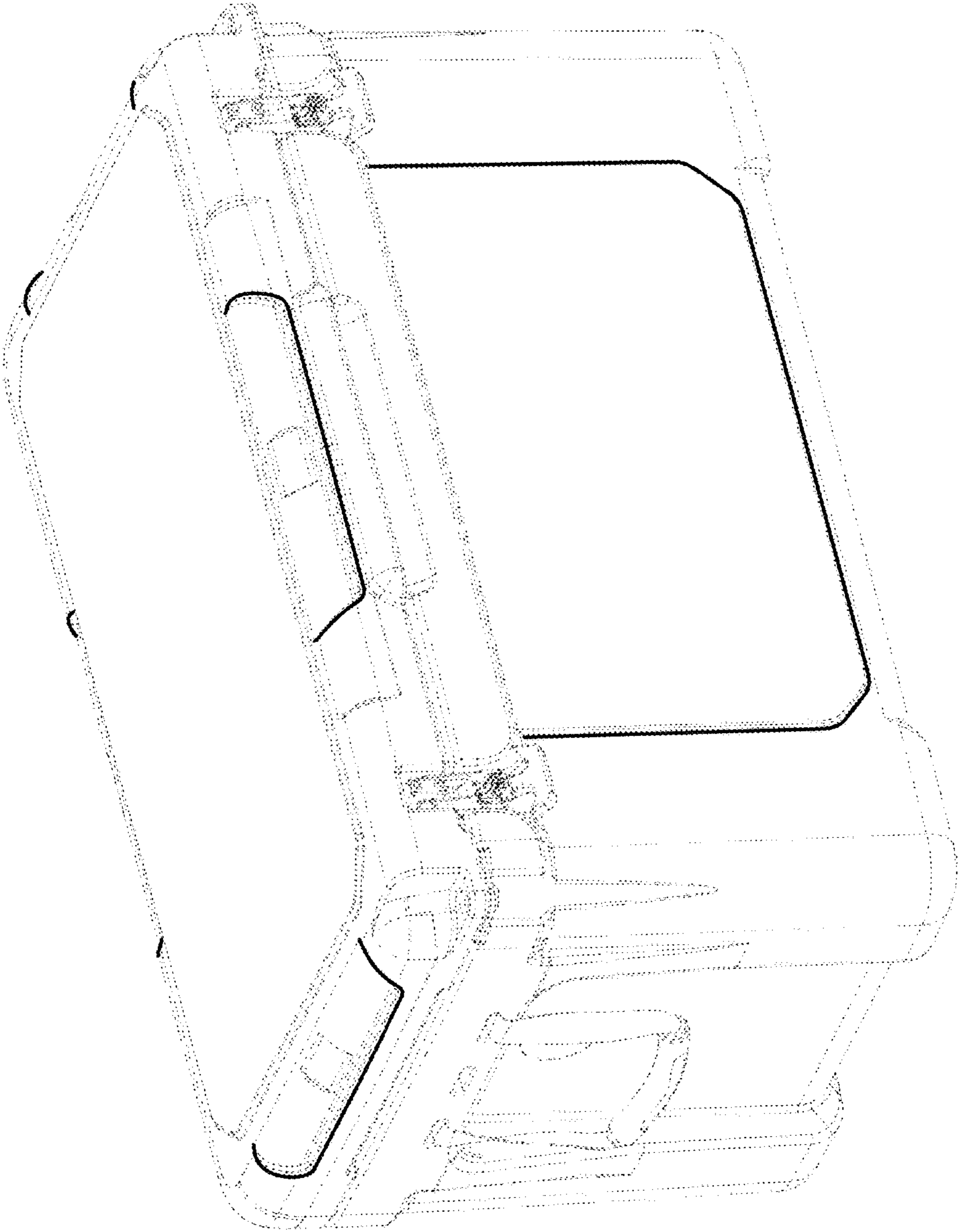

Figure 8

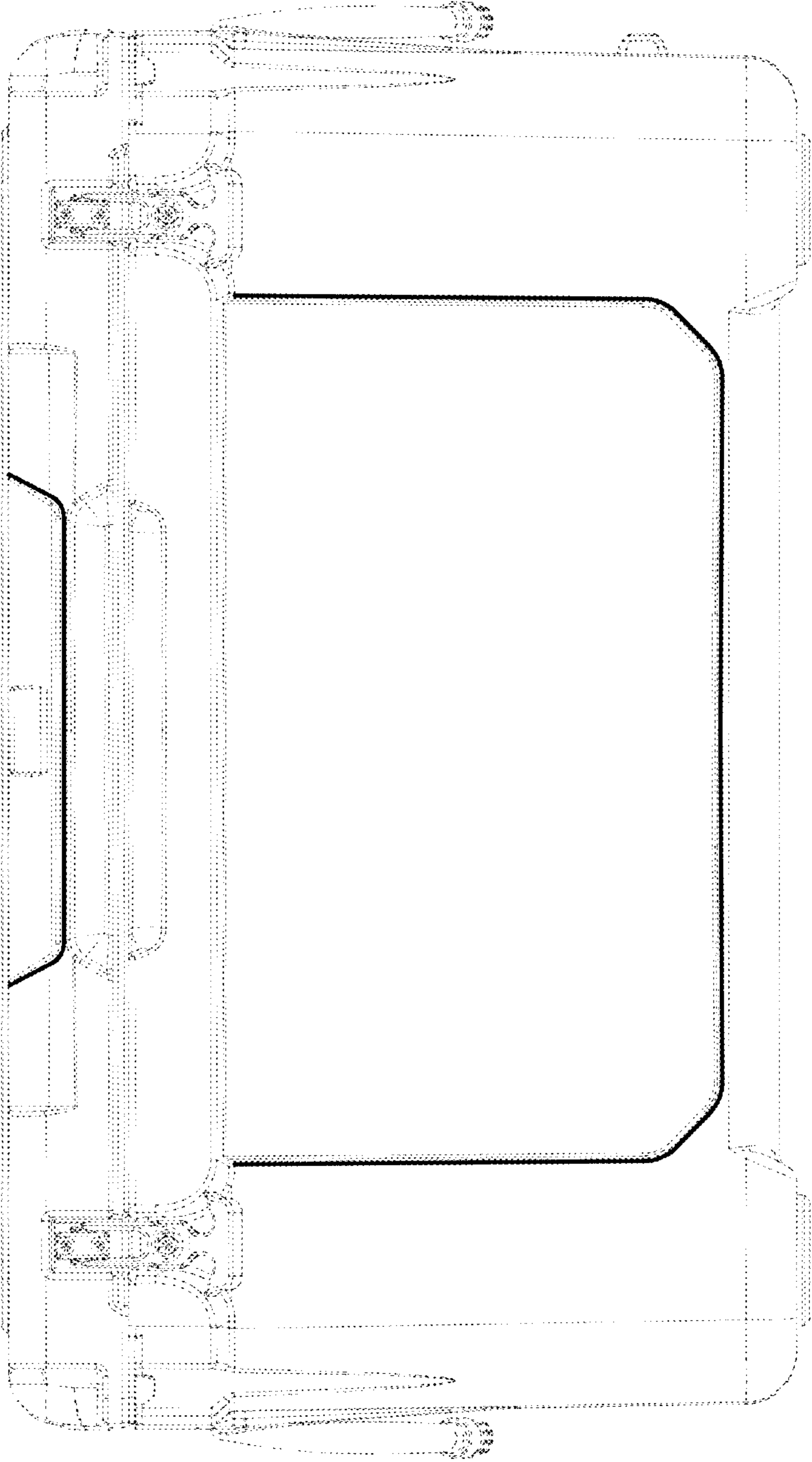

Figure 9

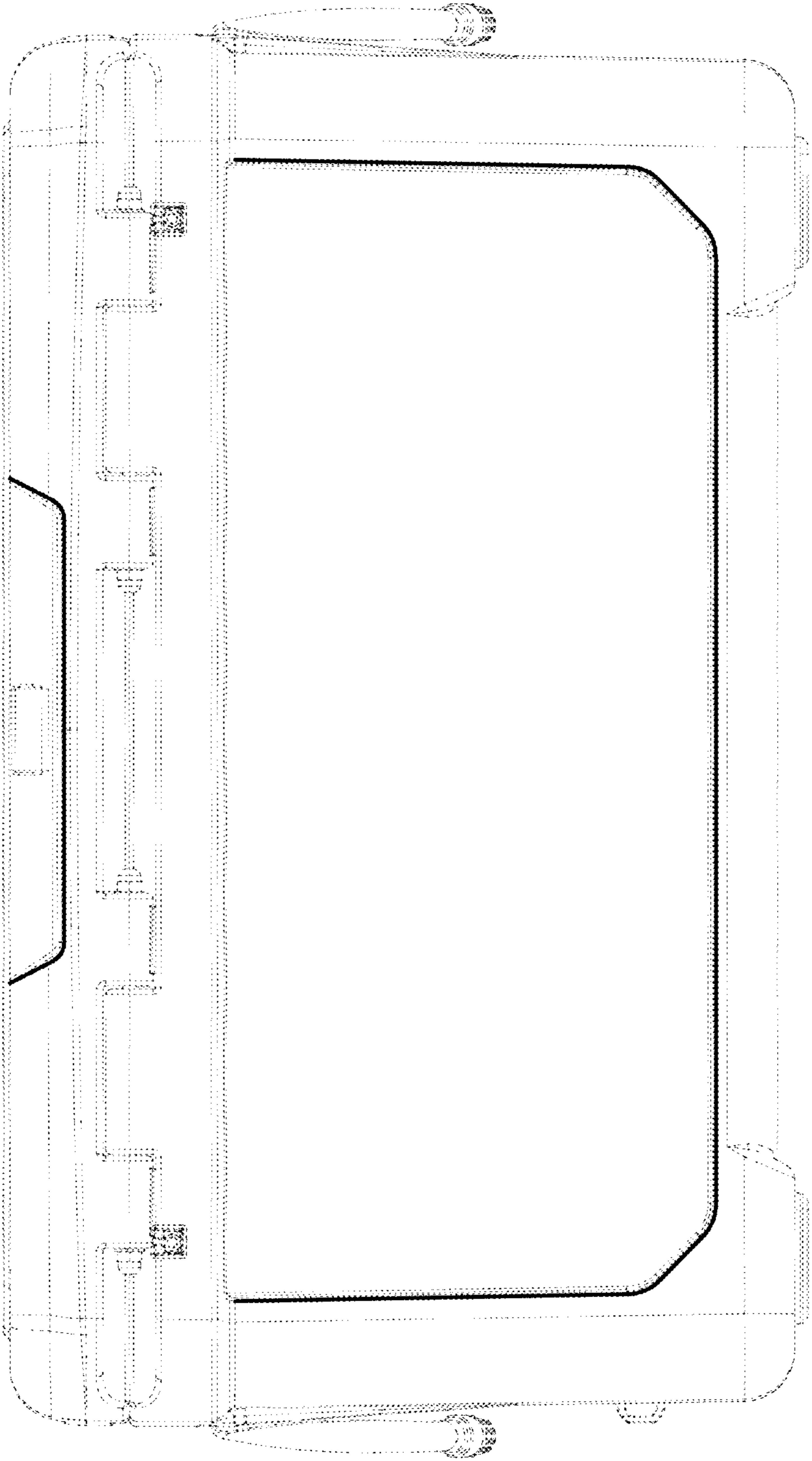

Figure 10

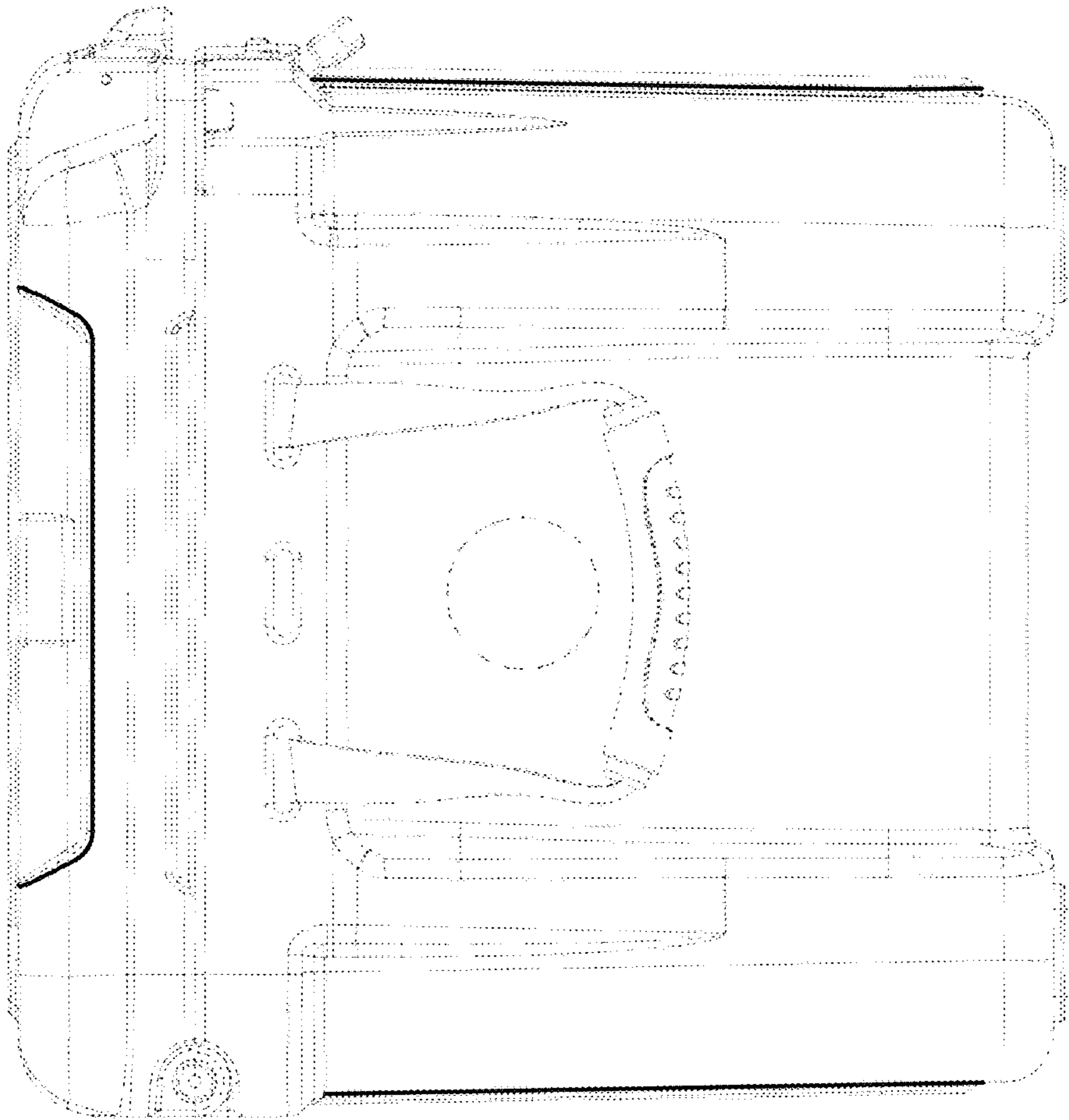

Figure 11

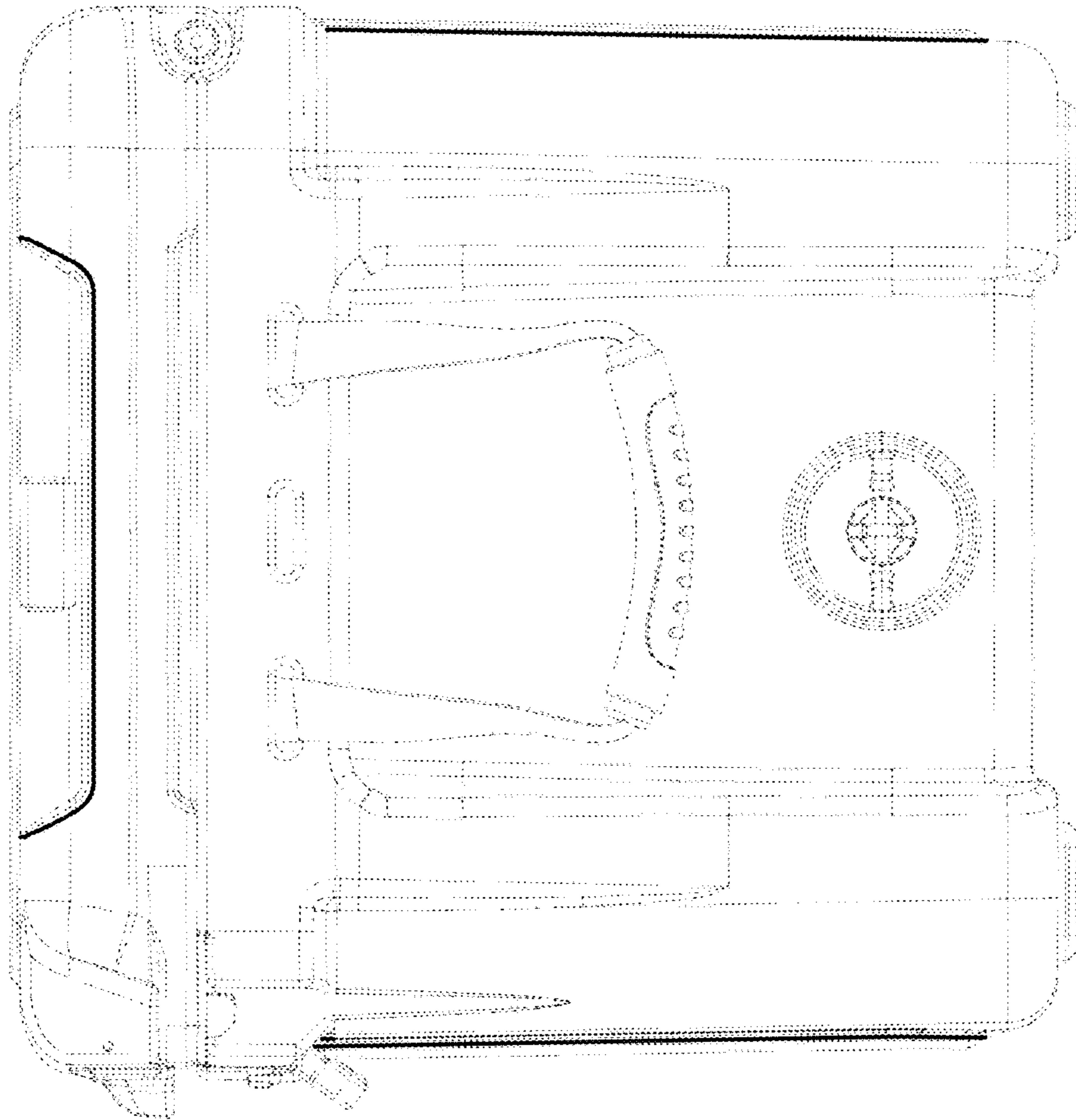

Figure 12

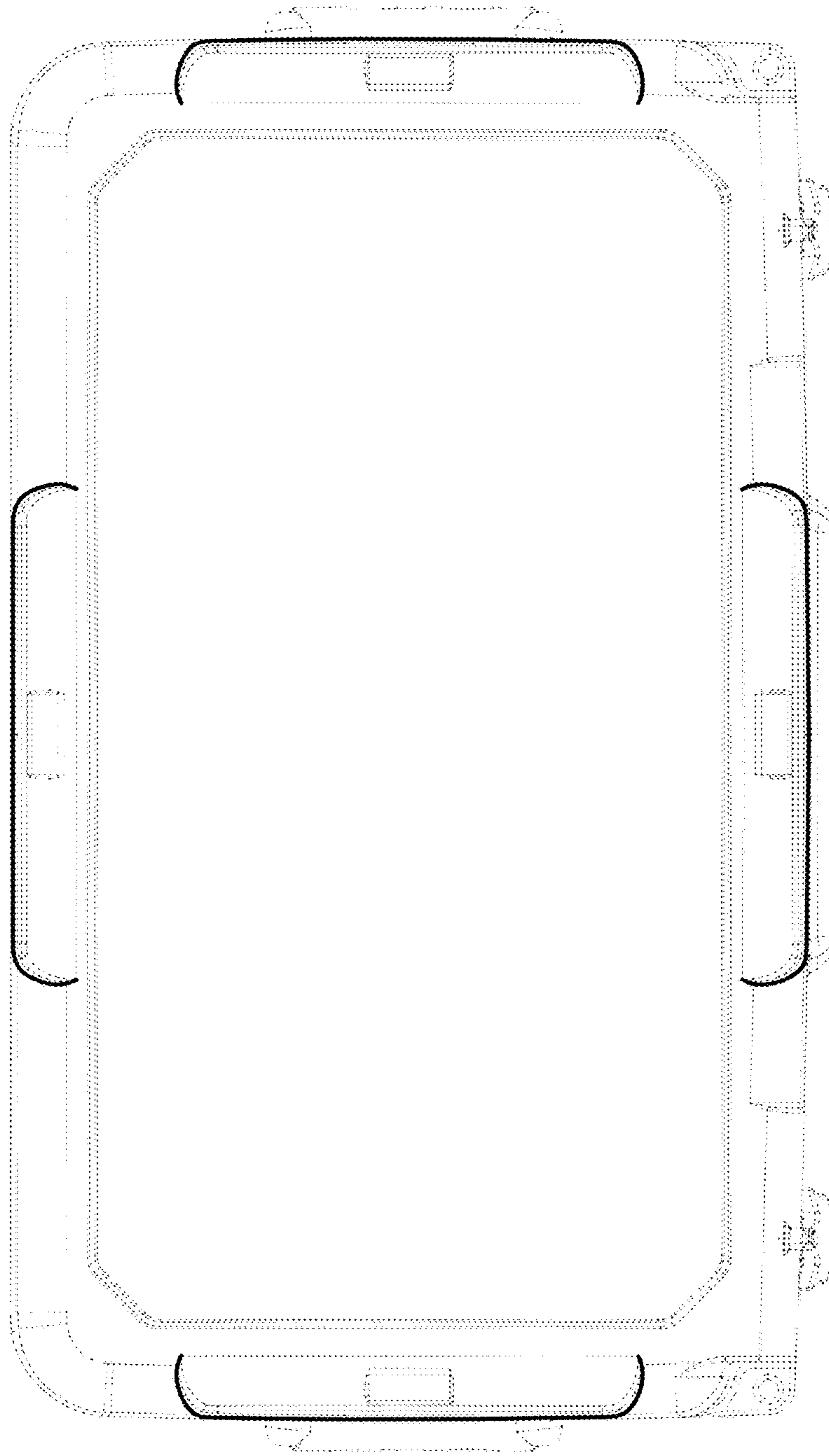

Figure 13

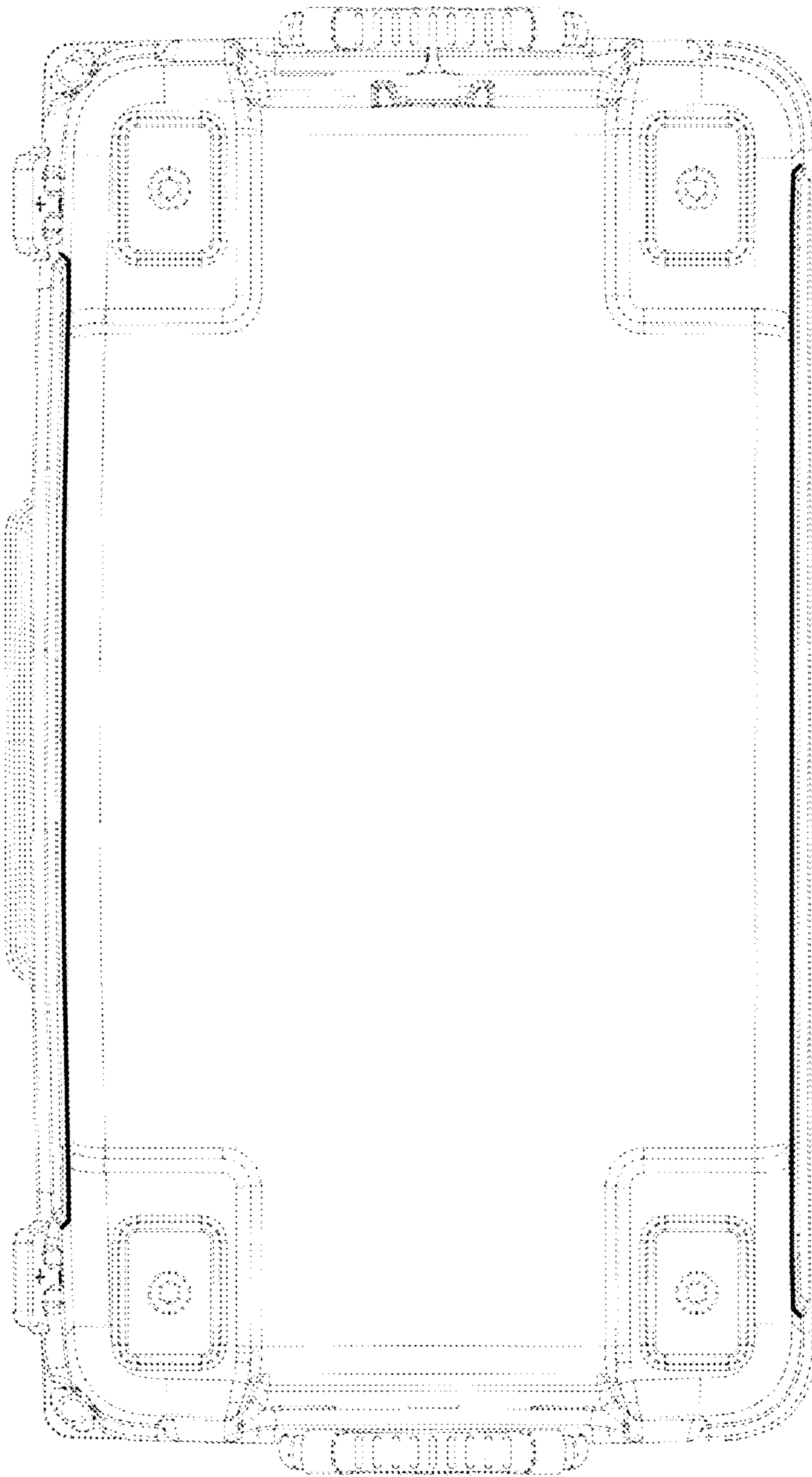

Figure 14



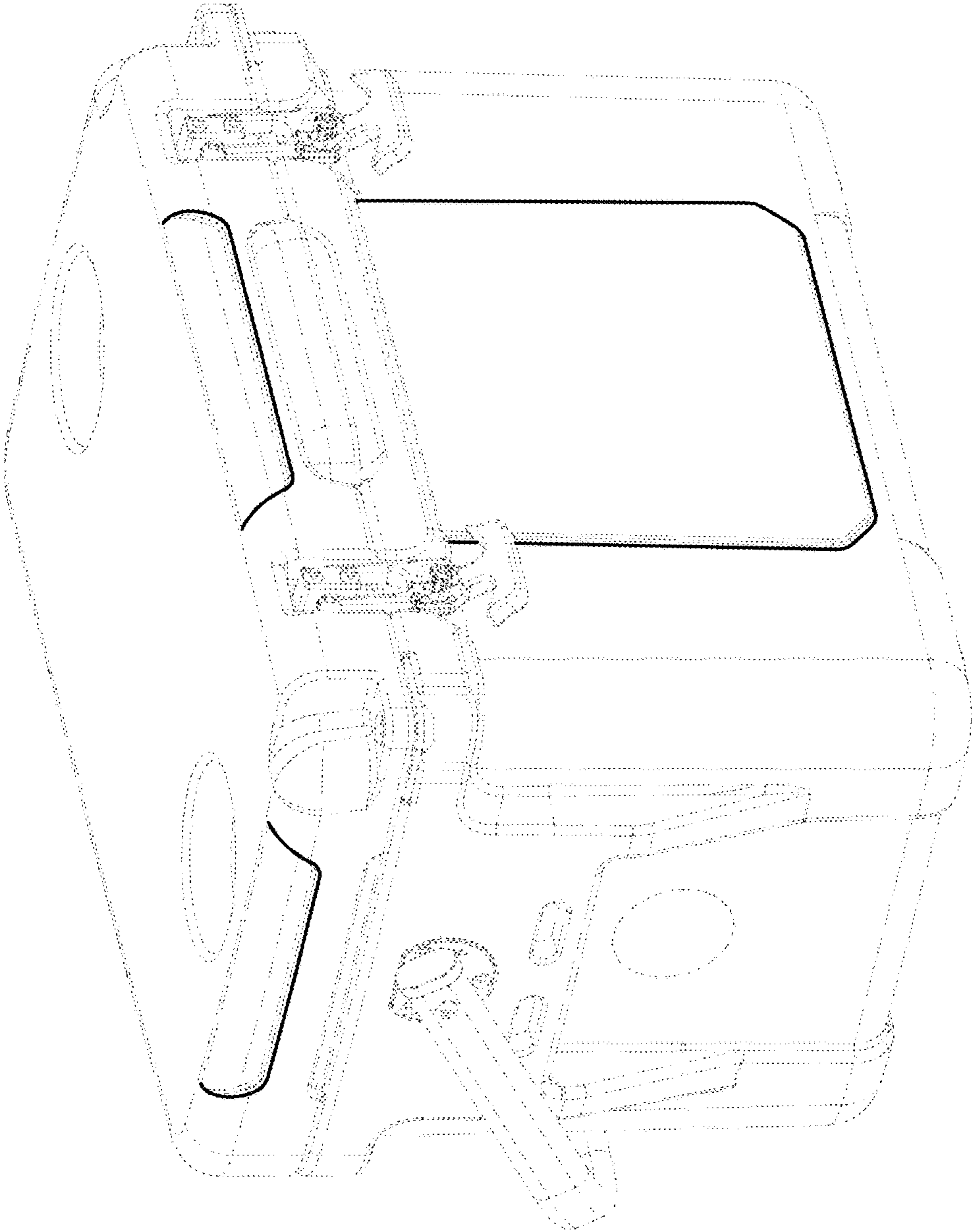

Figure 15

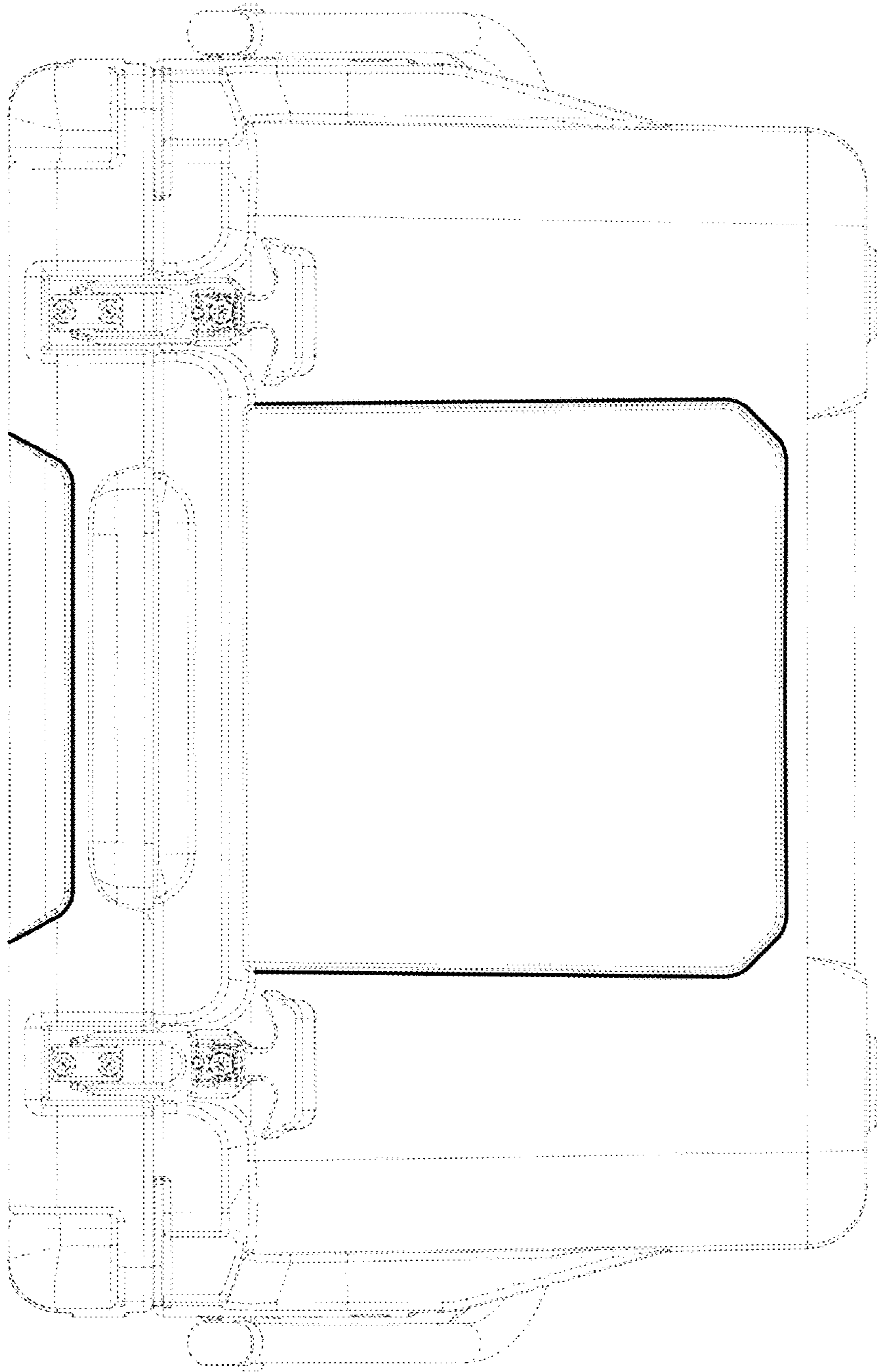

Figure 16

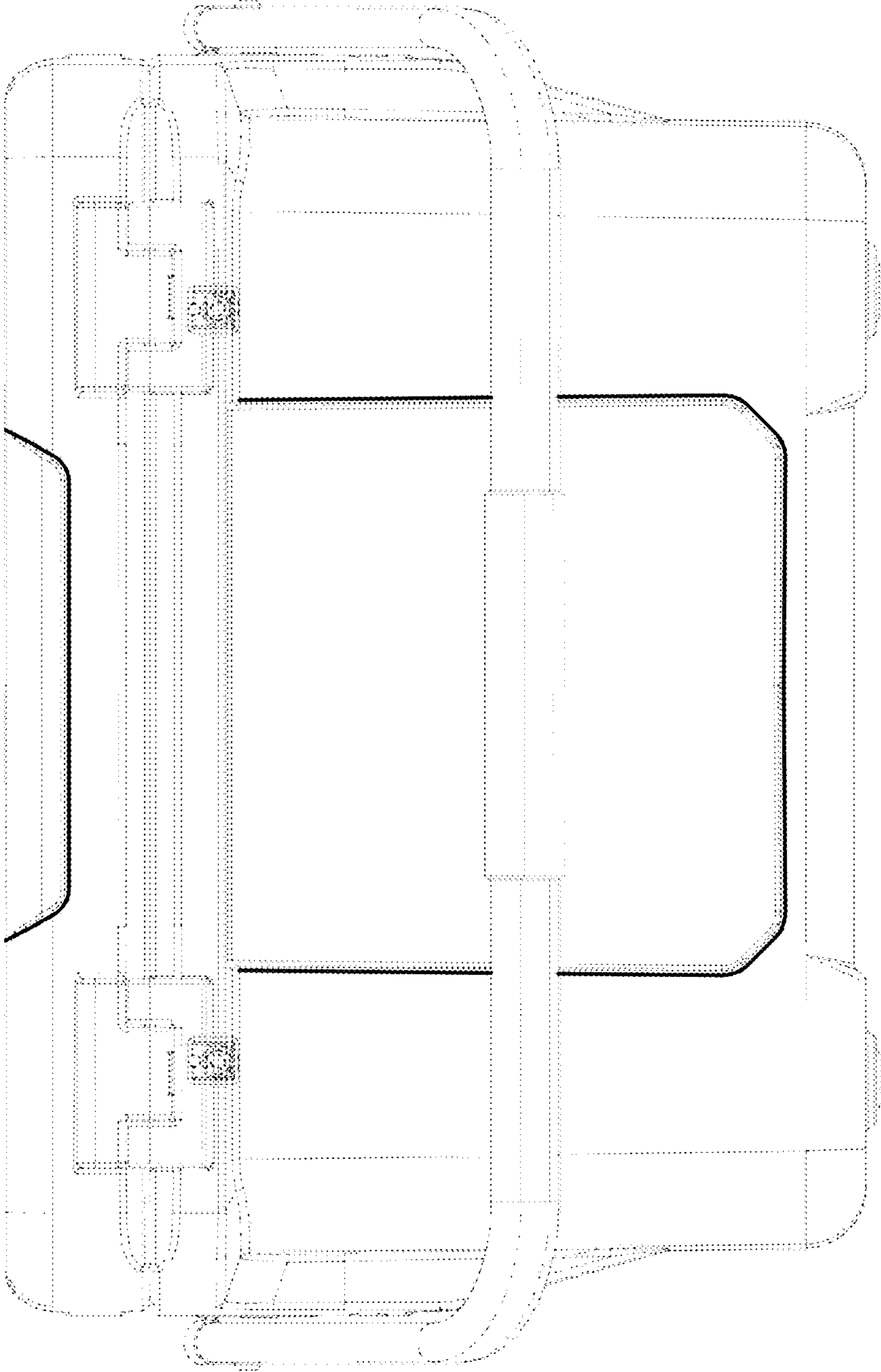

Figure 17

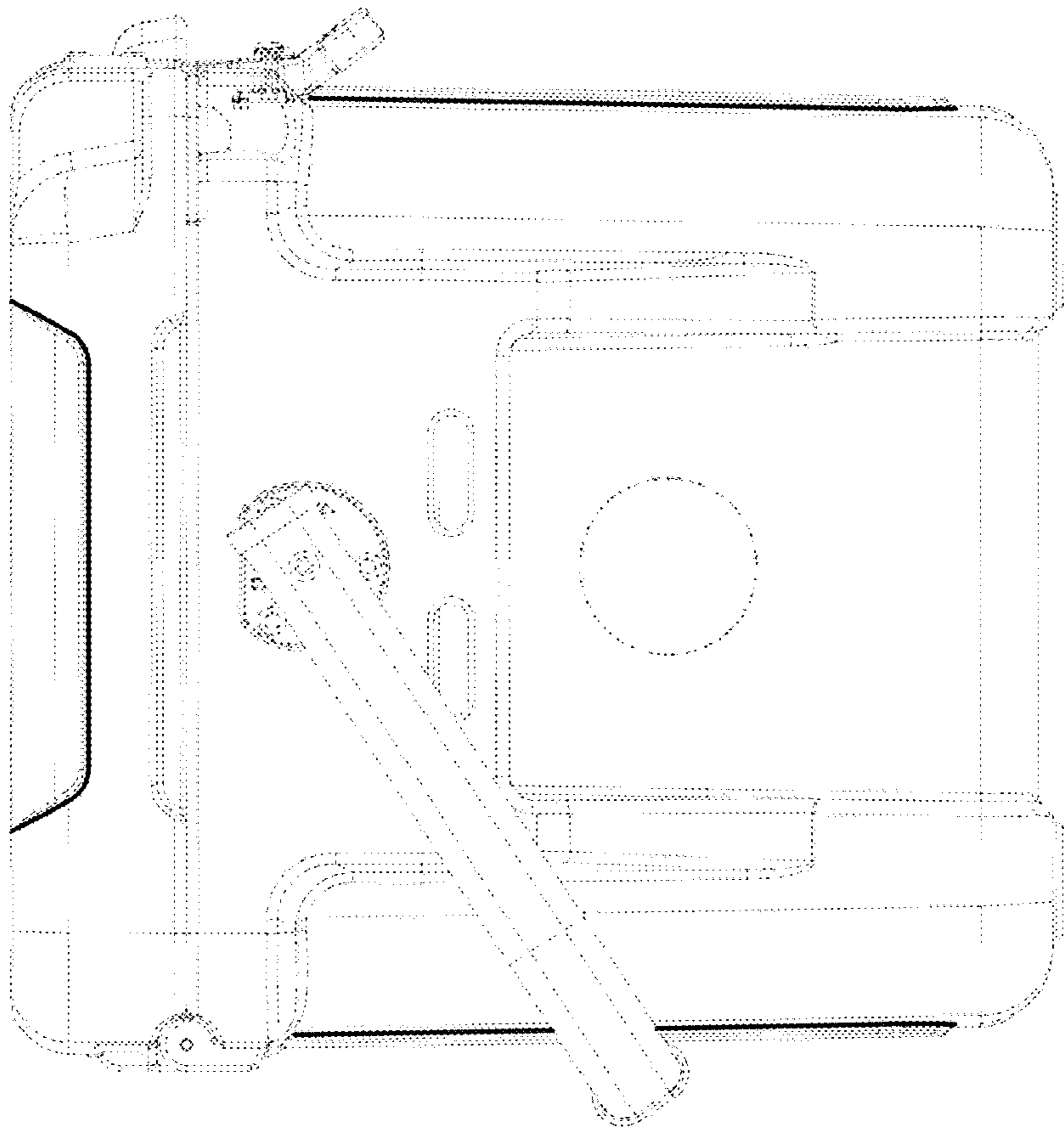

Figure 18

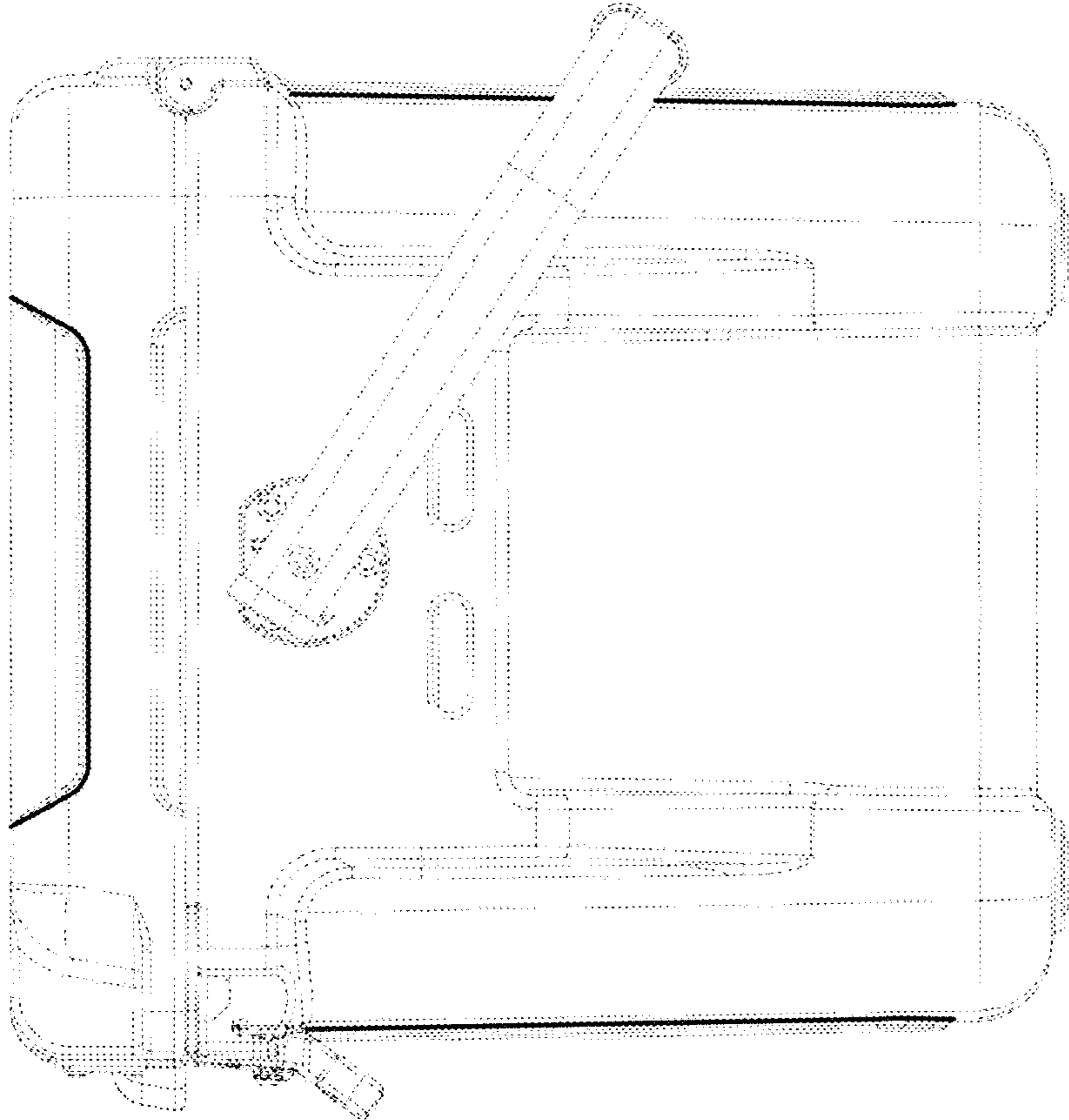

Figure 19

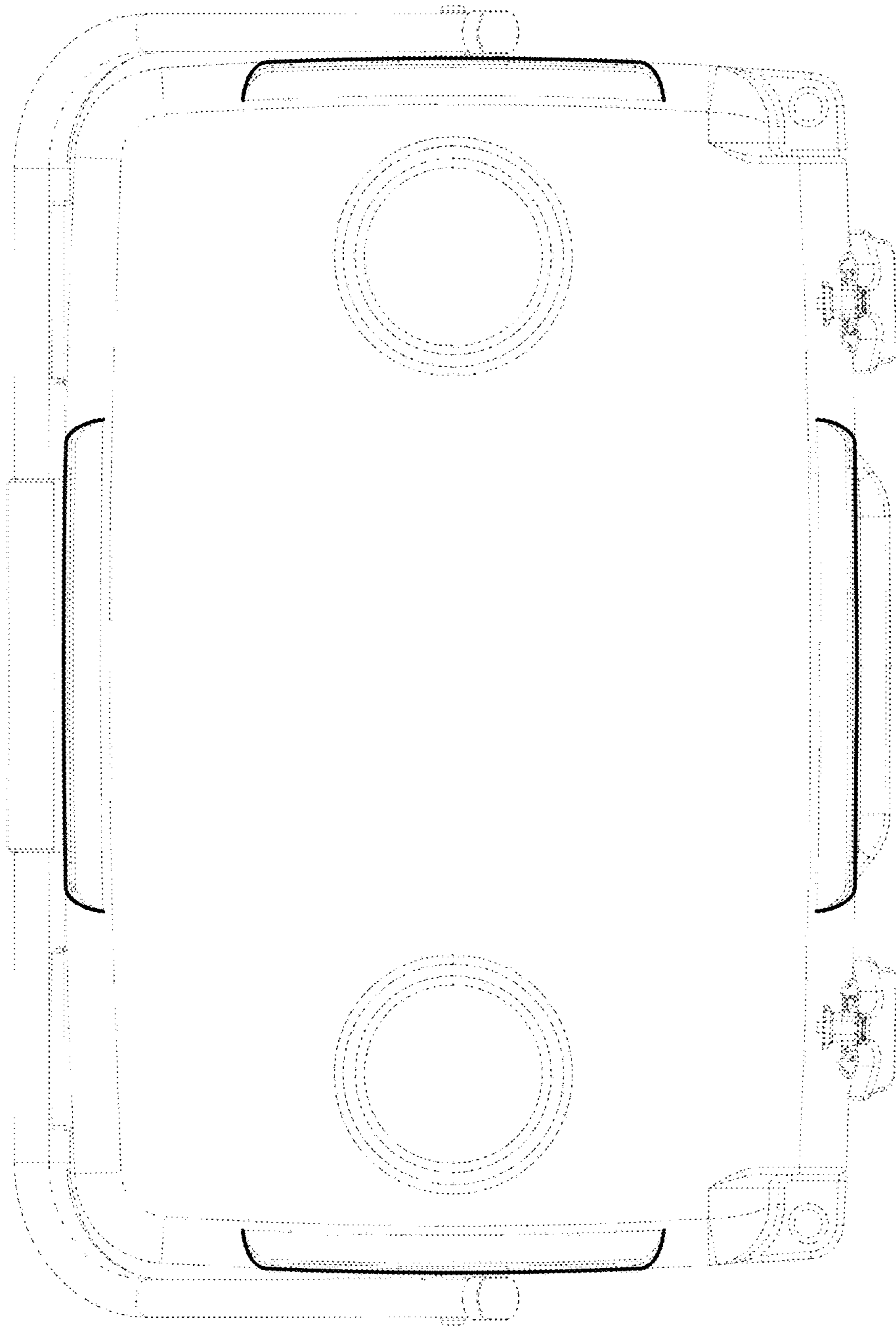

Figure 20

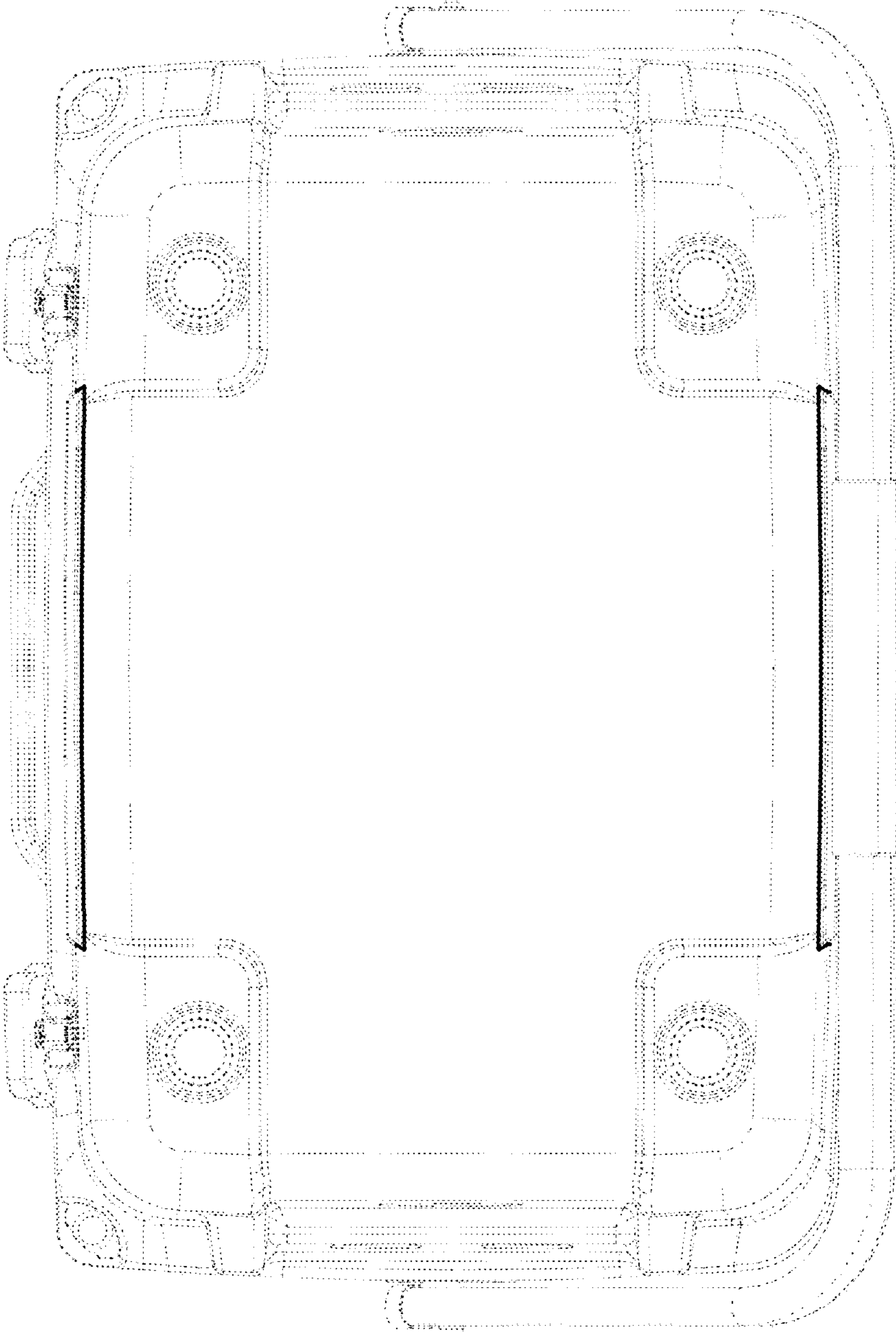

Figure 21