



US00D807093S

(12) **United States Design Patent**
Martell et al.

(10) **Patent No.:** **US D807,093 S**
(45) **Date of Patent:** **** Jan. 9, 2018**

- (54) **PORTION OF A FURNISHING**
- (71) Applicant: **Target Brands, Inc.**, Minneapolis, MN (US)
- (72) Inventors: **Timothy J. Martell**, Brooklyn Park, MN (US); **Chad M. Bogdan**, St. Paul, MN (US)
- (73) Assignee: **Target Brands, Inc.**, Minneapolis, MN (US)

(**) Term: **15 Years**

(21) Appl. No.: **29/584,120**

(22) Filed: **Nov. 11, 2016**

(51) **LOC (11) Cl.** **06-01**

(52) **U.S. Cl.**
USPC **D6/717; D6/379; D6/716.3**

(58) **Field of Classification Search**
USPC D6/334-336, 364, 369, 370, 374, 375, D6/379, 380, 716, 716.3, 717
CPC .. A47C 3/04; A47C 4/02; A47C 4/027; A47C 3/12; A47C 5/12; A47C 7/16; A47C 7/54
See application file for complete search history.

(56) **References Cited**

U.S. PATENT DOCUMENTS

D137,587 S *	4/1944	Harasty	D6/370
2,364,452 A *	12/1944	Kramer	A47C 4/02 297/343

D188,046 S *	5/1960	Galloway	D6/379
D222,453 S *	10/1971	Ziss	D6/370
D261,958 S *	11/1981	Dowse	D6/375
D296,848 S *	7/1988	Colby	D6/379
D323,249 S *	1/1992	Schwartz	D6/370
D422,423 S *	4/2000	Lin	D6/369
D647,335 S *	10/2011	Delmestri	D6/379
D660,036 S	5/2012	Grotta et al.	
D660,038 S	5/2012	Hoyord et al.	
D746,608 S *	1/2016	Kirar	D6/364
D764,202 S *	8/2016	Kirar	D6/364

* cited by examiner

Primary Examiner — Mimosa De

(74) *Attorney, Agent, or Firm* — Leanne Taveggia Farrell; Westman, Champlin & Koehler, P.A.

(57) **CLAIM**

The ornamental design for a portion of a furnishing, as shown and described.

DESCRIPTION

FIG. 1 is a perspective view of a portion of a furnishing showing our new design;
 FIG. 2 is a front view thereof;
 FIG. 3 is a rear view thereof;
 FIG. 4 is a left side view thereof;
 FIG. 5 is a right side view thereof;
 FIG. 6 is a top view thereof; and,
 FIG. 7 is a bottom view thereof.
 The broken lines shown in the drawings form no part of the claimed design.

1 Claim, 7 Drawing Sheets

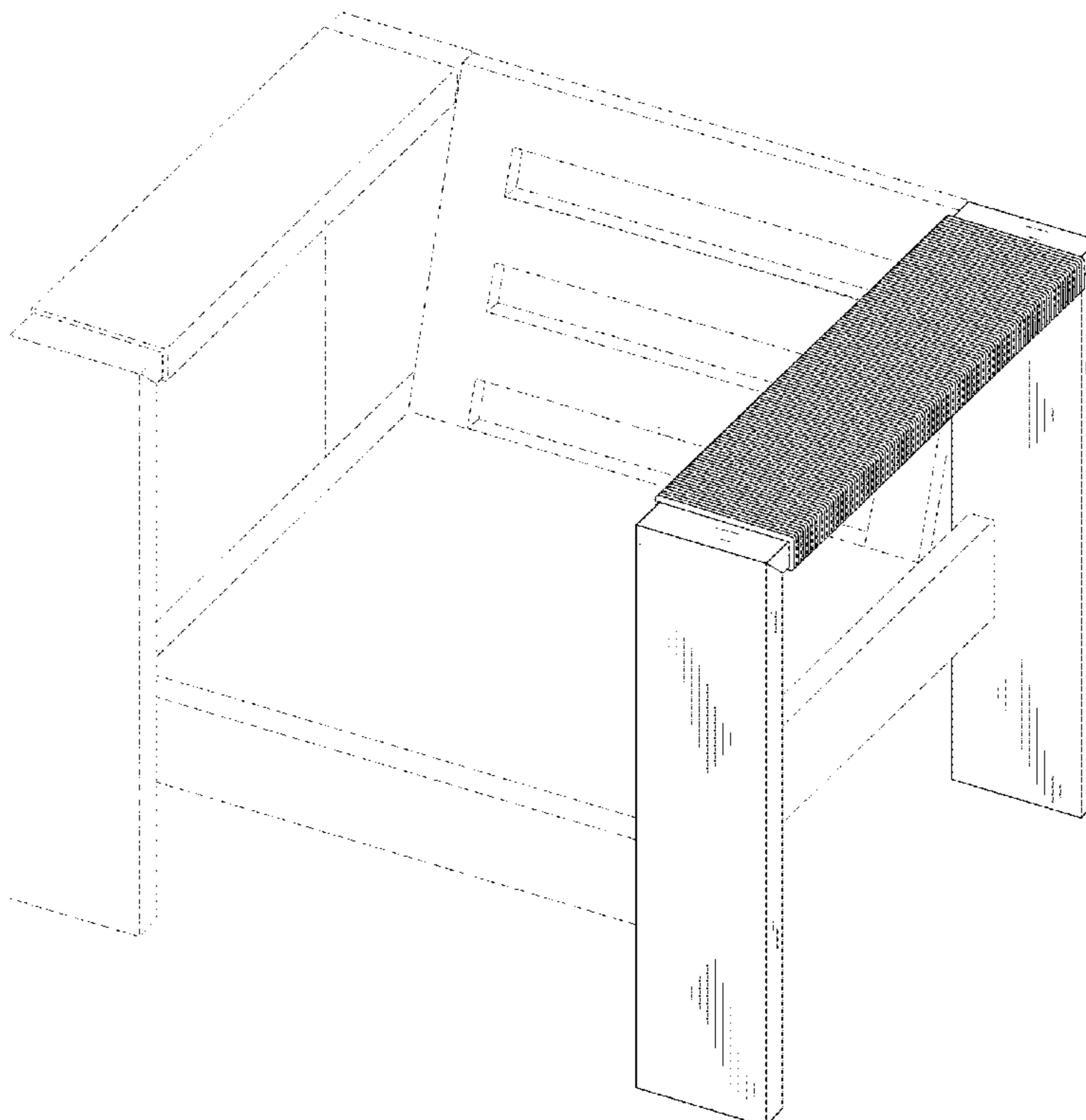

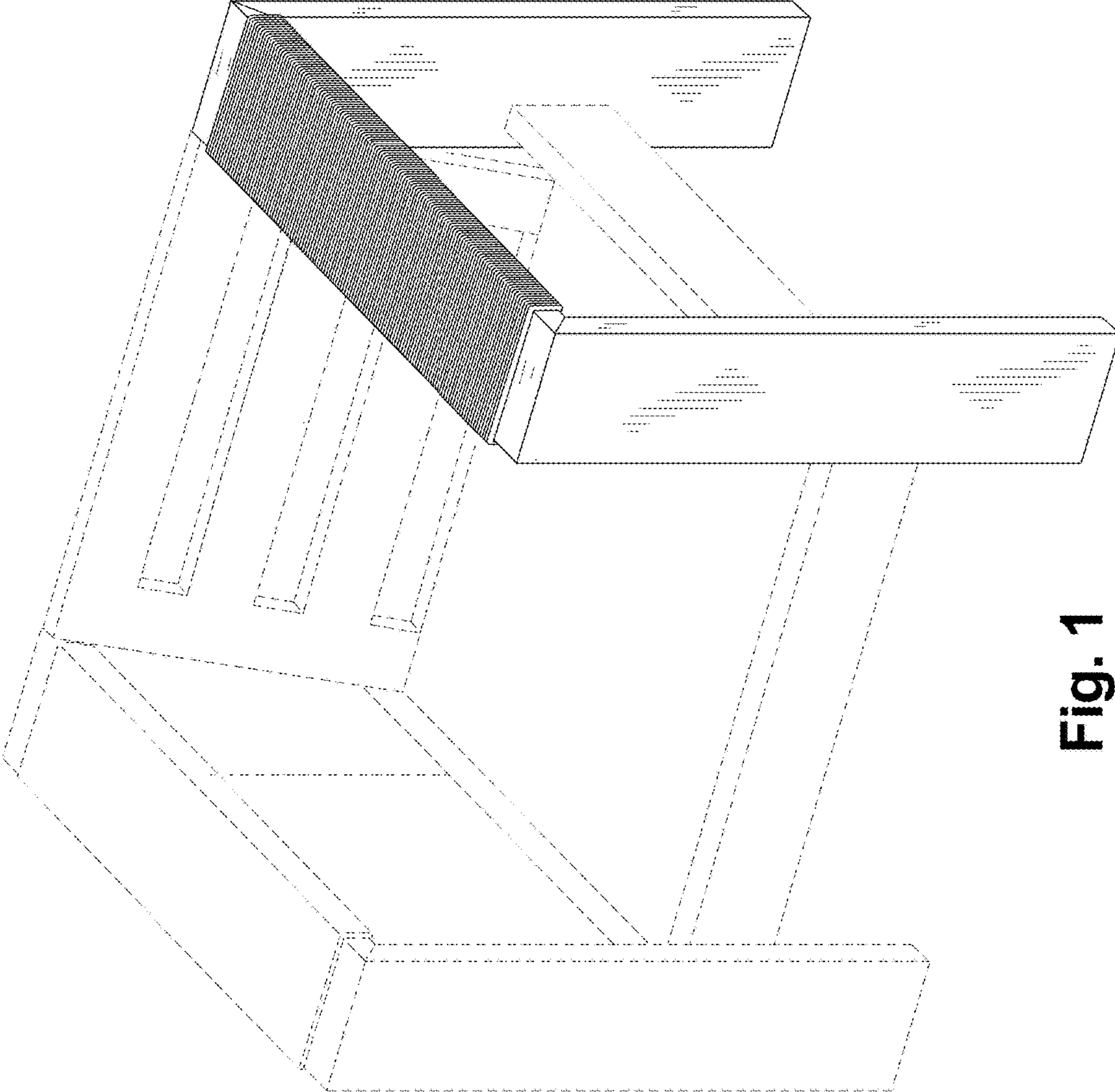

Fig. 1

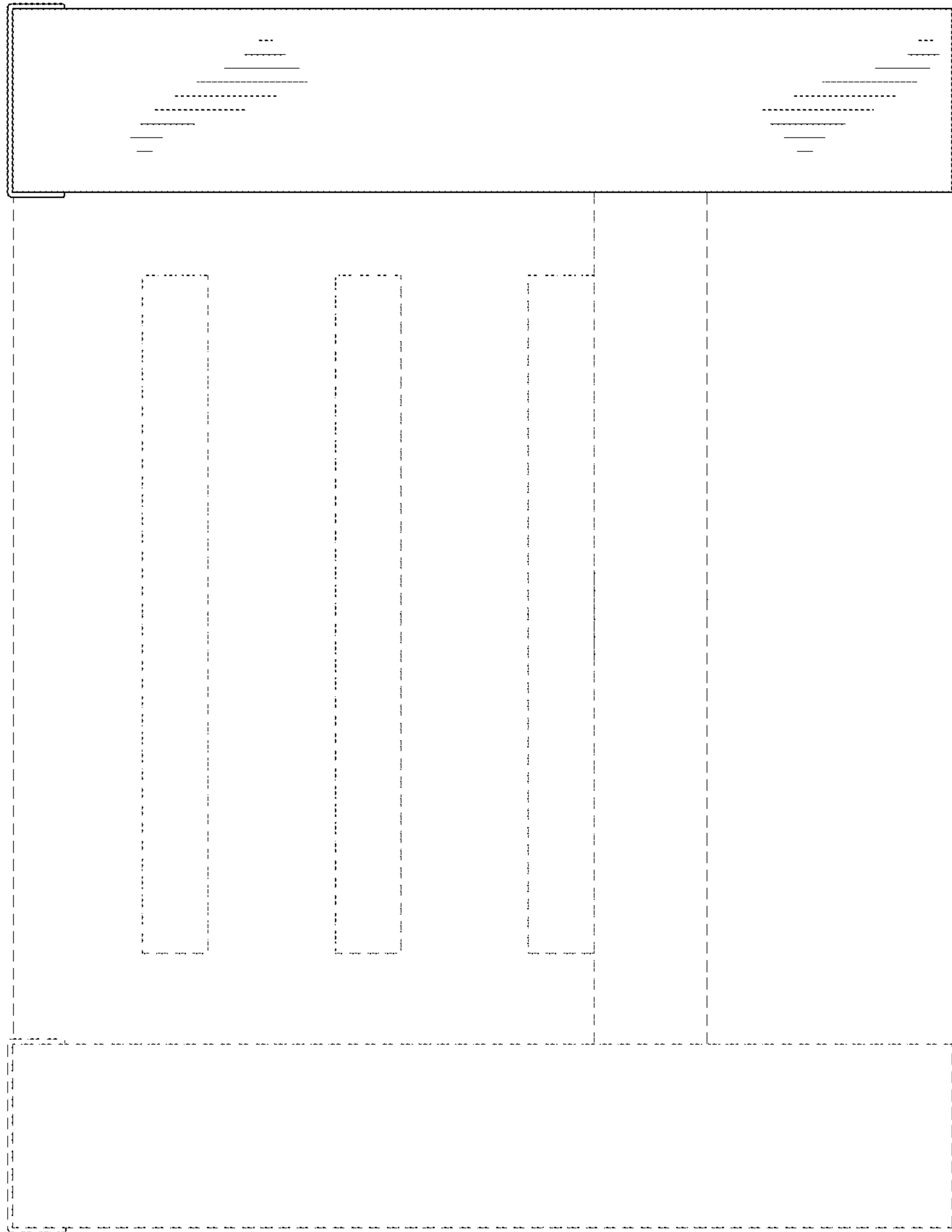

Fig. 2

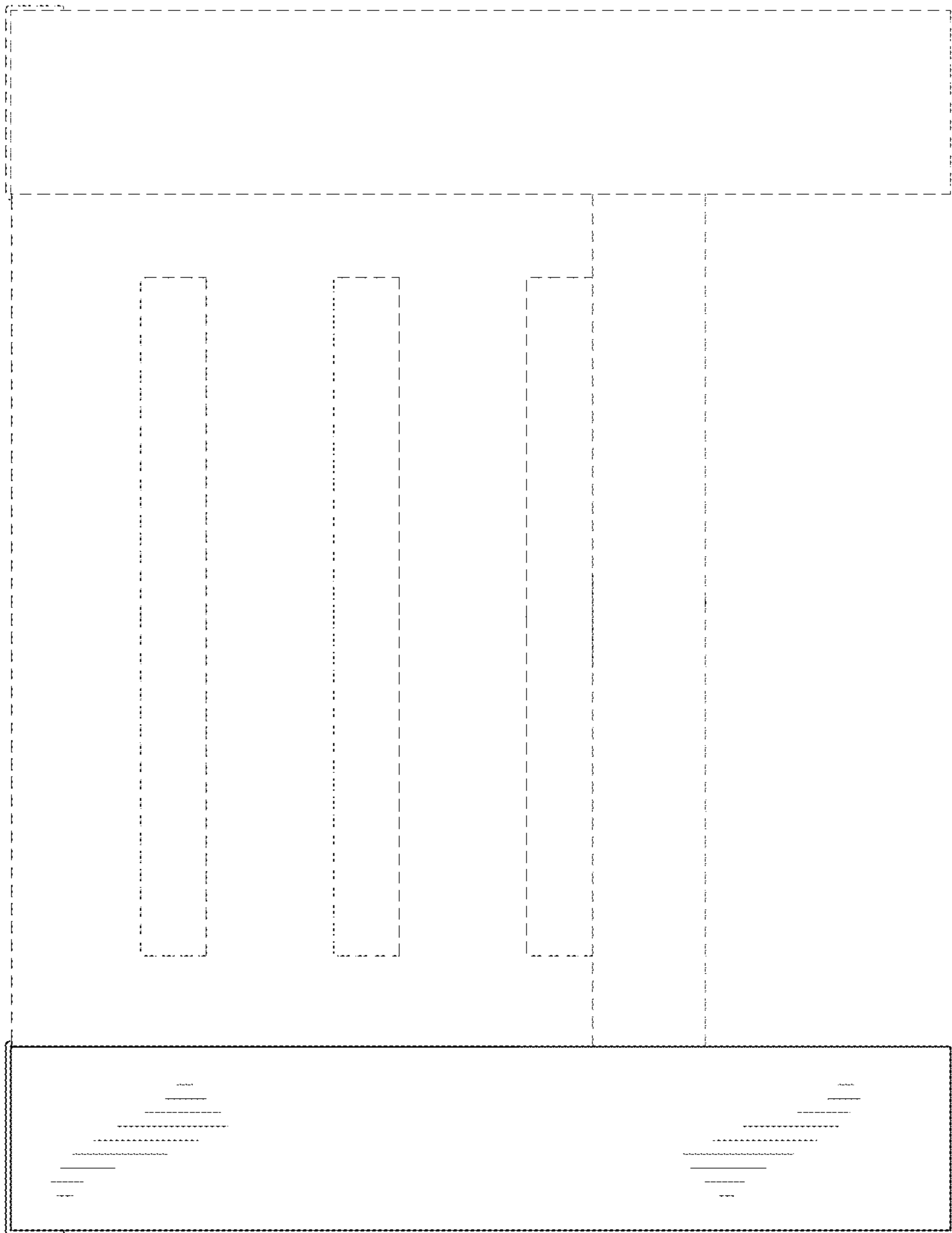

Fig. 3

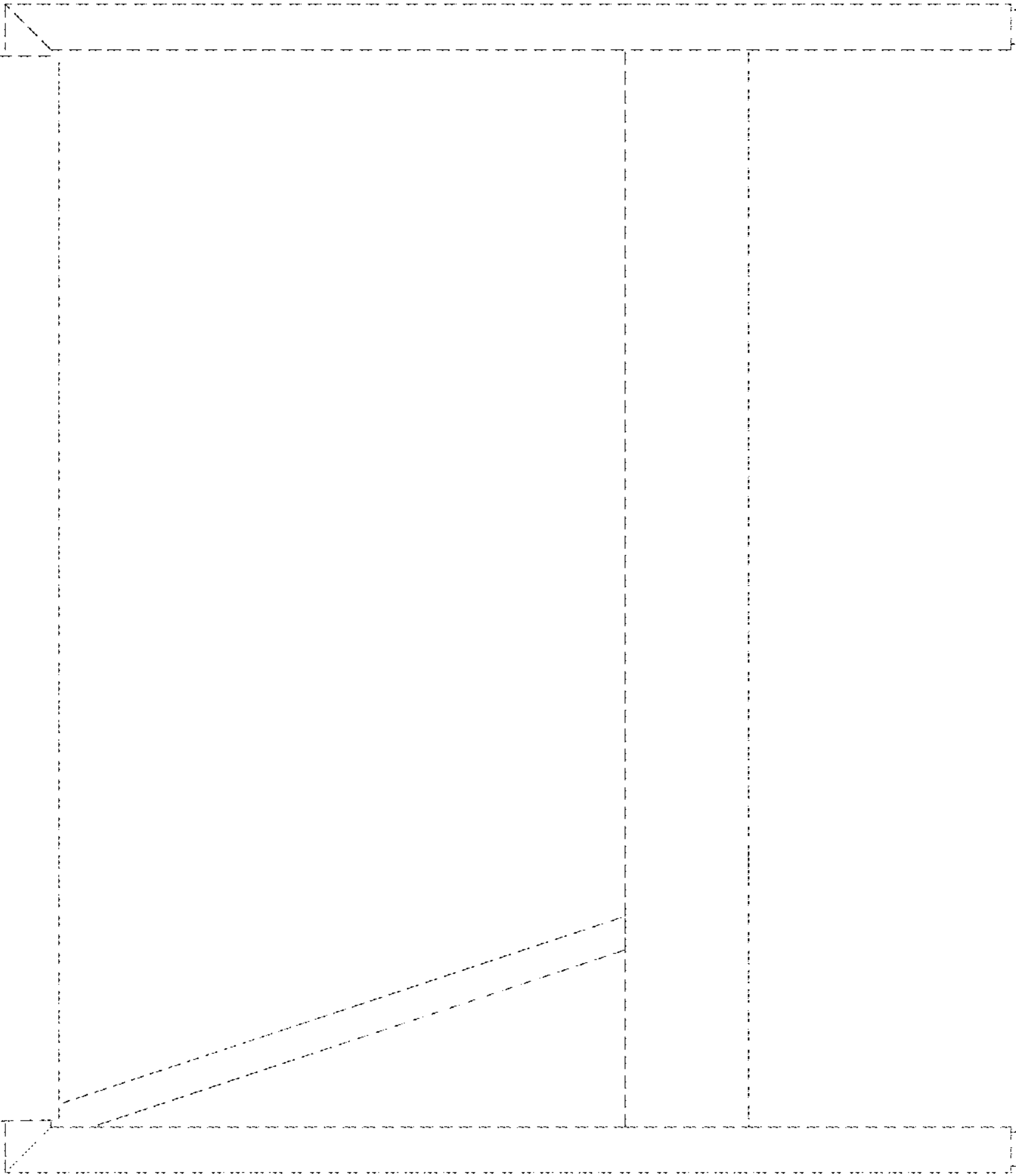

Fig. 4

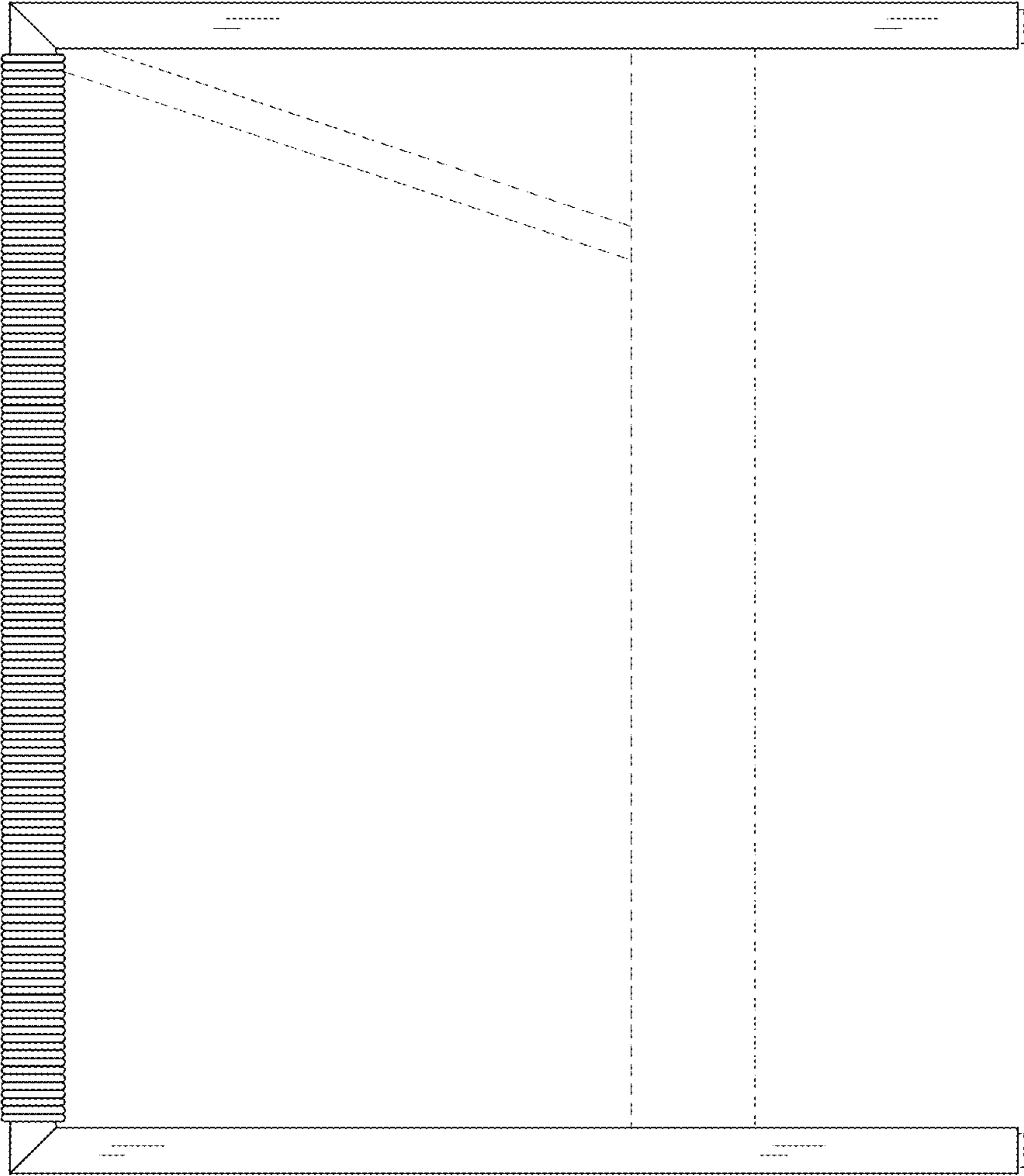

Fig. 5

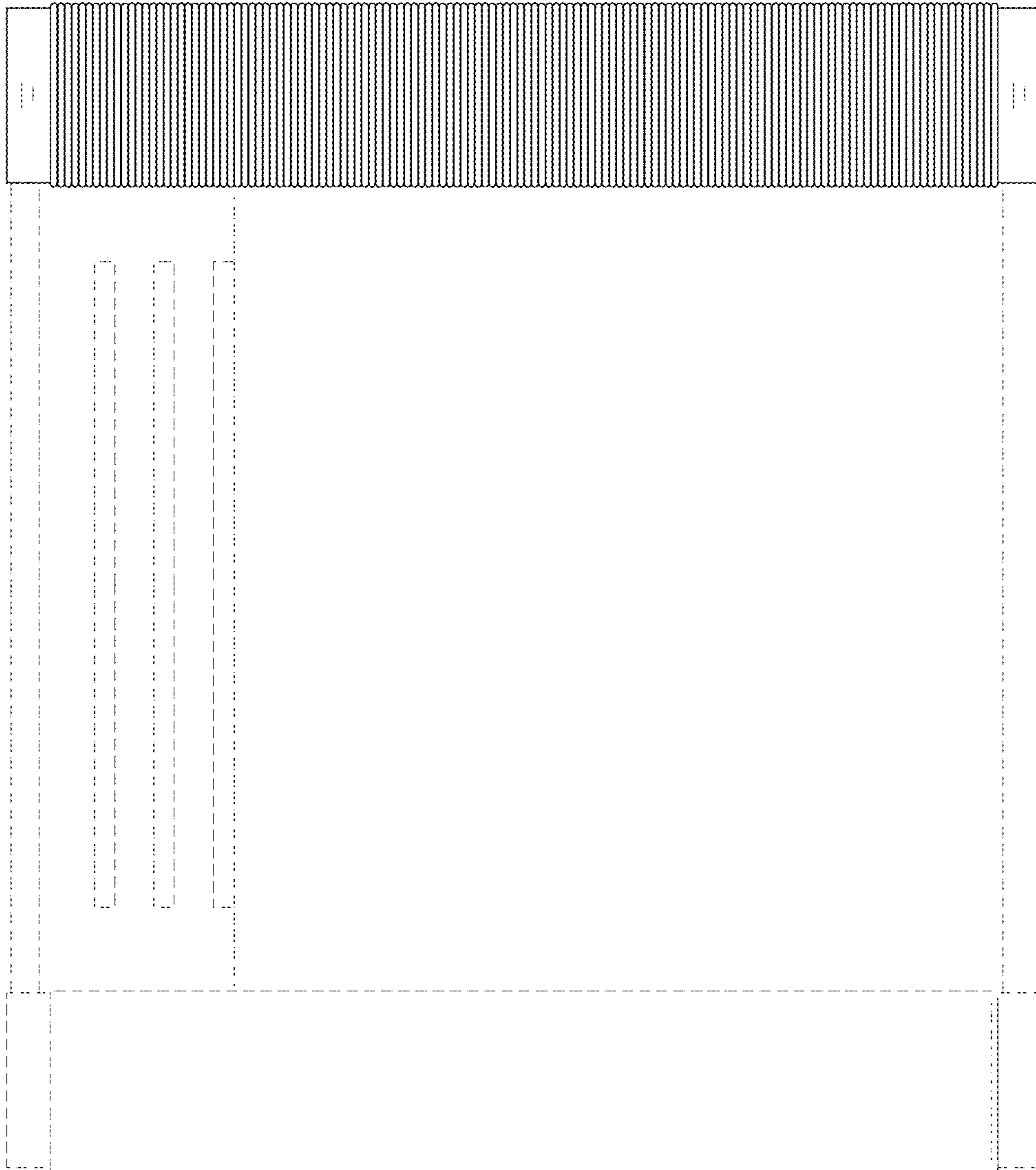

Fig. 6

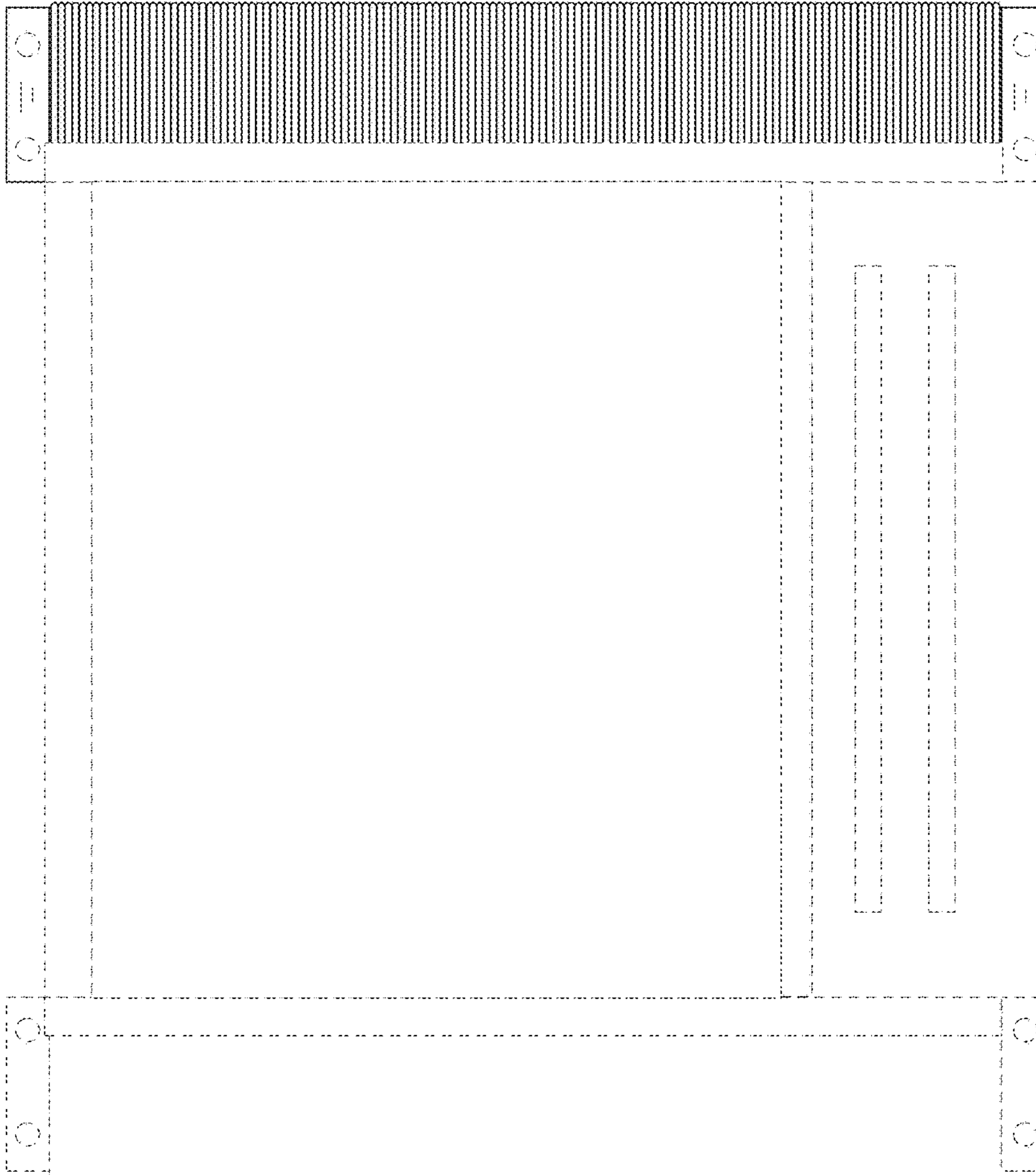

Fig. 7