



US00D807060S

(12) **United States Design Patent** (10) **Patent No.:** **US D807,060 S**
Bunn (45) **Date of Patent:** **** *Jan. 9, 2018**

(54) **SOCK STORAGE AND ORGANIZING HANGER**

(71) Applicant: **Kevin Bunn**, Clayton, NC (US)

(72) Inventor: **Kevin Bunn**, Clayton, NC (US)

(73) Assignee: **Kevin Bunn**

(*) Notice: This patent is subject to a terminal disclaimer.

(**) Term: **15 Years**

(21) Appl. No.: **29/577,689**

(22) Filed: **Sep. 14, 2016**

(51) **LOC (11) Cl.** **06-08**

(52) **U.S. Cl.**
USPC **D6/316; D6/323**

(58) **Field of Classification Search**
USPC D6/315-328, 681.3; D8/367, 370, 371, D8/372, 373, 380; 248/211, 215, 227.1, 248/227.2, 251, 253, 255, 256, 257, 258, 248/259, 301, 304, 323, 324, 339, 690
CPC A47G 25/32; A47G 25/28; A47G 25/743; A47G 25/746; A47G 29/083; A47G 25/06; A47G 25/0607; A47G 25/10; A47G 25/38; A47G 29/08; A47G 1/17; A47G 7/044; A47G 29/00

See application file for complete search history.

(56) **References Cited**

U.S. PATENT DOCUMENTS

D272,231 S *	1/1984	Black, Jr.	D8/349
D442,448 S *	5/2001	Kelleghan	D3/211
D500,602 S *	1/2005	Solowiej	D6/323
D500,669 S *	1/2005	Kelleghan	D8/356
D520,290 S *	5/2006	Curtis	D6/588
D652,636 S *	1/2012	Kalinsky	D6/316
D774,317 S *	12/2016	Taylor	D6/323
2006/0249549 A1 *	11/2006	Giampavolo	A47G 25/1457 223/85

* cited by examiner

Primary Examiner — Lauren Calve

(74) *Attorney, Agent, or Firm* — Williams Intellectual Property; Benjamin F. Williams

(57) **CLAIM**

The ornamental design for a sock storage and organizing hanger, as shown and described.

DESCRIPTION

FIG. 1 is an isometric view of a sock storage and organizing hanger showing my new design; FIG. 2 is front view thereof; FIG. 3 is a rear view thereof; FIG. 4 is a left side view thereof; FIG. 5 is a right side view thereof; FIG. 6 is a top view thereof; and, FIG. 7 is a bottom view thereof.

1 Claim, 5 Drawing Sheets

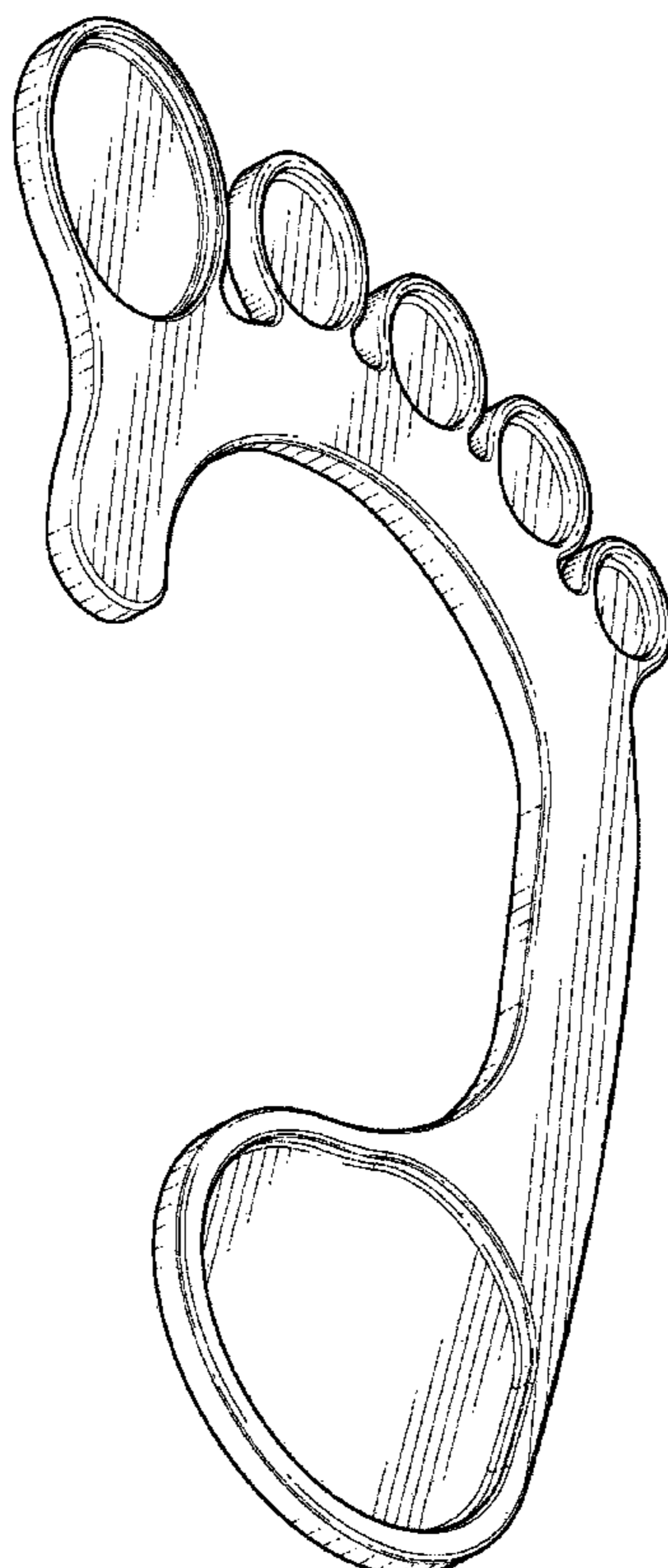

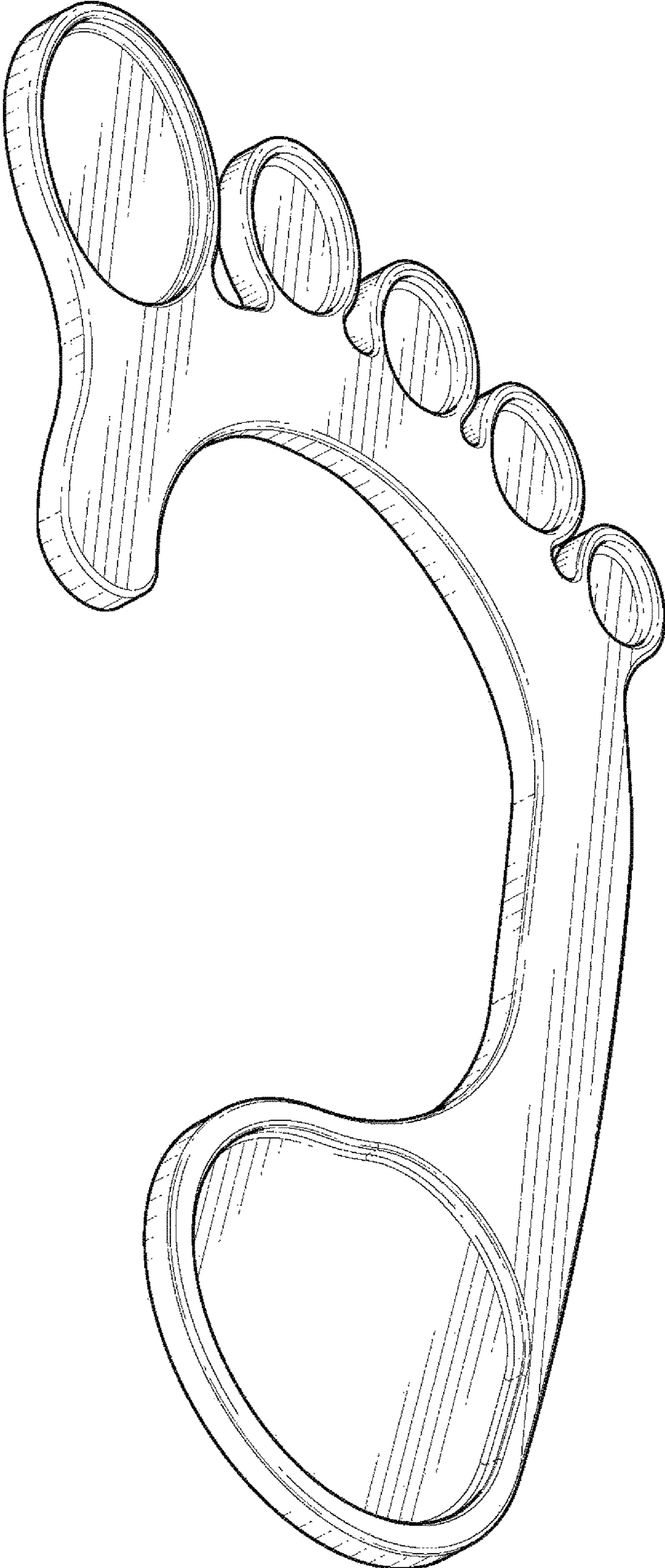

FIG. 1

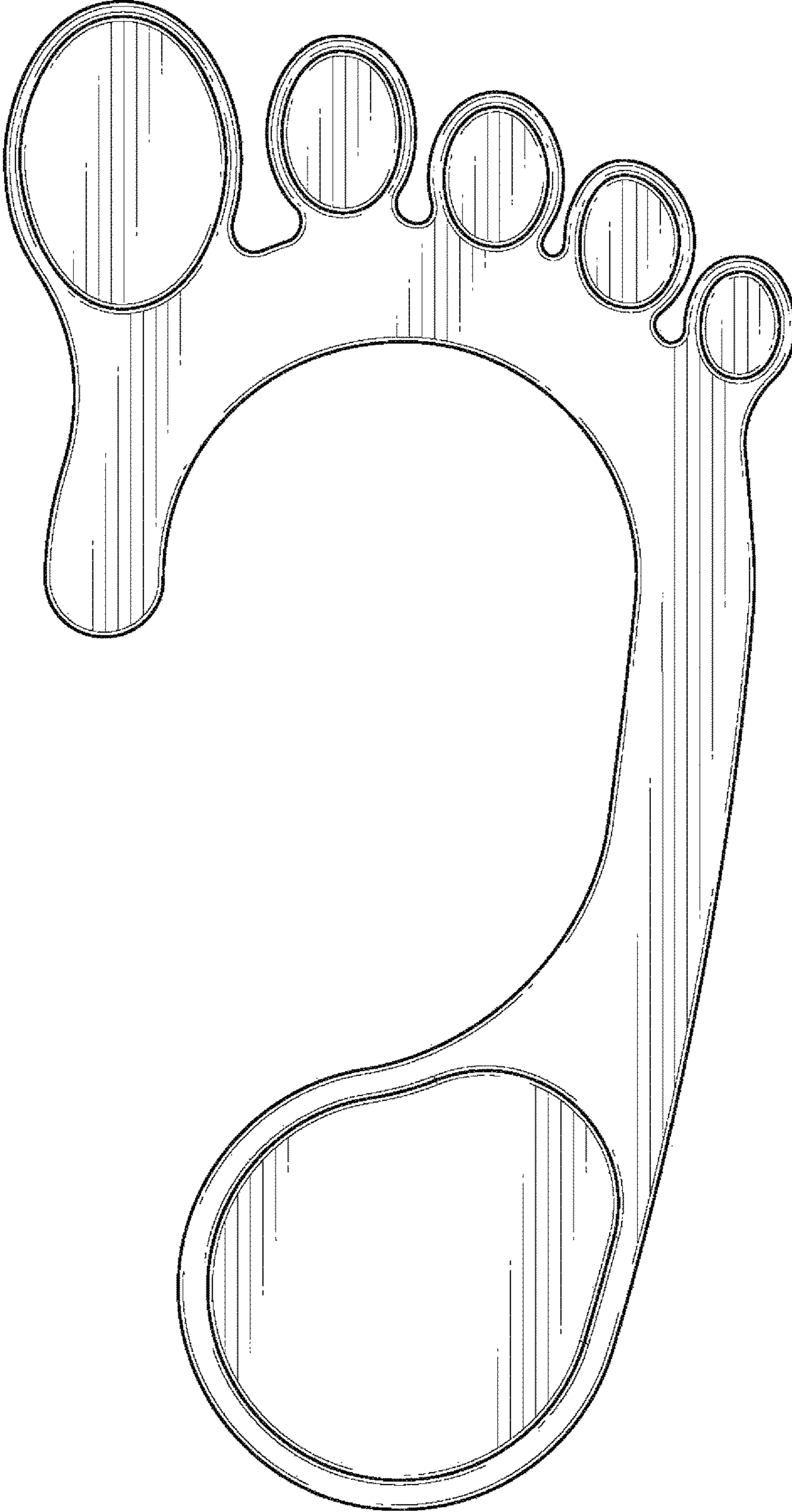

FIG. 2

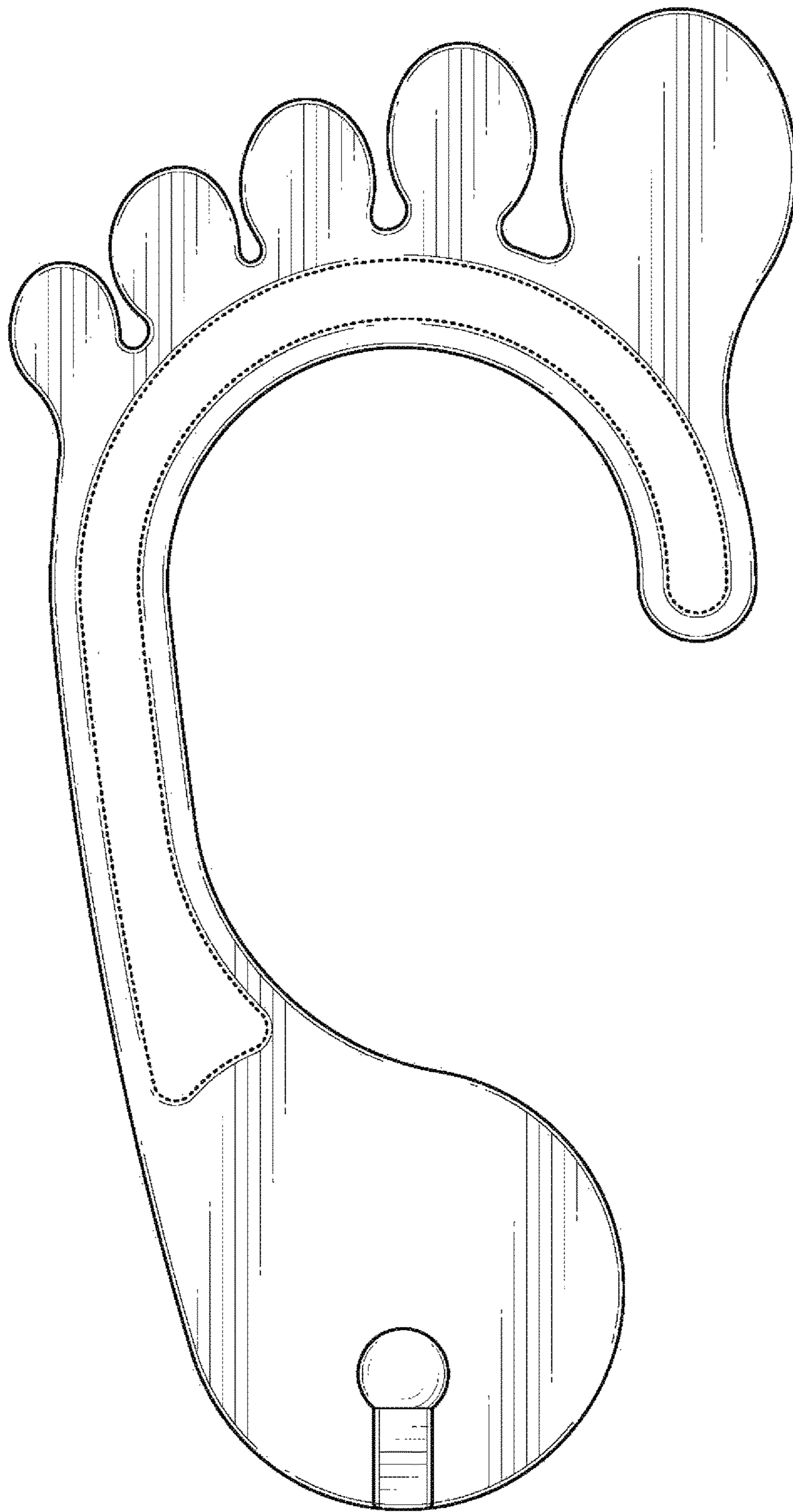

FIG. 3

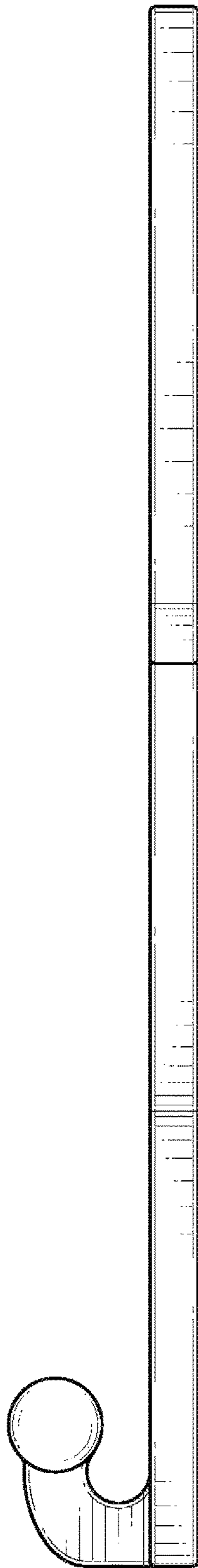

FIG. 4

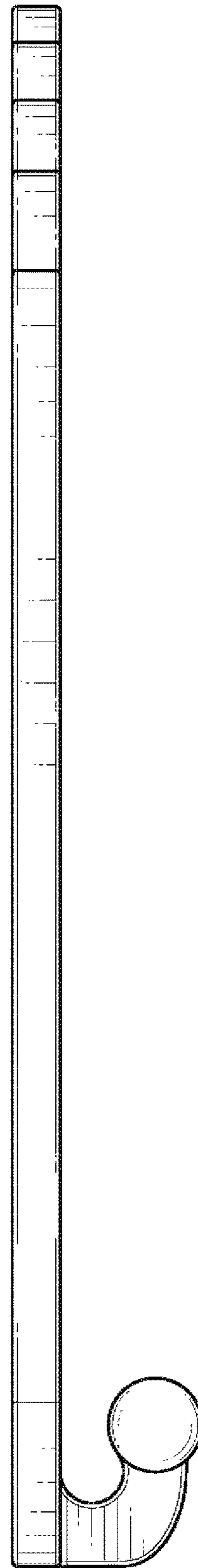

FIG. 5

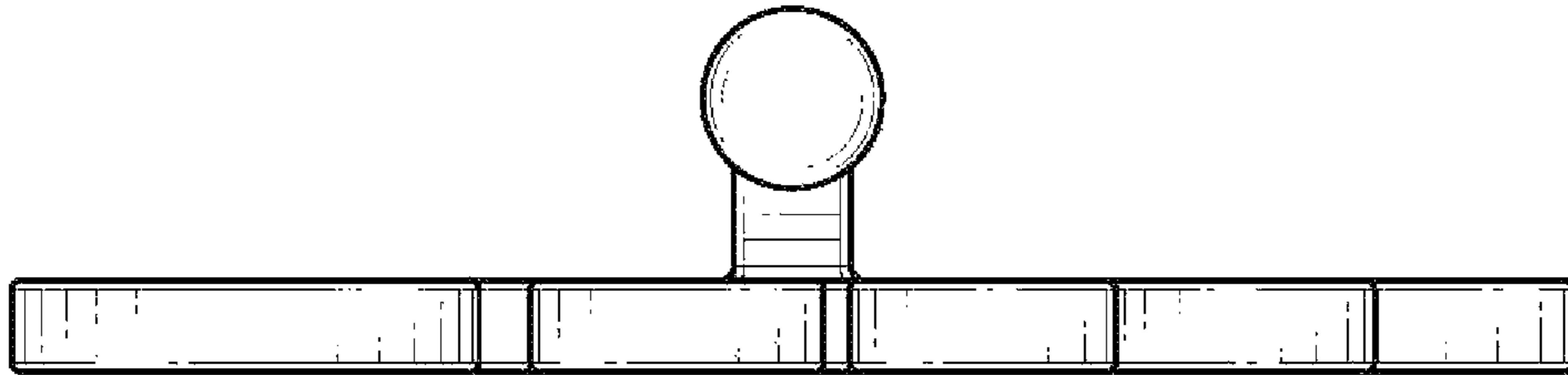

FIG. 6

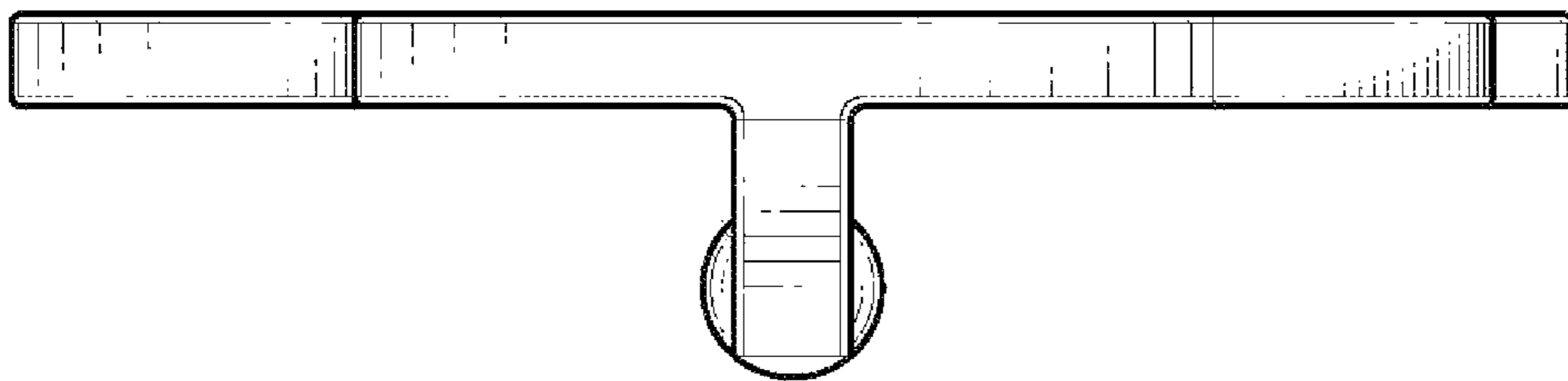

FIG. 7